

OPA2156 36V 超低噪声、高带宽、CMOS、精密轨至轨运算放大器

1 特性

- 超低噪声：10kHz 时为 $3\text{nV}/\sqrt{\text{Hz}}$
- 低失调电压： $\pm 25\mu\text{V}$
- 低失调电压温漂： $\pm 0.5\mu\text{V}/^\circ\text{C}$
- 低偏置电流： $\pm 5\text{pA}$
- 共模抑制：120dB
- 低噪声：10kHz 时为 $3\text{nV}/\sqrt{\text{Hz}}$
- 高带宽：25MHz GBW
- 开环电压增益：154dB
- 高输出电流：100mA
- 轨至轨输入和输出
- 高压摆率：40V/ μs
- 较短的建立时间：600ns（10V 阶跃，0.01%）
- 宽电源电压范围： $\pm 2.25\text{V}$ 至 $\pm 18\text{V}$ ，4.5V 至 36V
- 行业标准封装：
 - SOIC-8 和 VSSOP-8 双列封装

2 应用

- 数据采集 (DAQ)
- 光电二极管跨阻放大器
- 振动监控器模块
- 模拟输入模块
- 高分辨率 ADC 驱动器放大器
- 医疗设备

3 说明

OPA2156 是计划推出的新一代 36V 轨至轨运算放大器中的第一款。

这款器件具有非常低的失调电压 ($\pm 25\mu\text{V}$)、漂移 ($\pm 0.5\mu\text{V}/^\circ\text{C}$) 和低偏置电流 ($\pm 5\text{pA}$)，同时还具有非常低的宽带电压噪声 ($3\text{nV}/\sqrt{\text{Hz}}$)。

OPA2156 拥有独特特性，例如轨至轨输入和输出电压范围、宽带宽 (25MHz)、高输出电流 (100mA) 和高压摆率 (40V/ μs)，是一款功能强大、性能出色的运算放大器，适用于高压精密工业应用中节省电路板空间。

OPA2156 运算放大器可提供 8 引脚 SOIC 和 VSSOP 封装，可在 -40°C 至 $+125^\circ\text{C}$ 的工业温度范围内正常工作。

器件信息⁽¹⁾

器件型号	封装	封装尺寸 (标称值)
OPA2156	SOIC (8)	4.90mm × 3.90mm
	VSSOP (8)	3.00mm × 3.00mm

(1) 如需了解所有可用封装，请参阅数据表末尾的封装选项附录。

低输入电压噪声频谱密度

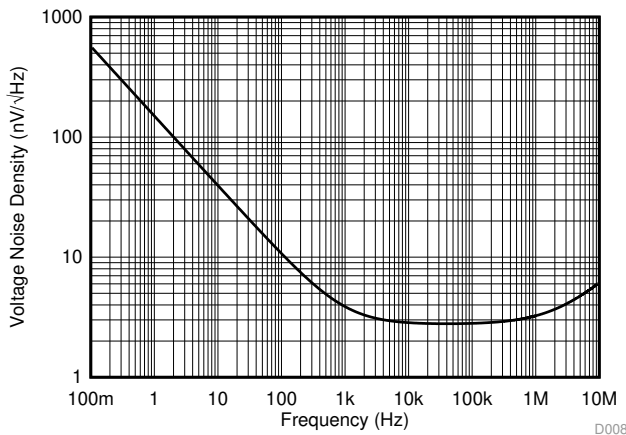

OPA2156 跨阻配置

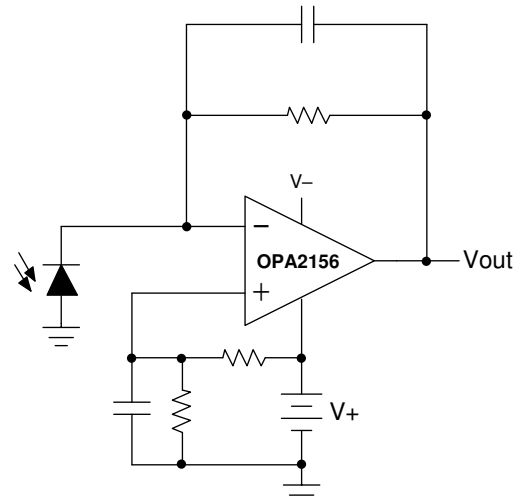

目录

1	特性	1	8	Application and Implementation	20
2	应用	1	8.1	Application Information.....	20
3	说明	1	8.2	Typical Application	21
4	修订历史记录	2	9	Power Supply Recommendations	23
5	Pin Configuration and Functions	3	10	Layout	23
6	Specifications	4	10.1	Layout Guidelines	23
6.1	Absolute Maximum Ratings	4	10.2	Layout Example	24
6.2	ESD Ratings.....	4	11	器件和文档支持	25
6.3	Recommended Operating Conditions	4	11.1	器件支持	25
6.4	Thermal Information: OPA2156	4	11.2	文档支持	25
6.5	Electrical Characteristics	5	11.3	接收文档更新通知	25
6.6	Typical Characteristics	7	11.4	社区资源	25
7	Detailed Description	15	11.5	商标	25
7.1	Overview	15	11.6	静电放电警告	26
7.2	Functional Block Diagram	15	11.7	Glossary	26
7.3	Feature Description.....	15	12	机械、封装和可订购信息	26
7.4	Device Functional Modes.....	19			

4 修订历史记录

注：之前版本的页码可能与当前版本有所不同。

Changes from Revision A (December 2018) to Revision B	Page
• 已添加 向数据表中添加了新的 DGK (VSSOP) 封装和相关内容	1
• 已更改 Figure 8, <i>Input Voltage Noise Spectral Density</i> , to include frequencies up to 10 MHz.....	8
• 已更改 title of input bias and offset current curves (Figures 12 to 14) to specify SOIC package performance	9

Changes from Original (September 2018) to Revision A	Page
• 首次发布生产数据数据表	1

5 Pin Configuration and Functions

**D and DGK Packages
8-Pin SOIC and 8-Pin VSSOP
Top View**

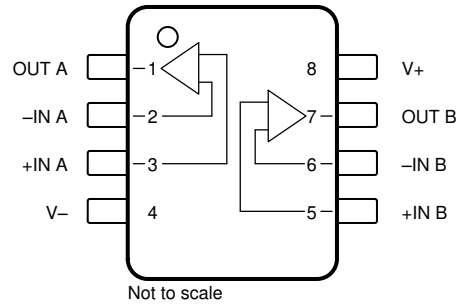

Pin Functions

PIN		I/O	DESCRIPTION
NAME	NO.		
+IN A	3	I	Noninverting input, channel A
+IN B	5	I	Noninverting input, channel B
-IN A	2	I	Inverting input, channel A
-IN B	6	I	Inverting input, channel B
OUT A	1	O	Output, channel A
OUT B	7	O	Output, channel B
V+	8	—	Positive (highest) power supply
V-	4	—	Negative (lowest) power supply

6 Specifications

6.1 Absolute Maximum Ratings

over operating free-air temperature range (unless otherwise noted)⁽¹⁾

			MIN	MAX	UNIT
Supply voltage, $V_S = (V+) - (V-)$			±20 (+40, single supply)		V
Signal input pins	Voltage	Common-mode	(V-) – 0.5	(V+) + 0.5	V
		Differential	0.5		
Current			±10		mA
Output short circuit ⁽²⁾			Continuous		
Temperature	Operating junction		–40	150	°C
	Storage, T_{stg}		–65	150	

- (1) Stresses beyond those listed under *Absolute Maximum Ratings* may cause permanent damage to the device. These are stress ratings only, which do not imply functional operation of the device at these or any other conditions beyond those indicated under *Recommended Operating Conditions*. Exposure to absolute-maximum-rated conditions for extended periods may affect device reliability.
- (2) Short-circuit to ground, one amplifier per package.

6.2 ESD Ratings

			VALUE	UNIT
$V_{(ESD)}$	Electrostatic discharge	Human-body model (HBM), per ANSI/ESDA/JEDEC JS-001 ⁽¹⁾	±3000	V
		Charged-device model (CDM), per JEDEC specification JESD22-C101 ⁽²⁾	±1000	V

- (1) JEDEC document JEP155 states that 500-V HBM allows safe manufacturing with a standard ESD control process.
- (2) JEDEC document JEP157 states that 250-V CDM allows safe manufacturing with a standard ESD control process.

6.3 Recommended Operating Conditions

over operating free-air temperature range (unless otherwise noted)

	MIN	NOM	MAX	UNIT
Supply voltage, $V_S = (V+) - (V-)$	4.5 (±2.25)		36 (±18)	V
Specified temperature (SOIC) ⁽¹⁾	–40		125	°C

- (1) Please see [Thermal Considerations](#) section for information on ambient vs device junction temperature

6.4 Thermal Information: OPA2156

THERMAL METRIC ⁽¹⁾		OPA2156		UNIT
		8 PINS		
		D (SOIC)	DGK (VSSOP)	
$R_{\theta JA}$	Junction-to-ambient thermal resistance	119.2	163.8	°C/W
$R_{\theta JC(top)}$	Junction-to-case(top) thermal resistance	51.1	52.5	°C/W
$R_{\theta JB}$	Junction-to-board thermal resistance	64.7	86.5	°C/W
Ψ_{JT}	Junction-to-top characterization parameter	9.7	5.1	°C/W
Ψ_{JB}	Junction-to-board characterization parameter	63.5	84.7	°C/W

- (1) For more information about traditional and new thermal metrics, see the *Semiconductor and IC Package Thermal Metrics* application report, [SPRA953](#).

6.5 Electrical Characteristics

at $T_A = 25^\circ\text{C}$, $V_S = \pm 2.25\text{V}$ to $\pm 18\text{V}$, $V_{CM} = V_{OUT} = V_S / 2$, and $R_L = 2\text{ k}\Omega$ connected to $V_S / 2$ (unless otherwise noted)

PARAMETER		TEST CONDITIONS		MIN	TYP	MAX	UNIT	
OFFSET VOLTAGE								
V_{OS}	Input offset voltage, PMOS	$T_A = -40^\circ\text{C}$ to $+85^\circ\text{C}$			± 25	± 200	μV	
		$T_A = -40^\circ\text{C}$ to $+125^\circ\text{C}$				± 300	μV	
V_{OS}	Input offset voltage, NMOS	$V_{CM} = (V+) - 1.25\text{ V}$			± 0.25	± 3	mV	
		$V_{CM} = (V+) - 1.25\text{ V}$, $T_A = -40^\circ\text{C}$ to $+125^\circ\text{C}$ (SOIC)						
		$V_{CM} = (V+) - 1.25\text{ V}$, $T_A = -40^\circ\text{C}$ to $+105^\circ\text{C}$ (MSOP)					± 5	mV
dV_{OS}/dT	Input offset voltage drift	PMOS, SOIC	$T_A = -40^\circ\text{C}$ to $+125^\circ\text{C}$		± 0.5	± 3	$\mu\text{V}/^\circ\text{C}$	
		PMOS, MSOP	$T_A = -40^\circ\text{C}$ to $+105^\circ\text{C}$					
		NMOS, $V_{CM} = (V+) - 1.25\text{ V}$	$T_A = -40^\circ\text{C}$ to $+125^\circ\text{C}$		± 1			
PSRR	Power-supply rejection ratio	$T_A = -40^\circ\text{C}$ to $+125^\circ\text{C}$ (SOIC)			± 0.3	± 4.5	$\mu\text{V}/\text{V}$	
		$T_A = -40^\circ\text{C}$ to $+105^\circ\text{C}$ (MSOP)				± 5		
INPUT BIAS CURRENT								
I_B	Input bias current	SOIC			± 5	± 40	pA	
		MSOP			± 5	± 80	pA	
		$T_A = -40^\circ\text{C}$ to $+85^\circ\text{C}$ (SOIC)					± 1.5	nA
		$T_A = -40^\circ\text{C}$ to $+85^\circ\text{C}$ (MSOP)					± 15	nA
		$T_A = -40^\circ\text{C}$ to $+125^\circ\text{C}$						See Typical Characteristics
I_{OS}	Input offset current				± 2	± 40	pA	
		$T_A = -40^\circ\text{C}$ to $+85^\circ\text{C}$ (SOIC)					± 1.5	nA
		$T_A = -40^\circ\text{C}$ to $+85^\circ\text{C}$ (MSOP)					± 2.5	nA
		$T_A = -40^\circ\text{C}$ to $+125^\circ\text{C}$						See Typical Characteristics
NOISE								
E_n	Input voltage noise	$(V-) < V_{CM} < (V+) - 2.25\text{ V}$	$f = 0.1\text{ Hz}$ to 10 Hz		1.9		μV_{PP}	
		$(V+) - 1.25\text{ V} < V_{CM} < (V+)$	$f = 0.1\text{ Hz}$ to 10 Hz		3.4			
e_n	Input voltage noise density	$(V-) < V_{CM} < (V+) - 2.25\text{ V}$	$f = 100\text{ Hz}$		12.0		$\text{nV}/\sqrt{\text{Hz}}$	
			$f = 1\text{ kHz}$		4			
			$f = 10\text{ kHz}$		3.0			
e_n	Input voltage noise density	$(V+) - 1.25\text{ V} < V_{CM} < (V+)$	$f = 100\text{ Hz}$		13.0			
			$f = 1\text{ kHz}$		9.7			
			$f = 10\text{ kHz}$		4.0			
i_n	Input current noise density	$f = 1\text{ kHz}$			19		$\text{fA}/\sqrt{\text{Hz}}$	
INPUT VOLTAGE								
V_{CM}	Common-mode voltage range			$(V-) - 0.1$		$(V+) + 0.1$	V	
CMRR	Common-mode rejection ratio, PMOS	$(V-) < V_{CM} < (V+) - 2.25\text{ V}$, $V_S = \pm 18\text{ V}$		106	120		dB	
CMRR	Common-mode rejection ratio, PMOS	$T_A = -40^\circ\text{C}$ to $+125^\circ\text{C}$ (SOIC)		100				
CMRR	Common-mode rejection ratio, PMOS	$T_A = -40^\circ\text{C}$ to $+105^\circ\text{C}$ (MSOP)						
CMRR	Common-mode rejection ratio, NMOS	$(V+) - 1.25\text{ V} < V_{CM} < (V+)$, $V_S = \pm 18\text{ V}$		82	120			
CMRR	Common-mode rejection ratio, NMOS	$T_A = -40^\circ\text{C}$ to $+125^\circ\text{C}$ (SOIC)		74				
CMRR	Common-mode rejection ratio, NMOS	$T_A = -40^\circ\text{C}$ to $+105^\circ\text{C}$ (MSOP)						

Electrical Characteristics (continued)

 at $T_A = 25^\circ\text{C}$, $V_S = \pm 2.25\text{V}$ to $\pm 18\text{V}$, $V_{CM} = V_{OUT} = V_S / 2$, and $R_L = 2\text{ k}\Omega$ connected to $V_S / 2$ (unless otherwise noted)

PARAMETER		TEST CONDITIONS	MIN	TYP	MAX	UNIT
INPUT IMPEDANCE						
Z_{ID}	Differential		100 9.1			$\text{M}\Omega$ pF
Z_{IC}	Common-mode		6 1.9			$10^{12}\Omega$ pF
OPEN-LOOP GAIN						
A_{OL}	Open-loop voltage gain	$(V_-) + 0.6\text{ V} < V_O < (V_+) - 0.6\text{ V}$, $V_S = \pm 18\text{ V}$ (SOIC)	130	154		dB
		$(V_-) + 0.6\text{ V} < V_O < (V_+) - 0.6\text{ V}$, $V_S = \pm 18\text{ V}$ (MSOP)	128	154		
		$T_A = -40^\circ\text{C}$ to $+85^\circ\text{C}$	126			
FREQUENCY RESPONSE						
GBW	Unity gain bandwidth		20			MHz
	Gain bandwidth product	$G = 100$	25			MHz
SR	Slew rate	$V_S = \pm 18\text{ V}$, $G = -1$, 10-V step	40			$\text{V}/\mu\text{s}$
t_s	Settling time	To 0.01%, $C_L = 20\text{ pF}$	$V_S = \pm 18\text{ V}$, $G = -1$, 10-V step		600	ns
t_{OR}	Overload recovery time	$G = -10$			100	ns
THD+N	Total harmonic distortion + noise	$G = 1$, $f = 1\text{ kHz}$, $V_O = 3.5\text{ V}_{RMS}$	-132			dB
			0.000025 %			
		$G = 1$, $f = 20\text{ kHz}$, $V_O = 3.5\text{ V}_{RMS}$	-126			dB
			0.00005%			
Crosstalk		dc	150			dB
		$f = 100\text{ kHz}$	120			dB
OUTPUT						
V_O	Voltage output swing from power supply		200	250		mV
I_{SC}	Short-circuit current	$V_S = \pm 18\text{ V}$	100			mA
C_L	Capacitive load drive		See Typical Characteristics			pF
Z_O	Open-loop output impedance	$f = 1\text{ MHz}$, $I_O = 0\text{ A}$	25			Ω
POWER SUPPLY						
I_Q	Quiescent current per amplifier	$I_O = 0\text{ A}$	4.4		5.2	mA
			$T_A = -40^\circ\text{C}$ to $+125^\circ\text{C}$ (SOIC)		5.2	mA
			$T_A = -40^\circ\text{C}$ to $+105^\circ\text{C}$ (MSOP)			mA
TEMPERATURE						
	Thermal protection		170			$^\circ\text{C}$
	Thermal hysteresis		15			$^\circ\text{C}$

6.6 Typical Characteristics

表 1. Table of Graphs

DESCRIPTION	FIGURE
Offset Voltage Production Distribution	图 1
Offset Voltage vs Temperature (PMOS)	图 2
Offset Voltage vs Temperature (NMOS)	图 3
Offset Voltage vs Power Supply	图 4
Offset Voltage vs Common-Mode Voltage	图 5
Offset Voltage vs Common-Mode Voltage in Transition Region	图 6
Offset Voltage Drift	图 7
Input Voltage Noise Spectral Density	图 8
0.1-Hz to 10-Hz Noise	图 9
THD+N vs Frequency	图 10
THD+N vs Output Amplitude	图 11
Input Bias and Offset Current vs Common-Mode Voltage	图 12
Input Bias and Offset Current vs Temperature	图 13
Input Bias and Offset Current vs Temperature	图 14
Open-Loop Output Impedance vs Frequency	图 15
Maximum Output Voltage vs Frequency	图 16
Open-Loop Gain and Phase Vs Frequency	图 17
Open-Loop Gain vs Temperature	图 18
Closed-Loop Gain vs Frequency	图 19
CMRR vs Frequency	图 20
PSRR vs Frequency	图 21
CMRR vs Temperature	图 22
PSRR vs Temperature	图 23
Positive Output Voltage vs Output Current	图 24
Negative Output Voltage vs Output Current	图 26
Short-Circuit Current vs Temperature	图 25
No Phase Reversal	图 27
Phase Margin vs Capacitive Load	图 28
Small-Signal Overshoot vs Capacitive Load (G = -1)	图 29
Small-Signal Overshoot vs Capacitive Load (G = +1)	图 30
Settling Time	图 31
Negative Overload Recovery	图 32
Positive Overload Recovery	图 33
Small-Signal Step Response (Noninverting)	图 34
Small-Signal Step Response (Inverting)	图 35
Large-Signal Step Response (Noninverting)	图 36
Large-Signal Step Response (Inverting)	图 37
Quiescent Current vs Supply Voltage	图 38
Quiescent Current vs Temperature	图 39
Channel Separation vs Frequency	图 40
EMIRR vs Frequency	图 41

at $T_A = 25^\circ\text{C}$, $V_S = \pm 18\text{ V}$, $V_{CM} = V_S / 2$, $R_L = 10\text{ k}\Omega$ connected to $V_S / 2$, and $C_L = 30\text{ pF}$ (unless otherwise noted)



图 1. Offset Voltage Production Distribution



图 2. Offset Voltage vs Temperature (PMOS)

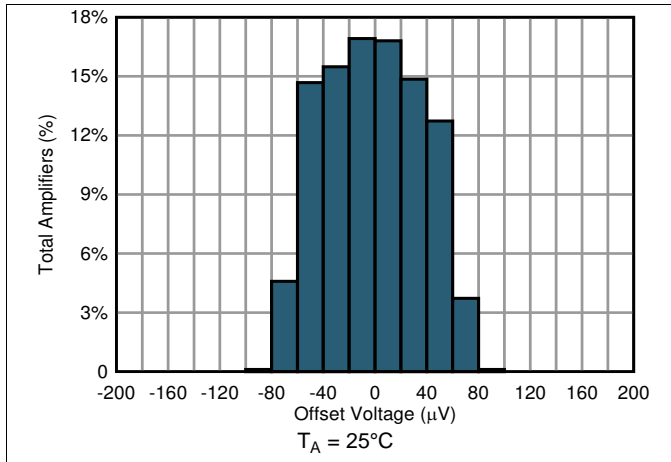

图 3. Offset Voltage vs Temperature (NMOS)

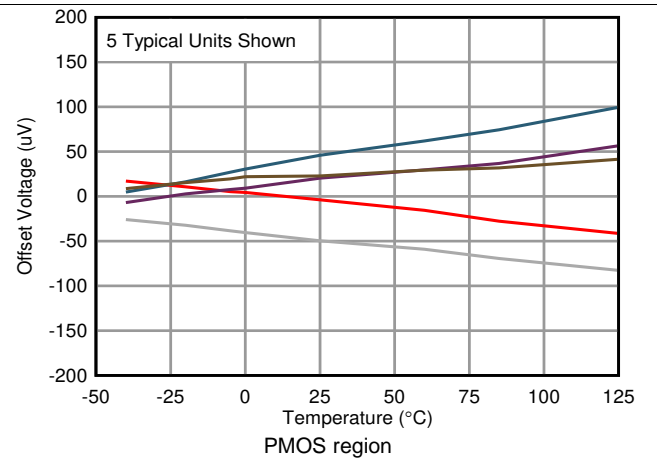

图 4. Offset Voltage vs Power Supply

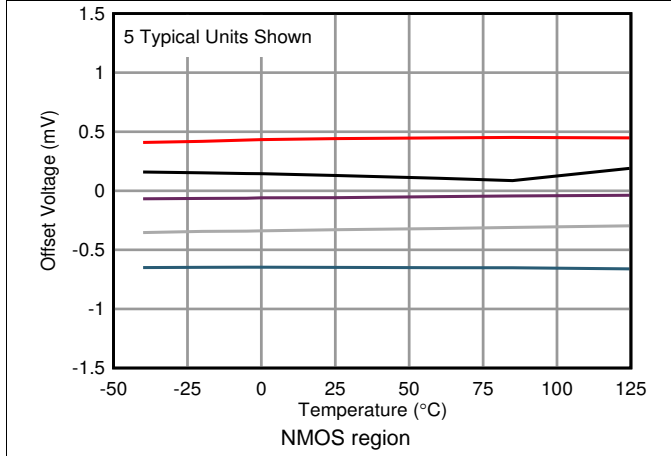

图 5. Offset Voltage vs Common-Mode Voltage

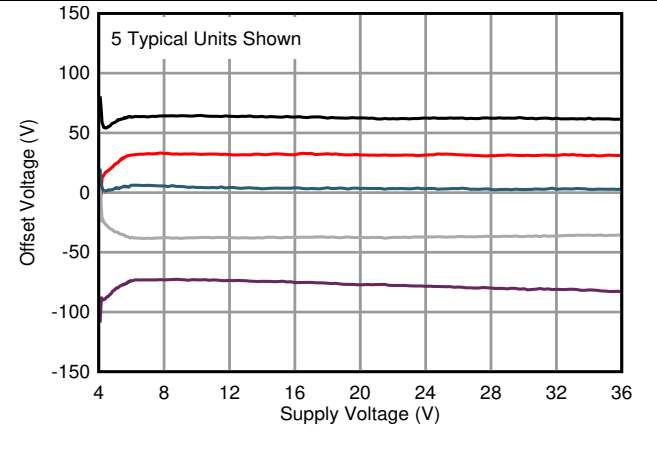

图 6. Offset Voltage vs Common-Mode Voltage in Transition Region

at $T_A = 25^\circ\text{C}$, $V_S = \pm 18\text{ V}$, $V_{CM} = V_S / 2$, $R_L = 10\text{ k}\Omega$ connected to $V_S / 2$, and $C_L = 30\text{ pF}$ (unless otherwise noted)

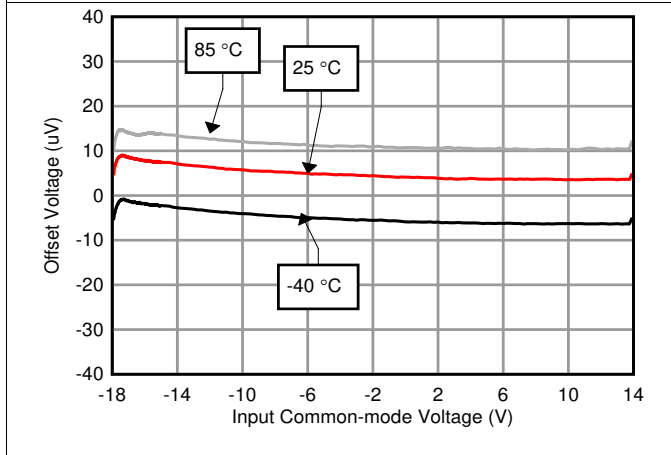

图 7. Offset Voltage Drift

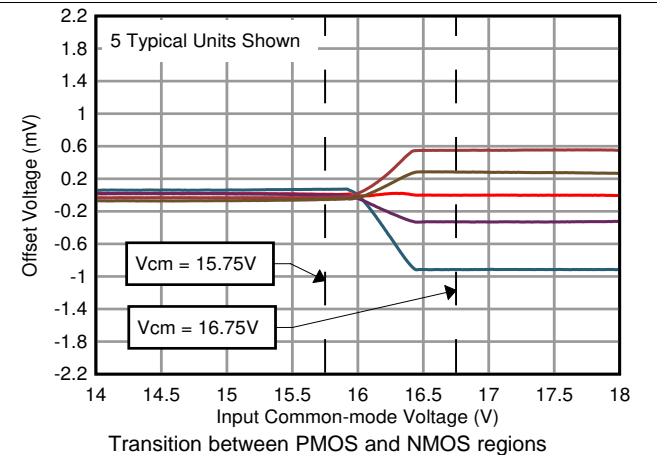

图 8. Input Voltage Noise Spectral Density

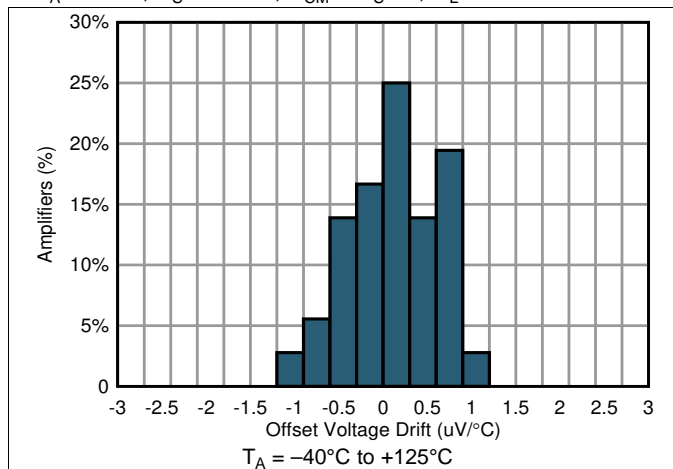

图 9. 0.1-Hz to 10-Hz Noise

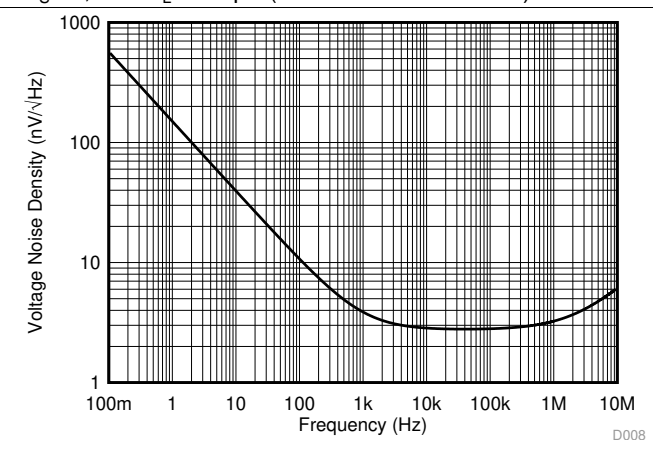

图 10. THD+N vs Frequency

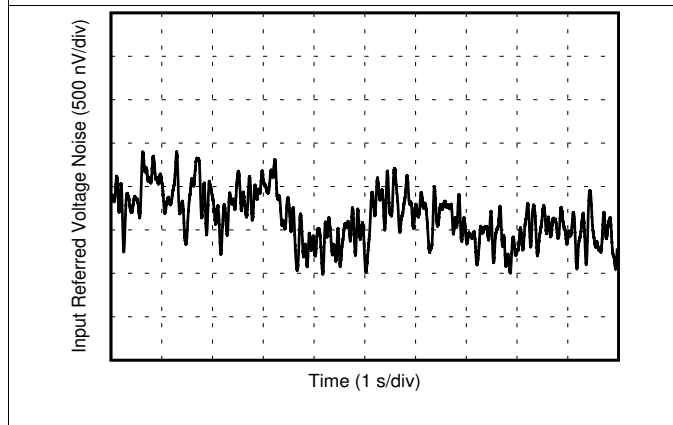

图 11. THD+N vs Output Amplitude

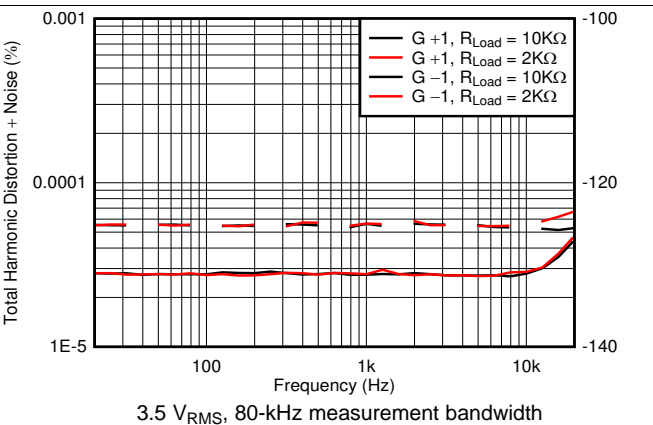

图 12. Input Bias and Offset Current vs Common-Mode Voltage (SOIC)

at $T_A = 25^\circ\text{C}$, $V_S = \pm 18\text{ V}$, $V_{CM} = V_S / 2$, $R_L = 10\text{ k}\Omega$ connected to $V_S / 2$, and $C_L = 30\text{ pF}$ (unless otherwise noted)

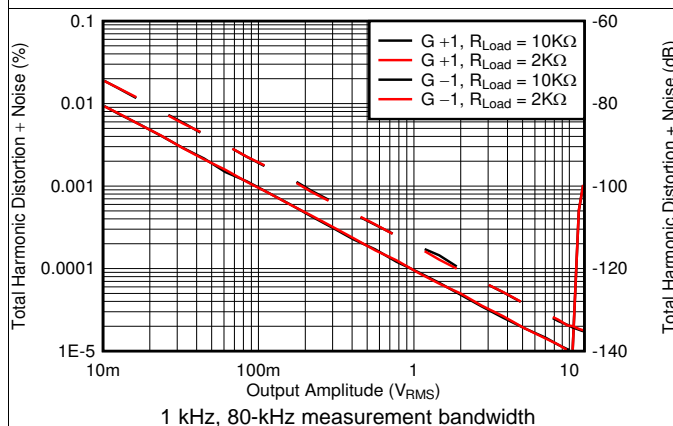

图 13. Input Bias and Offset Current vs Temperature (SOIC)

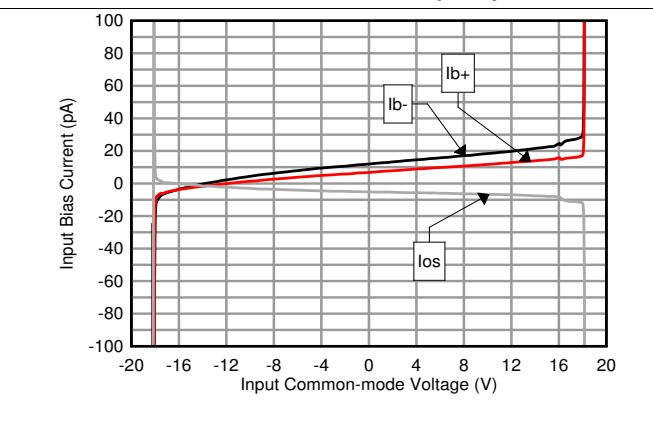

图 14. Input Bias and Offset Current vs Temperature (SOIC)

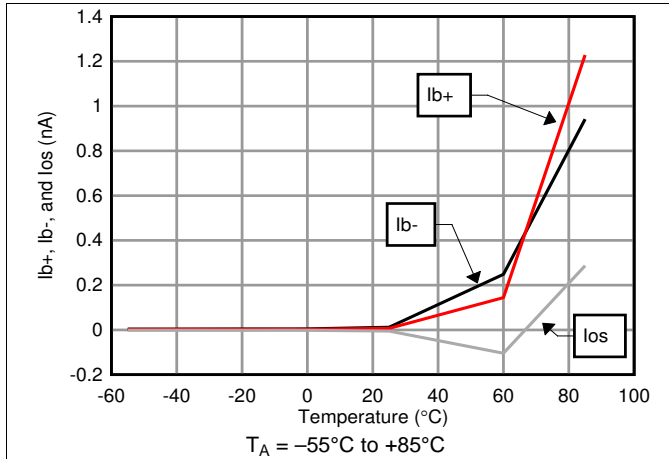

图 15. Open-Loop Output Impedance vs Frequency

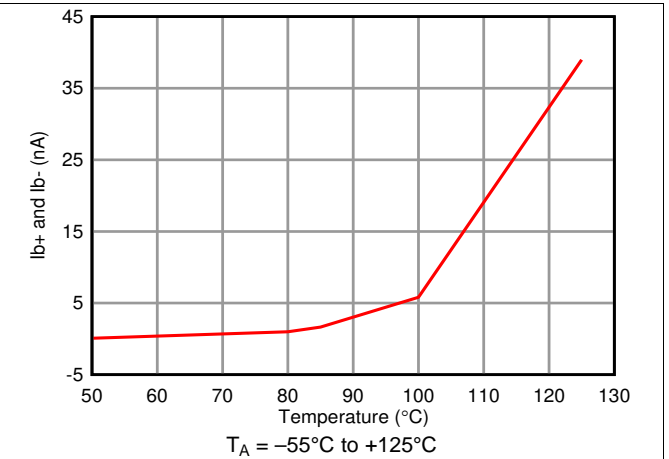

图 16. Maximum Output Voltage vs Frequency

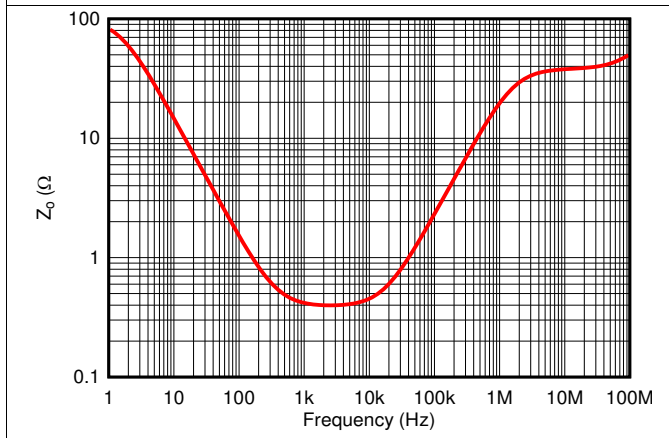

图 17. Open-Loop Gain and Phase vs Frequency

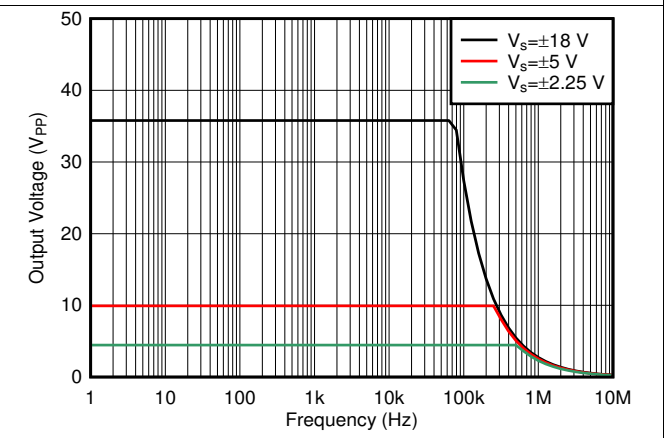

图 18. Open-Loop Gain vs Temperature

at $T_A = 25^\circ\text{C}$, $V_S = \pm 18\text{ V}$, $V_{CM} = V_S / 2$, $R_L = 10\text{ k}\Omega$ connected to $V_S / 2$, and $C_L = 30\text{ pF}$ (unless otherwise noted)

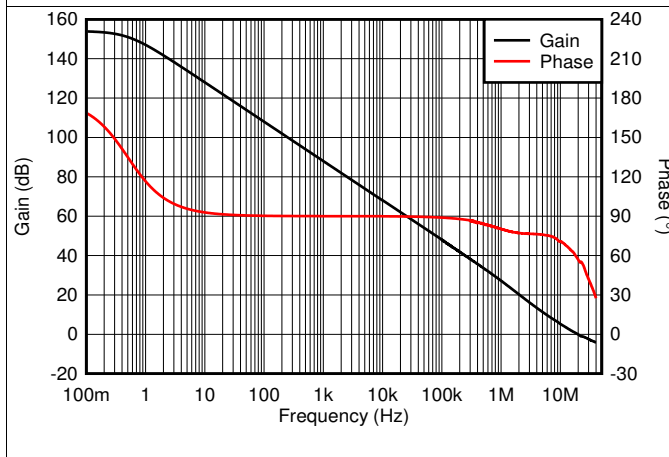

at $T_A = 25^\circ\text{C}$, $V_S = \pm 18\text{ V}$, $V_{CM} = V_S / 2$, $R_L = 10\text{ k}\Omega$ connected to $V_S / 2$, and $C_L = 30\text{ pF}$ (unless otherwise noted)

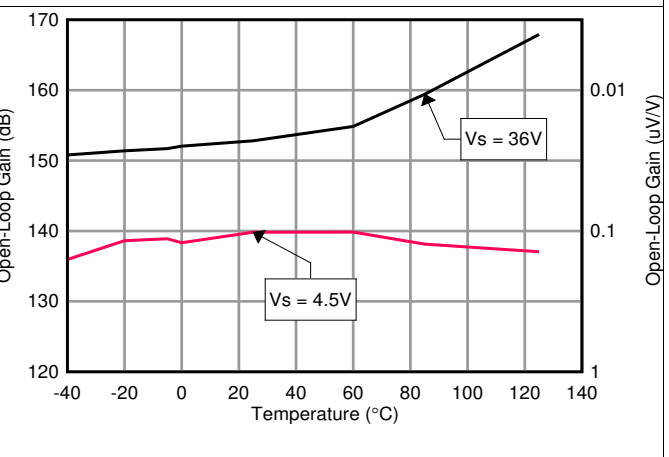
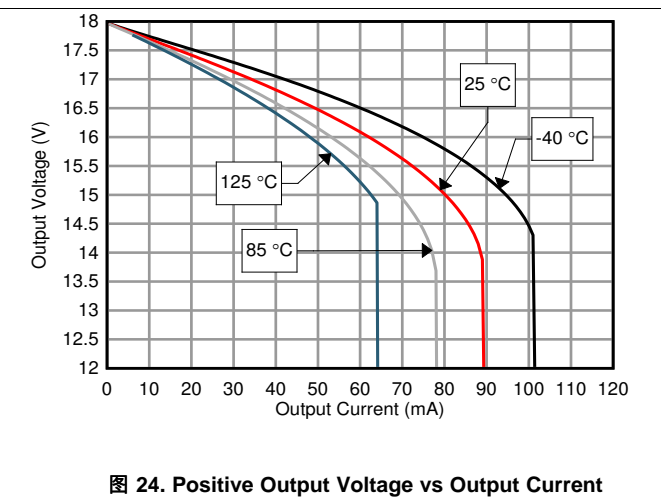
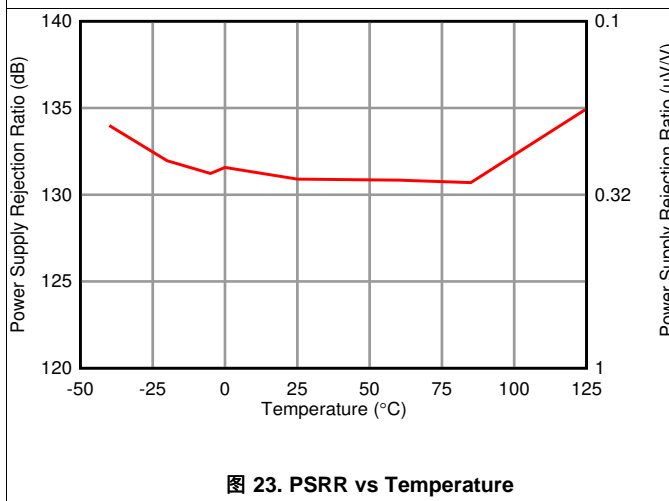
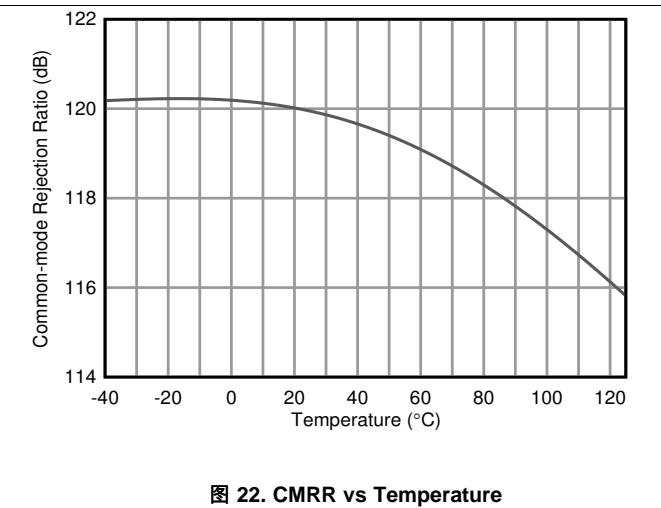
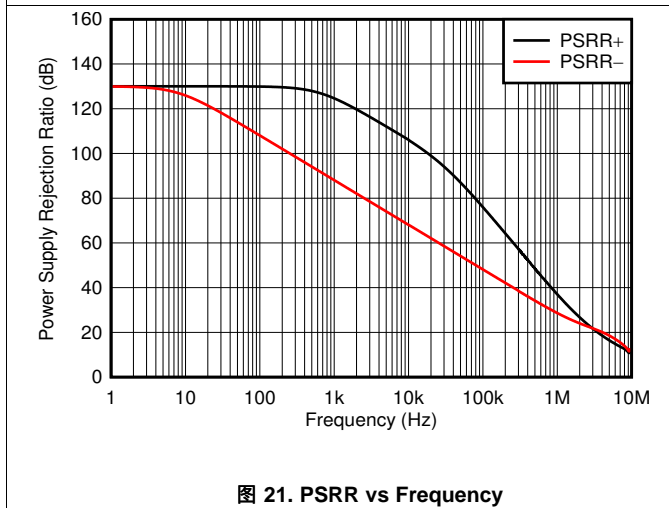
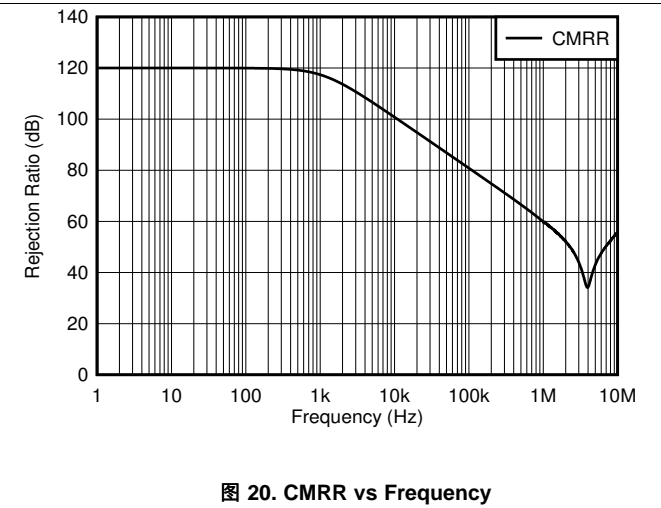
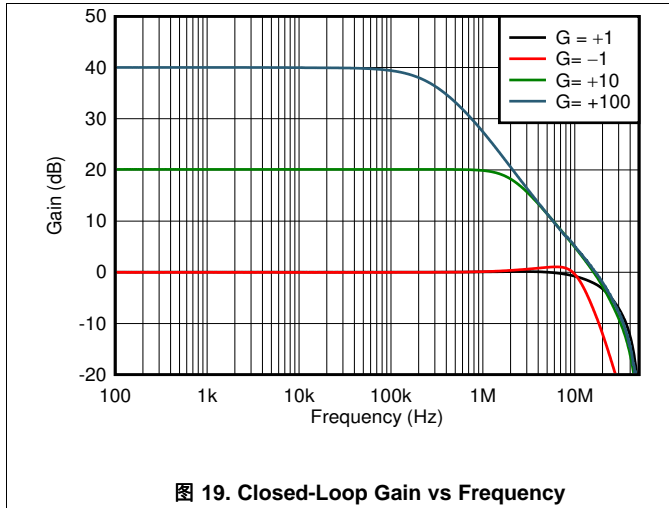
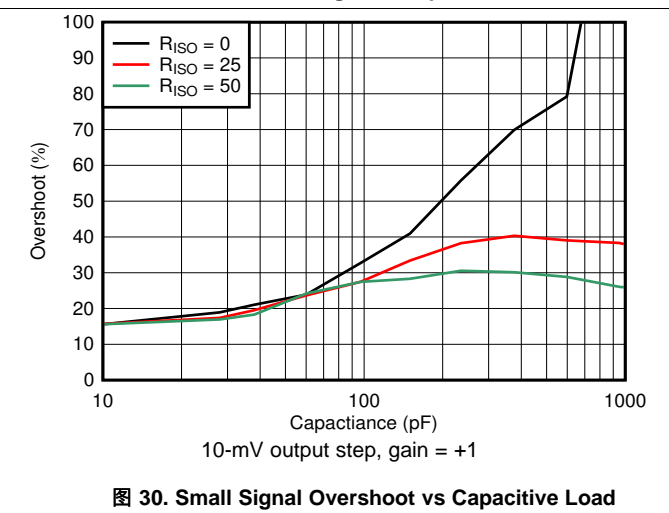
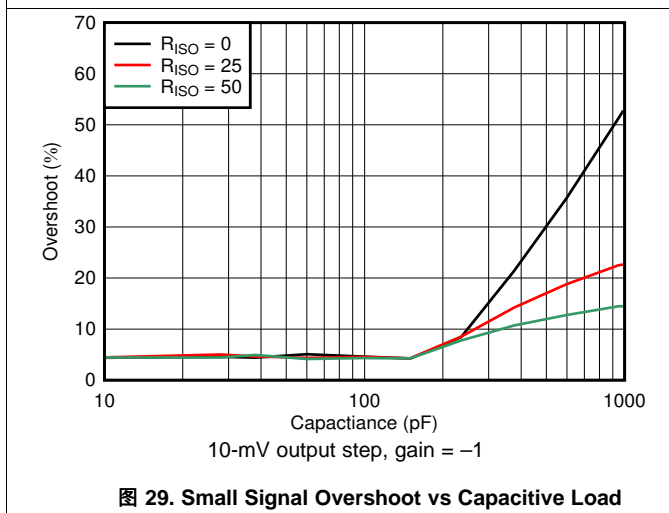
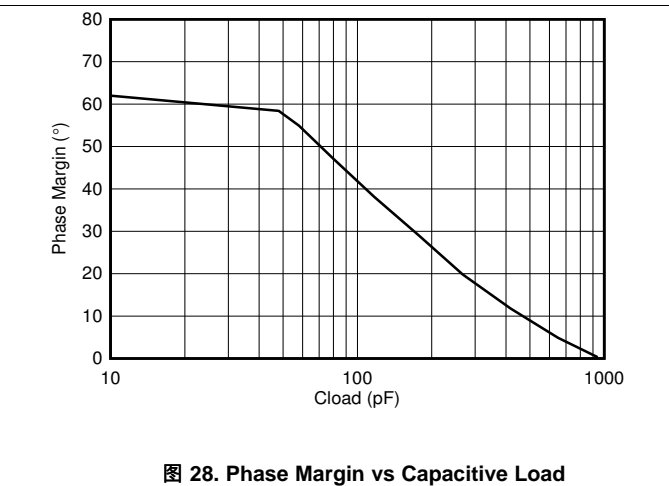
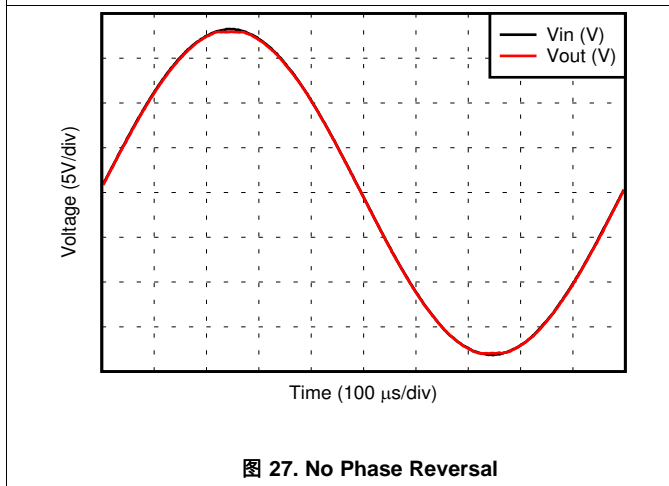
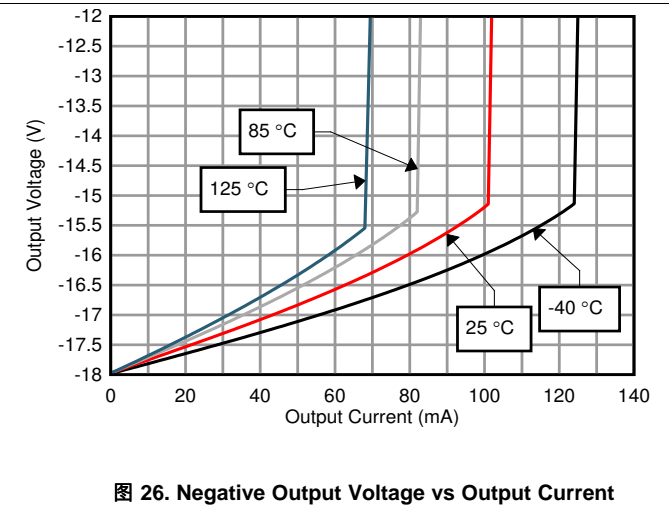
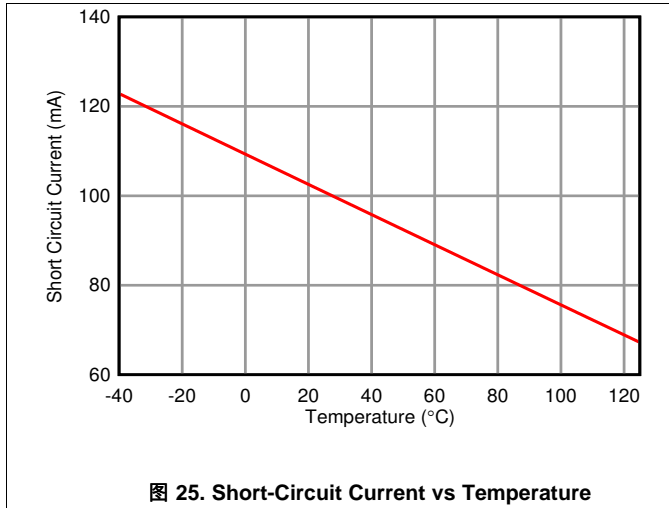

at $T_A = 25^\circ\text{C}$, $V_S = \pm 18\text{ V}$, $V_{CM} = V_S / 2$, $R_L = 10\text{ k}\Omega$ connected to $V_S / 2$, and $C_L = 30\text{ pF}$ (unless otherwise noted)

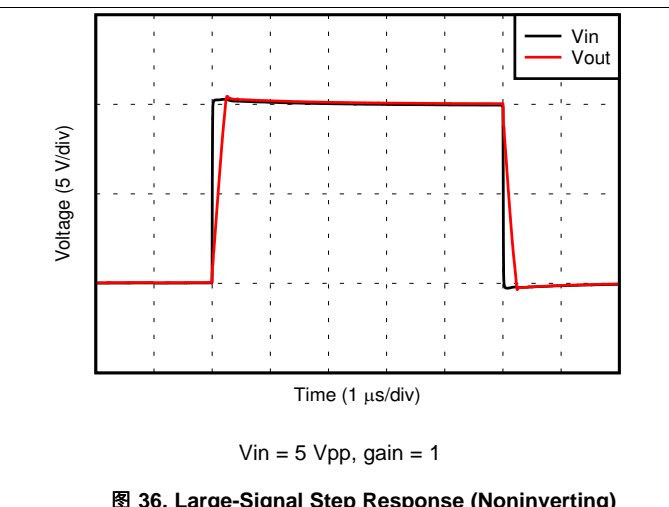
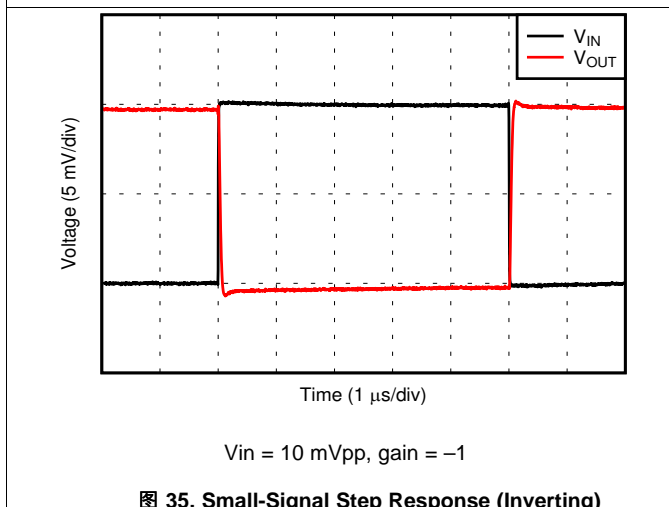
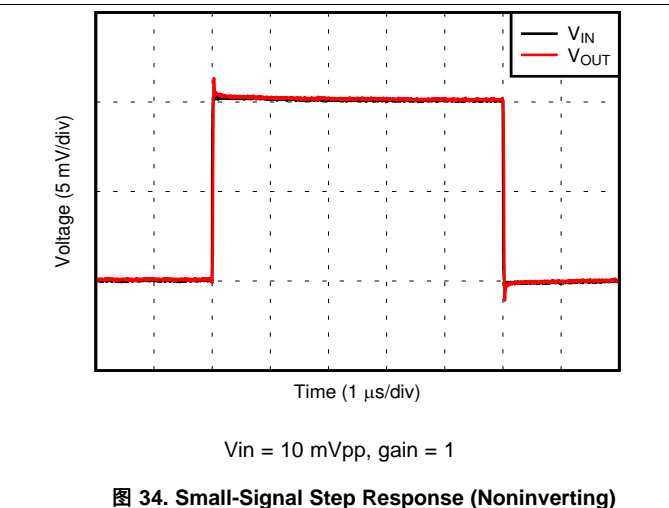
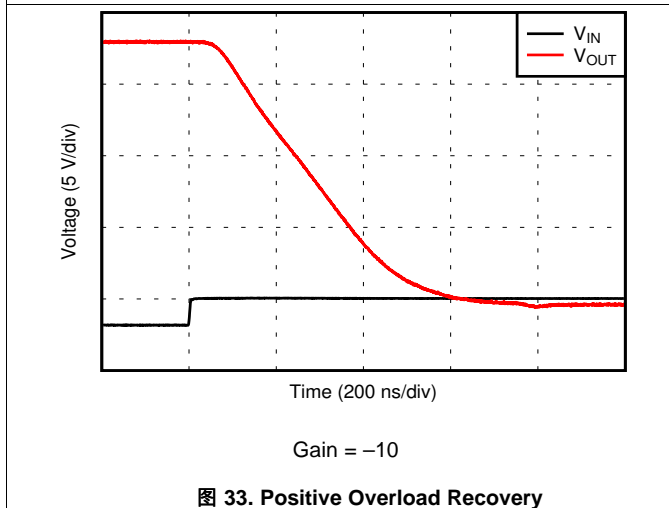
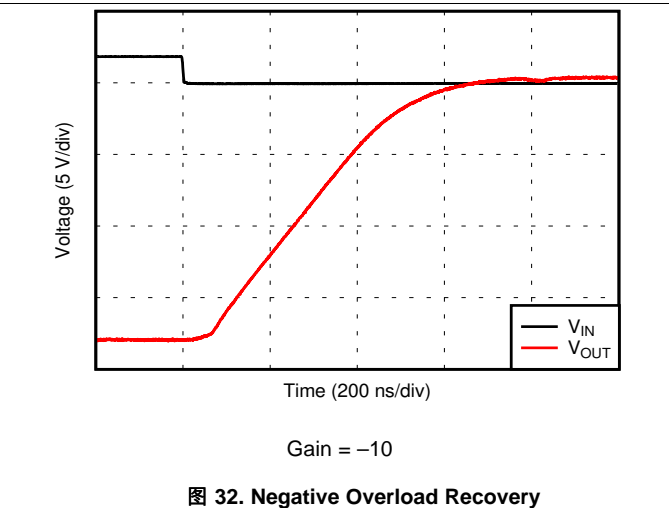
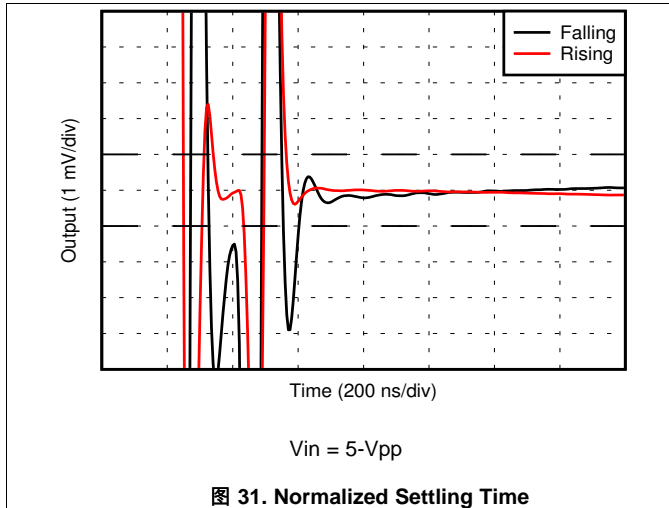

at $T_A = 25^\circ\text{C}$, $V_S = \pm 18\text{ V}$, $V_{CM} = V_S / 2$, $R_L = 10\text{ k}\Omega$ connected to $V_S / 2$, and $C_L = 30\text{ pF}$ (unless otherwise noted)

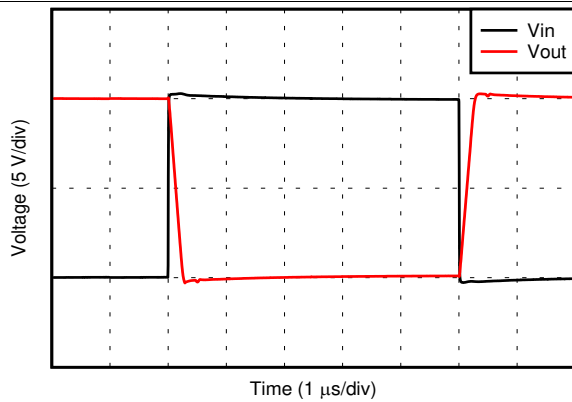

$V_{in} = 5\text{ Vpp}$, gain = -1

图 37. Large Signal Step Response (Inverting)



图 38. Quiescent Current vs Supply Voltage



图 39. Quiescent Current vs Temperature

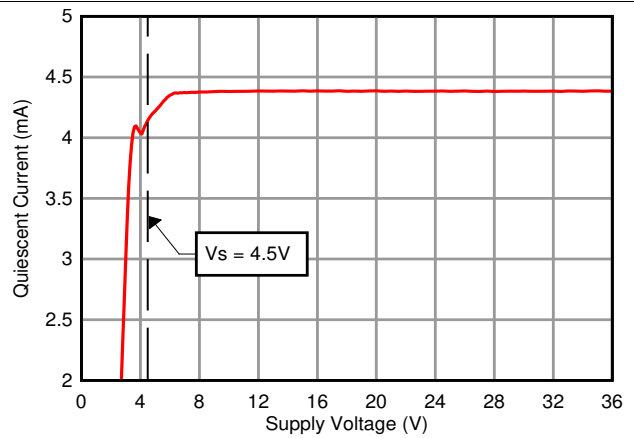

图 40. Channel Separation vs Frequency

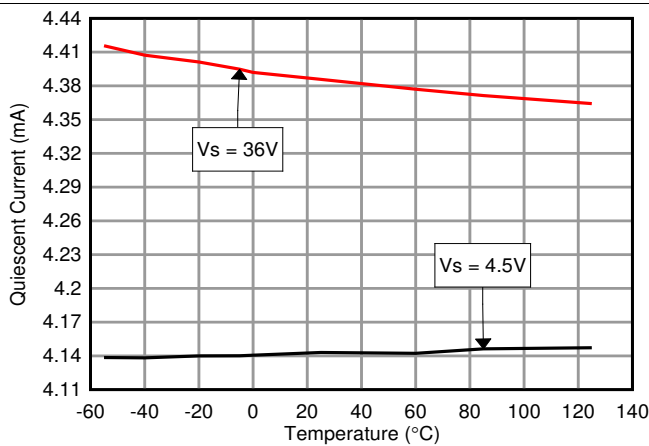

图 41. EMIRR vs Frequency

7 Detailed Description

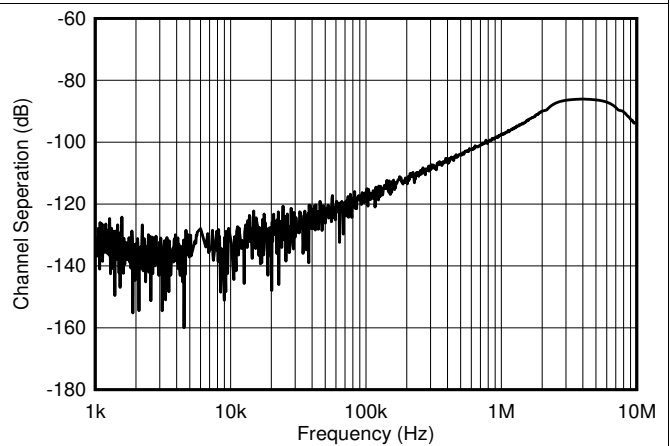
7.1 Overview

The OPA2156 is laser trimmed to improve offset and uses a three-gain-stage architecture to achieve very low noise and distortion. The *Functional Block Diagram* shows a simplified schematic of the OPA2156 (one channel shown). The device consists of a low noise input stage and feed-forward pathway coupled to a high-current output stage. This topology exhibits superior distortion performance under a wide range of loading conditions compared to other operational amplifiers.

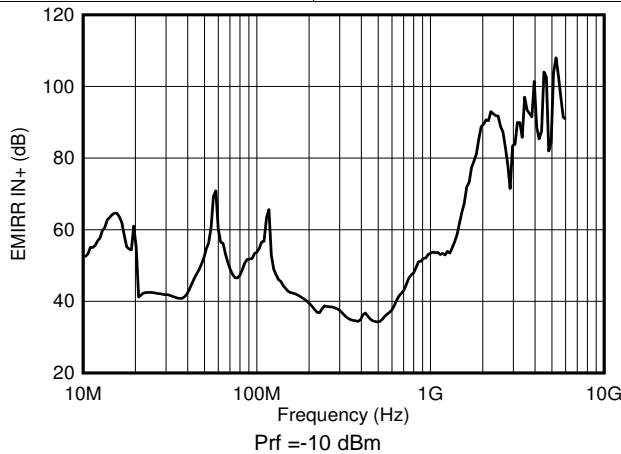
7.2 Functional Block Diagram

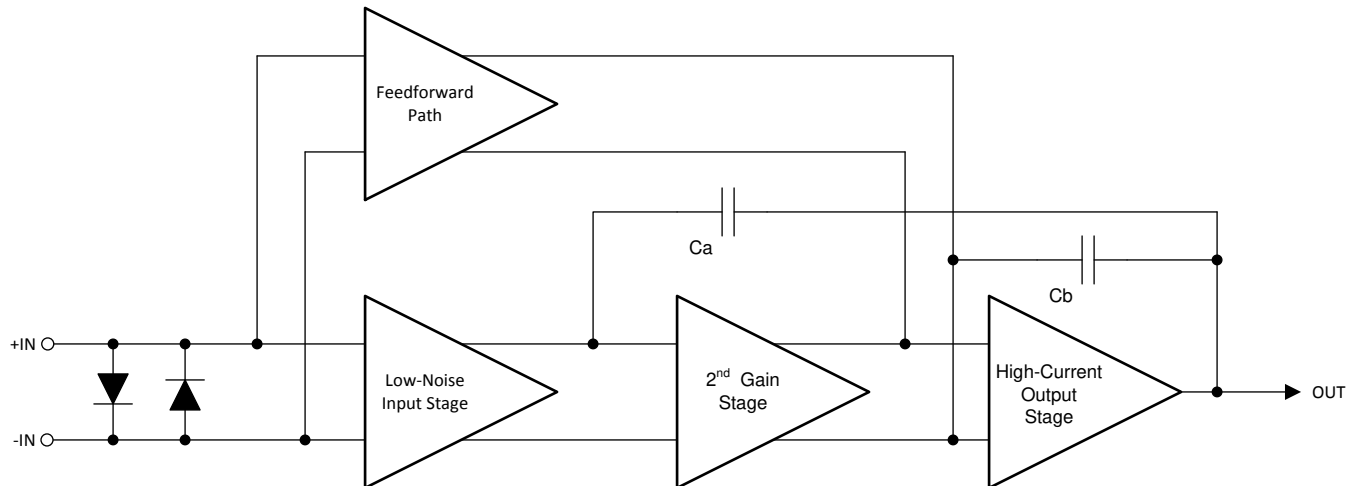

7.3 Feature Description

7.3.1 Phase Reversal Protection

The OPA2156 has internal phase-reversal protection. Many op amps exhibit phase reversal when the input is driven beyond the linear common-mode range. This condition is most often encountered in noninverting circuits when the input is driven beyond the specified common-mode voltage range, causing the output to reverse into the opposite rail. The input of the OPA2156 prevents phase reversal with excessive common-mode voltage. Instead, the appropriate rail limits the output voltage. This performance is shown in [图 42](#).





图 42. Output Waveform Devoid of Phase Reversal During an Input Overdrive Condition

Feature Description (接下页)

7.3.2 Electrical Overstress

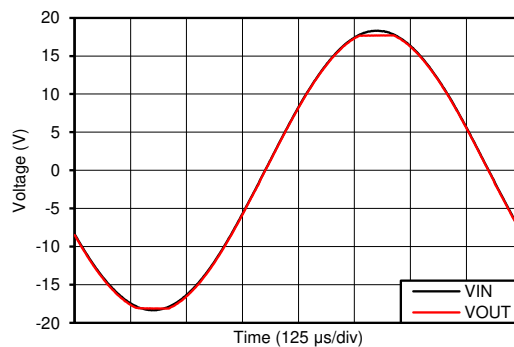
Designers often ask questions about the capability of an operational amplifier to withstand electrical overstress. These questions tend to focus on the device inputs, but can involve the supply voltage pins or even the output pin. Each of these different pin functions have electrical stress limits determined by the voltage breakdown characteristics of the particular semiconductor fabrication process and specific circuits connected to the pin. Additionally, internal electrostatic discharge (ESD) protection is built into these circuits to protect them from accidental ESD events both before and during product assembly.

A good understanding of this basic ESD circuitry and the relevance to an electrical overstress event is helpful.  43 illustrates the ESD circuits contained in the OPA2156 (indicated by the dashed line area). The ESD protection circuitry involves several current-steering diodes connected from the input and output pins and routed back to the internal power-supply lines, where the diodes meet at an absorption device internal to the operational amplifier. This protection circuitry is intended to remain inactive during normal circuit operation.



图 43. Equivalent Internal ESD Circuitry Relative to a Typical Circuit Application

An ESD event produces a short-duration, high-voltage pulse that is transformed into a short-duration, high-current pulse when discharging through a semiconductor device. The ESD protection circuits are designed to provide a current path around the operational amplifier core to prevent damage. The energy absorbed by the protection circuitry is then dissipated as heat.

When an ESD voltage develops across two or more amplifier device pins, current flows through one or more steering diodes. Depending on the path that the current takes, the absorption device can activate. The absorption device has a trigger, or threshold voltage, that is above the normal operating voltage of the OPA2156 but below the device breakdown voltage level. When this threshold is exceeded, the absorption device quickly activates and clamps the voltage across the supply rails to a safe level.

Feature Description (接下页)

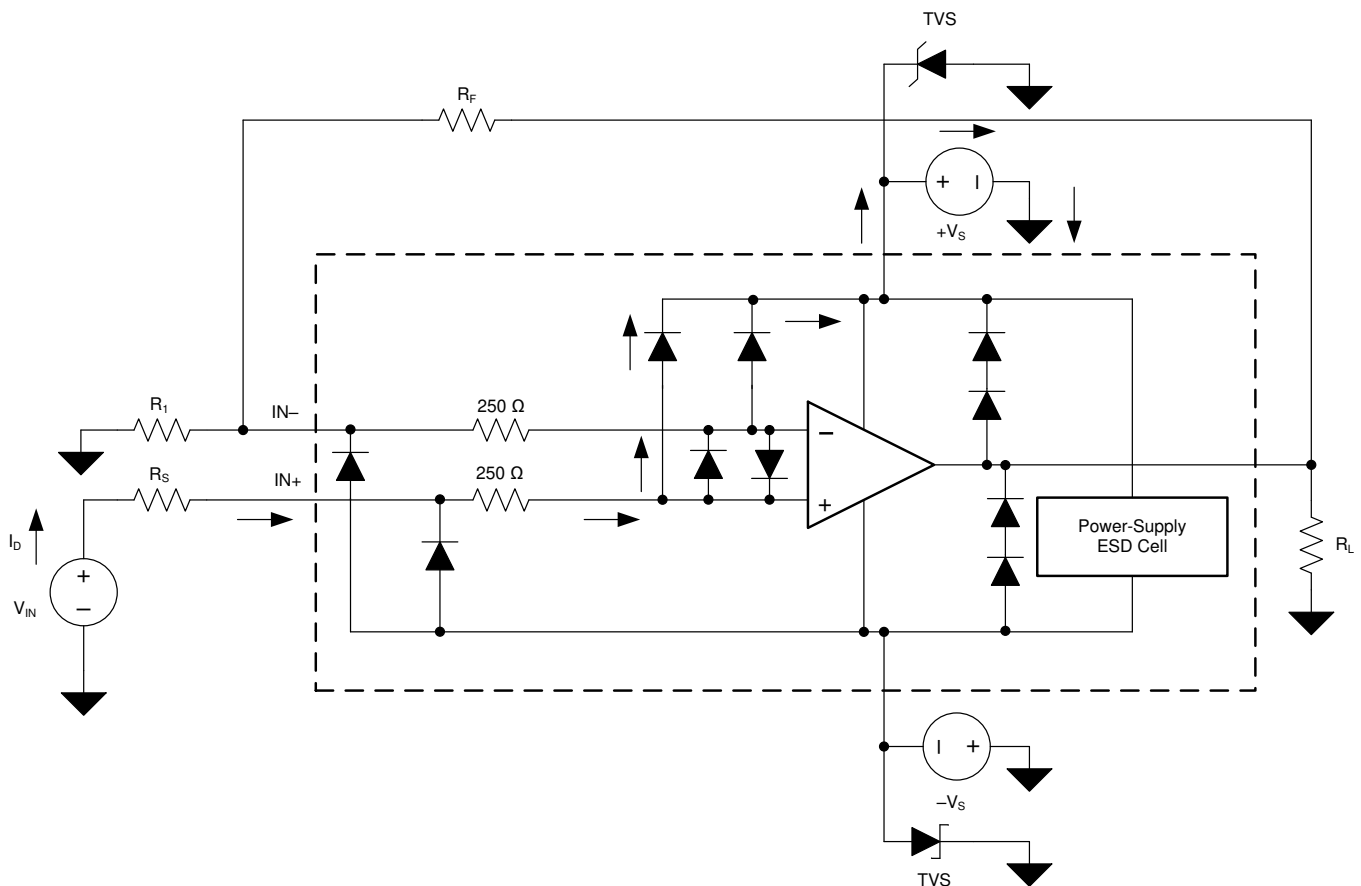
When the operational amplifier connects into a circuit (see [图 43](#)), the ESD protection components are intended to remain inactive and do not become involved in the application circuit operation. However, circumstances may arise where an applied voltage exceeds the operating voltage range of a given pin. If this condition occurs, there is a risk that some internal ESD protection circuits can turn on and conduct current. Any such current flow occurs through steering-diode paths and rarely involves the absorption device.

[图 43](#) shows a specific example where the input voltage (V_{IN}) exceeds the positive supply voltage ($V+$) by 500 mV or more. Much of what happens in the circuit depends on the supply characteristics. If $V+$ can sink the current, one of the upper input steering diodes conducts and directs current to $V+$. Excessively high current levels can flow with increasingly higher V_{IN} . As a result, the data sheet specifications recommend that applications limit the input current to 10 mA.

If the supply is not capable of sinking the current, V_{IN} can begin sourcing current to the operational amplifier and then take over as the source of positive supply voltage. The danger in this case is that the voltage can rise to levels that exceed the operational amplifier absolute maximum ratings.

Another common question involves what happens to the amplifier if an input signal is applied to the input when the power supplies ($V+$ or $V-$) are at 0 V. Again, this question depends on the supply characteristic when at 0 V, or at a level below the input signal amplitude. If the supplies appear as high impedance, then the input source supplies the operational amplifier current through the current-steering diodes. This state is not a normal bias condition; most likely, the amplifier does not operate normally. If the supplies are low impedance, then the current through the steering diodes can become quite high. The current level depends on the ability of the input source to deliver current, and any resistance in the input path.

If there is any uncertainty about the ability of the supply to absorb this current, add external Zener diodes to the supply pins; see [图 43](#). Select the Zener voltage so that the diode does not turn on during normal operation. However, the Zener voltage must be low enough so that the Zener diode conducts if the supply pin begins to rise above the safe-operating, supply-voltage level.

Feature Description (接下页)

7.3.3 Thermal Considerations

Through normal operation the OPA2156 will experience self-heating, a natural increase in the die junction temperature which occurs in every amplifier. This is a result of several factors including the quiescent power consumption, the package’s thermal dissipation, PCB layout and the device operating conditions.

To fully ensure the amplifier will operate without entering thermal shutdown it is important to calculate the approximate junction (die) temperature which can be done using 公式 1.

$$T_J = P_D * \Theta_{JA} + T_A \tag{1}$$

公式 2 shows the approximate junction temperature for the OPA2156 while unloaded with an ambient temperature of 25°C.

$$T_J = (36V * 4.4mA) * 120^\circ C / W + 25^\circ C$$

$$T_J = 44^\circ C \tag{2}$$

For high voltage, high precision amplifiers such as the OPA2156 the junction temperature can easily be 10s of degrees higher than the ambient temperature in a quiescent (unloaded) condition. If the device then begins to drive a heavy load the junction temperature may rise and trip the thermal shutdown circuit. The 图 44 shows the maximum output voltage of the OPA2156 without entering thermal shutdown vs ambient temperature in both a loaded and unloaded condition.



图 44. OPA2156 Thermal Safe Operating Area

Feature Description (接下页)

7.3.4 Thermal Shutdown

The internal power dissipation of any amplifier causes the internal (junction) temperature to rise. This phenomenon is called *self heating*. The OPA2156 has a thermal protection feature that prevents damage from self heating.

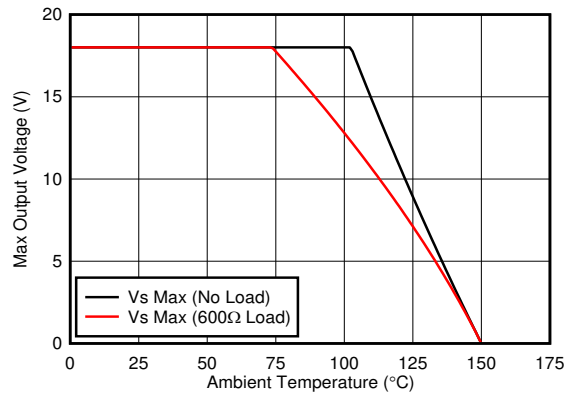
This thermal protection works by monitoring the temperature of the output stage and turning off the op amp output drive for temperatures above approximately 170°C. Thermal protection forces the output to a high-impedance state. The OPA2156 is also designed with approximately 15°C of thermal hysteresis. Thermal hysteresis prevents the output stage from cycling in and out of the high-impedance state. The OPA2156 returns to normal operation when the output stage temperature falls below approximately 155°C.

The absolute maximum junction temperature of the OPA2156 is 150°C. Exceeding the limits shown in the [Absolute Maximum Ratings](#) table may cause damage to the device. Thermal protection triggers at 170°C because of unit-to-unit variance, but does not interfere with device operation up to the absolute maximum ratings. This thermal protection is not designed to prevent this device from exceeding absolute maximum ratings, but rather from excessive thermal overload.

7.3.5 Common-Mode Voltage Range

The OPA2156 is a 36-V, true rail-to-rail input operational amplifier with an input common-mode range that extends 100 mV beyond either supply rail. This wide range is achieved with paralleled complementary N-channel and P-channel differential input pairs. The N-channel pair is active for input voltages close to the positive rail, typically $(V+) - 2.25\text{ V}$ to 100 mV above the positive supply. The P-channel pair is active for inputs from 100 mV below the negative supply to approximately $(V+) - 1.25\text{ V}$. There is a small transition region, typically $(V+) - 2.25\text{ V}$ to $(V+) - 1.25\text{ V}$ in which both input pairs are active. This transition region varies modestly with process variation. Within this region PSRR, CMRR, offset voltage, offset drift, noise, and THD performance are degraded compared to operation outside this region.

To achieve the best performance for two-stage rail-to-rail input amplifiers, avoid the transition region when possible. The OPA2156 uses a precision trim for both the N-channel and P-channel regions. This technique enables significantly lower levels of offset than previous-generation devices, causing variance in the transition region of the input stages to appear exaggerated relative to offset over the full common-mode range.

7.3.6 Overload Recovery

Overload recovery is defined as the time required for the op amp output to recover from a saturated state to a linear state. The output devices of the op amp enter a saturation region when the output voltage exceeds the rated operating voltage, either due to the high input voltage or the high gain. After the device enters the saturation region, the charge carriers in the output devices require time to return back to the linear state. After the charge carriers return back to the linear state, the device begins to slew at the specified slew rate. Thus, the propagation delay in case of an overload condition is the sum of the overload recovery time and the slew time.

7.4 Device Functional Modes

The OPA2156 has a single functional mode and is operational when the power-supply voltage is greater than 4.5 V ($\pm 2.25\text{ V}$). The maximum power supply voltage for the OPA2156 is 36 V ($\pm 18\text{ V}$).

8 Application and Implementation

注

Information in the following applications sections is not part of the TI component specification, and TI does not warrant its accuracy or completeness. TI's customers are responsible for determining suitability of components for their purposes. Customers should validate and test their design implementation to confirm system functionality.

8.1 Application Information

The OPA2156 offers excellent dc precision and ac performance. The device operates with up to 36-V supply rails offering true rail-to-rail input/output, low offset voltage and offset voltage drift, as well as 25-MHz bandwidth and low input bias. These features make the OPA2156 a robust, high-performance operational amplifier for high-voltage industrial applications.

8.1.1 Slew Rate Limit for Input Protection

In control systems for valves or motors, abrupt changes in voltages or currents can cause mechanical damages. By controlling the slew rate of the command voltages into the drive circuits, the load voltages ramps up and down at a safe rate. For symmetrical slew-rate applications (positive slew rate equals negative slew rate), one additional op amp provides slew-rate control for a given analog gain stage. The unique input protection and high output current and slew rate of the OPA2156 make the device an optimal amplifier to achieve slew rate control for both dual- and single-supply systems. [图 45](#) shows the OPA2156 in a slew-rate limit design.



图 45. Slew Rate Limiter Uses One Op Amp



For step-by-step design procedure, circuit schematics, bill of materials, PCB files, simulation results, and test results, refer to [TI Precision Design TIDU026, Slew Rate Limiter Uses One Op Amp](#).

8.2 Typical Application

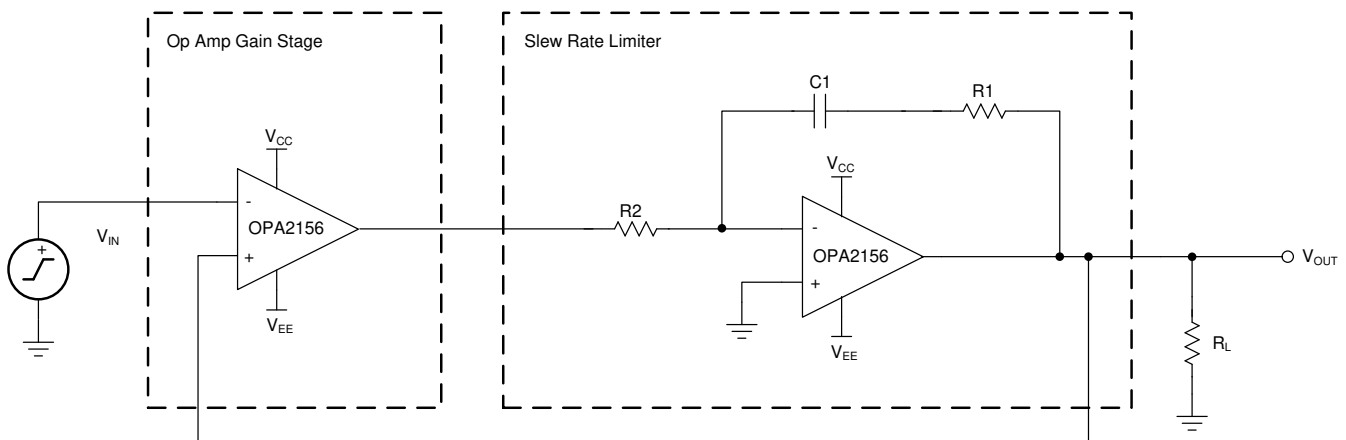
The combination of low input bias, high slew rate and a rail-to-rail input and output enable the OPA2156 to serve as an accurate differential photodiode transimpedance amplifier. This application example shows the design of such a system.



图 46. OPA2156 Configured as a Differential Photodiode Transimpedance Amplifier

8.2.1 Design Requirements

The design requirements for this design are:

- Photodiode current: 0 μA to 90 μA
- Output voltage: -5 V to 5 V
- Supply voltage: $\pm 12\text{ V}$
- Filter cutoff frequency: 1 MHz

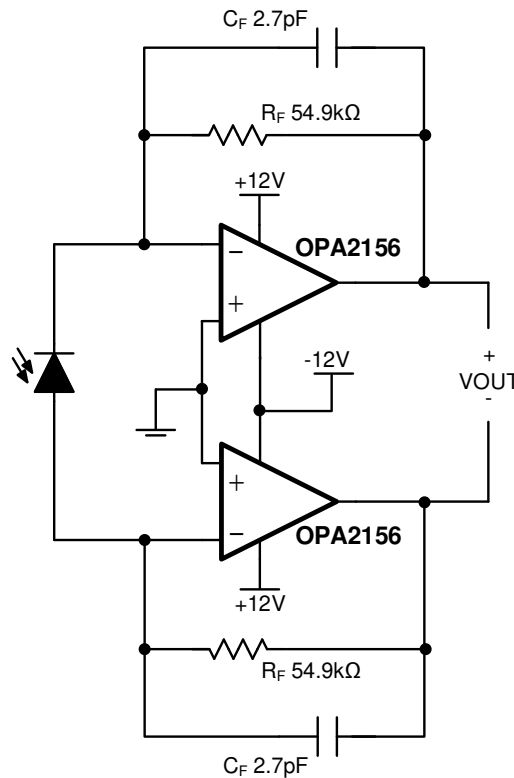
8.2.2 Detailed Design Procedure

In this example the OPA2156 serves as a transimpedance amplifier for a differential photodiode. The differential configuration allows for a wider output range (0 to 10-V differential) compared to a single-ended configuration (0 V to 5 V). This output can be connected to a differential successive approximation register (SAR) analog-to-digital converter (ADC). The basic equation for a differential transimpedance amplifier output voltage is shown in [公式 3](#).

$$V_{\text{OUT}} = I_{\text{PD}} \times 2 \times R_{\text{F}} \quad (3)$$

[公式 3](#) can be rearranged to calculate the value of the feedback resistors as shown in [公式 4](#).

Typical Application (接下页)

$$\frac{V_{OUT(MAX)} - V_{OUT(MIN)}}{2 \times I_{IN(MAX)}} \leq R_F$$

$$\frac{5V - (-5V)}{2 \times 90\mu A} \leq 55.6k\Omega$$

(4)

Adding a capacitor to the feedback loop creates a filter which will remove undesired noise beyond its cutoff frequency. For this application a 1-MHz cutoff frequency was selected. The equation for an RC filter is provided in [公式 5](#).

$$f_c = \frac{1}{2 \times \pi \times R_F \times C_F}$$

(5)

Rearranging this equation to solve for the capacitor value is show in [公式 6](#).

$$C_F \leq \frac{1}{2 \times \pi \times 54k\Omega \times 1MHz} \leq 2.7 pF$$

(6)

For more information on photodiode transimpedance amplifier system design and for a single-ended example, see [TIDU535: 1 MHz, Single-Supply, Photodiode Amplifier Reference Design](#).

8.2.3 Application Curves

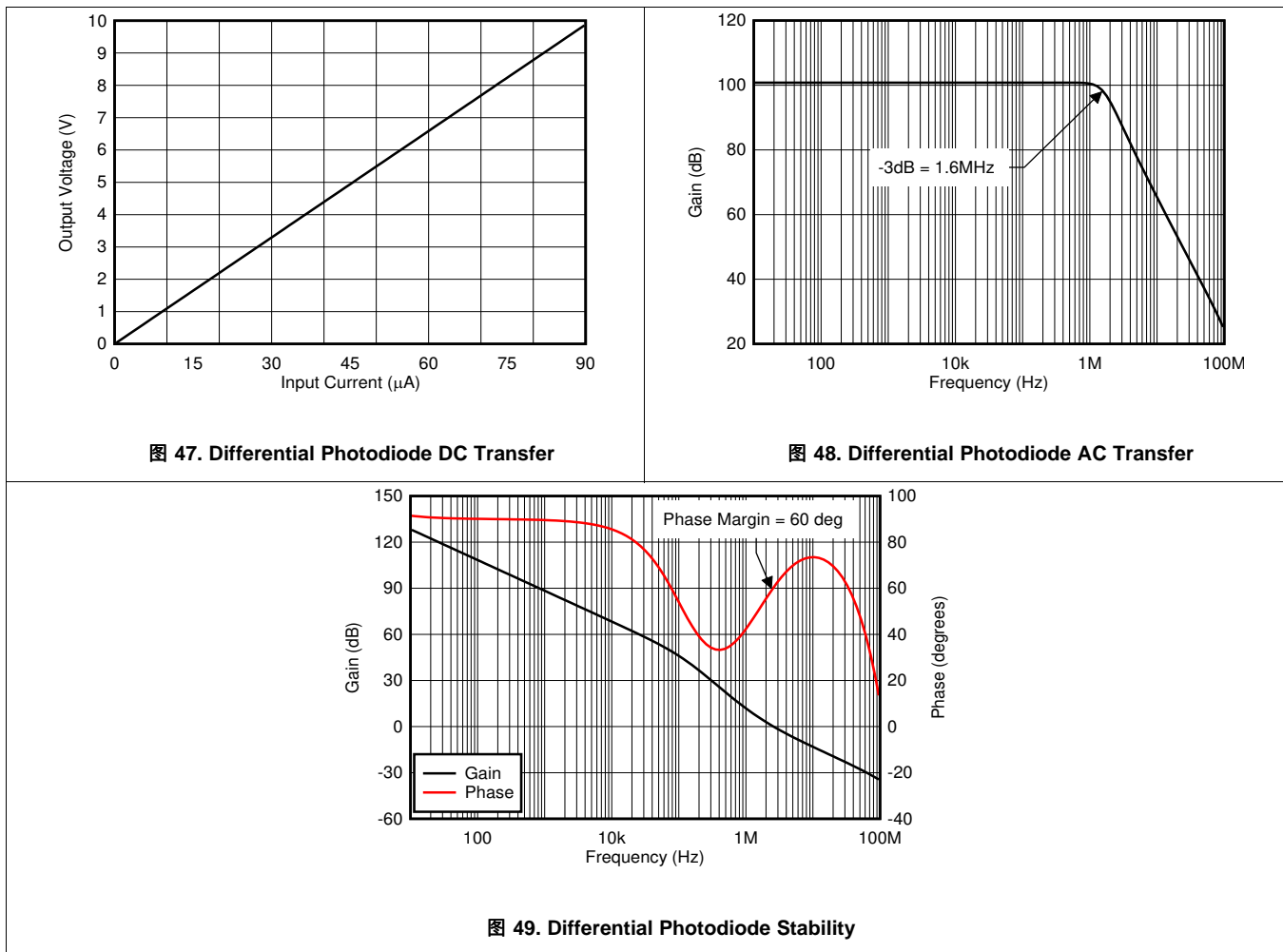

9 Power Supply Recommendations

The OPA2156 is specified for operation from 4.5 V to 36 V (± 2.25 V to ± 18 V); many specifications apply from -40°C to 125°C . Parameters that can exhibit significant variance with regard to operating voltage or temperature are presented in the [Typical Characteristics](#).

CAUTION

Supply voltages larger than 40 V can permanently damage the device; see the [Absolute Maximum Ratings](#).

10 Layout

10.1 Layout Guidelines

For best operational performance of the device, use good PCB layout practices, including:

- Connect low-ESR, 0.1- μF ceramic bypass capacitors between each supply pin and ground, placed as close as possible to the device. A single bypass capacitor from $V+$ to ground is applicable for single-supply applications.
 - Noise can propagate into analog circuitry through the power pins of the circuit as a whole and op amp itself. Bypass capacitors are used to reduce the coupled noise by providing low-impedance power sources local to the analog circuitry.
- Make sure to physically separate digital and analog grounds paying attention to the flow of the ground current. Separate grounding for analog and digital portions of circuitry is one of the simplest and most-effective methods of noise suppression. One or more layers on multilayer PCBs are usually devoted to ground planes. A ground plane helps distribute heat and reduces EMI noise pickup.
- In order to reduce parasitic coupling, run the input traces as far away as possible from the supply or output traces. If these traces cannot be kept separate, crossing the sensitive trace perpendicular is much better as opposed to in parallel with the noisy trace.
- Place the external components as close to the device as possible. As shown in [图 50](#), keeping RF and RG close to the inverting input minimizes parasitic capacitance.
- Keep the length of input traces as short as possible. Always remember that the input traces are the most sensitive part of the circuit.
- Consider a driven, low-impedance guard ring around the critical traces. A guard ring can significantly reduce leakage currents from nearby traces that are at different potentials.
- Clean the PCB following board assembly for best performance.
- Any precision integrated circuit may experience performance shifts due to moisture ingress into the plastic package. After any aqueous PCB cleaning process, bake the PCB assembly to remove moisture introduced into the device packaging during the cleaning process. A low-temperature, post-cleaning bake at 85°C for 30 minutes is sufficient for most circumstances.

10.1.1 Power Dissipation

The OPA2156 op amp is capable of driving a variety of loads with a power-supply voltage up to ± 18 V and full operating temperature range. Internal power dissipation increases when operating at high supply voltages and/or high output currents. Copper leadframe construction used in the OPA2156 improves heat dissipation compared to conventional materials. Circuit board layout can also help minimize junction temperature rise. Wide copper traces help dissipate the heat by acting as an additional heat sink. Temperature rise can be further minimized by soldering the devices to the circuit board rather than using a socket.

Layout Guidelines (接下页)

The OPA2156 has an internal thermal protection feature which prevents it from being damaged due to self heating, or the internal heating generated during normal operation. The protection circuitry works by monitoring the temperature of the output stage and turns off the output drive if the junction temperature of the device rises to approximately 170°C. The device has a thermal hysteresis of approximately 15°C, which allows the device to safely cool down before returning to normal operation at approximately 155°C. TI recommends that the system design takes into account the thermal dissipation of the OPA2156 to ensure that the recommended operating junction temperature of 125°C is not exceeded to avoid decreasing the lifespan of the device or permanently damaging the amplifier.

10.2 Layout Example

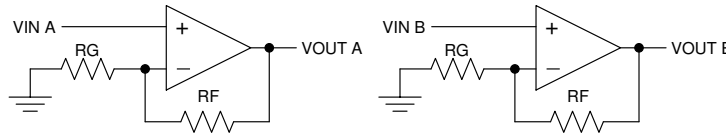

(Schematic Representation)



图 50. Operational Amplifier Board Layout for Noninverting Configuration

11 器件和文档支持

11.1 器件支持

11.1.1 开发支持

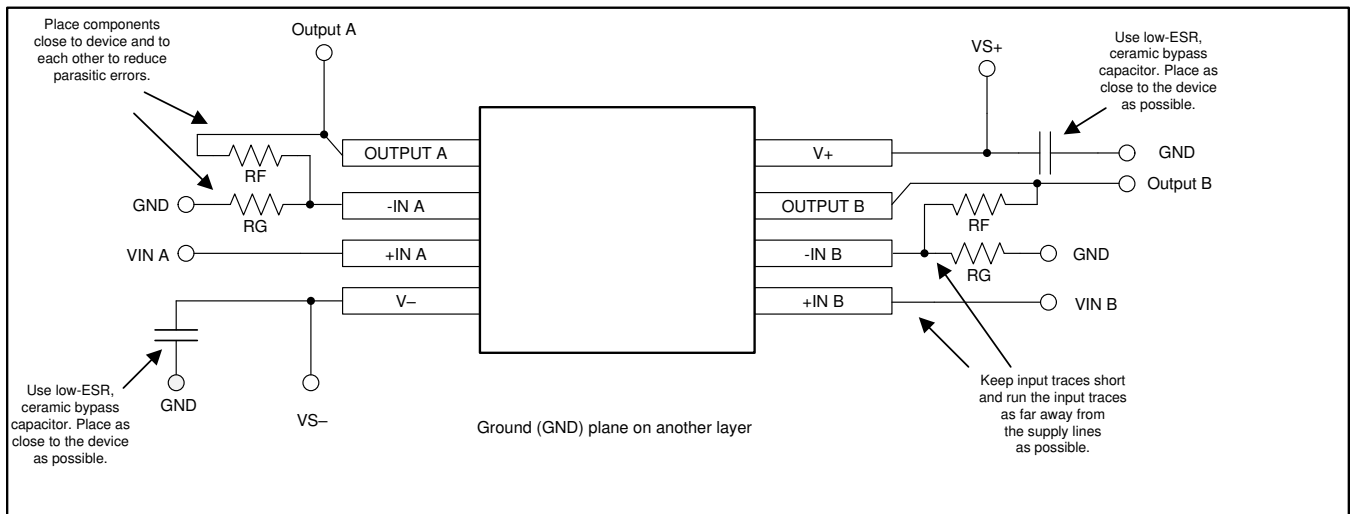
11.1.1.1 TINA-TI™ (免费下载)

TINA™是一款简单、功能强大且易于使用的电路仿真程序，此程序基于 SPICE 引擎。TINA-TI 是 TINA 软件的一款免费全功能版本，除了一系列无源和有源模型外，此版本软件还预先载入了一个宏模型库。TINA-TI 提供所有传统的 SPICE 直流、瞬态和频域分析，以及其他设计功能。

TINA-TI 可通过模拟电子实验室设计中心[免费下载](#)，该软件提供了丰富的后处理能力，允许用户以各种方式设置结果的格式。虚拟仪器提供选择输入波形和探测电路节点、电压以及波形的功能，从而构建一个动态的快速入门工具。

注

这些文件需要安装 TINA 软件（由 DesignSoft™提供）或者 TINA-TI 软件。请从 [TINA-TI](#) 文件夹中下载免费的 TINA-TI 软件（网址为 <http://www.ti.com.cn/tool/cn/tina-ti>）。

11.1.1.2 TI 高精度设计

TI 高精度设计（请访问 <http://www.ti.com.cn/ww/analog/precision-designs/> 获取）是由 TI 公司高精度模拟应用专家创建的模拟解决方案，提供了许多实用电路的工作原理、组件选择、仿真、完整印刷电路板 (PCB) 电路原理图和布局布线、物料清单以及性能测量结果。

11.2 文档支持

11.2.1 相关文档

- 德州仪器 (TI), [《运算放大器的 EMI 抑制比》应用报告](#)
- 德州仪器 (TI), [《0-1A 单电源低侧电流检测解决方案》参考设计](#)
- 德州仪器 (TI), [《适合所有人的运算放大器》设计参考](#)

11.3 接收文档更新通知

要接收文档更新通知，请导航至 TI.com.cn 上的器件产品文件夹。单击右上角的[通知我](#)进行注册，即可每周接收产品信息更改摘要。有关更改的详细信息，请查看任何已修订文档中包含的修订历史记录。

11.4 社区资源

The following links connect to TI community resources. Linked contents are provided "AS IS" by the respective contributors. They do not constitute TI specifications and do not necessarily reflect TI's views; see TI's [Terms of Use](#).

TI E2E™ Online Community *TI's Engineer-to-Engineer (E2E) Community*. Created to foster collaboration among engineers. At e2e.ti.com, you can ask questions, share knowledge, explore ideas and help solve problems with fellow engineers.

Design Support *TI's Design Support* Quickly find helpful E2E forums along with design support tools and contact information for technical support.

11.5 商标

E2E is a trademark of Texas Instruments.

TINA-TI is a trademark of Texas Instruments, Inc and DesignSoft, Inc.

TINA, DesignSoft are trademarks of DesignSoft, Inc.

All other trademarks are the property of their respective owners.

11.6 静电放电警告



ESD 可能会损坏该集成电路。德州仪器 (TI) 建议通过适当的预防措施处理所有集成电路。如果不遵守正确的处理措施和安装程序，可能会损坏集成电路。

ESD 的损坏小至导致微小的性能降级，大至整个器件故障。精密的集成电路可能更容易受到损坏，这是因为非常细微的参数更改都可能会导致器件与其发布的规格不相符。

11.7 Glossary

[SLYZ022](#) — *TI Glossary*.

This glossary lists and explains terms, acronyms, and definitions.

12 机械、封装和可订购信息

以下页面包含机械、封装和可订购信息。这些信息是指定器件的最新可用数据。数据如有变更，恕不另行通知，且不会对此文档进行修订。如需获取此数据表的浏览器版本，请查阅左侧的导航栏。

PACKAGING INFORMATION

Orderable Device	Status (1)	Package Type	Package Drawing	Pins	Package Qty	Eco Plan (2)	Lead finish/ Ball material (6)	MSL Peak Temp (3)	Op Temp (°C)	Device Marking (4/5)	Samples
OPA2156ID	ACTIVE	SOIC	D	8	75	RoHS & Green	NIPDAU	Level-2-260C-1 YEAR	-40 to 125	OP2156	Samples
OPA2156IDGKR	ACTIVE	VSSOP	DGK	8	2500	RoHS & Green	NIPDAUAG SN	Level-2-260C-1 YEAR	-40 to 125	1THV	Samples
OPA2156IDGKT	ACTIVE	VSSOP	DGK	8	250	RoHS & Green	NIPDAUAG SN	Level-2-260C-1 YEAR	-40 to 125	1THV	Samples
OPA2156IDR	ACTIVE	SOIC	D	8	2500	RoHS & Green	NIPDAU	Level-2-260C-1 YEAR	-40 to 125	OP2156	Samples

(1) The marketing status values are defined as follows:

ACTIVE: Product device recommended for new designs.

LIFEBUY: TI has announced that the device will be discontinued, and a lifetime-buy period is in effect.

NRND: Not recommended for new designs. Device is in production to support existing customers, but TI does not recommend using this part in a new design.

PREVIEW: Device has been announced but is not in production. Samples may or may not be available.

OBSELETE: TI has discontinued the production of the device.

(2) **RoHS:** TI defines "RoHS" to mean semiconductor products that are compliant with the current EU RoHS requirements for all 10 RoHS substances, including the requirement that RoHS substance do not exceed 0.1% by weight in homogeneous materials. Where designed to be soldered at high temperatures, "RoHS" products are suitable for use in specified lead-free processes. TI may reference these types of products as "Pb-Free".

RoHS Exempt: TI defines "RoHS Exempt" to mean products that contain lead but are compliant with EU RoHS pursuant to a specific EU RoHS exemption.

Green: TI defines "Green" to mean the content of Chlorine (Cl) and Bromine (Br) based flame retardants meet JS709B low halogen requirements of <=1000ppm threshold. Antimony trioxide based flame retardants must also meet the <=1000ppm threshold requirement.

(3) MSL, Peak Temp. - The Moisture Sensitivity Level rating according to the JEDEC industry standard classifications, and peak solder temperature.

(4) There may be additional marking, which relates to the logo, the lot trace code information, or the environmental category on the device.

(5) Multiple Device Markings will be inside parentheses. Only one Device Marking contained in parentheses and separated by a "-" will appear on a device. If a line is indented then it is a continuation of the previous line and the two combined represent the entire Device Marking for that device.

(6) Lead finish/Ball material - Orderable Devices may have multiple material finish options. Finish options are separated by a vertical ruled line. Lead finish/Ball material values may wrap to two lines if the finish value exceeds the maximum column width.

Important Information and Disclaimer:The information provided on this page represents TI's knowledge and belief as of the date that it is provided. TI bases its knowledge and belief on information provided by third parties, and makes no representation or warranty as to the accuracy of such information. Efforts are underway to better integrate information from third parties. TI has taken and

continues to take reasonable steps to provide representative and accurate information but may not have conducted destructive testing or chemical analysis on incoming materials and chemicals. TI and TI suppliers consider certain information to be proprietary, and thus CAS numbers and other limited information may not be available for release.

In no event shall TI's liability arising out of such information exceed the total purchase price of the TI part(s) at issue in this document sold by TI to Customer on an annual basis.

TAPE AND REEL INFORMATION

QUADRANT ASSIGNMENTS FOR PIN 1 ORIENTATION IN TAPE

*All dimensions are nominal

Device	Package Type	Package Drawing	Pins	SPQ	Reel Diameter (mm)	Reel Width W1 (mm)	A0 (mm)	B0 (mm)	K0 (mm)	P1 (mm)	W (mm)	Pin1 Quadrant
OPA2156IDGKR	VSSOP	DGK	8	2500	330.0	12.4	5.3	3.4	1.4	8.0	12.0	Q1
OPA2156IDGKT	VSSOP	DGK	8	250	330.0	12.4	5.3	3.4	1.4	8.0	12.0	Q1
OPA2156IDR	SOIC	D	8	2500	330.0	12.4	6.4	5.2	2.1	8.0	12.0	Q1

TAPE AND REEL BOX DIMENSIONS

*All dimensions are nominal

Device	Package Type	Package Drawing	Pins	SPQ	Length (mm)	Width (mm)	Height (mm)
OPA2156IDGKR	VSSOP	DGK	8	2500	366.0	364.0	50.0
OPA2156IDGKT	VSSOP	DGK	8	250	366.0	364.0	50.0
OPA2156IDR	SOIC	D	8	2500	356.0	356.0	35.0

TUBE

*All dimensions are nominal

Device	Package Name	Package Type	Pins	SPQ	L (mm)	W (mm)	T (μm)	B (mm)
OPA2156ID	D	SOIC	8	75	506.6	8	3940	4.32



D0008A

PACKAGE OUTLINE

SOIC - 1.75 mm max height

SMALL OUTLINE INTEGRATED CIRCUIT



4214825/C 02/2019

NOTES:

1. Linear dimensions are in inches [millimeters]. Dimensions in parenthesis are for reference only. Controlling dimensions are in inches. Dimensioning and tolerancing per ASME Y14.5M.
2. This drawing is subject to change without notice.
3. This dimension does not include mold flash, protrusions, or gate burrs. Mold flash, protrusions, or gate burrs shall not exceed $.006$ [0.15] per side.
4. This dimension does not include interlead flash.
5. Reference JEDEC registration MS-012, variation AA.

EXAMPLE BOARD LAYOUT

D0008A

SOIC - 1.75 mm max height

SMALL OUTLINE INTEGRATED CIRCUIT



LAND PATTERN EXAMPLE
 EXPOSED METAL SHOWN
 SCALE:8X



SOLDER MASK DETAILS

4214825/C 02/2019

NOTES: (continued)

- 6. Publication IPC-7351 may have alternate designs.
- 7. Solder mask tolerances between and around signal pads can vary based on board fabrication site.

EXAMPLE STENCIL DESIGN

D0008A

SOIC - 1.75 mm max height

SMALL OUTLINE INTEGRATED CIRCUIT



SOLDER PASTE EXAMPLE
BASED ON .005 INCH [0.125 MM] THICK STENCIL
SCALE:8X

4214825/C 02/2019

NOTES: (continued)

8. Laser cutting apertures with trapezoidal walls and rounded corners may offer better paste release. IPC-7525 may have alternate design recommendations.
9. Board assembly site may have different recommendations for stencil design.

DGK (S-PDSO-G8)

PLASTIC SMALL-OUTLINE PACKAGE



- NOTES:
- A. All linear dimensions are in millimeters.
 - B. This drawing is subject to change without notice.
 - \angle C Body length does not include mold flash, protrusions, or gate burrs. Mold flash, protrusions, or gate burrs shall not exceed 0.15 per end.
 - \angle D Body width does not include interlead flash. Interlead flash shall not exceed 0.50 per side.
 - E. Falls within JEDEC MO-187 variation AA, except interlead flash.



- NOTES:
- A. All linear dimensions are in millimeters.
 - B. This drawing is subject to change without notice.
 - C. Publication IPC-7351 is recommended for alternate designs.
 - D. Laser cutting apertures with trapezoidal walls and also rounding corners will offer better paste release. Customers should contact their board assembly site for stencil design recommendations. Refer to IPC-7525 for other stencil recommendations.
 - E. Customers should contact their board fabrication site for solder mask tolerances between and around signal pads.

重要声明和免责声明

TI“按原样”提供技术和可靠性数据（包括数据表）、设计资源（包括参考设计）、应用或其他设计建议、网络工具、安全信息和其他资源，不保证没有瑕疵且不做任何明示或暗示的担保，包括但不限于对适销性、某特定用途方面的适用性或不侵犯任何第三方知识产权的暗示担保。

这些资源可供使用 TI 产品进行设计的熟练开发人员使用。您将自行承担以下全部责任：(1) 针对您的应用选择合适的 TI 产品，(2) 设计、验证并测试您的应用，(3) 确保您的应用满足相应标准以及任何其他功能安全、信息安全、监管或其他要求。

这些资源如有变更，恕不另行通知。TI 授权您仅可将这些资源用于研发本资源所述的 TI 产品的应用。严禁对这些资源进行其他复制或展示。您无权使用任何其他 TI 知识产权或任何第三方知识产权。您应全额赔偿因在这些资源的使用中对 TI 及其代表造成的任何索赔、损害、成本、损失和债务，TI 对此概不负责。

TI 提供的产品受 [TI 的销售条款](#) 或 [ti.com](#) 上其他适用条款/TI 产品随附的其他适用条款的约束。TI 提供这些资源并不会扩展或以其他方式更改 TI 针对 TI 产品发布的适用的担保或担保免责声明。

TI 反对并拒绝您可能提出的任何其他或不同的条款。

邮寄地址：Texas Instruments, Post Office Box 655303, Dallas, Texas 75265

Copyright © 2023，德州仪器 (TI) 公司

单击下面可查看定价，库存，交付和生命周期等信息

[>>TI\(德州仪器\)](#)