

## TLV701x and TLV702x Small-Size, Low-Power, Low-Voltage Comparators

### 1 Features

- Ultra-small packages: X2SON (0.8 × 0.8 mm<sup>2</sup>), WSON (2 × 2 mm<sup>2</sup>)
- Standard packages: SOT23, SC70, VSSOP
- Wide supply voltage range of 1.6 V to 6.5 V
- Quiescent supply current of 5  $\mu$ A
- Low propagation delay of 260 ns
- Rail-to-rail common-mode input voltage
- Internal hysteresis
- Push-pull and open-drain output options
- No phase reversal for over driven inputs
- –40°C to 125°C Operating ambient temperature

### 2 Applications

- Mobile phones and tablets
- Portable and battery-powered devices
- IR receivers
- Level translators
- Threshold detectors and discriminators
- Window comparators
- Zero-crossing detectors

### 3 Description

The TLV7011/7021 (single-channel) and TLV7012/7022 (dual-channel) are micro-power comparators that feature low-voltage operation with rail-to-rail input capability. These comparators are available in an ultra-small, leadless package measuring 0.8 mm × 0.8 mm and standard leaded packages, making them applicable for space-critical designs like smartphones and other portable or battery-powered applications.

The TLV701x and TLV702x offer an excellent speed-to-power combination with a propagation delay of 260 ns and a quiescent supply current of 5  $\mu$ A. This combination of fast response time at micropower enables power conscious systems to monitor and respond quickly to fault conditions. With an operating voltage range of 1.6 V to 6.5 V, these comparators are compatible with 3-V and 5-V systems.

These comparators also feature no output phase inversion with overdriven inputs and internal hysteresis. These features make this family of comparators well suited for precision voltage monitoring in harsh, noisy environments where slow-moving input signals must be converted into clean digital outputs.

The TLV701x have push-pull output stages capable of sinking and sourcing milliamps of current when controlling an LED or driving a capacitive load. The TLV702x have open-drain output stages that can be pulled beyond  $V_{CC}$ , making it appropriate for level translators and bipolar to single-ended converters.

#### Device Information<sup>(1)</sup>

| PART NUMBERS        | PACKAGE (PINS) | BODY SIZE (NOM)   |
|---------------------|----------------|-------------------|
| TLV7011,<br>TLV7021 | X2SON (5)      | 0.80 mm × 0.80 mm |
|                     | SC70 (5)       | 2.00 mm × 1.25 mm |
|                     | SOT-23 (5)     | 2.90 mm × 1.60 mm |
| TLV7012,<br>TLV7022 | VSSOP (8)      | 3 mm × 3 mm       |
|                     | SOT-23 (8)     | 2.90 mm × 1.60 mm |
|                     | WSON (8)       | 2 mm × 2 mm       |

(1) For all available packages, see the orderable addendum at the end of the data sheet.

#### TLV70x1 Family of Low Power Comparators

| PART NUMBERS | OUTPUT                 | $I_Q$     | $t_{PD}$  |
|--------------|------------------------|-----------|-----------|
| TLV701x / 2x | Push-pull / Open-drain | 5 $\mu$ A | 260 ns    |
| TLV703x / 4x | Push-pull / Open-drain | 335 nA    | 3 $\mu$ s |

#### X2SON Package vs SC70 and US Dime

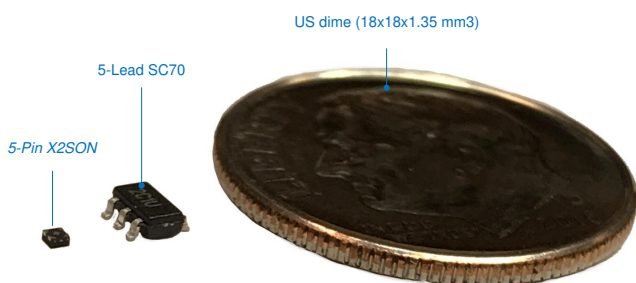

#### Propagation Delay vs. Overdrive

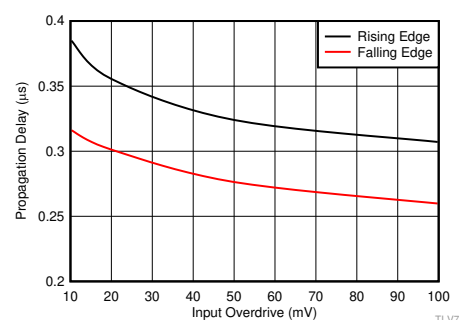

$T_A = 25^\circ\text{C}$ ,  $V_{CC} = 5\text{ V}$ ,  $C_L = 15\text{ pF}$



## Table of Contents

|          |   |           |           |   |           |
|----------|---|-----------|-----------|---|-----------|
| <b>1</b> | <b>Features</b> .....                           | <b>1</b>  | 7.1       | Overview .....  | <b>15</b> |
| <b>2</b> | <b>Applications</b> .....                       | <b>1</b>  | 7.2       | Functional Block Diagram .....                                | <b>15</b> |
| <b>3</b> | <b>Description</b> .....                        | <b>1</b>  | 7.3       | Feature Description .....                                     | <b>15</b> |
| <b>4</b> | <b>Revision History</b> .....                   | <b>2</b>  | 7.4       | Device Functional Modes .....                                 | <b>15</b> |
| <b>5</b> | <b>Pin Configuration and Functions</b> .....    | <b>3</b>  | <b>8</b>  | <b>Application and Implementation</b> .....                   | <b>17</b> |
| <b>6</b> | <b>Specifications</b> .....                     | <b>5</b>  | 8.1       | Application Information .....                                 | <b>17</b> |
| 6.1      | Absolute Maximum Ratings (Single) .....         | <b>5</b>  | 8.2       | Typical Applications .....                                    | <b>19</b> |
| 6.2      | Absolute Maximum Ratings (Dual) .....           | <b>5</b>  | <b>9</b>  | <b>Power Supply Recommendations</b> .....                     | <b>24</b> |
| 6.3      | ESD Ratings .....                               | <b>5</b>  | <b>10</b> | <b>Layout</b> .....   | <b>24</b> |
| 6.4      | Recommended Operating Conditions (Single) ..... | <b>5</b>  | 10.1      | Layout Guidelines .....                                       | <b>24</b> |
| 6.5      | Recommended Operating Conditions (Dual) .....   | <b>6</b>  | 10.2      | Layout Example .....  | <b>24</b> |
| 6.6      | Thermal Information (Single) .....              | <b>6</b>  | <b>11</b> | <b>Device and Documentation Support</b> .....                 | <b>25</b> |
| 6.7      | Thermal Information (Dual) .....                | <b>6</b>  | 11.1      | Device Support .....  | <b>25</b> |
| 6.8      | Electrical Characteristics (Single) .....       | <b>7</b>  | 11.2      | Related Links .....   | <b>25</b> |
| 6.9      | Switching Characteristics (Single) .....        | <b>7</b>  | 11.3      | Receiving Notification of Documentation Updates .....         | <b>25</b> |
| 6.10     | Electrical Characteristics (Dual) .....         | <b>8</b>  | 11.4      | Community Resources .....                                     | <b>25</b> |
| 6.11     | Switching Characteristics (Dual) .....          | <b>8</b>  | 11.5      | Trademarks .....  | <b>25</b> |
| 6.12     | Timing Diagrams .....                           | <b>8</b>  | 11.6      | Electrostatic Discharge Caution .....                         | <b>25</b> |
| 6.13     | Typical Characteristics .....                   | <b>10</b> | 11.7      | Glossary .....  | <b>25</b> |
| <b>7</b> | <b>Detailed Description</b> .....               | <b>15</b> | <b>12</b> | <b>Mechanical, Packaging, and Orderable Information</b> ..... | <b>25</b> |

## 4 Revision History

| <b>Changes from Revision E (October 2019) to Revision F</b>                                       | <b>Page</b> |
|---|-------------|
| • Added SOT-23 (8) and WSON (8) for dual channel options .....                                    | <b>1</b>    |
| • Added SOT-23 (8) and WSON (8) Pin Functions and Package drawings for dual channel options ..... | <b>4</b>    |
| • Added SOT-23 (8) and WSON (8) Thermal Tables for dual channel options .....                     | <b>5</b>    |

| <b>Changes from Revision D (February 2019) to Revision E</b> | <b>Page</b> |
|--|-------------|
| • Added dual channel options .....                           | <b>1</b>    |

| <b>Changes from Revision C (March 2018) to Revision D</b> | <b>Page</b> |
|---|-------------|
| • Added leaded package option to features .....           | <b>1</b>    |
| • Deleted preview status of SOT23 package .....           | <b>1</b>    |
| • Deleted preview status of SOT23 package .....           | <b>3</b>    |

| <b>Changes from Revision B (November 2017) to Revision C</b> | <b>Page</b> |
|--|-------------|
| • Changed the preview SC70 package to production data .....  | <b>1</b>    |

  

| <b>Changes from Revision A (July 2017) to Revision B</b>  | <b>Page</b> |
|---|-------------|
| • Changed propagation delay from: 200 ns to: 260 ns .....   | <b>1</b>    |
| • Added preview SC70 and SOT-23 packages to the data sheet .....  | <b>1</b>    |
| • Added <i>TLV70x1 Family of Micropower Comparators</i> table per marketing request .....   | <b>1</b>    |
| • Changed the key graphic title from: <i>Propagation Delay vs. Overdrive (TLV7011)</i> to: <i>Propagation Delay vs. Overdrive</i> ..... | <b>1</b>    |
| • Removed (TLV7011 only) text from several <i>Typical Characteristics</i> graphs .....  | <b>10</b>   |

- Added [Figure 7](#) ..... 10
- Added [Figure 10](#) ..... 10
- Removed some *Typical Characteristics* graphs ..... 13
- Added content to the *Inputs* section ..... 15
- Added the *IR Receiver Analog Front End* section ..... 20

| Changes from Original (May 2017) to Revision A                      | Page |
|---|------|
| • Changed device status from ADVANCED INFO to PRODUCTION DATA ..... | 1    |

## 5 Pin Configuration and Functions

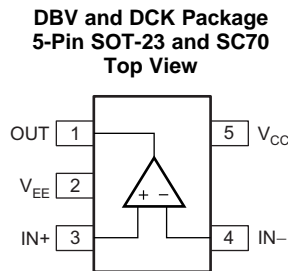
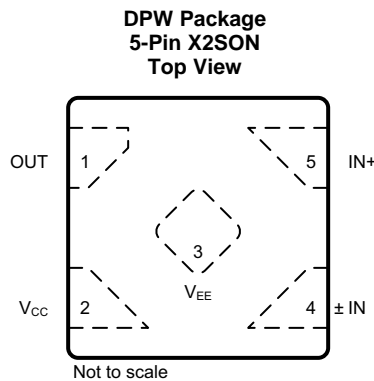

### Pin Functions

| NAME            | PIN   |              | I/O/P <sup>(1)</sup> | DESCRIPTION                     |
|-----------------|-------|--------------|----------------------|---------------------------------|
|                 | X2SON | SOT-23, SC70 |                      |                                 |
| OUT             | 1     | 1            | O                    | Output                          |
| V <sub>CC</sub> | 2     | 5            | P                    | Positive (highest) power supply |
| V <sub>EE</sub> | 3     | 2            | P                    | Negative (lowest) power supply  |
| IN-             | 4     | 4            | I                    | Inverting input                 |
| IN+             | 5     | 3            | I                    | Noninverting input              |

(1) I = Input, O = Output, P = Power

**TLV7012/22 DGK, DDF Packages  
8-Pin VSSOP, SOT-23  
Top View**

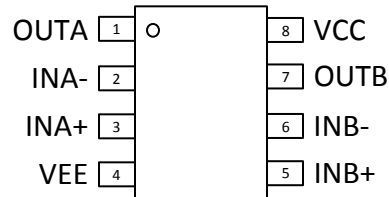

**TLV7012/22 DSG Package  
8-Pin WSON With Exposed Thermal Pad  
Top View**

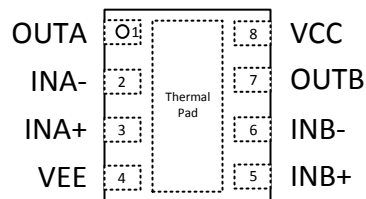

(1) Connect thermal pad to V-.

**Pin Functions: TLV7012/22**

| PIN  |     | I/O | DESCRIPTION  |
|------|-----|-----|--|
| NAME | NO. |     |  |
| INA- | 2   | I   | Inverting input, channel A                                       |
| INA+ | 3   | I   | Noninverting input, channel A                                    |
| INB- | 6   | I   | Inverting input, channel B                                       |
| INB+ | 5   | I   | Noninverting input, channel B                                    |
| OUTA | 1   | O   | Output, channel A  |
| OUTB | 7   | O   | Output, channel B  |
| VEE  | 4   | —   | Negative (lowest) supply or ground (for single-supply operation) |
| VCC  | 8   | —   | Positive (highest) supply  |

## 6 Specifications

### 6.1 Absolute Maximum Ratings (Single)

over operating free-air temperature range (unless otherwise noted)<sup>(1)</sup>

|   |                             | MIN            | MAX            | UNIT |
|---|-----------------------------|----------------|----------------|------|
| Supply voltage ( $V_S = V_{CC} - V_{EE}$ )        |                             |                | 6              | V    |
| Input pins (IN+, IN-) <sup>(2)</sup>              |                             | $V_{EE} - 0.3$ | 6              | V    |
| Current into Input pins (IN+, IN-) <sup>(2)</sup> |                             |                | ±10            | mA   |
| Output (OUT)                                      | TLV7011/7012 <sup>(3)</sup> | $V_{EE} - 0.3$ | $V_{CC} + 0.3$ | V    |
|   | TLV7021/7022                | $V_{EE} - 0.3$ | 6              |      |
| Output short-circuit duration <sup>(4)</sup>      |                             |                | 10             | s    |
| Junction temperature, $T_J$                       |                             |                | 150            | °C   |
| Storage temperature, $T_{stg}$                    |                             | -65            | 150            | °C   |

- (1) Stresses beyond those listed under *Absolute Maximum Ratings* may cause permanent damage to the device. These are stress ratings only, which do not imply functional operation of the device at these or any other conditions beyond those indicated under *Recommended Operating Conditions*. Exposure to absolute-maximum-rated conditions for extended periods may affect device reliability.
- (2) Input terminals are diode-clamped to  $V_{EE}$ . Input signals that can swing 0.3V below  $V_{EE}$  must be current-limited to 10mA or less.
- (3) Output maximum is ( $V_{CC} + 0.3V$ ) or 6V, whichever is less.
- (4) Short-circuit to ground, one comparator per package.

### 6.2 Absolute Maximum Ratings (Dual)

over operating free-air temperature range (unless otherwise noted)<sup>(1)</sup>

|  |  | MIN            | MAX            | UNIT |
|--|--|----------------|----------------|------|
| Supply voltage $V_S = V_{CC} - V_{EE}$       |  | -0.3           | 7              | V    |
| Input pins (IN+, IN-) <sup>(2)</sup>         |  | $V_{EE} - 0.3$ | 7              | V    |
| Current into Input pins (IN+, IN-)           |  |                | ±10            | mA   |
| Output (OUT) (TLV7012) <sup>(3)</sup>        |  | $V_{EE} - 0.3$ | $V_{CC} + 0.3$ | V    |
| Output (OUT) (TLV7022)                       |  | $V_{EE} - 0.3$ | 7              | V    |
| Output short-circuit duration <sup>(4)</sup> |  |                | 10             | s    |
| Junction temperature, $T_J$                  |  |                | 150            | °C   |
| Storage temperature, $T_{stg}$               |  | -65            | 150            | °C   |

- (1) Stresses beyond those listed under *Absolute Maximum Ratings* may cause permanent damage to the device. These are stress ratings only, which do not imply functional operation of the device at these or any other conditions beyond those indicated under *Recommended Operating Conditions*. Exposure to absolute-maximum-rated conditions for extended periods may affect device reliability.
- (2) Input terminals are diode-clamped to  $V_{EE}$ . Input signals that can swing 0.3V below  $V_{EE}$  must be current-limited to 10mA or less.
- (3) Output maximum is ( $V_{CC} + 0.3V$ ) or 7V, whichever is less.
- (4) Short-circuit to ground, one comparator per package.

### 6.3 ESD Ratings

|             |                         | VALUE  | UNIT  |
|-------------|-------------------------|--|-------|
| $V_{(ESD)}$ | Electrostatic discharge | Human-body model (HBM), per ANSI/ESDA/JEDEC JS-001 <sup>(1)</sup>              | ±2000 |
|             |                         | Charged-device model (CDM), per JEDEC specification JESD22-C101 <sup>(2)</sup> | ±1000 |

- (1) JEDEC document JEP155 states that 500-V HBM allows safe manufacturing with a standard ESD control process.
- (2) JEDEC document JEP157 states that 250-V CDM allows safe manufacturing with a standard ESD control process.

### 6.4 Recommended Operating Conditions (Single)

over operating free-air temperature range (unless otherwise noted)

|  |  | MIN            | NOM | MAX            | UNIT |
|--|--|----------------|-----|----------------|------|
| Supply voltage ( $V_S = V_{CC} - V_{EE}$ ) |  | 1.6            |     | 5.5            | V    |
| Input Voltage Range                        |  | $V_{EE} - 0.1$ |     | $V_{CC} + 0.2$ | V    |
| Ambient temperature, $T_A$                 |  | -40            |     | 125            | °C   |

## 6.5 Recommended Operating Conditions (Dual)

over operating free-air temperature range (unless otherwise noted)

|  | MIN            | MAX            | UNIT |
|--|----------------|----------------|------|
| Supply voltage $V_S = V_{CC} - V_{EE}$ | 1.6            | 6.5            | V    |
| Input voltage range                    | $V_{CC} - 0.1$ | $V_{EE} + 0.2$ | V    |
| Ambient temperature, $T_A$             | -40            | 125            | °C   |

## 6.6 Thermal Information (Single)

| THERMAL METRIC <sup>(1)</sup> |  | TLV7011/TLV7021 |             |            | UNIT |
|-------------------------------|--|-----------------|-------------|------------|------|
|                               |  | DPW (X2SON)     | DBV (SOT23) | DCK (SC70) |      |
|                               |  | 5 PINS          | 5 PINS      | 5 PINS     |      |
| $R_{\theta JA}$               | Junction-to-ambient thermal resistance       | 497.5           | 306.3       | 278.8      | °C/W |
| $R_{\theta JC(top)}$          | Junction-to-case (top) thermal resistance    | 275.5           | 228.4       | 188.6      | °C/W |
| $R_{\theta JB}$               | Junction-to-board thermal resistance         | 372.2           | 166.5       | 113.2      | °C/W |
| $\Psi_{JT}$                   | Junction-to-top characterization parameter   | 55.5            | 138.5       | 82.3       | °C/W |
| $\Psi_{JB}$                   | Junction-to-board characterization parameter | 370.3           | 165.3       | 112.4      | °C/W |
| $R_{\theta JC(bot)}$          | Junction-to-case (bottom) thermal resistance | 165.1           | N/A         | N/A        | °C/W |

(1) For more information about traditional and new thermal metrics, see the [Semiconductor and IC Package Thermal Metrics](#) application report.

## 6.7 Thermal Information (Dual)

| THERMAL METRIC <sup>(1)</sup> |  | TLV7012/TLV7022 |              |            | UNIT |
|-------------------------------|--|-----------------|--------------|------------|------|
|                               |  | DGK (VSSOP)     | DDF (SOT-23) | DSG (WSON) |      |
|                               |  | 8 PINS          | 8 PINS       | 8 PINS     |      |
| $R_{\theta JA}$               | Junction-to-ambient thermal resistance       | 211.7           | 212.5        | 106.1      | °C/W |
| $R_{\theta JC(top)}$          | Junction-to-case (top) thermal resistance    | 96.1            | 127.3        | 127.3      | °C/W |
| $R_{\theta JB}$               | Junction-to-board thermal resistance         | 133.5           | 129.2        | 72.5       | °C/W |
| $\Psi_{JT}$                   | Junction-to-top characterization parameter   | 28.3            | 25.8         | 16.8       | °C/W |
| $\Psi_{JB}$                   | Junction-to-board characterization parameter | 131.7           | 129.0        | 72.2       | °C/W |
| $R_{\theta JC(bot)}$          | Junction-to-case (bottom) thermal resistance | N/A             | N/A          | 47.6       | °C/W |

(1) For more information about traditional and new thermal metrics, see the [Semiconductor and IC Package Thermal Metrics](#) application report.

## 6.8 Electrical Characteristics (Single)

$V_S = 1.8\text{ V to }5\text{ V}$ ,  $V_{CM} = V_S / 2$ ; minimum and maximum values are at  $T_A = -40^\circ\text{C to }+125^\circ\text{C}$  (unless otherwise noted). Typical values are at  $T_A = 25^\circ\text{C}$ .

| PARAMETER |  | TEST CONDITIONS  | MIN            | TYP       | MAX            | UNIT          |
|-----------|--|--|----------------|-----------|----------------|---------------|
| $V_{IO}$  | Input offset voltage                             | $V_S = 1.8\text{ V and }5\text{ V}$ , $V_{CM} = V_S / 2$                           |                | $\pm 0.5$ | $\pm 8$        | mV            |
| $V_{HYS}$ | Hysteresis                                       | $V_S = 1.8\text{ V and }5\text{ V}$ , $V_{CM} = V_S / 2$                           | 1.2            | 4.2       | 14             | mV            |
| $V_{CM}$  | Common-mode voltage range                        | $V_S = 2.5\text{ V to }5\text{ V}$   |                | $V_{EE}$  | $V_{CC} + 0.1$ | V             |
|           |  | $V_S = 1.8\text{ V to }2.5\text{ V}$   | $V_{EE} + 0.1$ |           | $V_{CC} + 0.1$ |               |
| $I_B$     | Input bias current                               |  |                | 5         |                | pA            |
| $I_{OS}$  | Input offset current                             |  |                | 1         |                | pA            |
| $V_{OH}$  | Output voltage high (for TLV7011 only)           | $V_S = 5\text{ V}$ , $I_O = 3\text{ mA}$   | 4.7            | 4.8       |                | V             |
| $V_{OL}$  | Output voltage low                               | $V_S = 5\text{ V}$ , $I_O = 3\text{ mA}$   |                | 120       | 220            | mV            |
| $I_{LKG}$ | Open-drain output leakage current (TLV7021 only) | $V_S = 5\text{ V}$ , $V_{ID} = +0.1\text{ V}$ (output high), $V_{PULLUP} = V_{CC}$ |                | 100       |                | pA            |
| CMRR      | Common-mode rejection ratio                      | $V_{EE} < V_{CM} < V_{CC}$ , $V_S = 5\text{ V}$                                    |                | 78        |                | dB            |
| PSRR      | Power supply rejection ratio                     | $V_S = 1.8\text{ V to }5\text{ V}$ , $V_{CM} = V_S / 2$                            |                | 78        |                | dB            |
| $I_{SC}$  | Short-circuit current                            | $V_S = 5\text{ V}$ , sourcing  |                | 65        |                | mA            |
|           |  | $V_S = 5\text{ V}$ , sinking   |                | 44        |                |               |
| $I_{CC}$  | Supply current                                   | $V_S = 1.8\text{ V}$ , no load, $V_{ID} = -0.1\text{ V}$ (Output Low)              |                | 5         | 10             | $\mu\text{A}$ |

## 6.9 Switching Characteristics (Single)

Typical values are at  $T_A = 25^\circ\text{C}$ ,  $V_{CC} = 5\text{ V}$ ,  $V_{CM} = 2.5\text{ V}$ ;  $C_L = 15\text{ pF}$ , input overdrive = 100 mV (unless otherwise noted).

| PARAMETER |  | TEST CONDITIONS   | MIN | TYP | MAX | UNIT          |
|-----------|--|---|-----|-----|-----|---------------|
| $t_{PHL}$ | Propagation delay time, high-to-low ( $R_P = 2.5\text{ k}\Omega$ TLV7021 only) | Midpoint of input to midpoint of output, $V_{OD} = 100\text{ mV}$ |     | 260 |     | ns            |
| $t_{PLH}$ | Propagation delay time, low-to-high ( $R_P = 2.5\text{ k}\Omega$ TLV7021 only) | Midpoint of input to midpoint of output, $V_{OD} = 100\text{ mV}$ |     | 310 |     | ns            |
| $t_R$     | Rise time (for TLV7011 only)   | 20% to 80%  |     | 5   |     | ns            |
| $t_F$     | Fall time  | 80% to 20%  |     | 5   |     | ns            |
| $t_{ON}$  | Power-up time <sup>(1)</sup>   |   |     | 20  |     | $\mu\text{s}$ |

(1) During power on,  $V_S$  must exceed 1.6 V for  $t_{ON}$  before the output tracks the input.

## 6.10 Electrical Characteristics (Dual)

$V_S = 1.8\text{ V to }5\text{ V}$ ,  $V_{CM} = V_S / 2$ ; minimum and maximum values are at  $T_A = -40^\circ\text{C to }+125^\circ\text{C}$  (unless otherwise noted).

Typical values are at  $T_A = 25^\circ\text{C}$ .

| PARAMETER |  | TEST CONDITIONS  | MIN      | TYP       | MAX            | UNIT          |
|-----------|--|--|----------|-----------|----------------|---------------|
| $V_{IO}$  | Input Offset Voltage                             | $V_S = 1.8\text{ V and }5\text{ V}$ , $V_{CM} = V_S / 2$                           |          | $\pm 0.1$ | $\pm 8$        | mV            |
| $V_{HYS}$ | Hysteresis                                       | $V_S = 1.8\text{ V and }5\text{ V}$ , $V_{CM} = V_S / 2$                           | 2        | 7.2       | 15             | mV            |
| $V_{CM}$  | Common-mode voltage range                        |  | $V_{EE}$ |           | $V_{CC} + 0.1$ | V             |
| $I_B$     | Input bias current                               |  |          | 2         |                | pA            |
| $I_{OS}$  | Input offset current                             |  |          | 1         |                | pA            |
| $V_{OH}$  | Output voltage high (for TLV7012 only)           | $V_S = 5\text{ V}$ , $V_{EE} = 0\text{ V}$ , $I_O = 3\text{ mA}$                   | 4.65     | 4.8       |                | V             |
| $V_{OL}$  | Output voltage low                               | $V_S = 5\text{ V}$ , $V_{EE} = 0\text{ V}$ , $I_O = 3\text{ mA}$                   |          | 250       | 350            | mV            |
| $I_{LKG}$ | Open-drain output leakage current (TLV7022 only) | $V_S = 5\text{ V}$ , $V_{ID} = +0.1\text{ V}$ (output high), $V_{PULLUP} = V_{CC}$ |          | 100       |                | pA            |
| CMRR      | Common-mode rejection ratio                      | $V_{EE} < V_{CM} < V_{CC}$ , $V_S = 5\text{ V}$                                    |          | 73        |                | dB            |
| PSRR      | Power supply rejection ratio                     | $V_S = 1.8\text{ V to }5\text{ V}$ , $V_{CM} = V_S / 2$                            |          | 77        |                | dB            |
| $I_{SC}$  | Short-circuit current                            | $V_S = 5\text{ V}$ , sourcing (for TLV7012 only)                                   |          | 29        |                | mA            |
|           |  | $V_S = 5\text{ V}$ , sinking   |          | 33        |                |               |
| $I_{CC}$  | Supply current / Channel                         | $V_S = 1.8\text{ V}$ , no load, $V_{ID} = -0.1\text{ V}$ (Output Low)              |          | 4.7       | 9              | $\mu\text{A}$ |

## 6.11 Switching Characteristics (Dual)

Typical values are at  $T_A = 25^\circ\text{C}$ ,  $V_S = 5\text{ V}$ ,  $V_{CM} = V_S / 2$ ;  $C_L = 15\text{ pF}$ , input overdrive = 100 mV (unless otherwise noted).

| PARAMETER |  | TEST CONDITIONS  | MIN | TYP | MAX | UNIT          |
|-----------|--|--|-----|-----|-----|---------------|
| $t_{PHL}$ | Propagation delay time, high to low (RP = 4.99 k $\Omega$ TLV7022 only) <sup>(1)</sup> | Midpoint of input to midpoint of output, $V_{OD} = 100\text{ mV}$  |     | 310 |     | ns            |
| $t_{PLH}$ | Propagation delay time, low to high (RP = 4.99 k $\Omega$ TLV7022 only) <sup>(1)</sup> | Midpoint of input to midpoint of output, $V_{OD} = 100\text{ mV}$  |     | 260 |     | ns            |
| $t_R$     | Rise time (TLV7012 only)   | Measured from 20% to 80%   |     | 5   |     | ns            |
| $t_F$     | Fall time  | Measured from 20% to 80%   |     | 5   |     | ns            |
| $t_{ON}$  | Power-up time  | During power on, $V_{CC}$ must exceed 1.6V for 20 $\mu\text{s}$ before the output is in a correct state. |     | 20  |     | $\mu\text{s}$ |

(1) The lower limit for RP is 650  $\Omega$

## 6.12 Timing Diagrams

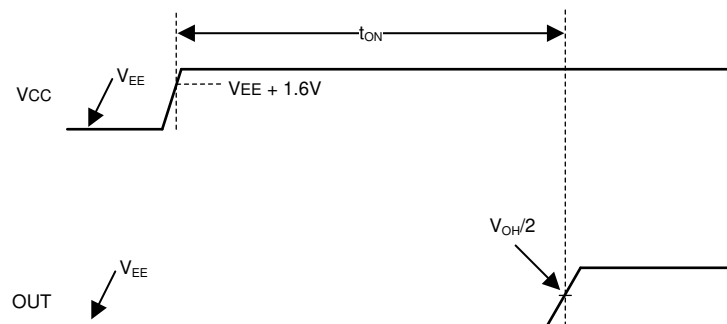
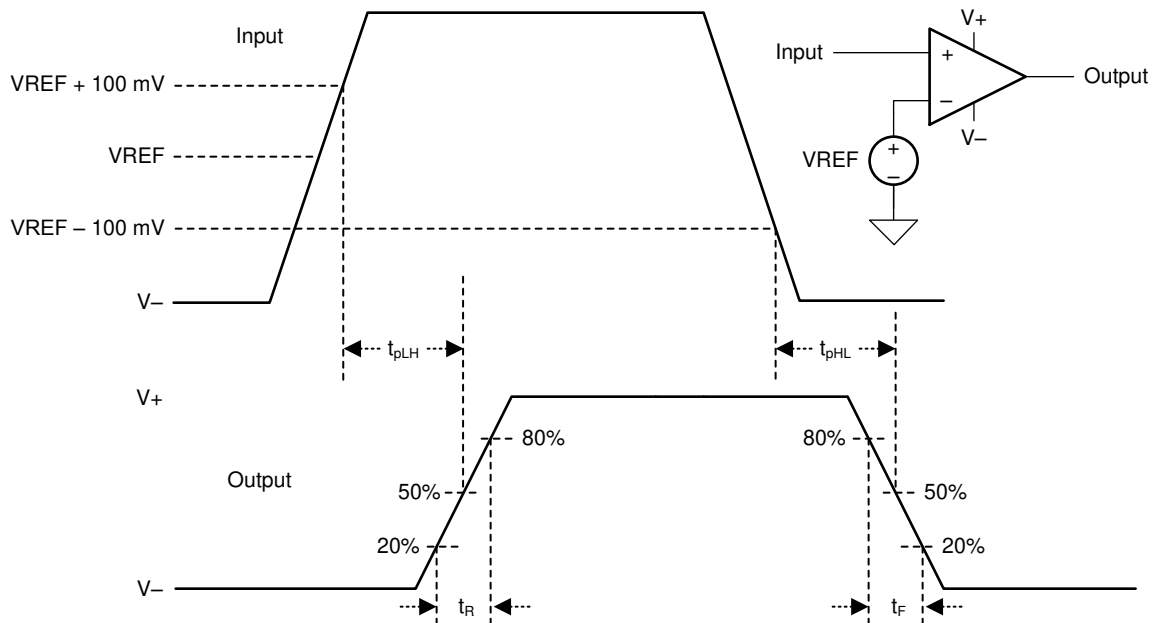

Figure 1. Start-Up Time Timing Diagram (IN+ > IN-)



**Timing Diagrams (continued)**



**Figure 2. Propagation Delay Timing Diagram**

### 6.13 Typical Characteristics

$T_A = 25^\circ\text{C}$ ,  $V_{CC} = 5\text{ V}$ ,  $V_{EE} = 0\text{ V}$ ,  $V_{CM} = V_{CC}/2$ ,  $C_L = 15\text{ pF}$

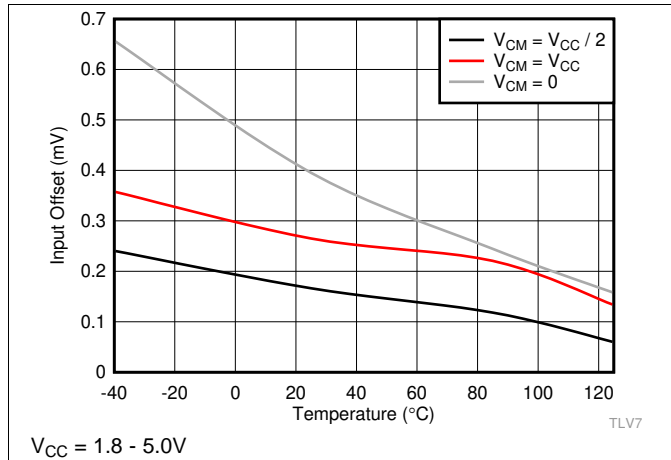

Figure 3. Input Offset vs. Temperature

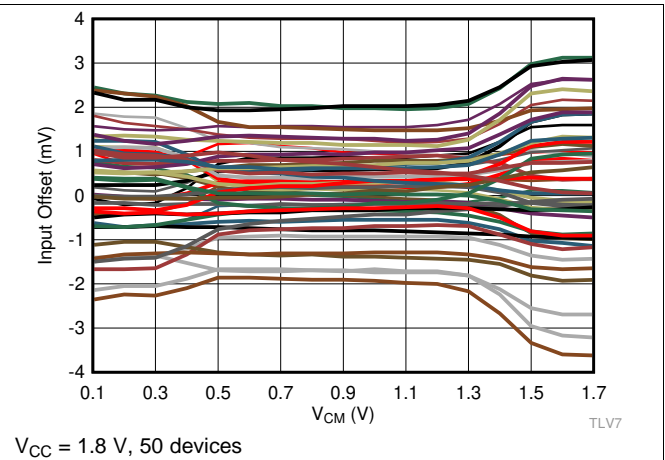

Figure 4. Input Offset Voltage vs.  $V_{CM}$

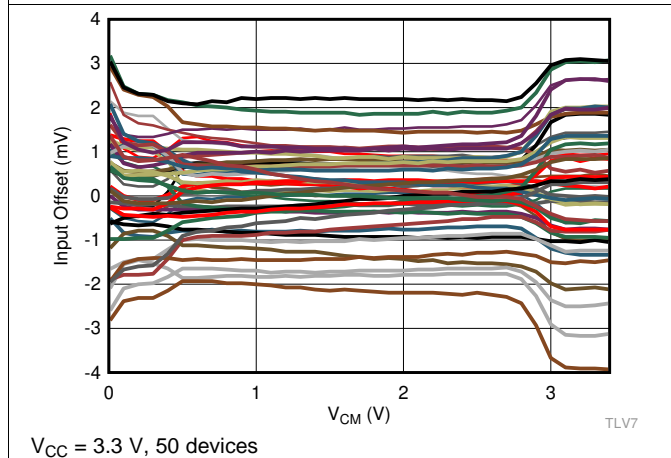

Figure 5. Input Offset Voltage vs.  $V_{CM}$

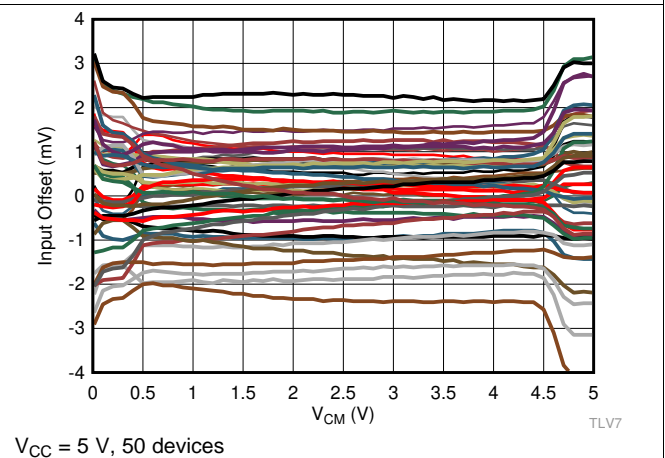

Figure 6. Input Offset Voltage vs.  $V_{CM}$

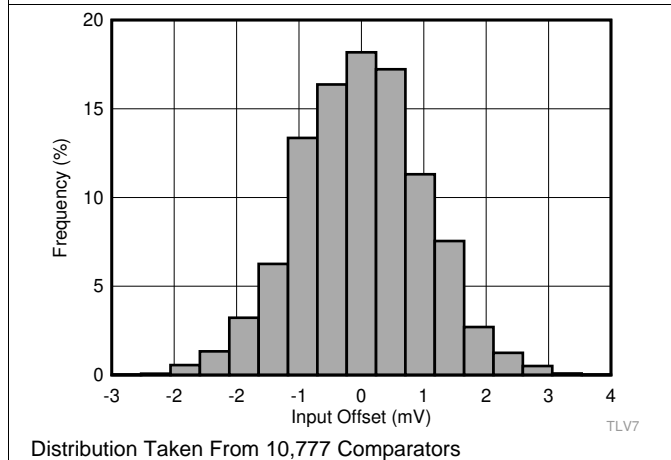

Figure 7. Input Offset Voltage Histogram

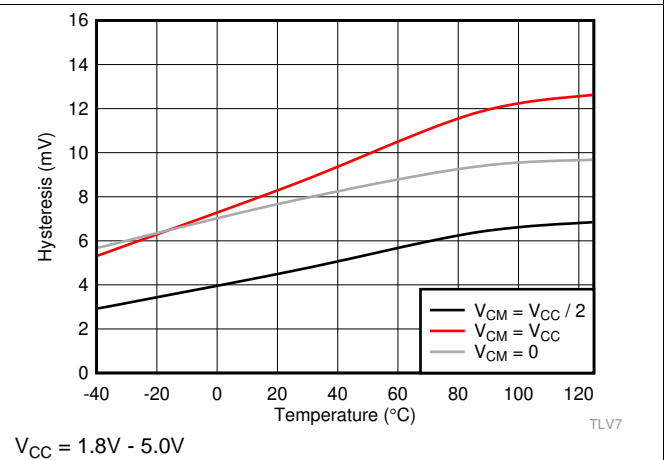
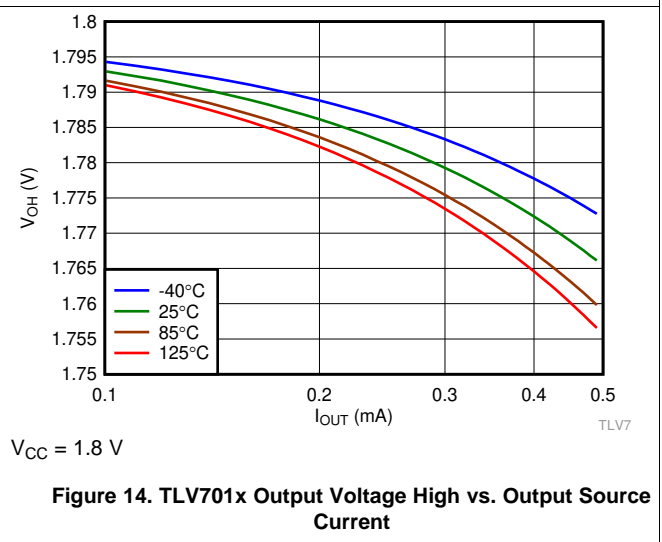
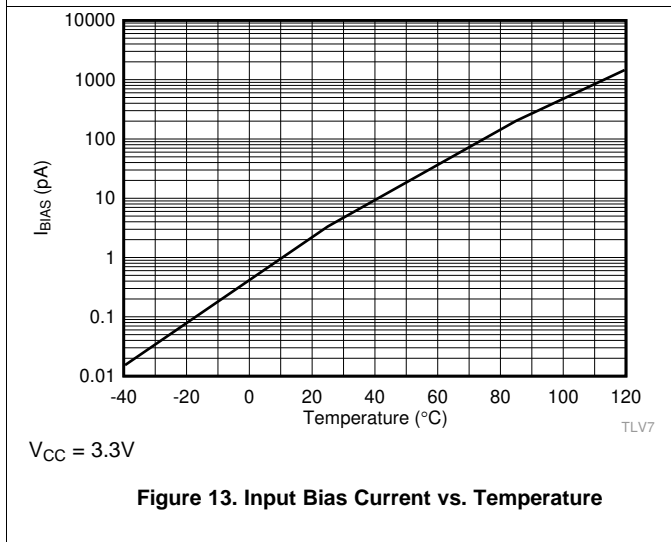
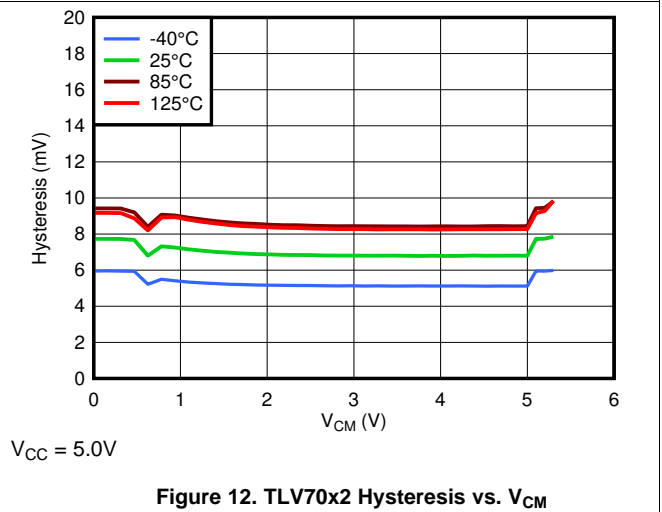
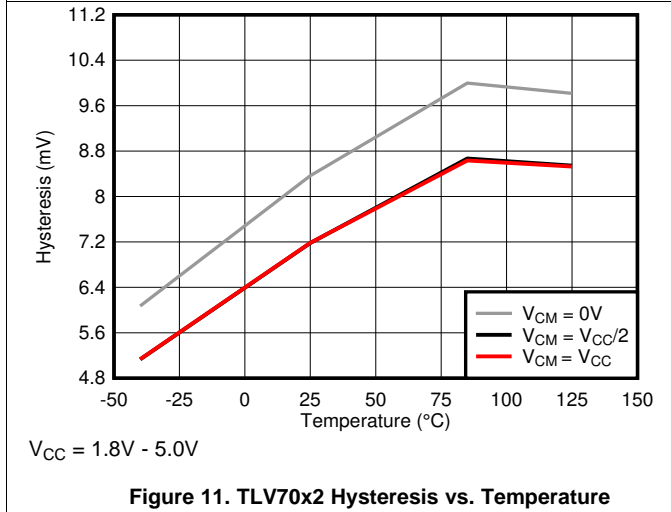
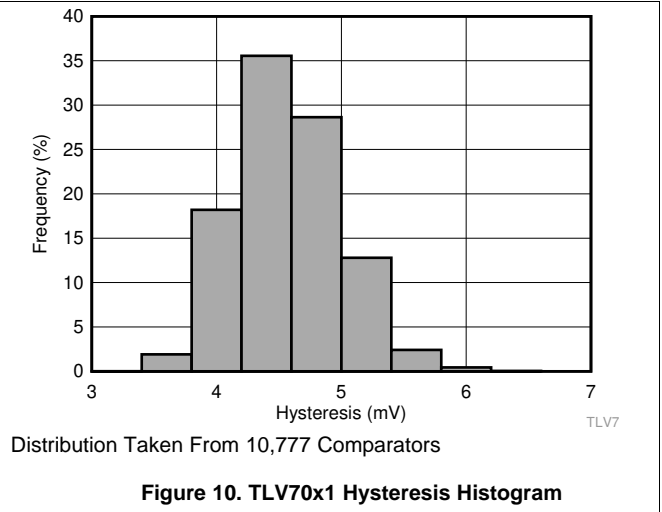
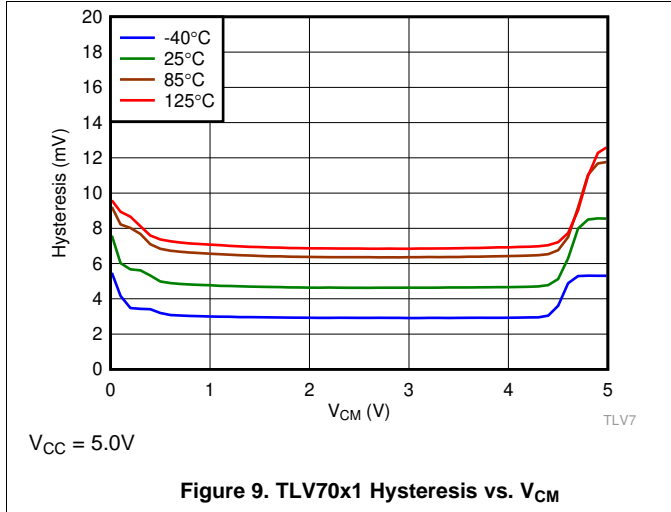

Figure 8. TLV70x1 Hysteresis vs. Temperature

Typical Characteristics (continued)

$T_A = 25^\circ\text{C}$ ,  $V_{CC} = 5\text{ V}$ ,  $V_{EE} = 0\text{ V}$ ,  $V_{CM} = V_{CC}/2$ ,  $C_L = 15\text{ pF}$



### Typical Characteristics (continued)

$T_A = 25^\circ\text{C}$ ,  $V_{CC} = 5\text{ V}$ ,  $V_{EE} = 0\text{ V}$ ,  $V_{CM} = V_{CC}/2$ ,  $C_L = 15\text{ pF}$

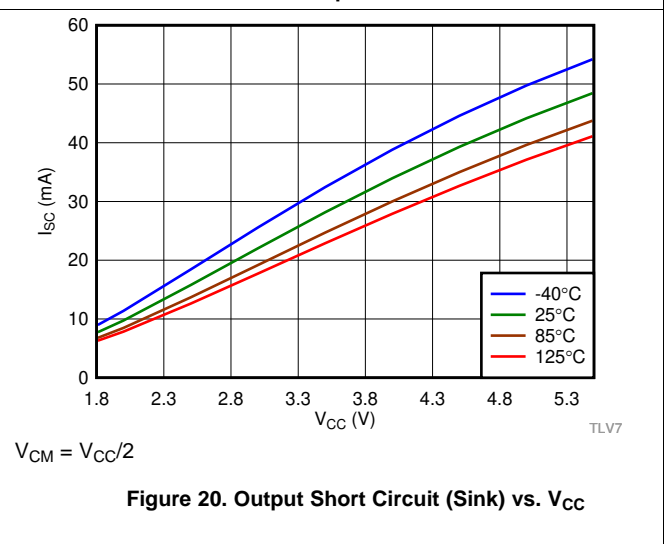
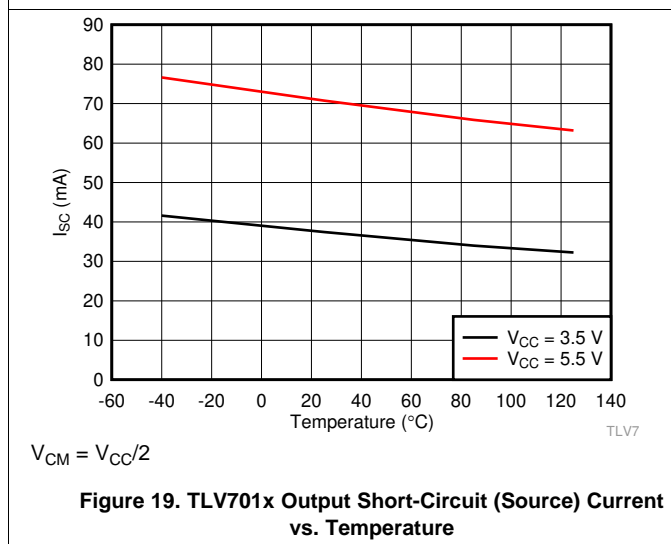
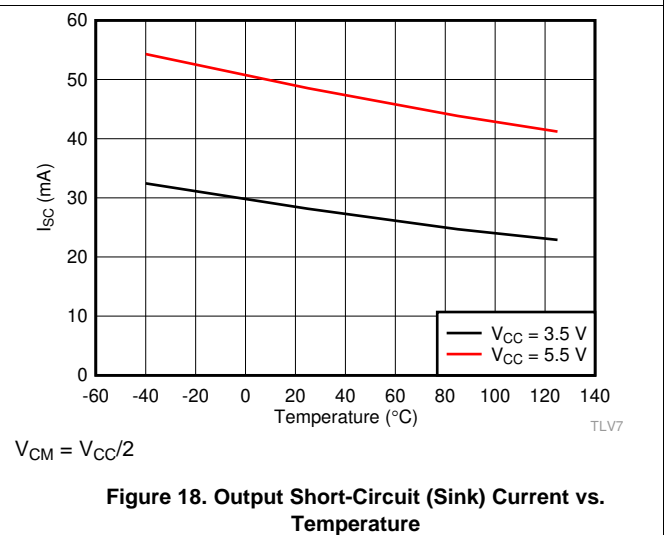
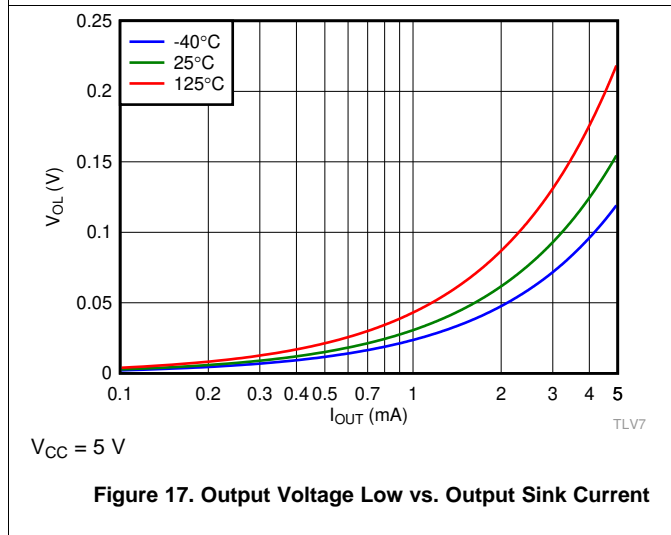
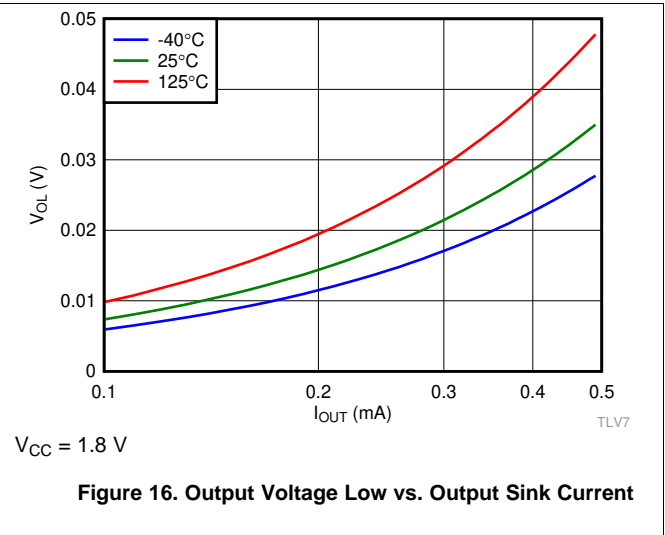
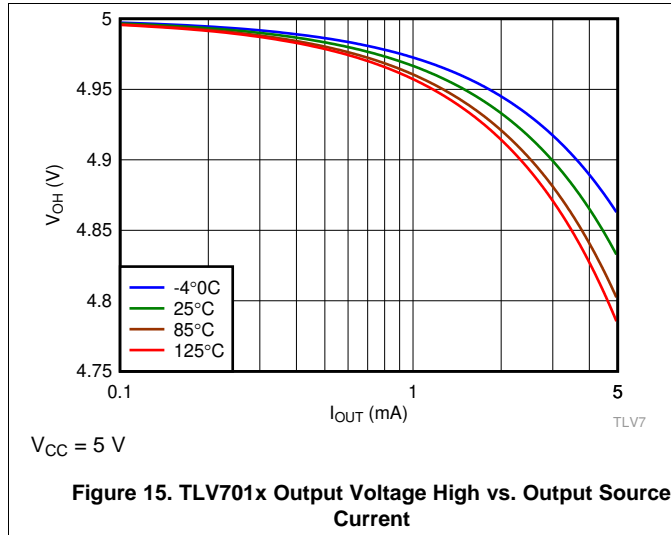

Typical Characteristics (continued)

$T_A = 25^\circ\text{C}$ ,  $V_{CC} = 5\text{ V}$ ,  $V_{EE} = 0\text{ V}$ ,  $V_{CM} = V_{CC}/2$ ,  $C_L = 15\text{ pF}$

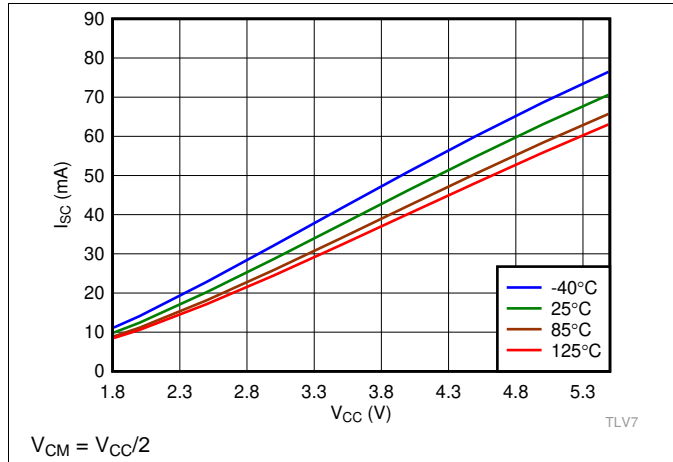

Figure 21. TLV701x Output Short Circuit (Source) vs.  $V_{CC}$

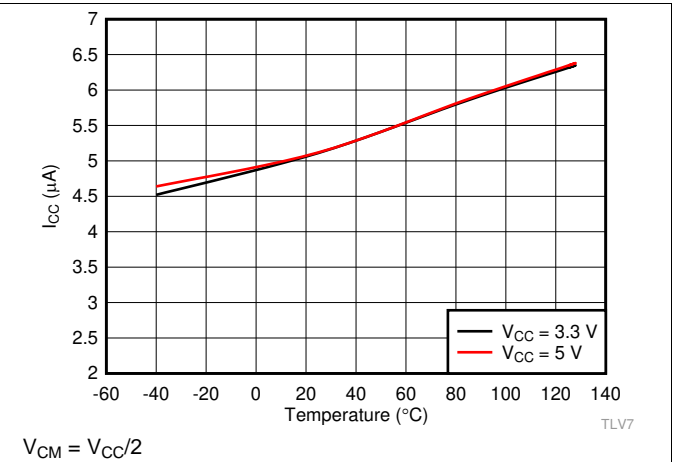

Figure 22.  $I_{CC}$  vs. Temperature

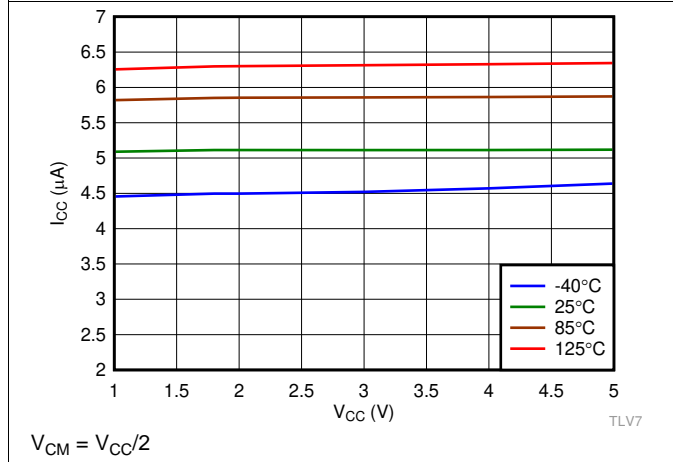

Figure 23.  $I_{CC}$  vs.  $V_{CC}$

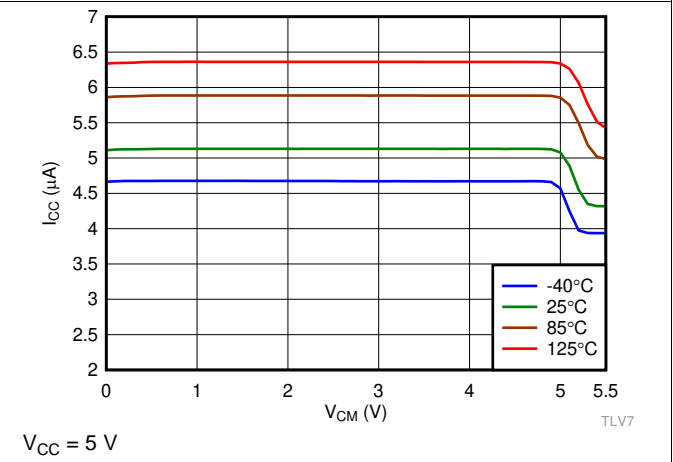

Figure 24.  $I_{CC}$  vs.  $V_{CM}$

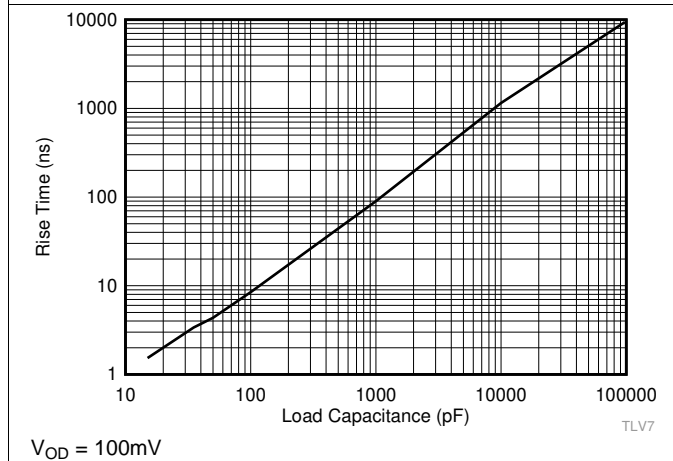

Figure 25. TLV701x Output Rise Time vs. Load Capacitance

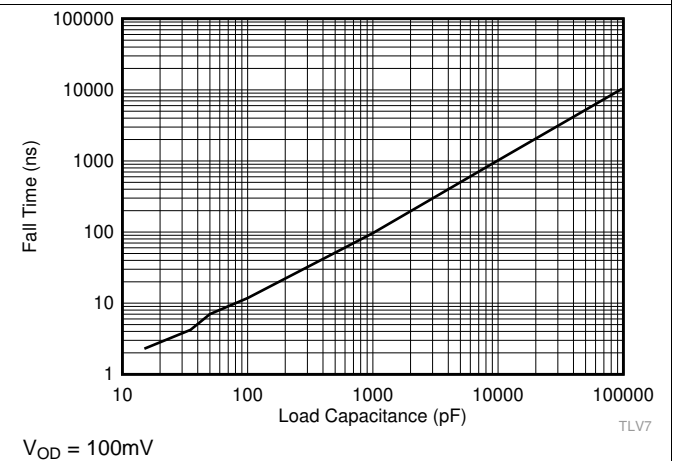
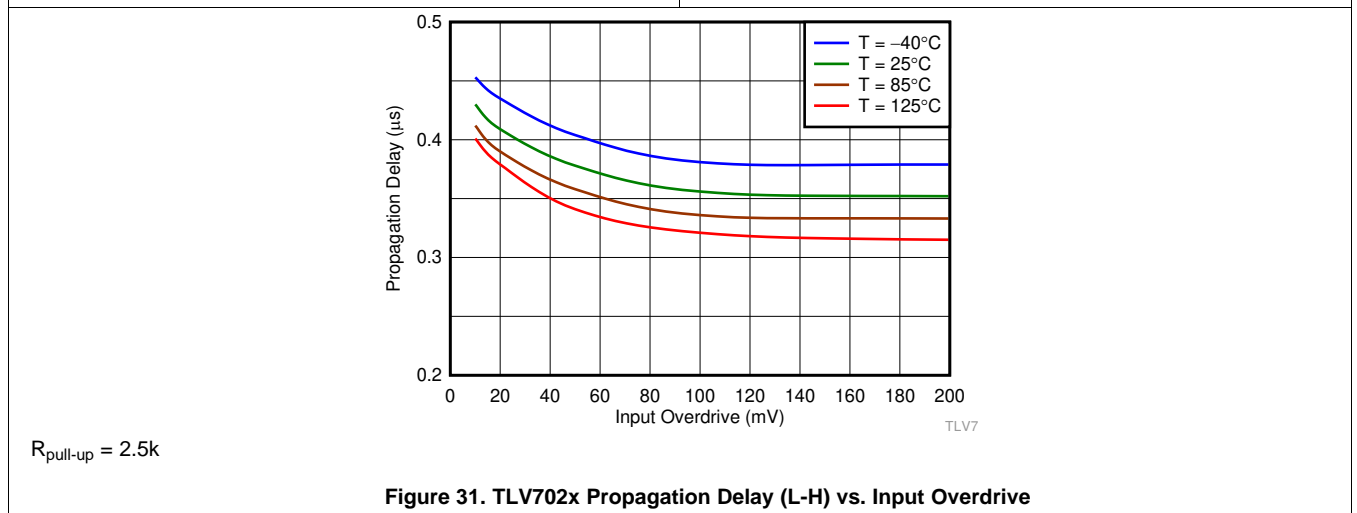
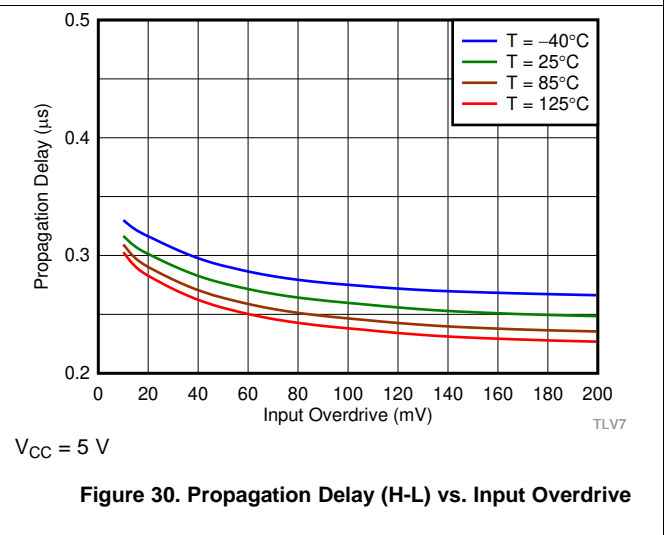
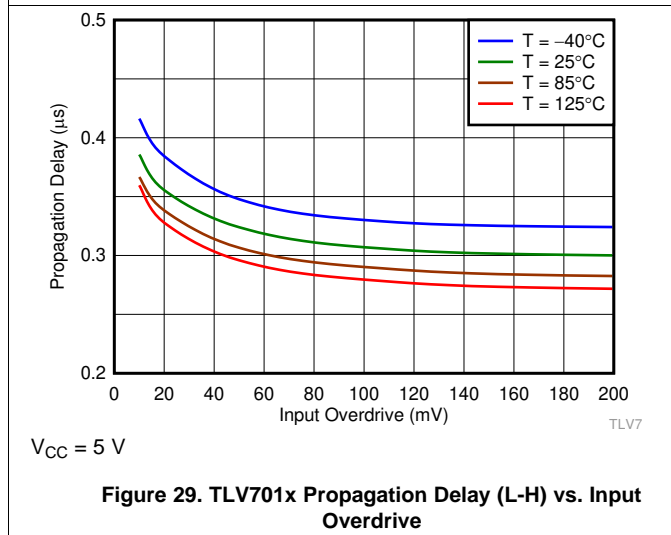
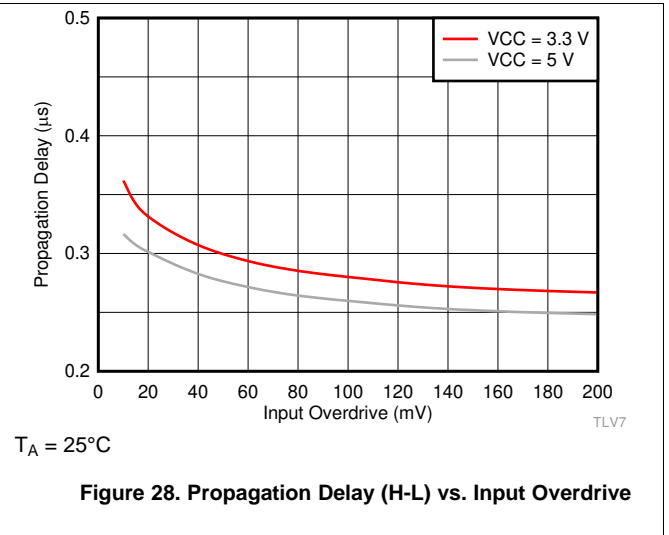
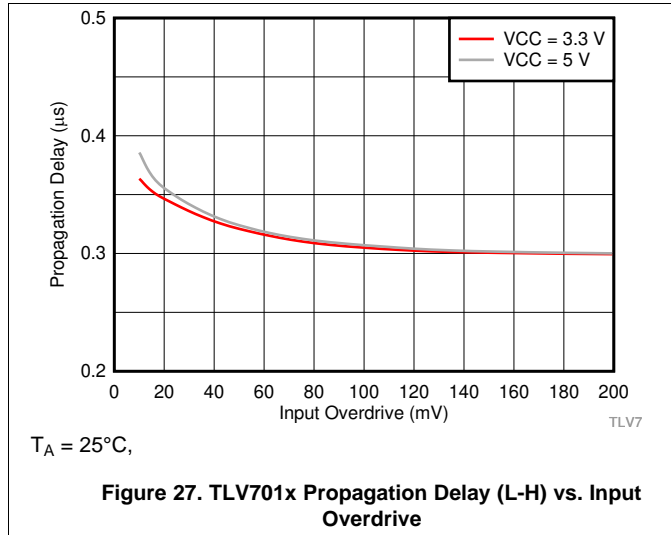

Figure 26. Output Fall Time vs. Load Capacitance

### Typical Characteristics (continued)

$T_A = 25^\circ\text{C}$ ,  $V_{CC} = 5\text{ V}$ ,  $V_{EE} = 0\text{ V}$ ,  $V_{CM} = V_{CC}/2$ ,  $C_L = 15\text{ pF}$



## 7 Detailed Description

### 7.1 Overview

The TLV701x and TLV702x devices are single-channel, micro-power comparators with push-pull and open-drain outputs. Operating down to 1.6 V and consuming only 5  $\mu$ A, the TLV701x and TLV702x are ideally suited for portable and industrial applications. The comparators are available in leadless and leaded packages to offer significant board space saving in space-challenged designs.

### 7.2 Functional Block Diagram

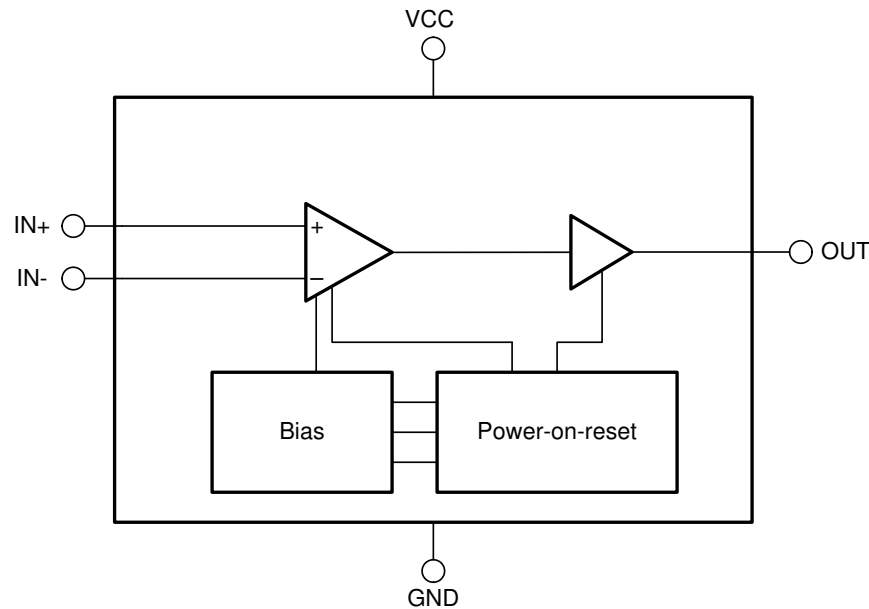

Copyright © 2017, Texas Instruments Incorporated

### 7.3 Feature Description

The TLV701x (push-pull) and TLV702x (open-drain) devices are micro-power comparators that are capable of operating at low voltages. The TLV701x and TLV702x feature a rail-to-rail input stage capable of operating up to 100 mV beyond the VCC power supply rail. The comparators also feature a push-pull and open-drain output stage with internal hysteresis.

### 7.4 Device Functional Modes

The TLV701x and TLV702x have a Power-on-Reset (POR) circuit. While the power supply ( $V_S$ ) is ramping up or ramping down, the POR circuitry will be activated.

For the TLV701x, the POR circuit will hold the output low (at  $V_{EE}$ ) while activated.

For the TLV702x, the POR circuit will keep the output high impedance (logical high) while activated.

When the supply voltage is greater than, or equal to, the minimum supply voltage, the comparator output reflects the state of the differential input ( $V_{ID}$ ).

#### 7.4.1 Inputs

The TLV701x and TLV702x input common-mode extends from  $V_{EE}$  to 100 mV above  $V_{CC}$ . The differential input voltage ( $V_{ID}$ ) can be any voltage within these limits. No phase-inversion of the comparator output will occur when the input pins exceed  $V_{CC}$  and  $V_{EE}$ .

## Device Functional Modes (continued)

While TI recommends operating the TLV701x and TLV702x within the specified common-mode range, the inputs are fault tolerant to voltages up to 5.5 V independent of the applied  $V_{CC}$  value. Fault tolerant is defined as maintaining the same high input impedance when  $V_{CC}$  is unpowered or within the recommended operating range. Because the inputs of the TLV701x and TLV702x are fault tolerant, the inputs to the comparator can be any value between 0 V and 5.5 V while  $V_{CC}$  is ramping up. This feature allows any supply and input driven sequence as long as the input value and supply are within the specified ranges. In this case, no current limiting resistor is required. This is possible since the  $V_{CC}$  is isolated from the inputs such that it maintains its value even when a higher voltage is applied to the input.

The input bias current is typically 1 pA for input voltages between  $V_{CC}$  and  $V_{EE}$ . The comparator inputs are protected from undervoltage by internal diodes connected to  $V_{EE}$ . As the input voltage goes under  $V_{EE}$ , the protection diodes become forward biased and begin to conduct causing the input bias current to increase exponentially. Input bias current typically doubles for 10°C temperature increases.

### 7.4.2 Internal Hysteresis

The device hysteresis transfer curve is shown in [Figure 32](#). This curve is a function of three components:  $V_{TH}$ ,  $V_{OS}$ , and  $V_{HYST}$ :

- $V_{TH}$  is the actual set voltage or threshold trip voltage.
- $V_{OS}$  is the internal offset voltage between  $V_{IN+}$  and  $V_{IN-}$ . This voltage is added to  $V_{TH}$  to form the actual trip point at which the comparator must respond to change output states.
- $V_{HYST}$  is the internal hysteresis (or trip window) that is designed to reduce comparator sensitivity to noise (4.2 mV for the TLV7011).

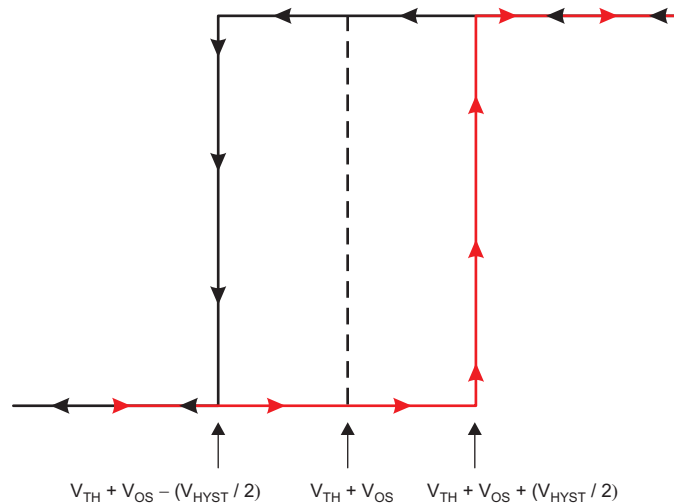

**Figure 32. Hysteresis Transfer Curve**

### 7.4.3 Output

The TLV701x feature a push-pull output stage eliminating the need for an external pull-up resistor. On the other hand, the TLV702x feature an open-drain output stage enabling the output logic levels to be pulled up to an external source independent of the supply voltage.



## 8 Application and Implementation

### NOTE

Information in the following applications sections is not part of the TI component specification, and TI does not warrant its accuracy or completeness. TI's customers are responsible for determining suitability of components for their purposes. Customers should validate and test their design implementation to confirm system functionality.

### 8.1 Application Information

The TLV701x and TLV702x are micro-power comparators with reasonable response time. The comparators have a rail-to-rail input stage that can monitor signals beyond the positive supply rail with integrated hysteresis. When higher levels of hysteresis are required, positive feedback can be externally added. The push-pull output stage of the TLV701x is optimal for reduced power budget applications and features no shoot-through current. When level shifting or wire-ORing of the comparator outputs is needed, the TLV702x with its open-drain output stage is well suited to meet the system needs. In either case, the wide operating voltage range, low quiescent current, and micro-package of the TLV701x and TLV702x make these comparators excellent candidates for battery-operated and portable, handheld designs.

#### 8.1.1 Inverting Comparator With Hysteresis for TLV701x

The inverting comparator with hysteresis requires a three-resistor network that is referenced to the comparator supply voltage ( $V_{CC}$ ), as shown in Figure 33. When  $V_{IN}$  at the inverting input is less than  $V_A$ , the output voltage is high (for simplicity, assume  $V_O$  switches as high as  $V_{CC}$ ). The three network resistors can be represented as  $R1 \parallel R3$  in series with  $R2$ . Equation 1 defines the high-to-low trip voltage ( $V_{A1}$ ).

$$V_{A1} = V_{CC} \times \frac{R2}{(R1 \parallel R3) + R2} \quad (1)$$

When  $V_{IN}$  is greater than  $V_A$ , the output voltage is low, very close to ground. In this case, the three network resistors can be presented as  $R2 \parallel R3$  in series with  $R1$ . Use Equation 2 to define the low to high trip voltage ( $V_{A2}$ ).

$$V_{A2} = V_{CC} \times \frac{R2 \parallel R3}{R1 + (R2 \parallel R3)} \quad (2)$$

Equation 3 defines the total hysteresis provided by the network.

$$\Delta V_A = V_{A1} - V_{A2} \quad (3)$$

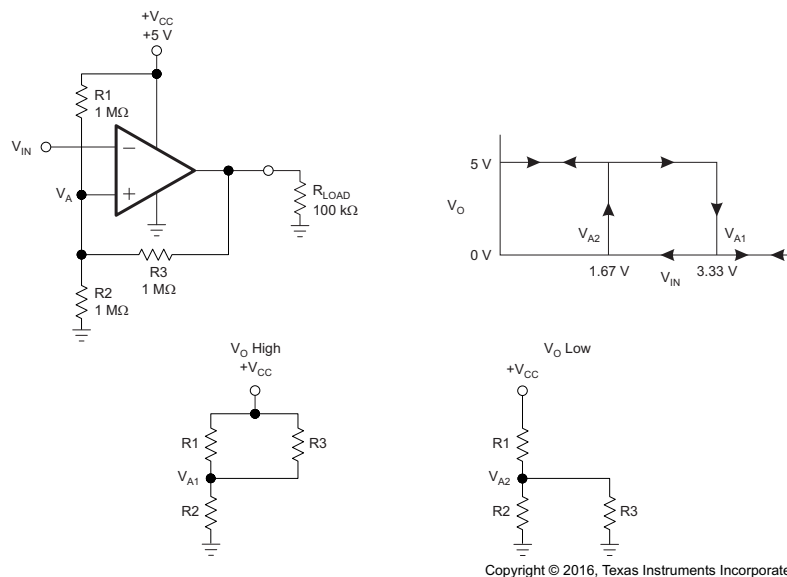

Figure 33. TLV701x in an Inverting Configuration With Hysteresis

## Application Information (continued)

### 8.1.2 Noninverting Comparator With Hysteresis for TLV701x

A noninverting comparator with hysteresis requires a two-resistor network, as shown in Figure 34, and a voltage reference ( $V_{REF}$ ) at the inverting input. When  $V_{IN}$  is low, the output is also low. For the output to switch from low to high,  $V_{IN}$  must rise to  $V_{IN1}$ . Use Equation 4 to calculate  $V_{IN1}$ .

$$V_{IN1} = R1 \times \frac{V_{REF}}{R2} + V_{REF} \tag{4}$$

When  $V_{IN}$  is high, the output is also high. For the comparator to switch back to a low state,  $V_{IN}$  must drop to  $V_{IN2}$  such that  $V_A$  is equal to  $V_{REF}$ . Use Equation 5 to calculate  $V_{IN2}$ .

$$V_{IN2} = \frac{V_{REF} (R1 + R2) - V_{CC} \times R1}{R2} \tag{5}$$

The hysteresis of this circuit is the difference between  $V_{IN1}$  and  $V_{IN2}$ , as shown in Equation 6.

$$\Delta V_{IN} = V_{CC} \times \frac{R1}{R2} \tag{6}$$

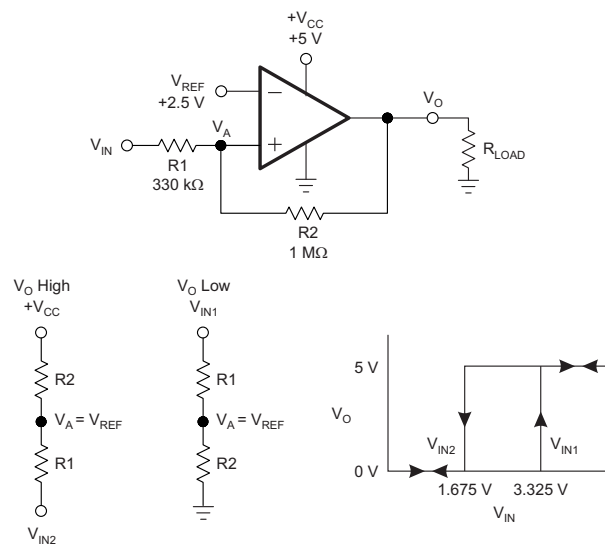

Copyright © 2016, Texas Instruments Incorporated

Figure 34. TLV701x in a Noninverting Configuration With Hysteresis

## 8.2 Typical Applications

### 8.2.1 Window Comparator

Window comparators are commonly used to detect undervoltage and overvoltage conditions. Figure 35 shows a simple window comparator circuit.

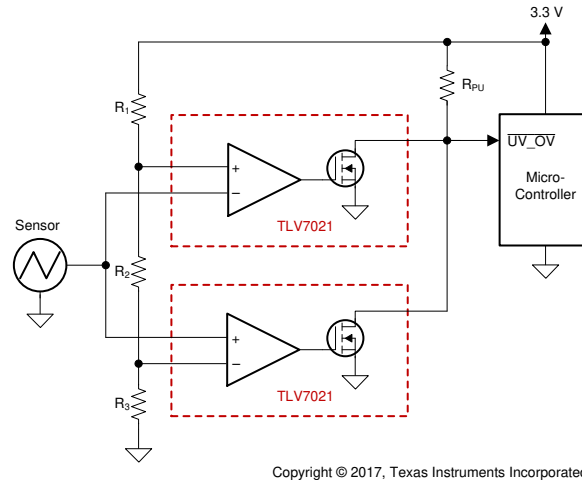

**Figure 35. Window Comparator**

#### 8.2.1.1 Design Requirements

For this design, follow these design requirements:

- Alert (logic low output) when an input signal is less than 1.1 V
- Alert (logic low output) when an input signal is greater than 2.2 V
- Alert signal is active low
- Operate from a 3.3-V power supply

#### 8.2.1.2 Detailed Design Procedure

Configure the circuit as shown in Figure 35. Connect  $V_{CC}$  to a 3.3-V power supply and  $V_{EE}$  to ground. Make  $R_1$ ,  $R_2$  and  $R_3$  each 10-M $\Omega$  resistors. These three resistors are used to create the positive and negative thresholds for the window comparator ( $V_{TH+}$  and  $V_{TH-}$ ). With each resistor being equal,  $V_{TH+}$  is 2.2 V and  $V_{TH-}$  is 1.1 V. Large resistor values such as 10-M $\Omega$  are used to minimize power consumption. The sensor output voltage is applied to the inverting and noninverting inputs of the two TLV702x's. The TLV7021 is used for its open-drain output configuration. Using the TLV702x allows the two comparator outputs to be Wire-Or'd together. The respective comparator outputs will be low when the sensor is less than 1.1 V or greater than 2.2 V.  $V_{OUT}$  will be high when the sensor is in the range of 1.1 V to 2.2 V.

## Typical Applications (continued)

### 8.2.1.3 Application Curve

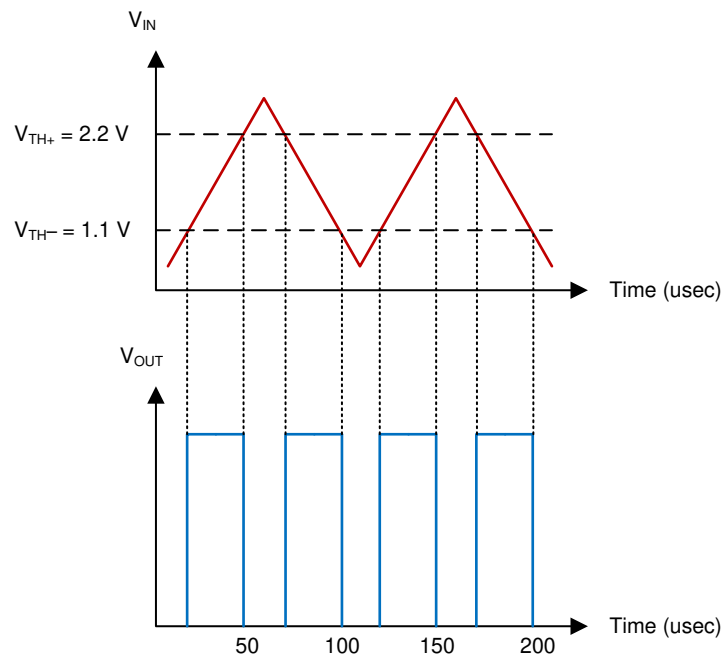
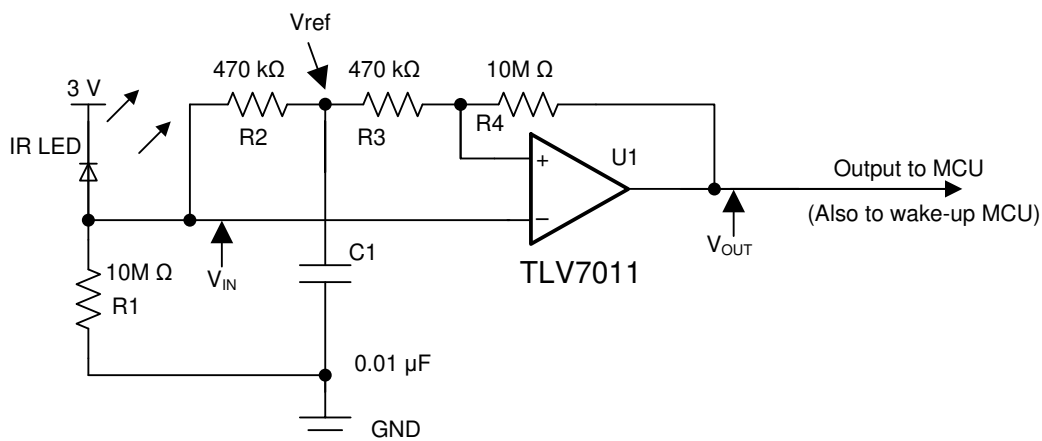

Figure 36. Window Comparator Results

### 8.2.2 IR Receiver Analog Front End

A single TLV7011 device can be used to build a complete IR receiver analog front end (AFE). The nanoamp quiescent current and low input bias current make it possible to be powered with a coin cell battery, which could last for years.



Copyright © 2017, Texas Instruments Incorporated

Figure 37. IR Receiver Analog Front End Using TLV7011

## Typical Applications (continued)

### 8.2.2.1 Design Requirements

For this design, follow these design requirements:

- Use a proper resistor ( $R_1$ ) value to generate an adequate signal amplitude applied to the inverting input of the comparator.
- The low input bias current  $I_B$  (2 pA typical) ensures that a greater value of  $R_1$  to be used.
- The RC constant value ( $R_2$  and  $C_1$ ) must support the targeted data rate (that is, 9,600 bauds) to maintain a valid tripping threshold.
- The hysteresis introduced with  $R_3$  and  $R_4$  helps to avoid spurious output toggles.

### 8.2.2.2 Detailed Design Procedure

The IR receiver AFE design is highly streamlined and optimized.  $R_1$  converts the IR light energy induced current into voltage and applies to the inverting input of the comparator. Because a reverse biased IR LED is used as the IR receiver, a higher  $I/V$  transimpedance gain is required to boost the amplitude of reduced current. A 10M resistor is used as  $R_1$  to support a 1-V, 100-nA transimpedance gain. This is made possible with the picoamps Input bias current  $I_B$  (5pA typical). The RC network of  $R_2$  and  $C_1$  establishes a reference voltage  $V_{ref}$  which tracks the mean amplitude of the IR signal. The RC constant of  $R_2$  and  $C_1$  (about 4.7 ms) is chosen for  $V_{ref}$  to track the received IR current fluctuation but not the actual data bit stream. The noninverting input is connected to  $V_{ref}$  and the output over the  $R_3$  and  $R_4$  resistor network which provides additional hysteresis for improved guard against spurious toggles.

To reduce the current drain from the coin cell battery, data transmission must be short and infrequent.

### 8.2.2.3 Application Curve

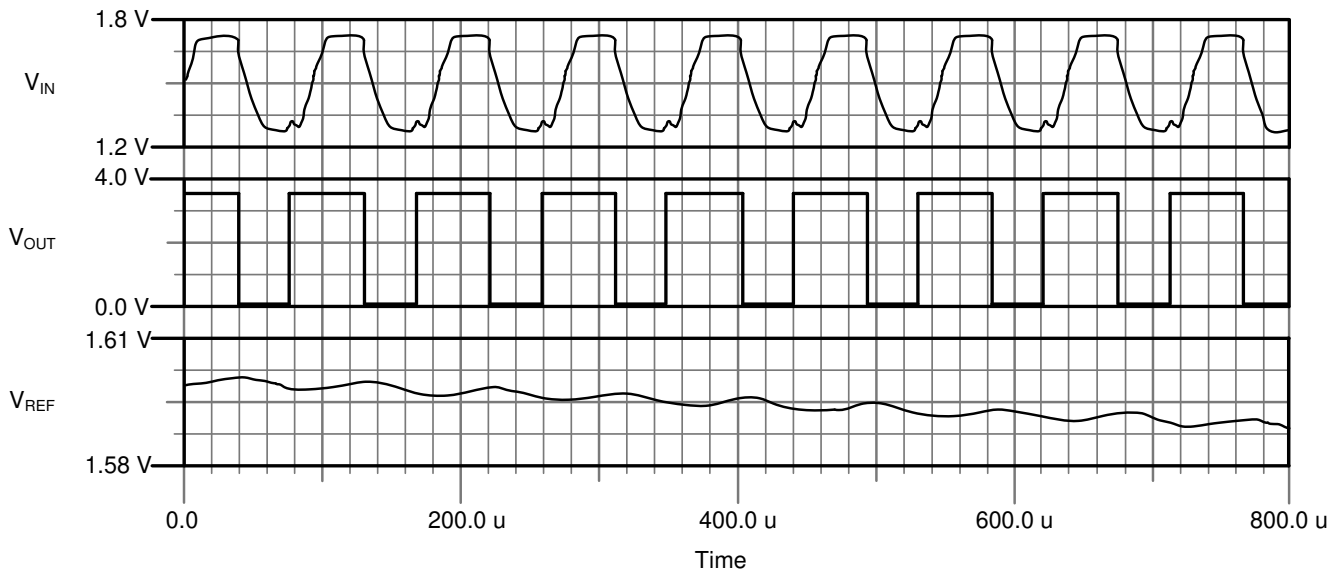
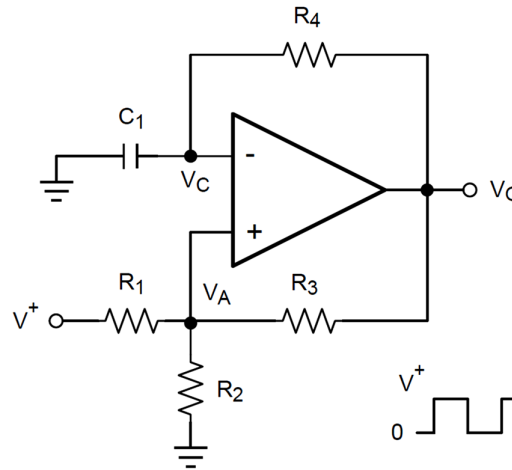

Figure 38. IR Receiver AFE Waveforms

## Typical Applications (continued)

### 8.2.3 Square-Wave Oscillator

Square-wave oscillator can be used as low cost timing reference or system supervisory clock source.



**Figure 39. Square-Wave Oscillator**

#### 8.2.3.1 Design Requirements

The square-wave period is determined by the RC time constant of the capacitor and resistor. The maximum frequency is limited by propagation delay of the device and the capacitance load at the output. The low input bias current allows a lower capacitor value and larger resistor value combination for a given oscillator frequency, which may help to reduce BOM cost and board space.

#### 8.2.3.2 Detailed Design Procedure

The oscillation frequency is determined by the resistor and capacitor values. The following calculation provides details of the steps.

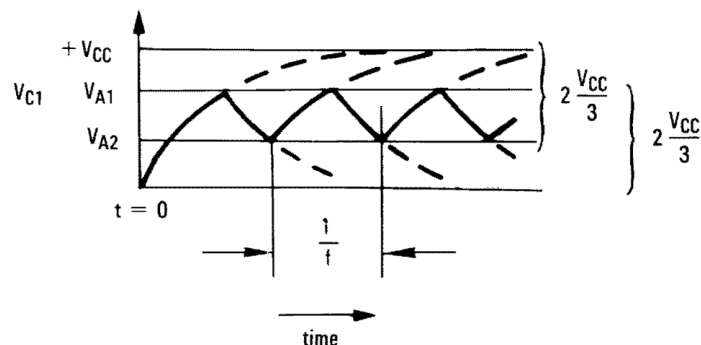

**Figure 40. Square-Wave Oscillator Timing Thresholds**

First consider the output of Figure Figure 39 is high which indicates the inverted input  $V_C$  is lower than the noninverting input ( $V_A$ ). This causes the  $C_1$  to be charged through  $R_4$ , and the voltage  $V_C$  increases until it is equal to the noninverting input. The value of  $V_A$  at the point is calculated by Equation 7.

$$V_{A1} = \frac{V_{CC} \times R_2}{R_2 + R_1 \parallel R_3} \quad (7)$$

if  $R_1 = R_2 = R_3$ , then  $V_{A1} = 2 V_{CC} / 3$

### Typical Applications (continued)

At this time the comparator output trips pulling down the output to the negative rail. The value of  $V_A$  at this point is calculated by Equation 8.

$$V_{A2} = \frac{V_{CC}(R_2 I R_3)}{R_1 + R_2 I R_3} \tag{8}$$

if  $R_1 = R_2 = R_3$ , then  $V_{A2} = V_{CC}/3$

The  $C_1$  now discharges though the  $R_4$ , and the voltage  $V_{CC}$  decreases until it reaches  $V_{A2}$ . At this point, the output switches back to the starting state. The oscillation period equals to the time duration from for  $C_1$  from  $2V_{CC}/3$  to  $V_{CC} / 3$  then back to  $2V_{CC}/3$ , which is given by  $R_4 C_1 \times \ln 2$  fro each trip. Therefore, the total time duration is calculated as  $2 R_4 C_1 \times \ln 2$ . The oscillation frequency can be obtained by Equation 9:

$$f = 1 / (2 R_4 \times C_1 \times \ln 2) \tag{9}$$

#### 8.2.3.3 Application Curve

Figure 41 shows the simulated results of tan oscillator using the following component values:

- $R_1 = R_2 = R_3 = R_4 = 100 \text{ k}\Omega$
- $C_1 = 100 \text{ pF}$ ,  $C_L = 20 \text{ pF}$
- $V_+ = 5 \text{ V}$ ,  $V_- = \text{GND}$
- $C_{\text{stray}}$  (not shown) from  $V_A$  TO GND =  $10 \text{ pF}$

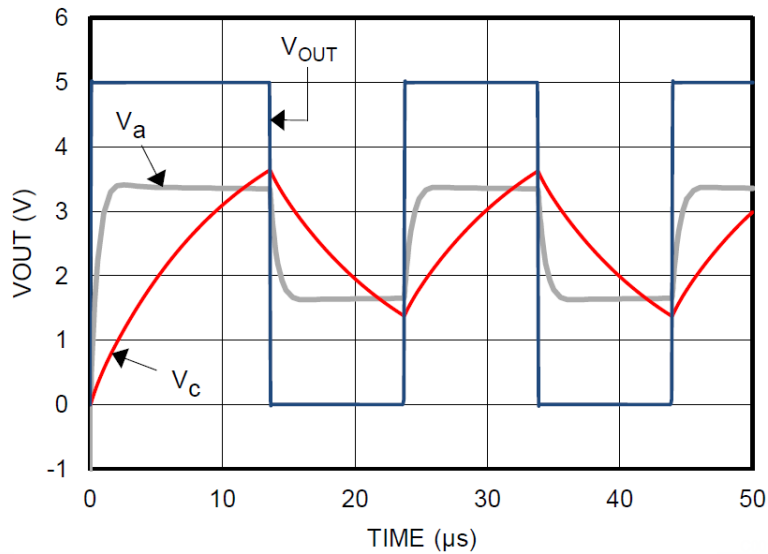

**Figure 41. Square-Wave Oscillator Output Waveform**

## 9 Power Supply Recommendations

The TLV701x and TLV702x have a recommended operating voltage range ( $V_S$ ) of 1.6 V to 5.5 / 6.5 V.  $V_S$  is defined as  $V_{CC} - V_{EE}$ . Therefore, the supply voltages used to create  $V_S$  can be single-ended or bipolar. For example, single-ended supply voltages of 5 V and 0 V and bipolar supply voltages of +2.5 V and -2.5 V create comparable operating voltages for  $V_S$ . However, when bipolar supply voltages are used, it is important to realize that the logic low level of the comparator output is referenced to  $V_{EE}$ .

Output capacitive loading and output toggle rate will cause the average supply current to rise over the quiescent current.

## 10 Layout

### 10.1 Layout Guidelines

To reduce PCB fabrication cost and improve reliability, TI recommends using a 4-mil via at the center pad connected to the ground trace or plane on the bottom layer.

A power-supply bypass capacitor of 100 nF is recommended when supply output impedance is high, supply traces are long, or when excessive noise is expected on the supply lines. Bypass capacitors are also recommended when the comparator output drives a long trace or is required to drive a capacitive load. Due to the fast rising and falling edge rates and high-output sink and source capability of the TLV7011 and TLV7021 output stages, higher than normal quiescent current can be drawn from the power supply. Under this circumstance, the system would benefit from a bypass capacitor across the supply pins.

### 10.2 Layout Example

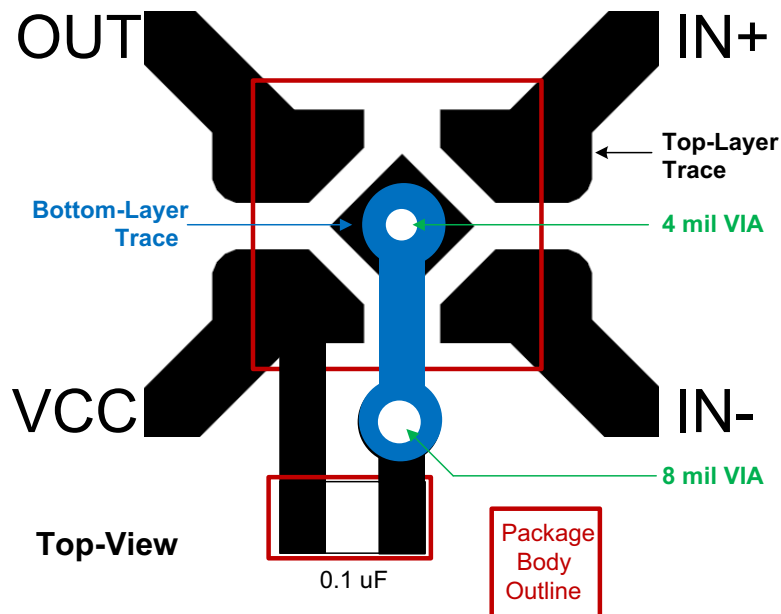

**Figure 42. Layout Example**



## 11 Device and Documentation Support

### 11.1 Device Support

#### 11.1.1 Development Support

##### 11.1.1.1 Evaluation Module

An evaluation module (EVM) is available to assist in the initial circuit performance evaluation using the TLV70x1 device family. The [TLV7011 Micro-Power Comparator Dip Adaptor Evaluation Module](#) can be requested at the Texas Instruments website through the product folder or purchased directly from the TI eStore.

### 11.2 Related Links

The table below lists quick access links. Categories include technical documents, support and community resources, tools and software, and quick access to order now.

**Table 1. Related Links**

| PARTS   | PRODUCT FOLDER             | ORDER NOW                  | TECHNICAL DOCUMENTS        | TOOLS & SOFTWARE           | SUPPORT & COMMUNITY        |
|---------|----------------------------|----------------------------|----------------------------|----------------------------|----------------------------|
| TLV7011 | <a href="#">Click here</a> | <a href="#">Click here</a> | <a href="#">Click here</a> | <a href="#">Click here</a> | <a href="#">Click here</a> |
| TLV7021 | <a href="#">Click here</a> | <a href="#">Click here</a> | <a href="#">Click here</a> | <a href="#">Click here</a> | <a href="#">Click here</a> |
| TLV7012 | <a href="#">Click here</a> | <a href="#">Click here</a> | <a href="#">Click here</a> | <a href="#">Click here</a> | <a href="#">Click here</a> |
| TLV7022 | <a href="#">Click here</a> | <a href="#">Click here</a> | <a href="#">Click here</a> | <a href="#">Click here</a> | <a href="#">Click here</a> |

### 11.3 Receiving Notification of Documentation Updates

To receive notification of documentation updates, navigate to the device product folder on ti.com. In the upper right corner, click on *Alert me* to register and receive a weekly digest of any product information that has changed. For change details, review the revision history included in any revised document.

### 11.4 Community Resources

[TI E2E™ support forums](#) are an engineer's go-to source for fast, verified answers and design help — straight from the experts. Search existing answers or ask your own question to get the quick design help you need.

Linked content is provided "AS IS" by the respective contributors. They do not constitute TI specifications and do not necessarily reflect TI's views; see TI's [Terms of Use](#).

### 11.5 Trademarks

E2E is a trademark of Texas Instruments.

All other trademarks are the property of their respective owners.

### 11.6 Electrostatic Discharge Caution



This integrated circuit can be damaged by ESD. Texas Instruments recommends that all integrated circuits be handled with appropriate precautions. Failure to observe proper handling and installation procedures can cause damage.

ESD damage can range from subtle performance degradation to complete device failure. Precision integrated circuits may be more susceptible to damage because very small parametric changes could cause the device not to meet its published specifications.

### 11.7 Glossary

[SLYZ022](#) — *TI Glossary*.

This glossary lists and explains terms, acronyms, and definitions.

## 12 Mechanical, Packaging, and Orderable Information

The following pages include mechanical, packaging, and orderable information. This information is the most current data available for the designated devices. This data is subject to change without notice and revision of this document. For browser-based versions of this data sheet, refer to the left-hand navigation.

**PACKAGING INFORMATION**

| Orderable Device | Status<br>(1) | Package Type | Package Drawing | Pins | Package Qty | Eco Plan<br>(2) | Lead finish/<br>Ball material<br>(6) | MSL Peak Temp<br>(3) | Op Temp (°C) | Device Marking<br>(4/5) | Samples                 |
|------------------|---------------|--------------|-----------------|------|-------------|-----------------|--------------------------------------|----------------------|--------------|-------------------------|-------------------------|
| TLV7011DBVR      | ACTIVE        | SOT-23       | DBV             | 5    | 3000        | RoHS & Green    | NIPDAUAG                             | Level-1-260C-UNLIM   | -40 to 125   | 11C2                    | <a href="#">Samples</a> |
| TLV7011DCKR      | ACTIVE        | SC70         | DCK             | 5    | 3000        | RoHS & Green    | NIPDAU                               | Level-2-260C-1 YEAR  | -40 to 125   | 19N                     | <a href="#">Samples</a> |
| TLV7011DCKT      | ACTIVE        | SC70         | DCK             | 5    | 250         | RoHS & Green    | NIPDAU                               | Level-2-260C-1 YEAR  | -40 to 125   | 19N                     | <a href="#">Samples</a> |
| TLV7011DPWR      | ACTIVE        | X2SON        | DPW             | 5    | 3000        | RoHS & Green    | NIPDAU                               | Level-1-260C-UNLIM   | -40 to 125   | 7N                      | <a href="#">Samples</a> |
| TLV7012DDFR      | ACTIVE        | SOT-23-THIN  | DDF             | 8    | 3000        | RoHS & Green    | NIPDAU                               | Level-1-260C-UNLIM   | -40 to 125   | 7012                    | <a href="#">Samples</a> |
| TLV7012DGKR      | ACTIVE        | VSSOP        | DGK             | 8    | 2500        | RoHS & Green    | NIPDAUAG   SN                        | Level-1-260C-UNLIM   | -40 to 125   | 7012                    | <a href="#">Samples</a> |
| TLV7012DSGR      | ACTIVE        | WSON         | DSG             | 8    | 3000        | RoHS & Green    | NIPDAU                               | Level-1-260C-UNLIM   | -40 to 125   | 7012                    | <a href="#">Samples</a> |
| TLV7021DBVR      | ACTIVE        | SOT-23       | DBV             | 5    | 3000        | RoHS & Green    | NIPDAUAG                             | Level-1-260C-UNLIM   | -40 to 125   | 11D2                    | <a href="#">Samples</a> |
| TLV7021DCKR      | ACTIVE        | SC70         | DCK             | 5    | 3000        | RoHS & Green    | NIPDAU   SN                          | Level-2-260C-1 YEAR  | -40 to 125   | 19O                     | <a href="#">Samples</a> |
| TLV7021DCKT      | ACTIVE        | SC70         | DCK             | 5    | 250         | RoHS & Green    | NIPDAU   SN                          | Level-2-260C-1 YEAR  | -40 to 125   | 19O                     | <a href="#">Samples</a> |
| TLV7021DPWR      | ACTIVE        | X2SON        | DPW             | 5    | 3000        | RoHS & Green    | NIPDAU                               | Level-1-260C-UNLIM   | -40 to 125   | 7P                      | <a href="#">Samples</a> |
| TLV7022DDFR      | ACTIVE        | SOT-23-THIN  | DDF             | 8    | 3000        | RoHS & Green    | NIPDAU                               | Level-1-260C-UNLIM   | -40 to 125   | 7022                    | <a href="#">Samples</a> |
| TLV7022DGKR      | ACTIVE        | VSSOP        | DGK             | 8    | 2500        | RoHS & Green    | NIPDAUAG   SN                        | Level-1-260C-UNLIM   | -40 to 125   | 7022                    | <a href="#">Samples</a> |
| TLV7022DSGR      | ACTIVE        | WSON         | DSG             | 8    | 3000        | RoHS & Green    | NIPDAU                               | Level-1-260C-UNLIM   | -40 to 125   | 7022                    | <a href="#">Samples</a> |

(1) The marketing status values are defined as follows:

**ACTIVE:** Product device recommended for new designs.

**LIFEBUY:** TI has announced that the device will be discontinued, and a lifetime-buy period is in effect.

**NRND:** Not recommended for new designs. Device is in production to support existing customers, but TI does not recommend using this part in a new design.

**PREVIEW:** Device has been announced but is not in production. Samples may or may not be available.

**OBSELETE:** TI has discontinued the production of the device.

(2) **RoHS:** TI defines "RoHS" to mean semiconductor products that are compliant with the current EU RoHS requirements for all 10 RoHS substances, including the requirement that RoHS substance do not exceed 0.1% by weight in homogeneous materials. Where designed to be soldered at high temperatures, "RoHS" products are suitable for use in specified lead-free processes. TI may reference these types of products as "Pb-Free".

**RoHS Exempt:** TI defines "RoHS Exempt" to mean products that contain lead but are compliant with EU RoHS pursuant to a specific EU RoHS exemption.

**Green:** TI defines "Green" to mean the content of Chlorine (Cl) and Bromine (Br) based flame retardants meet JS709B low halogen requirements of  $\leq 1000$ ppm threshold. Antimony trioxide based flame retardants must also meet the  $\leq 1000$ ppm threshold requirement.

(3) MSL, Peak Temp. - The Moisture Sensitivity Level rating according to the JEDEC industry standard classifications, and peak solder temperature.

(4) There may be additional marking, which relates to the logo, the lot trace code information, or the environmental category on the device.

(5) Multiple Device Markings will be inside parentheses. Only one Device Marking contained in parentheses and separated by a "~" will appear on a device. If a line is indented then it is a continuation of the previous line and the two combined represent the entire Device Marking for that device.

(6) Lead finish/Ball material - Orderable Devices may have multiple material finish options. Finish options are separated by a vertical ruled line. Lead finish/Ball material values may wrap to two lines if the finish value exceeds the maximum column width.

**Important Information and Disclaimer:** The information provided on this page represents TI's knowledge and belief as of the date that it is provided. TI bases its knowledge and belief on information provided by third parties, and makes no representation or warranty as to the accuracy of such information. Efforts are underway to better integrate information from third parties. TI has taken and continues to take reasonable steps to provide representative and accurate information but may not have conducted destructive testing or chemical analysis on incoming materials and chemicals. TI and TI suppliers consider certain information to be proprietary, and thus CAS numbers and other limited information may not be available for release.

In no event shall TI's liability arising out of such information exceed the total purchase price of the TI part(s) at issue in this document sold by TI to Customer on an annual basis.

**TAPE AND REEL INFORMATION**

**QUADRANT ASSIGNMENTS FOR PIN 1 ORIENTATION IN TAPE**

\*All dimensions are nominal

| Device      | Package Type | Package Drawing | Pins | SPQ  | Reel Diameter (mm) | Reel Width W1 (mm) | A0 (mm) | B0 (mm) | K0 (mm) | P1 (mm) | W (mm) | Pin1 Quadrant |
|-------------|--------------|-----------------|------|------|--------------------|--------------------|---------|---------|---------|---------|--------|---------------|
| TLV7011DBVR | SOT-23       | DBV             | 5    | 3000 | 180.0              | 8.4                | 3.23    | 3.17    | 1.37    | 4.0     | 8.0    | Q3            |
| TLV7011DCKR | SC70         | DCK             | 5    | 3000 | 178.0              | 9.0                | 2.4     | 2.5     | 1.2     | 4.0     | 8.0    | Q3            |
| TLV7011DCKT | SC70         | DCK             | 5    | 250  | 178.0              | 9.0                | 2.4     | 2.5     | 1.2     | 4.0     | 8.0    | Q3            |
| TLV7011DPWR | X2SON        | DPW             | 5    | 3000 | 178.0              | 8.4                | 0.91    | 0.91    | 0.5     | 2.0     | 8.0    | Q2            |
| TLV7012DDFR | SOT-23-THIN  | DDF             | 8    | 3000 | 180.0              | 8.4                | 3.2     | 3.2     | 1.4     | 4.0     | 8.0    | Q3            |
| TLV7012DGKR | VSSOP        | DGK             | 8    | 2500 | 330.0              | 12.4               | 5.3     | 3.4     | 1.4     | 8.0     | 12.0   | Q1            |
| TLV7012DSGR | WSON         | DSG             | 8    | 3000 | 180.0              | 8.4                | 2.3     | 2.3     | 1.15    | 4.0     | 8.0    | Q2            |
| TLV7021DBVR | SOT-23       | DBV             | 5    | 3000 | 180.0              | 8.4                | 3.23    | 3.17    | 1.37    | 4.0     | 8.0    | Q3            |
| TLV7021DCKR | SC70         | DCK             | 5    | 3000 | 180.0              | 8.4                | 2.3     | 2.5     | 1.2     | 4.0     | 8.0    | Q3            |
| TLV7021DCKT | SC70         | DCK             | 5    | 250  | 180.0              | 8.4                | 2.3     | 2.5     | 1.2     | 4.0     | 8.0    | Q3            |
| TLV7021DPWR | X2SON        | DPW             | 5    | 3000 | 178.0              | 8.4                | 0.91    | 0.91    | 0.5     | 2.0     | 8.0    | Q2            |
| TLV7022DDFR | SOT-23-THIN  | DDF             | 8    | 3000 | 180.0              | 8.4                | 3.2     | 3.2     | 1.4     | 4.0     | 8.0    | Q3            |
| TLV7022DGKR | VSSOP        | DGK             | 8    | 2500 | 330.0              | 12.4               | 5.3     | 3.4     | 1.4     | 8.0     | 12.0   | Q1            |
| TLV7022DSGR | WSON         | DSG             | 8    | 3000 | 180.0              | 8.4                | 2.3     | 2.3     | 1.15    | 4.0     | 8.0    | Q2            |

**TAPE AND REEL BOX DIMENSIONS**

\*All dimensions are nominal

| Device      | Package Type | Package Drawing | Pins | SPQ  | Length (mm) | Width (mm) | Height (mm) |
|-------------|--------------|-----------------|------|------|-------------|------------|-------------|
| TLV7011DBVR | SOT-23       | DBV             | 5    | 3000 | 183.0       | 183.0      | 20.0        |
| TLV7011DCKR | SC70         | DCK             | 5    | 3000 | 190.0       | 190.0      | 30.0        |
| TLV7011DCKT | SC70         | DCK             | 5    | 250  | 190.0       | 190.0      | 30.0        |
| TLV7011DPWR | X2SON        | DPW             | 5    | 3000 | 205.0       | 200.0      | 33.0        |
| TLV7012DDFR | SOT-23-THIN  | DDF             | 8    | 3000 | 210.0       | 185.0      | 35.0        |
| TLV7012DGKR | VSSOP        | DGK             | 8    | 2500 | 366.0       | 364.0      | 50.0        |
| TLV7012DSGR | WSON         | DSG             | 8    | 3000 | 210.0       | 185.0      | 35.0        |
| TLV7021DBVR | SOT-23       | DBV             | 5    | 3000 | 183.0       | 183.0      | 20.0        |
| TLV7021DCKR | SC70         | DCK             | 5    | 3000 | 210.0       | 185.0      | 35.0        |
| TLV7021DCKT | SC70         | DCK             | 5    | 250  | 210.0       | 185.0      | 35.0        |
| TLV7021DPWR | X2SON        | DPW             | 5    | 3000 | 205.0       | 200.0      | 33.0        |
| TLV7022DDFR | SOT-23-THIN  | DDF             | 8    | 3000 | 210.0       | 185.0      | 35.0        |
| TLV7022DGKR | VSSOP        | DGK             | 8    | 2500 | 366.0       | 364.0      | 50.0        |
| TLV7022DSGR | WSON         | DSG             | 8    | 3000 | 210.0       | 185.0      | 35.0        |

## GENERIC PACKAGE VIEW

DPW 5

X2SON - 0.4 mm max height

PLASTIC SMALL OUTLINE - NO LEAD



Images above are just a representation of the package family, actual package may vary.  
Refer to the product data sheet for package details.

4211218-3/D

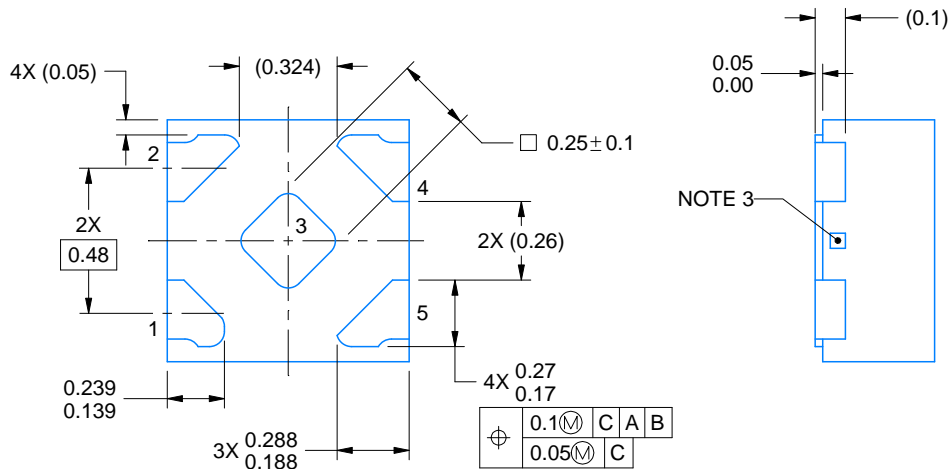
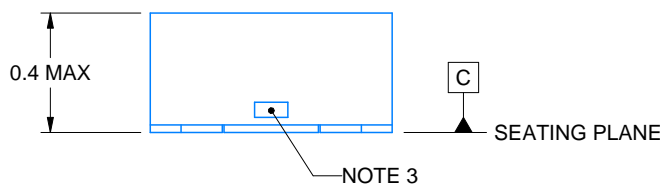
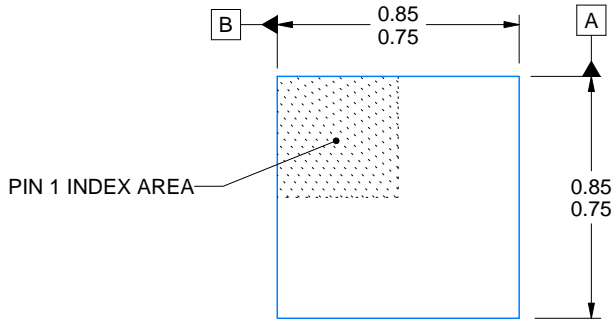

4223102/D 03/2022

NOTES:

1. All linear dimensions are in millimeters. Any dimensions in parenthesis are for reference only. Dimensioning and tolerancing per ASME Y14.5M.
2. This drawing is subject to change without notice.
3. The size and shape of this feature may vary.

# EXAMPLE BOARD LAYOUT

DPW0005A

X2SON - 0.4 mm max height

PLASTIC SMALL OUTLINE - NO LEAD



LAND PATTERN EXAMPLE  
SOLDER MASK DEFINED  
SCALE:60X

4223102/D 03/2022

NOTES: (continued)

4. This package is designed to be soldered to a thermal pad on the board. For more information, refer to QFN/SON PCB application note in literature No. SLUA271 ([www.ti.com/lit/sl原因271](http://www.ti.com/lit/sl原因271)).



# EXAMPLE STENCIL DESIGN

DPW0005A

X2SON - 0.4 mm max height

PLASTIC SMALL OUTLINE - NO LEAD



SOLDER PASTE EXAMPLE  
BASED ON 0.1 mm THICK STENCIL

EXPOSED PAD 3  
92% PRINTED SOLDER COVERAGE BY AREA UNDER PACKAGE  
SCALE:100X

4223102/D 03/2022

NOTES: (continued)

5. Laser cutting apertures with trapezoidal walls and rounded corners may offer better paste release. IPC-7525 may have alternate design recommendations.



# EXAMPLE BOARD LAYOUT

DBV0005A

SOT-23 - 1.45 mm max height

SMALL OUTLINE TRANSISTOR



LAND PATTERN EXAMPLE  
EXPOSED METAL SHOWN  
SCALE:15X



SOLDER MASK DETAILS

4214839/J 02/2024

NOTES: (continued)

- 6. Publication IPC-7351 may have alternate designs.
- 7. Solder mask tolerances between and around signal pads can vary based on board fabrication site.

# EXAMPLE STENCIL DESIGN

DBV0005A

SOT-23 - 1.45 mm max height

SMALL OUTLINE TRANSISTOR



SOLDER PASTE EXAMPLE  
BASED ON 0.125 mm THICK STENCIL  
SCALE:15X

4214839/J 02/2024

NOTES: (continued)

8. Laser cutting apertures with trapezoidal walls and rounded corners may offer better paste release. IPC-7525 may have alternate design recommendations.
9. Board assembly site may have different recommendations for stencil design.

# DCK0005A



# PACKAGE OUTLINE

SOT - 1.1 max height

SMALL OUTLINE TRANSISTOR



4214834/D 07/2023

## NOTES:

1. All linear dimensions are in millimeters. Any dimensions in parenthesis are for reference only. Dimensioning and tolerancing per ASME Y14.5M.
2. This drawing is subject to change without notice.
3. Reference JEDEC MO-203.
4. Support pin may differ or may not be present.
5. Lead width does not comply with JEDEC.

# EXAMPLE BOARD LAYOUT

DCK0005A

SOT - 1.1 max height

SMALL OUTLINE TRANSISTOR



LAND PATTERN EXAMPLE  
EXPOSED METAL SHOWN  
SCALE:18X

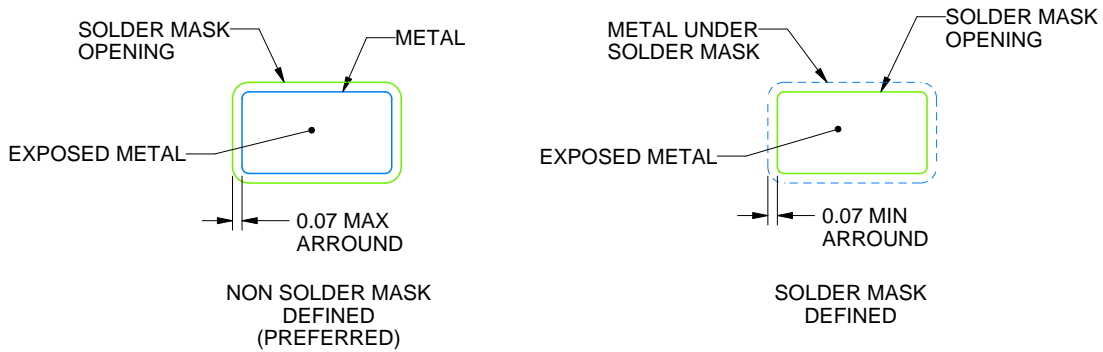

SOLDER MASK DETAILS

4214834/D 07/2023

NOTES: (continued)

- 6. Publication IPC-7351 may have alternate designs.
- 7. Solder mask tolerances between and around signal pads can vary based on board fabrication site.

# EXAMPLE STENCIL DESIGN

DCK0005A

SOT - 1.1 max height

SMALL OUTLINE TRANSISTOR

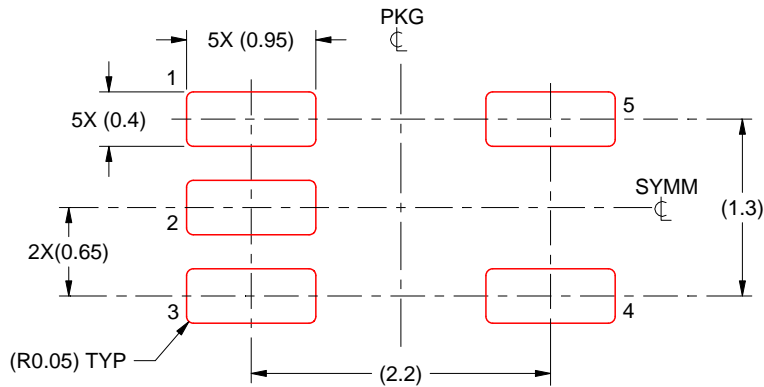

SOLDER PASTE EXAMPLE  
BASED ON 0.125 THICK STENCIL  
SCALE:18X

4214834/D 07/2023

NOTES: (continued)

8. Laser cutting apertures with trapezoidal walls and rounded corners may offer better paste release. IPC-7525 may have alternate design recommendations.
9. Board assembly site may have different recommendations for stencil design.

DGK (S-PDSO-G8)

PLASTIC SMALL-OUTLINE PACKAGE



- NOTES:
- A. All linear dimensions are in millimeters.
  - B. This drawing is subject to change without notice.
  - C. Body length does not include mold flash, protrusions, or gate burrs. Mold flash, protrusions, or gate burrs shall not exceed 0.15 per end.
  - D. Body width does not include interlead flash. Interlead flash shall not exceed 0.50 per side.
  - E. Falls within JEDEC MO-187 variation AA, except interlead flash.



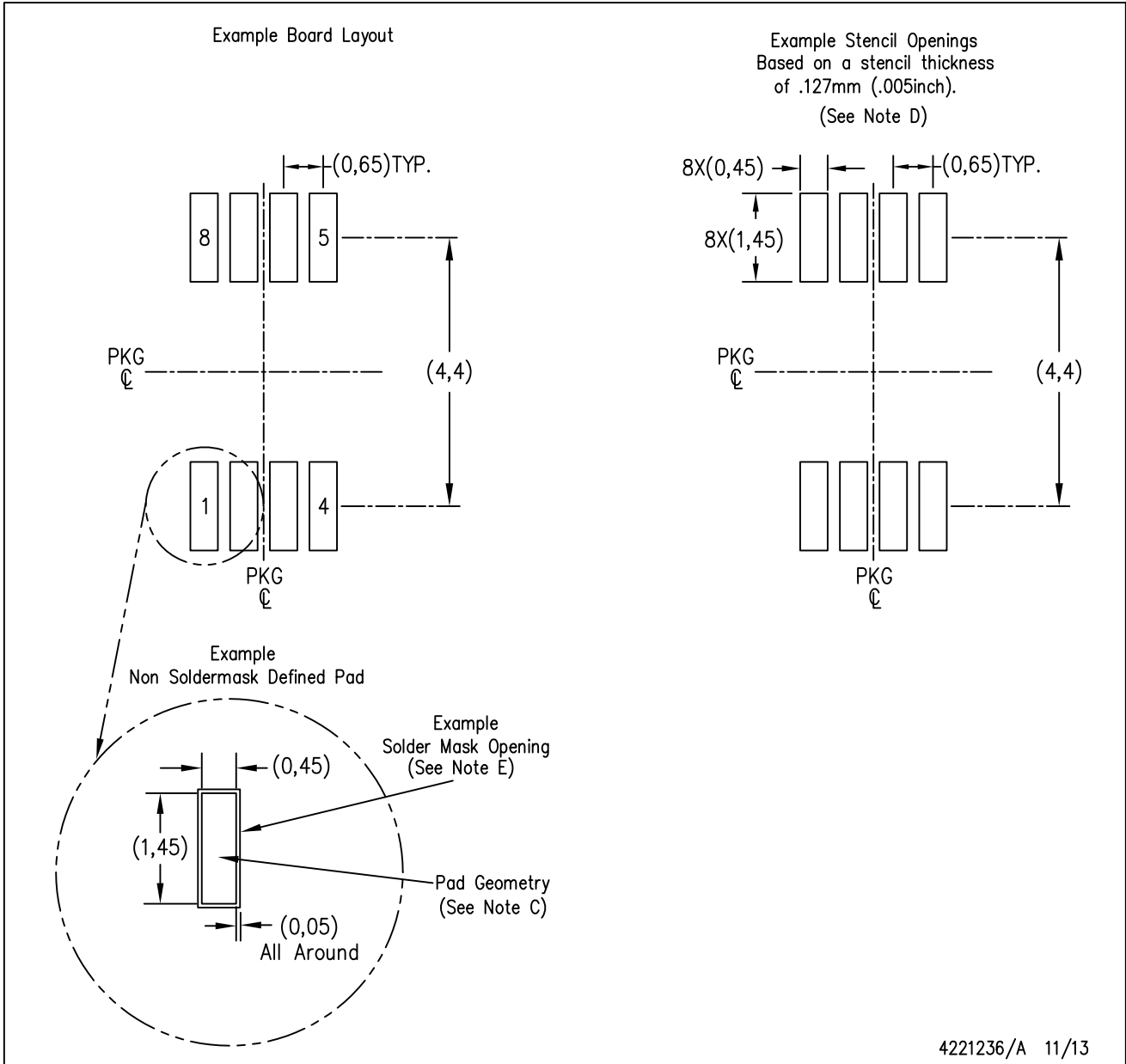

- NOTES:
- A. All linear dimensions are in millimeters.
  - B. This drawing is subject to change without notice.
  - C. Publication IPC-7351 is recommended for alternate designs.
  - D. Laser cutting apertures with trapezoidal walls and also rounding corners will offer better paste release. Customers should contact their board assembly site for stencil design recommendations. Refer to IPC-7525 for other stencil recommendations.
  - E. Customers should contact their board fabrication site for solder mask tolerances between and around signal pads.

## GENERIC PACKAGE VIEW

**DSG 8**

**WSON - 0.8 mm max height**

2 x 2, 0.5 mm pitch

PLASTIC SMALL OUTLINE - NO LEAD

This image is a representation of the package family, actual package may vary.  
Refer to the product data sheet for package details.



4224783/A



ALTERNATIVE TERMINAL SHAPE TYPICAL



| SIDE WALL METAL THICKNESS DIM A |          |
|---------------------------------|----------|
| OPTION 1                        | OPTION 2 |
| 0.1                             | 0.2      |

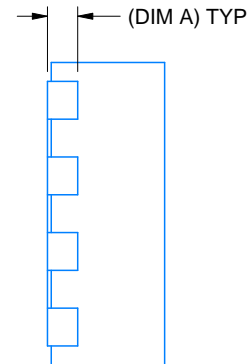

4218900/E 08/2022

NOTES:

1. All linear dimensions are in millimeters. Any dimensions in parenthesis are for reference only. Dimensioning and tolerancing per ASME Y14.5M.
2. This drawing is subject to change without notice.
3. The package thermal pad must be soldered to the printed circuit board for thermal and mechanical performance.

# EXAMPLE BOARD LAYOUT

DSG0008A

WSON - 0.8 mm max height

PLASTIC SMALL OUTLINE - NO LEAD



LAND PATTERN EXAMPLE  
SCALE:20X



SOLDER MASK DETAILS

4218900/E 08/2022

NOTES: (continued)

4. This package is designed to be soldered to a thermal pad on the board. For more information, see Texas Instruments literature number SLUA271 ([www.ti.com/lit/slua271](http://www.ti.com/lit/slua271)).
5. Vias are optional depending on application, refer to device data sheet. If any vias are implemented, refer to their locations shown on this view. It is recommended that vias under paste be filled, plugged or tented.

# EXAMPLE STENCIL DESIGN

DSG0008A

WSON - 0.8 mm max height

PLASTIC SMALL OUTLINE - NO LEAD



SOLDER PASTE EXAMPLE  
BASED ON 0.125 mm THICK STENCIL

EXPOSED PAD 9:  
87% PRINTED SOLDER COVERAGE BY AREA UNDER PACKAGE  
SCALE:25X

4218900/E 08/2022

NOTES: (continued)

6. Laser cutting apertures with trapezoidal walls and rounded corners may offer better paste release. IPC-7525 may have alternate design recommendations.

# DDF0008A



# PACKAGE OUTLINE

## SOT-23 - 1.1 mm max height

PLASTIC SMALL OUTLINE



4222047/C 10/2022

### NOTES:

1. All linear dimensions are in millimeters. Any dimensions in parenthesis are for reference only. Dimensioning and tolerancing per ASME Y14.5M.
2. This drawing is subject to change without notice.
3. This dimension does not include mold flash, protrusions, or gate burrs. Mold flash, protrusions, or gate burrs shall not exceed 0.15 mm per side.

# EXAMPLE BOARD LAYOUT

DDF0008A

SOT-23 - 1.1 mm max height

PLASTIC SMALL OUTLINE



LAND PATTERN EXAMPLE  
SCALE:15X

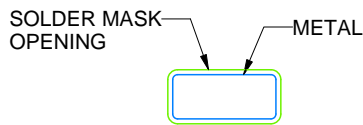

NON SOLDER MASK  
DEFINED

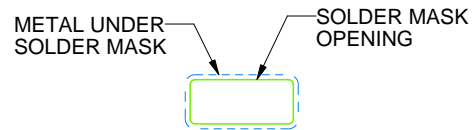

SOLDER MASK  
DEFINED

## SOLDER MASK DETAILS

4222047/C 10/2022

NOTES: (continued)

4. Publication IPC-7351 may have alternate designs.
5. Solder mask tolerances between and around signal pads can vary based on board fabrication site.

# EXAMPLE STENCIL DESIGN

DDF0008A

SOT-23 - 1.1 mm max height

PLASTIC SMALL OUTLINE



SOLDER PASTE EXAMPLE  
BASED ON 0.125 mm THICK STENCIL  
SCALE:15X

4222047/C 10/2022

NOTES: (continued)

6. Laser cutting apertures with trapezoidal walls and rounded corners may offer better paste release. IPC-7525 may have alternate design recommendations.
7. Board assembly site may have different recommendations for stencil design.



## IMPORTANT NOTICE AND DISCLAIMER

TI PROVIDES TECHNICAL AND RELIABILITY DATA (INCLUDING DATA SHEETS), DESIGN RESOURCES (INCLUDING REFERENCE DESIGNS), APPLICATION OR OTHER DESIGN ADVICE, WEB TOOLS, SAFETY INFORMATION, AND OTHER RESOURCES "AS IS" AND WITH ALL FAULTS, AND DISCLAIMS ALL WARRANTIES, EXPRESS AND IMPLIED, INCLUDING WITHOUT LIMITATION ANY IMPLIED WARRANTIES OF MERCHANTABILITY, FITNESS FOR A PARTICULAR PURPOSE OR NON-INFRINGEMENT OF THIRD PARTY INTELLECTUAL PROPERTY RIGHTS.

These resources are intended for skilled developers designing with TI products. You are solely responsible for (1) selecting the appropriate TI products for your application, (2) designing, validating and testing your application, and (3) ensuring your application meets applicable standards, and any other safety, security, regulatory or other requirements.

These resources are subject to change without notice. TI grants you permission to use these resources only for development of an application that uses the TI products described in the resource. Other reproduction and display of these resources is prohibited. No license is granted to any other TI intellectual property right or to any third party intellectual property right. TI disclaims responsibility for, and you will fully indemnify TI and its representatives against, any claims, damages, costs, losses, and liabilities arising out of your use of these resources.

TI's products are provided subject to [TI's Terms of Sale](#) or other applicable terms available either on [ti.com](https://www.ti.com) or provided in conjunction with such TI products. TI's provision of these resources does not expand or otherwise alter TI's applicable warranties or warranty disclaimers for TI products.

TI objects to and rejects any additional or different terms you may have proposed.

Mailing Address: Texas Instruments, Post Office Box 655303, Dallas, Texas 75265  
Copyright © 2024, Texas Instruments Incorporated

单击下面可查看定价，库存，交付和生命周期等信息

[>>TI\(德州仪器\)](#)