



Industrial, 14kSPS, 24-Bit Analog-to-Digital Converter with Low-Drift Reference

Check for Samples: [ADS1259](#)

FEATURES

- **24 Bits, No Missing Codes**
- **Output Data Rates From 10 To 14kSPS**
- **High Performance:**
 - **INL: 0.4ppm**
 - **Reference Drift: 2ppm/°C**
 - **Gain Drift: 0.5ppm/°C**
 - **Offset Drift: 0.05μV/°C**
 - **Noise: 0.7μV_{RMS} at 60SPS**
- **Simultaneous 50/60Hz Rejection at 10SPS**
- **Single-Cycle Settling**
- **Internal Oscillator**
- **Out-of-Range Detection**
- **Readback Data Integrity by Checksum and Redundant Data Read Capability**
- **SPI™-Compatible Interface**
- **Analog Supply: +5V or ±2.5V**
- **Digital Supply: +2.7V to +5V**
- **Low Power: 13mW**

APPLICATIONS

- **Industrial Process Control**
- **Scientific Instrumentation**
- **Test and Measurement**

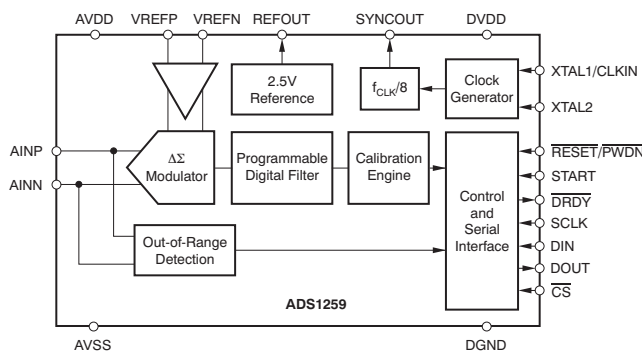

DESCRIPTION

The ADS1259 is a high-linearity, low-drift, 24-bit, analog-to-digital converter (ADC) designed for the needs of industrial process control, precision instrumentation, and other exacting applications. Combined with a signal amplifier (such as the [PGA280](#)), a high-resolution, high-accuracy measurement system is formed that is capable of digitizing a wide range of signals.

The converter uses a fourth-order, inherently stable, delta-sigma ($\Delta\Sigma$) modulator that provides outstanding noise and linearity performance. The data rates are programmable up to 14kSPS including 10SPS, 50SPS, and 60SPS that provide excellent normal mode line-cycle rejection. The digital filter can be programmed for a fast settling mode where the conversions settle in a single cycle, or programmed for a high line-cycle rejection mode. A fast responding input over-range detector flags the conversion data if an input over-range should occur.

The ADS1259 also provides an integrated low-noise, very low drift 2.5V reference. The on-chip oscillator, an external crystal, or an external clock can be used as the ADC clock source.

Data and control communication are handled over a 4MHz, SPI-compatible interface capable of operating with a minimum of three wires. Data integrity is augmented by data bytes checksum and redundant data read capability. Conversions are synchronized either by command or by pin.

Dissipating only 13mW in operation, the ADS1259 can be powered down, dissipating less than 25μW. The ADS1259 is offered in a TSSOP-20 package and is fully specified from -40°C to +105°C.

RELATED PRODUCTS

FEATURES	PRODUCT
24-bit ADC with integrated PGA	ADS1256
Wide-range PGA	PGA280
High-precision PGA; G = 1, 10, 100, 1000	PGA204



Please be aware that an important notice concerning availability, standard warranty, and use in critical applications of Texas Instruments semiconductor products and disclaimers thereto appears at the end of this data sheet.

SPI is a trademark of Motorola.

All other trademarks are the property of their respective owners.

PRODUCTION DATA information is current as of publication date. Products conform to specifications per the terms of the Texas Instruments standard warranty. Production processing does not necessarily include testing of all parameters.

Copyright © 2009–2011, Texas Instruments Incorporated



This integrated circuit can be damaged by ESD. Texas Instruments recommends that all integrated circuits be handled with appropriate precautions. Failure to observe proper handling and installation procedures can cause damage.

ESD damage can range from subtle performance degradation to complete device failure. Precision integrated circuits may be more susceptible to damage because very small parametric changes could cause the device not to meet its published specifications.

ORDERING INFORMATION

For the most current package and ordering information see the Package Option Addendum at the end of this document, or see the TI web site at www.ti.com.

ABSOLUTE MAXIMUM RATINGS⁽¹⁾

Over operating free-air temperature range, unless otherwise noted.

	ADS1259		UNIT
	MIN	MAX	
AVDD to AVSS	-0.3	+5.5	V
AVSS to DGND	-2.8	+0.3	V
DVDD to DGND	-0.3	+5.5	V
Input current, momentary	-100	+100	mA
Input current, continuous	-10	+10	mA
Analog input voltage to DGND	AVSS - 0.3	AVDD + 0.3	V
Digital input voltage to DGND	-0.3	DVDD + 0.3	V
Maximum junction temperature		+150	°C
Operating temperature range	-40	+125	°C
Storage temperature range	-60	+150	°C

- (1) Stresses above these ratings may cause permanent damage. Exposure to absolute maximum conditions for extended periods may degrade device reliability. These are stress ratings only, and functional operation of the device at these or any other conditions beyond those specified is not implied.

ELECTRICAL CHARACTERISTICS

Minimum/maximum specifications are at $T_A = -40^\circ\text{C}$ to $+105^\circ\text{C}$. Typical specifications are at $T_A = +25^\circ\text{C}$, $AVDD = +2.5\text{V}$, $AVSS = -2.5\text{V}$, $DVDD = +3.3\text{V}$, $f_{\text{CLK}} = 7.3728\text{MHz}$, $V_{\text{REF}} = 2.5\text{V}$, and $f_{\text{DATA}} = 60\text{SPS}$, unless otherwise noted.

PARAMETER	TEST CONDITIONS	ADS1259			ADS1259B			UNIT
		MIN	TYP	MAX	MIN	TYP	MAX	
ANALOG INPUTS								
Full-scale input voltage range (FSR)	$V_{\text{IN}} = (\text{AINP} - \text{AINN})$		$\pm V_{\text{REF}}$			$\pm V_{\text{REF}}$		V
Absolute input voltage (AINP, AINN to DGND)		$AVSS - 0.1$		$AVDD + 0.1$	$AVSS - 0.1$		$AVDD + 0.1$	V
Differential input impedance			120			120		k Ω
Common-mode input impedance			500			500		k Ω
SYSTEM PERFORMANCE								
Resolution	No missing codes	24			24			Bits
Data rate (f_{DATA})		10		14400	10		14400	SPS ⁽¹⁾
Integral nonlinearity	Best fit method		± 0.0003	± 0.001		± 0.00004 ⁽²⁾	± 0.0003	%FSR
Offset error			± 40	± 250		± 40	± 250	μV
Offset error after calibration ⁽³⁾			± 1			± 1		μV
Offset drift ⁽⁴⁾	$T_A = -40^\circ\text{C}$ to $+105^\circ\text{C}$		0.05	0.25		0.05	0.25	$\mu\text{V}/^\circ\text{C}$
Gain error ⁽⁵⁾			± 0.05	± 0.5		± 0.05	± 0.5	%
Gain error after calibration ⁽³⁾			± 0.0002			± 0.0002		%
Gain drift ⁽⁴⁾	$T_A = -40^\circ\text{C}$ to $+105^\circ\text{C}$		0.5	2.5		0.5	2.5	ppm/ $^\circ\text{C}$
Normal mode rejection	See Figure 42							
Common-mode rejection	60Hz, ac ⁽⁶⁾	100	120		100	120		dB
Noise	See Table 1		0.7			0.7		μV
AVDD, AVSS power-supply rejection	60Hz, ac ⁽⁶⁾	85	95		85	95		dB
DVDD power-supply rejection	60Hz, ac ⁽⁶⁾	85	110		85	110		dB
OUT-OF-RANGE DETECTION								
Threshold ⁽⁷⁾	Level		± 105			± 105		%FSR
	Accuracy		± 0.5			± 0.5		%FSR
VOLTAGE REFERENCE INPUTS								
Reference input range (V_{REF})	$V_{\text{REF}} = (\text{VREFP} - \text{VREFN})$	0.5	2.5	$AVDD - AVSS + 200\text{mV}$	0.5	2.5	$AVDD - AVSS + 200\text{mV}$	V
Negative reference absolute input (VREFN to DGND)		$AVSS - 100\text{mV}$		$V_{\text{REFP}} - 0.5$	$AVSS - 100\text{mV}$		$V_{\text{REFP}} - 0.5$	V
Positive reference absolute input (VREFP to DGND)		$V_{\text{REFN}} + 0.5$		$AVDD + 100\text{mV}$	$V_{\text{REFN}} + 0.5$		$AVDD + 100\text{mV}$	V
Average reference input current ⁽⁸⁾			$200\text{nA} + 60\text{nA/V}$			$200\text{nA} + 60\text{nA/V}$		
Average reference input current drift	Internal or external clock		0.2			0.2		nA/ $^\circ\text{C}$
INTERNAL VOLTAGE REFERENCE								
Reference output voltage	$V_{\text{REFOUT}} = (\text{REFOUT} - \text{AVSS})$		2.5			2.5		V
Accuracy	$T_A = +25^\circ\text{C}$			± 0.4			± 0.2	%
Temperature drift ⁽⁴⁾	$T_A = -40^\circ\text{C}$ to $+105^\circ\text{C}$		10	40		4	12	ppm/ $^\circ\text{C}$
	$T_A = 0^\circ\text{C}$ to $+85^\circ\text{C}$					2	5	ppm/ $^\circ\text{C}$
Drive current sink and source		-10		10	-10		10	mA ⁽⁹⁾
Load regulation			10			10		$\mu\text{V}/\text{mA}$
Turn-on settling time ⁽¹⁰⁾	$\pm 0.001\%$ settling		1			1		s
Long-term stability	0 to 1000 hours		70			70		ppm/1000hr
Thermal hysteresis ⁽¹¹⁾			30			30		ppm

- (1) SPS = samples per second.
- (2) Shaded cells indicate improved specifications of the ADS1259B.
- (3) Calibration accuracy is on the level of noise (signal and ADC), reduced by the effect of 16 reading averaging.
- (4) Reference drift specified by design and final production test. Drift calculated over the specified temperature range using box method.
- (5) Excludes internal reference error.
- (6) $f_{\text{DATA}} = 14.4\text{kSPS}$. Placing a notch of the digital filter at 60Hz (setting $f_{\text{DATA}} = 10\text{SPS}$ or 60SPS) further improves the common-mode rejection and power-supply rejection of this input frequency.
- (7) Absolute input voltage range for out-of-range specification: $AVSS + 150\text{mV} \leq \text{AINP}$ or $\text{AINN} \leq AVDD - 150\text{mV}$.
- (8) Over the range: $AVSS \leq V_{\text{REFP}}$ or $V_{\text{REFN}} \leq AVDD$. For reference voltage exceeding $AVDD$ or $AVSS$, input current = $150\text{nA}/10\text{mV}$.
- (9) Limit the reference output current to $\pm 10\text{mA}$.
- (10) $C_{\text{REFOUT}} = 1\mu\text{F}$, $C_{\text{REFIN}} = 1\mu\text{F}$.
- (11) See the [Thermal Hysteresis](#) section.

ELECTRICAL CHARACTERISTICS (continued)

Minimum/maximum specifications are at $T_A = -40^{\circ}\text{C}$ to $+105^{\circ}\text{C}$. Typical specifications are at $T_A = +25^{\circ}\text{C}$, $\text{AVDD} = +2.5\text{V}$, $\text{AVSS} = -2.5\text{V}$, $\text{DVDD} = +3.3\text{V}$, $f_{\text{CLK}} = 7.3728\text{MHz}$, $V_{\text{REF}} = 2.5\text{V}$, and $f_{\text{DATA}} = 60\text{SPS}$, unless otherwise noted.

PARAMETER	TEST CONDITIONS	ADS1259			ADS1259B			UNIT
		MIN	TYP	MAX	MIN	TYP	MAX	
CLOCK SOURCE (f_{CLK})								
Internal oscillator	Nominal frequency		7.3728			7.3728		MHz
	Accuracy		± 0.2	± 2		± 0.2	± 2	%
Crystal oscillator	Frequency range	2	7.3728	8	2	7.3728	8	MHz
	Start-up time ⁽¹²⁾		20			20		ms
External clock	Frequency range	0.1	7.3728	8	0.1	7.3728	8	MHz
	Duty cycle	40		60	40		60	%
DIGITAL INPUT/OUTPUT (DVDD = 2.7V to 5.25V)								
V_{IH}		0.8 DVDD		DVDD	0.8 DVDD		DVDD	V
V_{IL}		DGND		0.2 DVDD	DGND		0.2 DVDD	V
V_{OH}	$I_{\text{OH}} = 1\text{mA}$	0.8 DVDD			0.8 DVDD			V
	$I_{\text{OH}} = 8\text{mA}$		0.75 DVDD			0.75 DVDD		V
V_{OL}	$I_{\text{OL}} = 1\text{mA}$			0.2 DVDD			0.2 DVDD	V
	$I_{\text{OL}} = 8\text{mA}$		0.2 DVDD			0.2 DVDD		V
Input hysteresis			0.1			0.1		V
Input leakage	$0 < V_{\text{DIGITAL INPUT}} < \text{DVDD}$			± 10			± 10	μA
POWER SUPPLY								
AVSS		-2.6		0	-2.6		0	V
AVDD		AVSS + 4.75		AVSS + 5.25	AVSS + 4.75		AVSS + 5.25	V
DVDD		2.7		5.25	2.7		5.25	V
AVDD, AVSS current	Operating (reference enabled)		2.3	3.8		2.3	3.8	mA
	Sleep mode (reference enabled)		200			200		μA
	Sleep mode (reference disabled)		1	40		1	40	μA
	Power-Down mode		1	40		1	40	μA
DVDD current ⁽¹³⁾	Operating		500	700		500	700	μA
	Sleep mode		160	300		160	300	μA
	Power-Down mode ⁽¹⁴⁾		1	10		1	10	μA
Power dissipation	Operating		13	22		13	22	mW
	Sleep mode (reference enabled)		1.5			1.5		mW
	Sleep mode (reference disabled)		0.5	1.2		0.5	1.2	mW
	Power-Down mode		10	240		10	240	μW
TEMPERATURE RANGE								
Specified temperature range		-40		+105	-40		+105	$^{\circ}\text{C}$
Operating temperature range		-40		+125	-40		+125	$^{\circ}\text{C}$
Storage temperature range		-60		+150	-60		+150	$^{\circ}\text{C}$

(12) Crystal operation using 18pF load capacitors.

(13) Specified with internal oscillator operating (internal oscillator current: 40 μA , typ).

(14) External CLKIN, SCLK stopped. Digital inputs maintained at V_{IH} or V_{IL} voltage levels.

PIN CONFIGURATION

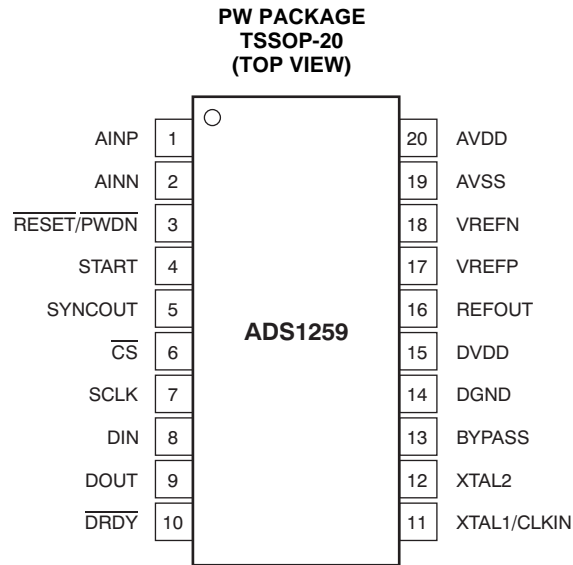

ADS1259 Terminal Functions

PIN NAME	PIN #	FUNCTION	DESCRIPTION
AINP	1	Analog input	Positive analog input
AINN	2	Analog input	Negative analog input
RESET/PWDN	3	Digital input	Reset/Power-Down; reset is active low; hold low for power-down
START	4	Digital input	Start conversions, active high
SYNCOUT	5	Digital output	Sync clock output ($f_{CLK}/8$)
CS	6	Digital input	SPI chip-select, active low
SCLK	7	Digital input	SPI clock input
DIN	8	Digital input	SPI data input
DOUT	9	Digital output	SPI data output
DRDY	10	Digital output	Data ready output, active low
XTAL1/CLKIN	11	Digital input	Internal oscillator: DGND External clock: clock input Crystal oscillator: external crystal1
XTAL2	12	Digital	External crystal2, otherwise no connection
BYPASS	13	Analog	Core voltage bypass
DGND	14	Digital	Digital ground
DVDD	15	Digital	Digital power supply
REFOUT	16	Analog output	Positive reference output
VREFP	17	Analog input	Positive reference input
VREFN	18	Analog input	Negative reference input
AVSS	19	Analog	Negative analog power supply and negative reference output
AVDD	20	Analog	Positive analog power supply

SPI TIMING CHARACTERISTICS

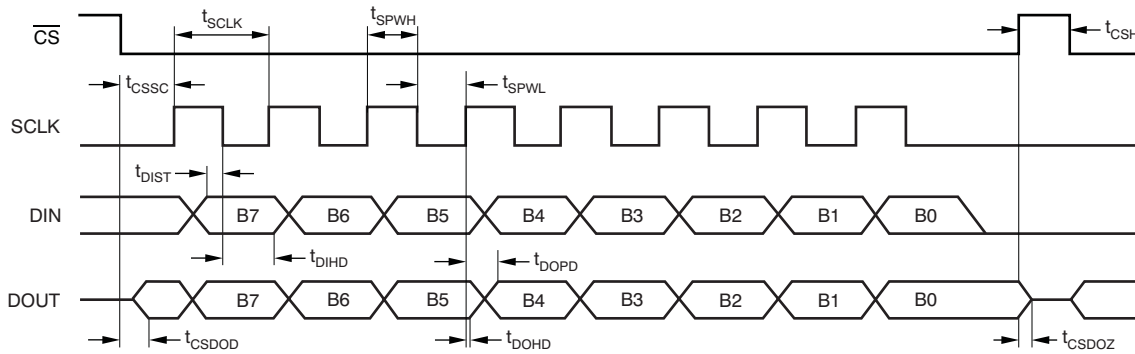

Figure 1. Serial Interface Timing

TIMING REQUIREMENTS: SERIAL INTERFACE TIMING

At $T_A = -40^\circ\text{C}$ to $+105^\circ\text{C}$ and $DV_{DD} = 2.7\text{V}$ to 5.25V , unless otherwise noted.

SYMBOL	DESCRIPTION	MIN	MAX	UNIT
t_{CSSC}	\overline{CS} low to first SCLK: setup time ⁽¹⁾	50		ns
t_{SCLK}	SCLK period	1.8		t_{CLK} ⁽²⁾
t_{SPWH}	SCLK pulse width: high	90		ns
t_{SPWL}	SCLK pulse width: low ⁽³⁾	90		ns
			2^{16}	t_{CLK}
t_{DIST}	Valid DIN to SCLK falling edge: setup time	35		ns
t_{DIHD}	Valid DIN to SCLK falling edge: hold time	20		ns
t_{DOPD}	SCLK rising edge to valid new DOUT: propagation delay ⁽⁴⁾		60	ns
t_{DOHD}	SCLK rising edge to DOUT invalid: hold time	0		ns
t_{CSDOD}	\overline{CS} low to DOUT driven: propagation delay ⁽⁴⁾	0	40	ns
t_{CSDOZ}	\overline{CS} high to DOUT Hi-Z: propagation delay		20	ns
t_{CSH}	\overline{CS} high pulse	20		t_{CLK}

- (1) \overline{CS} can be tied low.
- (2) $t_{CLK} = 1/f_{CLK}$.
- (3) Holding SCLK low longer than $2^{16} \times t_{CLK}$ cycles resets the SPI interface (enabled by SPI register bit).
- (4) DOUT load = $20\text{pF} \parallel 100\text{k}\Omega$ to DGND.

TYPICAL CHARACTERISTICS

At $T_A = +25^\circ\text{C}$, $AVDD = +2.5\text{V}$, $AVSS = -2.5\text{V}$, $DVDD = 3.3\text{V}$, $V_{REF} = 2.5\text{V}$, $V_{REFN} = AVSS$, $f_{CLK} = 7.3728\text{MHz}$, and $f_{DATA} = 60\text{SPS}$, unless otherwise noted.

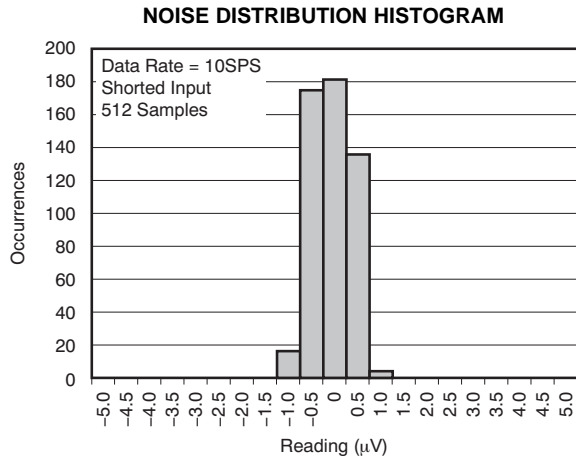

Figure 2.

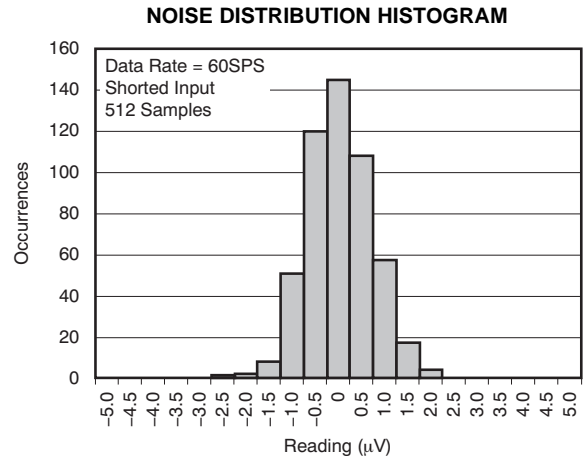

Figure 3.

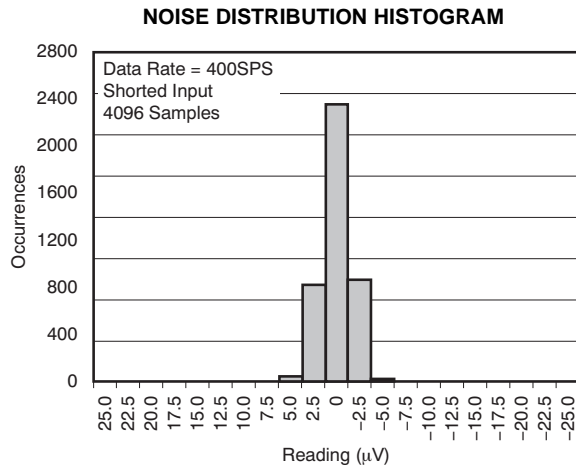

Figure 4.

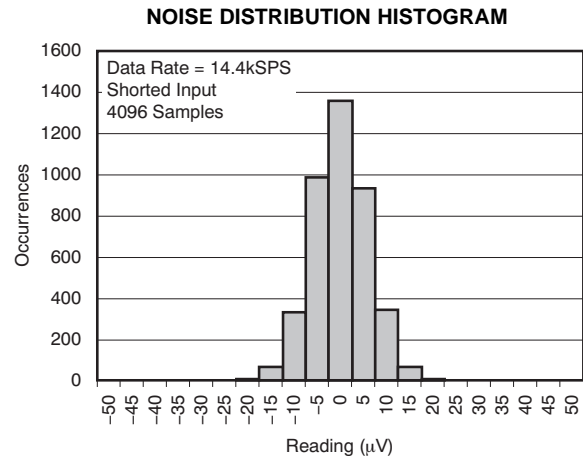

Figure 5.

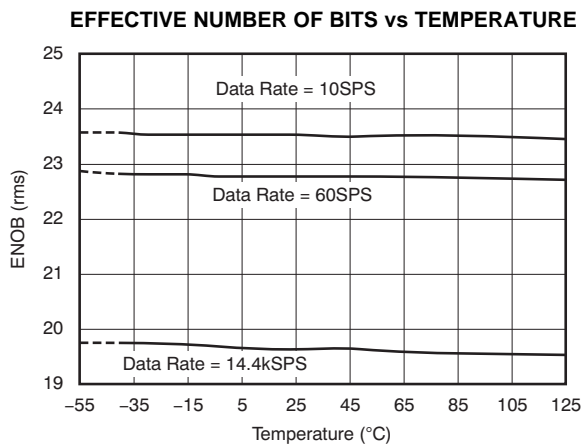

Figure 6.

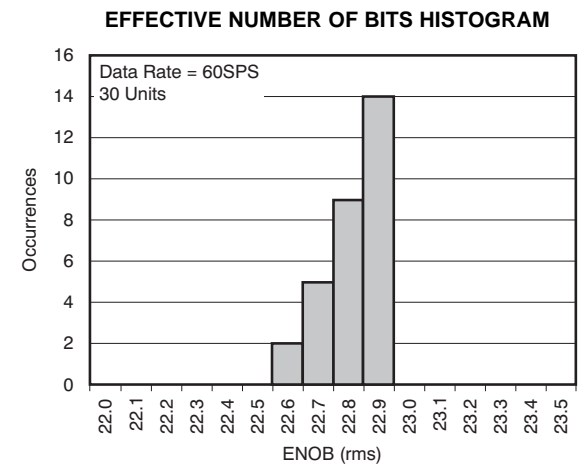

Figure 7.

TYPICAL CHARACTERISTICS (continued)

At $T_A = +25^\circ\text{C}$, $AV_{DD} = +2.5\text{V}$, $AV_{SS} = -2.5\text{V}$, $DV_{DD} = 3.3\text{V}$, $V_{REF} = 2.5\text{V}$, $V_{REFN} = AV_{SS}$, $f_{CLK} = 7.3728\text{MHz}$, and $f_{DATA} = 60\text{SPS}$, unless otherwise noted.

NOISE vs INPUT VOLTAGE

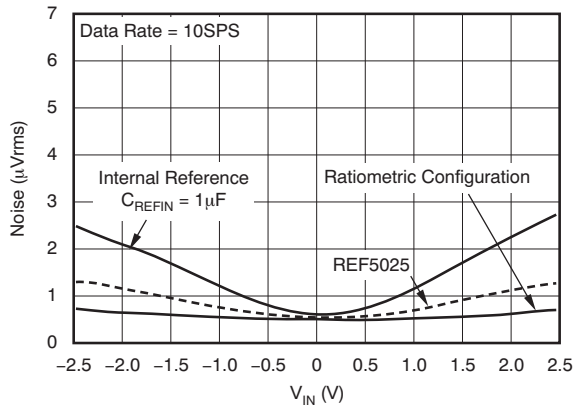

Figure 8.

NOISE vs INPUT VOLTAGE

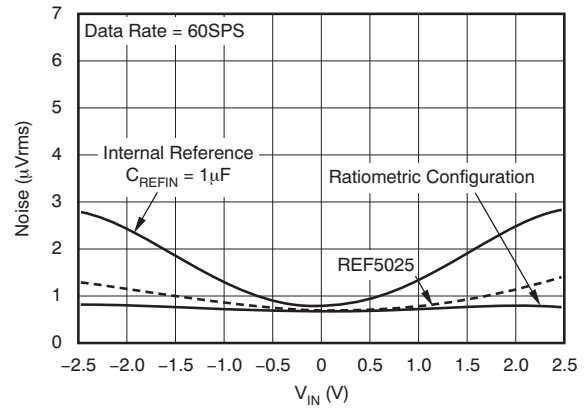

Figure 9.

NOISE vs INPUT VOLTAGE

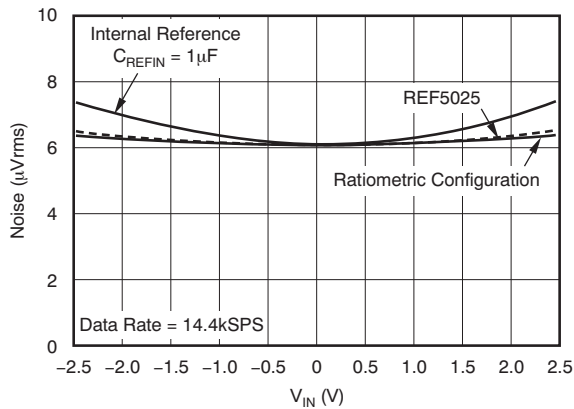

Figure 10.

NOISE vs REFERENCE VOLTAGE

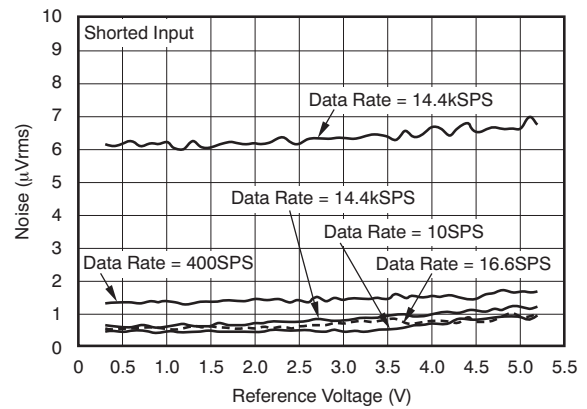

Figure 11.

LINEARITY DEVIATION vs INPUT LEVEL

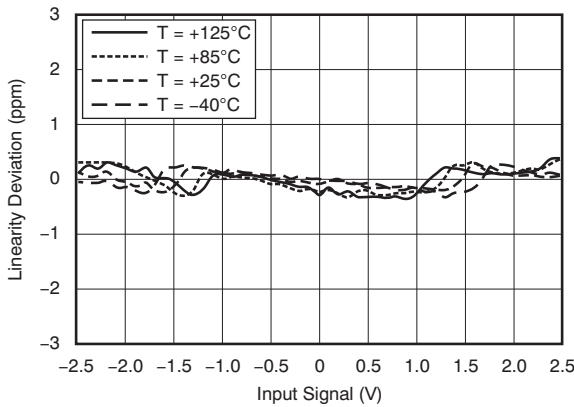

Figure 12.

INTEGRAL NONLINEARITY vs TEMPERATURE

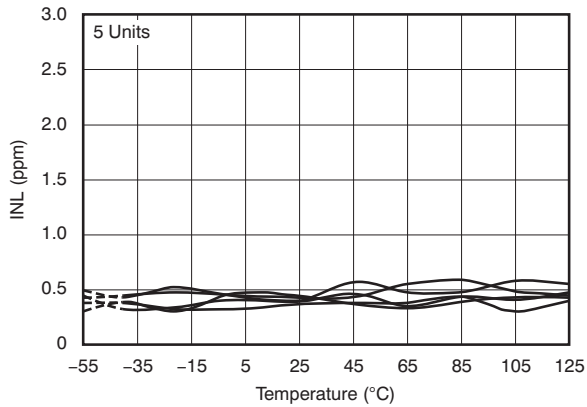

Figure 13.

TYPICAL CHARACTERISTICS (continued)

At $T_A = +25^\circ\text{C}$, $AV_{DD} = +2.5\text{V}$, $AV_{SS} = -2.5\text{V}$, $DV_{DD} = 3.3\text{V}$, $V_{REF} = 2.5\text{V}$, $V_{REFN} = AV_{SS}$, $f_{CLK} = 7.3728\text{MHz}$, and $f_{DATA} = 60\text{SPS}$, unless otherwise noted.

OFFSET vs TEMPERATURE

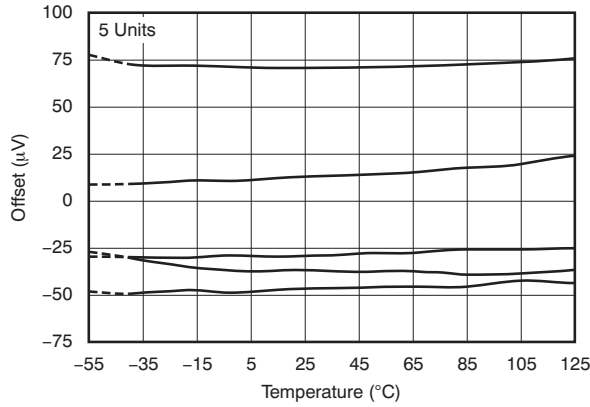

Figure 14.

GAIN vs TEMPERATURE

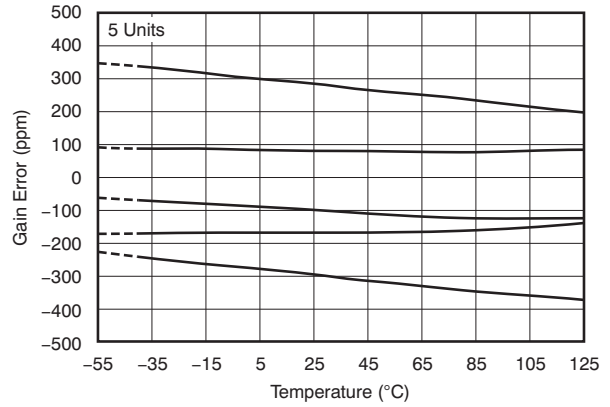

Figure 15.

OFFSET DRIFT DISTRIBUTION HISTOGRAM

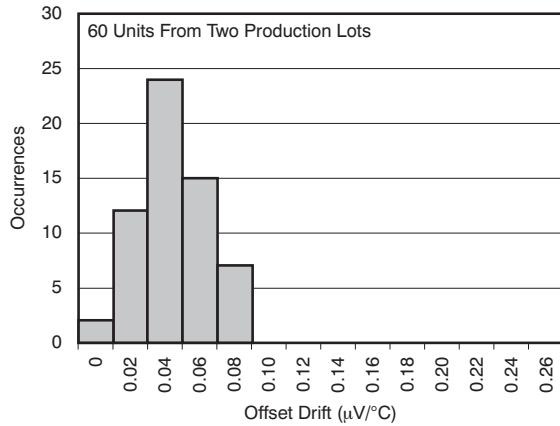

Figure 16.

GAIN DRIFT DISTRIBUTION HISTOGRAM

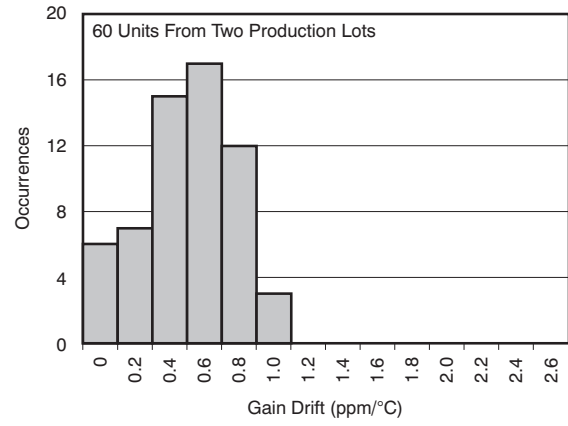

Figure 17.

INTEGRAL NONLINEARITY vs REFERENCE VOLTAGE

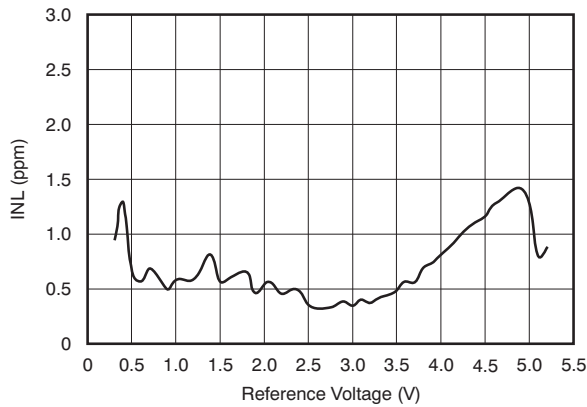

Figure 18.

GAIN ERROR AND OFFSET vs REFERENCE VOLTAGE

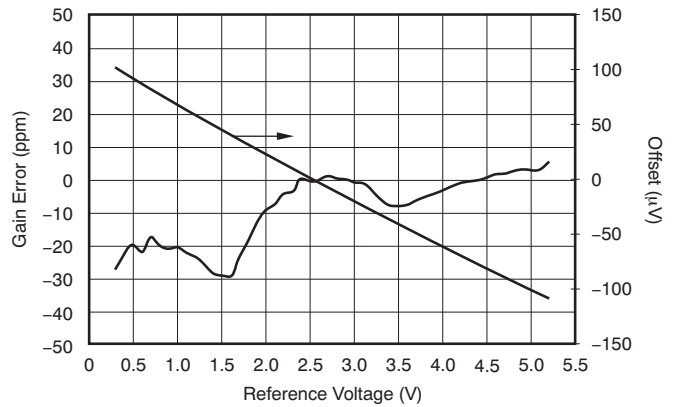

Figure 19.

TYPICAL CHARACTERISTICS (continued)

At $T_A = +25^\circ\text{C}$, $AVDD = +2.5\text{V}$, $AVSS = -2.5\text{V}$, $DVDD = 3.3\text{V}$, $V_{REF} = 2.5\text{V}$, $V_{REFN} = AVSS$, $f_{CLK} = 7.3728\text{MHz}$, and $f_{DATA} = 60\text{SPS}$, unless otherwise noted.

POWER-SUPPLY AND COMMON-MODE REJECTION vs FREQUENCY

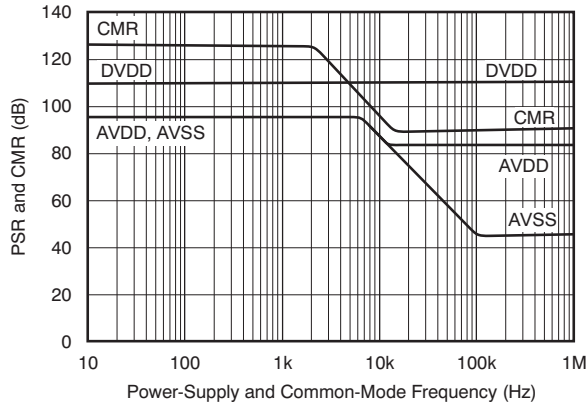

Figure 20.

POWER-SUPPLY CURRENT vs TEMPERATURE

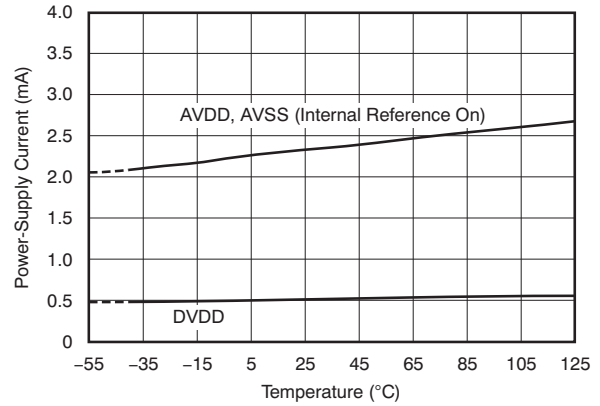

Figure 21.

INTERNAL REFERENCE VOLTAGE vs TEMPERATURE

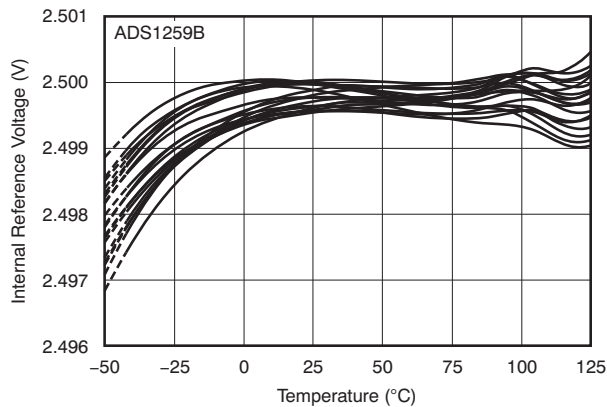

Figure 22.

INTERNAL REFERENCE VOLTAGE vs TEMPERATURE

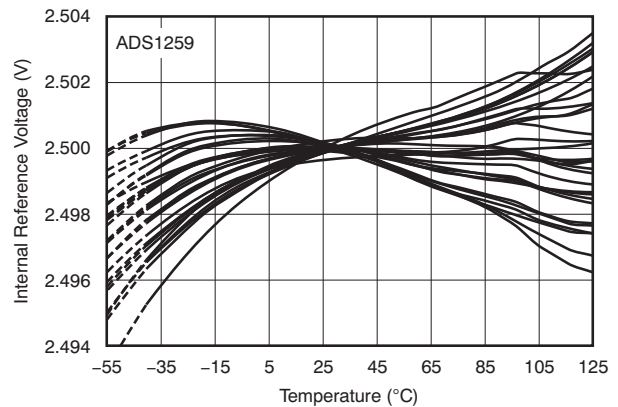

Figure 23.

OUT-OF-RANGE THRESHOLD DISTRIBUTION HISTOGRAM

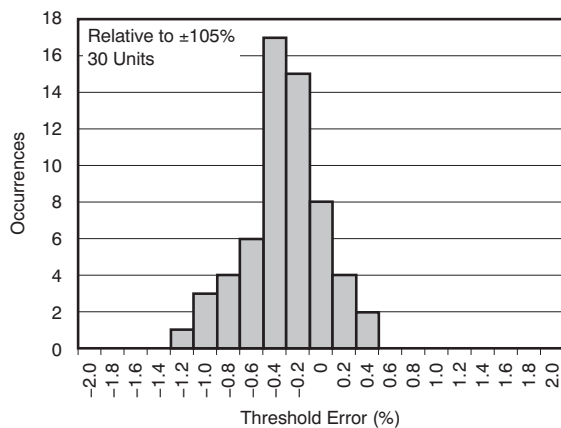

Figure 24.

OUT-OF-RANGE THRESHOLD vs TEMPERATURE

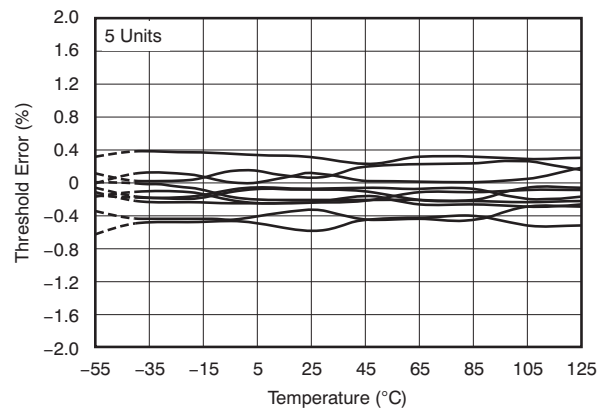

Figure 25.

TYPICAL CHARACTERISTICS (continued)

At $T_A = +25^\circ\text{C}$, $AVDD = +2.5\text{V}$, $AVSS = -2.5\text{V}$, $DVDD = 3.3\text{V}$, $V_{REF} = 2.5\text{V}$, $V_{REFN} = AVSS$, $f_{CLK} = 7.3728\text{MHz}$, and $f_{DATA} = 60\text{SPS}$, unless otherwise noted.

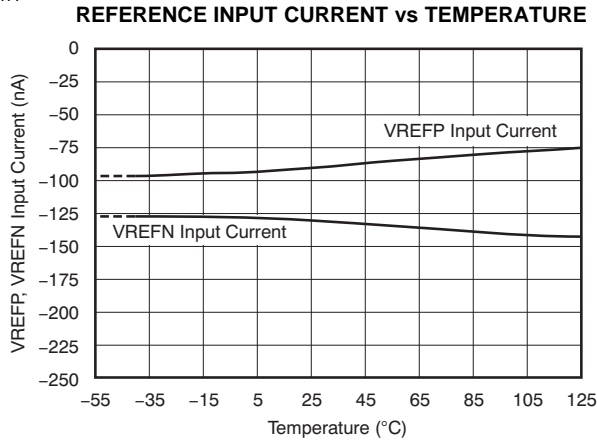

Figure 26.

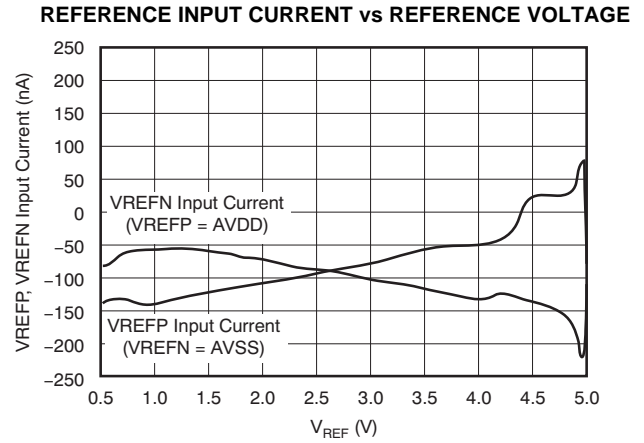

Figure 27.

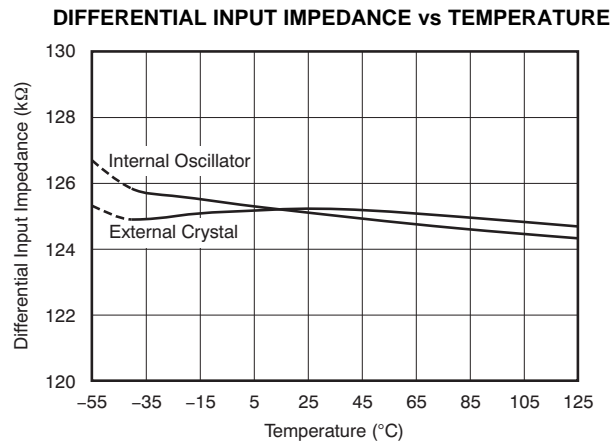

Figure 28.

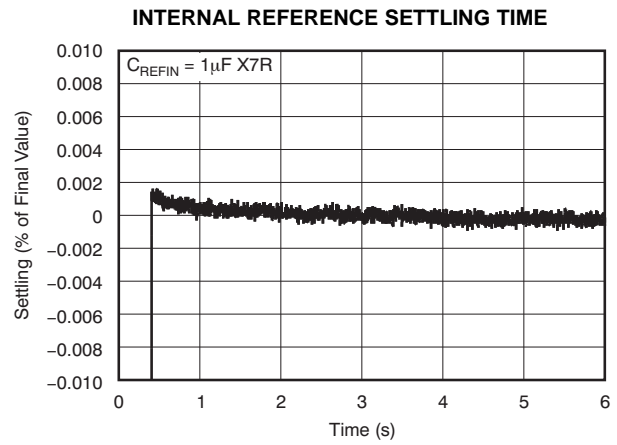

Figure 29.

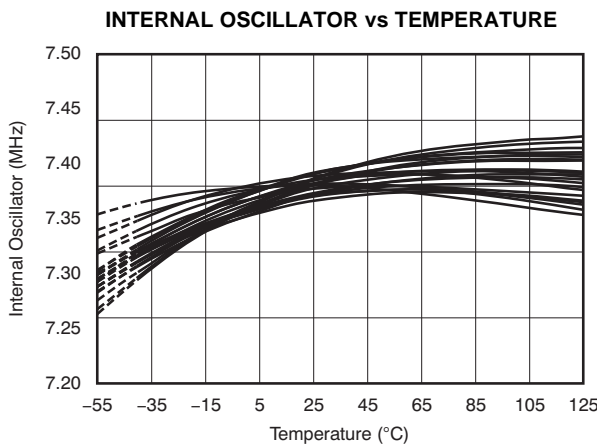

Figure 30.

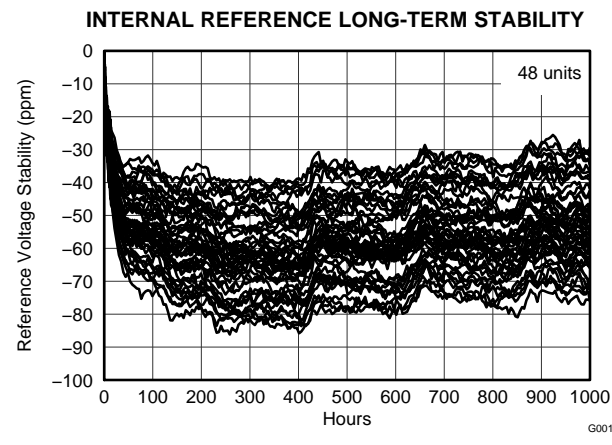

Figure 31.

OVERVIEW

The ADS1259 is a high-linearity, low drift analog-to-digital converter (ADC) designed for the needs of industrial process control, precision instrumentation, and similar applications. The converter provides high-resolution, 24-bit output data at sample rates ranging from 10SPS to 14.4kSPS.

Figure 32 shows a block diagram of the ADS1259. The device allows unipolar or bipolar analog power-supply configuration ($AVDD - AVSS = 5V$ total). The analog supplies may be set to single +5V to accept unipolar (or offset-bipolar) signals or the supplies can be set to $\pm 2.5V$ to accept true bipolar signals. The operating range of the digital power supply (DVDD) is 2.7V to 5V.

An internal low dropout regulator (LDO) powers the digital core from the DVDD supply while the device I/O operates directly from DVDD. BYPASS is the LDO output and requires a 0.1 μF or larger capacitor to ground.

The inherently stable, fourth-order, $\Delta\Sigma$ modulator measures the differential input signal [$V_{IN} = (AINP - AINN)$] against the differential reference [$V_{REF} = (VREFP - VREFN)$]. A fast responding out-of-range detector flags the output data if the input should over-range while converting.

The digital filter receives the modulator signal and provides the digital output. The filter consists of a fifth-order sinc filter followed by a programmable averager, selectable as either a sinc¹ or sinc². In sinc¹ mode, the filter settles in a single conversion. The programmable averaging yields output data rates from 10SPS to 14.4kSPS.

The ADS1259 integrates a low-drift, low-noise +2.5V reference. The internal reference can drive loads up to $\pm 10mA$. The ADS1259 also operates from an external reference if desired. The reference input is buffered to reduce loading of external circuits.

An onboard oscillator is provided as the clock source for the device. Optionally, an external crystal can be used. As a third clock option, the device can be driven by an external clock source. SYNCOUT is an output that provides a 1/8 rate clock intended to drive the chopping clock input of the PGA280.

Gain and offset registers scale the digital filter output to produce the final code value. On-command calibration corrects for system offset and gain errors.

An SPI-compatible serial interface provides the control and configuration as well as the data interface to the ADS1259. Onboard registers combined with commands are used to control and configure the device.

The $\overline{RESET/PWDN}$ pin is dual function. A momentary low resets the device and, if the pin is held low, powers down the device. The START pin, as well as commands, controls the conversions.

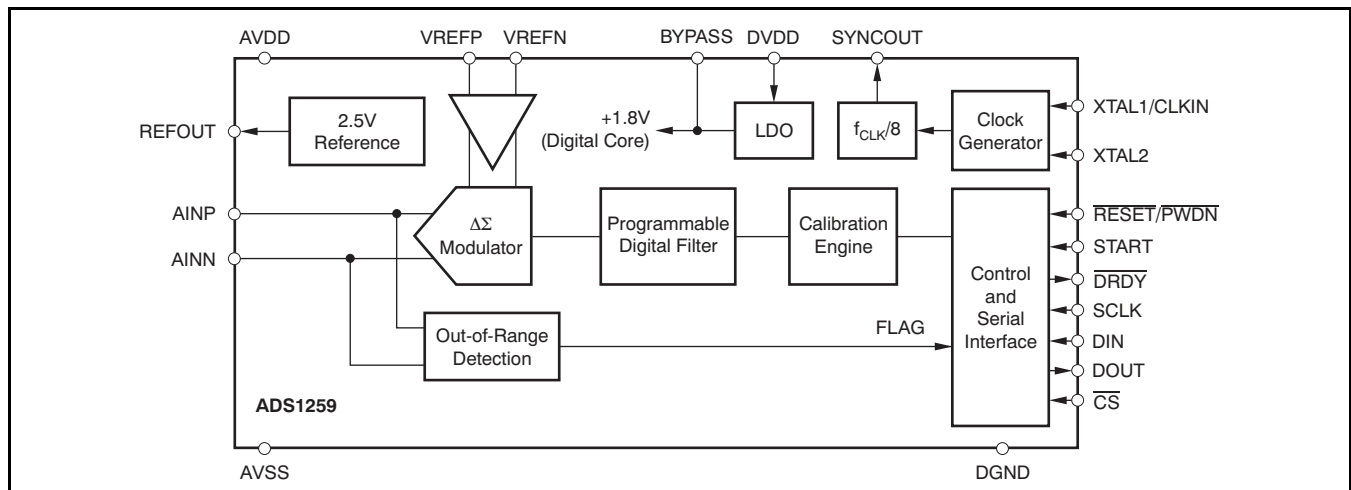

Figure 32. ADS1259 Block Diagram

NOISE PERFORMANCE

The ADS1259 offers excellent noise performance that can be optimized by adjusting the data rate and by selection of the digital filter mode. As the averaging is increased by reducing the data rate, the noise drops correspondingly. Additionally, because the sinc² digital filter provides more filtering than the sinc¹ digital filter, sinc² provides lower noise conversions. Table 1 shows the noise as a function of data rate and filter mode.

Table 1 expresses typical noise data in several ways: RMS noise, effective number of bits (ENOB), and noise-free bits. ENOB is calculated from Equation 1:

$$ENOB = \frac{\ln \left(\frac{FSR}{RMS\ Noise} \right)}{\ln(2)}$$

Where:

$$FSR = 2V_{REF} \quad (1)$$

The calculation of noise-free bits uses the same formula as Equation 1, except that the peak-to-peak noise value is used instead of RMS noise.

ADC

The analog-to-digital converter (ADC) section of the ADS1259 is composed of two blocks: a high accuracy modulator and a programmable digital filter.

MODULATOR

The high-performance modulator is an inherently-stable, fourth-order, ΔΣ, 2 + 2 pipelined structure, as shown in Figure 33. It shifts the quantization noise to a higher frequency (out of the passband) where digital filtering can easily remove it.

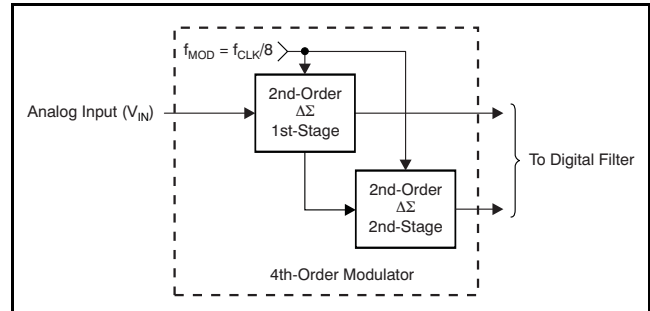

Figure 33. Fourth-Order Modulator

The modulator first stage converts the analog input voltage into a pulse-code modulated (PCM) stream. When the level of differential analog input (AINP – AINN) is near the level of the reference voltage (VREFP – VREFN), the 1s density of the PCM data stream is at its highest. When the level of the differential analog input is near zero, the PCM 0s and 1s densities are nearly equal. At the two extremes of the analog input levels (+FS and –FS), the 1s density of the PCM streams are approximately +90% and +10%, respectively.

The modulator second stage produces a 1s density data stream designed to cancel the quantization noise of the first stage. The data streams of the two stages are then combined in the digital filter stage.

Table 1. Typical Noise Data vs Data Rate and Digital Filter⁽¹⁾

DATA RATE (SPS)	SAMPLE SIZE ⁽²⁾	SINC ¹ DIGITAL FILTER				SINC ² DIGITAL FILTER			
		NOISE (μV _{RMS})	NOISE (μV _{PP})	ENOB (RMS)	NOISE-FREE BITS	NOISE (μV _{RMS})	NOISE (μV _{PP})	ENOB (RMS)	NOISE-FREE BITS
10	128	0.5	1.8	23.3	21.4	0.45	1.6	23.4	21.6
16.6	256	0.55	2.4	23.1	21.0	0.5	2	23.3	21.3
50	512	0.65	3.5	22.9	20.4	0.6	3	23.0	20.7
60	512	0.7	4	22.8	20.3	0.65	3.5	22.9	20.4
400	4096	1.4	9.5	21.8	19.0	1.2	8.3	22.0	19.2
1200	8192	2.3	17	21.1	18.2	2	14	21.3	18.4
3600	8192	3.9	32	20.3	17.3	3.4	27	20.5	17.5
14400	8192	6.2	50	19.6	16.6	(3)	(3)	(3)	(3)

(1) Noise data taken with shorted analog inputs and internal 2.5V reference using the circuit of Figure 64.

(2) Data sample sizes used for analysis.

(3) Same as sinc¹ mode.

MODULATOR OVERLOAD BEHAVIOR

The ADS1259 modulator is inherently stable and therefore has predictable recovery behavior resulting from an input overdrive condition. The modulator does not exhibit the self-resetting behavior of other modulator types, which often results in unstable output conversion results when overdriven.

The ADS1259 modulator outputs a 1s density data stream at 90% duty cycle with the positive full-scale input signal applied (10% duty cycle with the negative full-scale signal). If the input is overdriven past 90% modulation, but below 100% modulation (10% and 0% for negative overdrive, respectively), the modulator remains stable and continues to output the 1s density data stream. The digital filter may or may not clip the output codes to +FS or –FS, depending on the duration of the overdrive. When the input is returned to the normal range from a long duration overdrive (worst case), the modulator returns immediately to the normal range, but the group delay of the digital filter delays the return of the conversion result to within the linear range (one reading for the sinc¹ filter and two readings for completely settled data).

If the inputs are sufficiently overdriven to drive the modulator to full duty cycle (that is, all 1s or all 0s), the modulator enters a stable saturated state. The digital output code may clip to +FS or –FS, again depending on the duration. A small duration overdrive may not always clip the output code. When the input returns to the normal range, the modulator requires up to 12 modulator clock cycles (f_{MOD}) to exit saturation and return to the linear region. The digital filter requires two additional conversions (sinc¹, more for sinc²) for fully settled data.

In the extreme case of over-range, either input is overdriven exceeding that either analog supply voltage plus an internal ESD diode drop. The internal ESD diodes begin to conduct and the signal on the input is clipped. If the differential input signal range is not exceeded, the modulator remains in linear operation. If the differential input signal range is exceeded, the modulator is saturated but stable, and outputs all 1s or 0s. When the input overdrive is removed, the diodes recovery quickly and the

ADS1259 recovers as normal. Note that the linear input range is $\pm 100\text{mV}$ beyond the analog supply voltages; with input levels greater than this range, use care to limit the input current to 100mA peak transient (10mA continuous).

INPUT OUT-OF-RANGE DETECTION (FLAG)

The ADS1259 has a fast-responding out-of-range circuit that triggers when the differential input exceeds +105% or –105% of FSR ($\pm 1.05 V_{REF}$). The out-of-range circuit latches the result of the comparator output and appends the result as either the LSB of conversion data or as bit 7 of the data checksum byte. After the conversion data are read, or after a new conversion is started, the comparator latch is reset. Figure 34 and Figure 35 show the detection block diagram and the detection operation, respectively. See the *Data Checksum Byte and FLAG Bit* section for more detail.

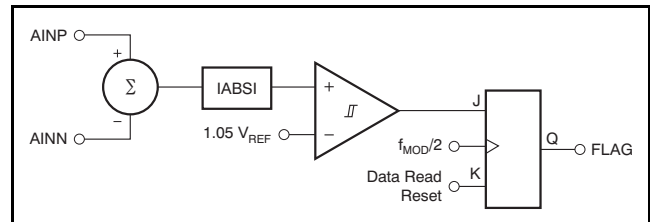

Figure 34. Input Out-Of-Range Detect Block Diagram

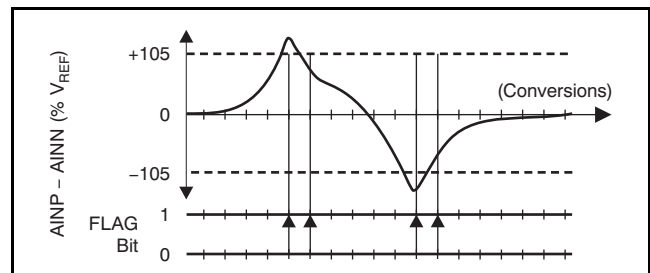

Figure 35. Input Out-Of-Range Detect Operation

ANALOG INPUTS (AINP, AINN)

The ADS1259 measures the differential input signal $V_{IN} = (AINP - AINN)$ against the differential reference $V_{REF} = (VREFP - VREFN)$ using internal capacitors that are continuously charged and discharged. Figure 37 shows the simplified schematic of the ADC input circuitry; the right side of the figure illustrates the input circuitry with the capacitors and switches replaced by an equivalent circuit. Figure 36 demonstrates the ON/OFF timings for the switches of Figure 37.

In Figure 37, S_1 switches close during the input sampling phase. With switch S_1 closed, C_{A1} charges to AINP, C_{A2} charges to AINN, and C_B charges to $(AINP - AINN)$. For the discharge phase, S_1 opens first and then S_2 closes. C_{A1} and C_{A2} discharge to approximately to $AVSS + 2.5V$ and C_B discharges to 0V. This two-phase sample/discharge cycle repeats with a period of $t_{SAMPLE} = 1/f_{MOD}$. f_{MOD} is the operating frequency of the modulator, where $f_{MOD} = f_{CLK}/8$.

The charging of the input sampling capacitors draws a transient current from the source driving the ADS1259 ADC inputs. The average value of this current can be used to calculate an effective impedance (R_{EFF}) where $R_{EFF} = V_{IN}/I_{AVERAGE}$. These impedances scale inversely with f_{MOD} . For example, if f_{MOD} is reduced by a factor of two, the impedances double. Note that the sampling capacitors can vary $\pm 15\%$ over production lots and typically vary 1% with temperature. The variations of the sampling capacitors have a corresponding effect on the analog input impedance.

ESD diodes protect the analog inputs. To keep these diodes from turning on, make sure the voltages on the input pins do not go below $AVSS$ by more than 300mV, and likewise do not exceed $AVDD$ by more than 300mV.

$$AVSS - 300mV < (AINP \text{ or } AINN) < AVDD + 300mV.$$

Note that the valid input range is:

$$AVSS - 100mV < (AINP \text{ or } AINN) < AVDD + 100mV$$

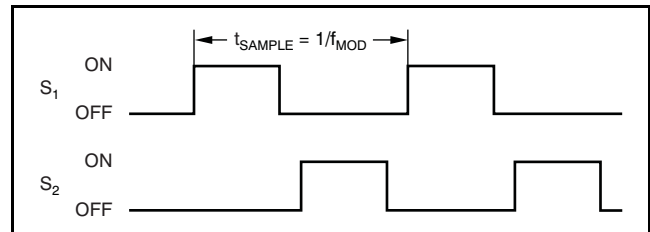

Figure 36. S_1 and S_2 Switch Timing for Figure 37

Although optimized for differential signals, the ADS1259 inputs may be driven with a single-ended signal by fixing one input to $AVSS$ or mid-supply. Full dynamic range is achieved when the inputs are differentially driven $\pm V_{REF}$.

As a result of the switched-capacitor input structure of the ADS1259, a buffer is recommended to drive the analog inputs. An input filter comprised of 20 Ω to 50 Ω resistors and 10nF capacitors should be used between the buffer and the ADS1259 inputs.

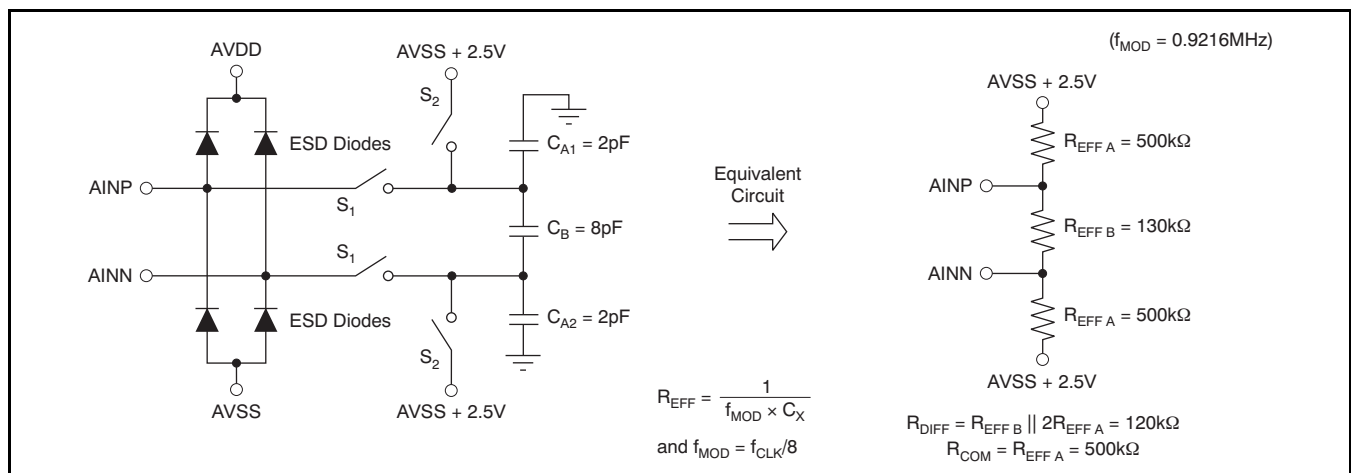

Figure 37. Simplified ADC Input Structure

REFERENCE

The ADS1259 includes an onboard voltage reference with a low temperature coefficient. The reference voltage is 2.5V with the capability of sinking and sourcing 10mA via the REFOUT pin. The ADS1259 can also operate from an external reference. The external reference is the default selection. Refer to [Figure 38](#) for a reference block diagram.

Internal Reference

The reference output is provided between pins REFOUT and AVSS. Because the reference output return shares the same pin as AVSS, route the reference return trace and the AVSS trace independently as Kelvin-connected printed circuit board (PCB) traces. For stability reasons, connect a 1µF capacitor between REFOUT and AVSS.

An internal switch connects the internal reference to

the ADC reference input pins, VREFP and VREFN. (Note that these device pins are not intended to drive external circuits.) An external 1µF capacitor, connected from VREFP to VREFN, is recommended for noise reduction. The capacitor can be increased for increased noise filtering, but the settling time of the reference may also increase. The settling time should be considered upon activating the internal reference.

See [Figure 29](#) for typical reference settling $C_{REFIN} = 1\mu F$. The capacitor dielectric absorption results in increased settling time for RC filter circuits.

To activate the internal reference, set the register bit RBIAS = 1. This enables the reference bias. Once biased, the internal reference can then be selected as the ADC reference by the register bit EXTREF. EXTREF = 0 closes the internal switches.

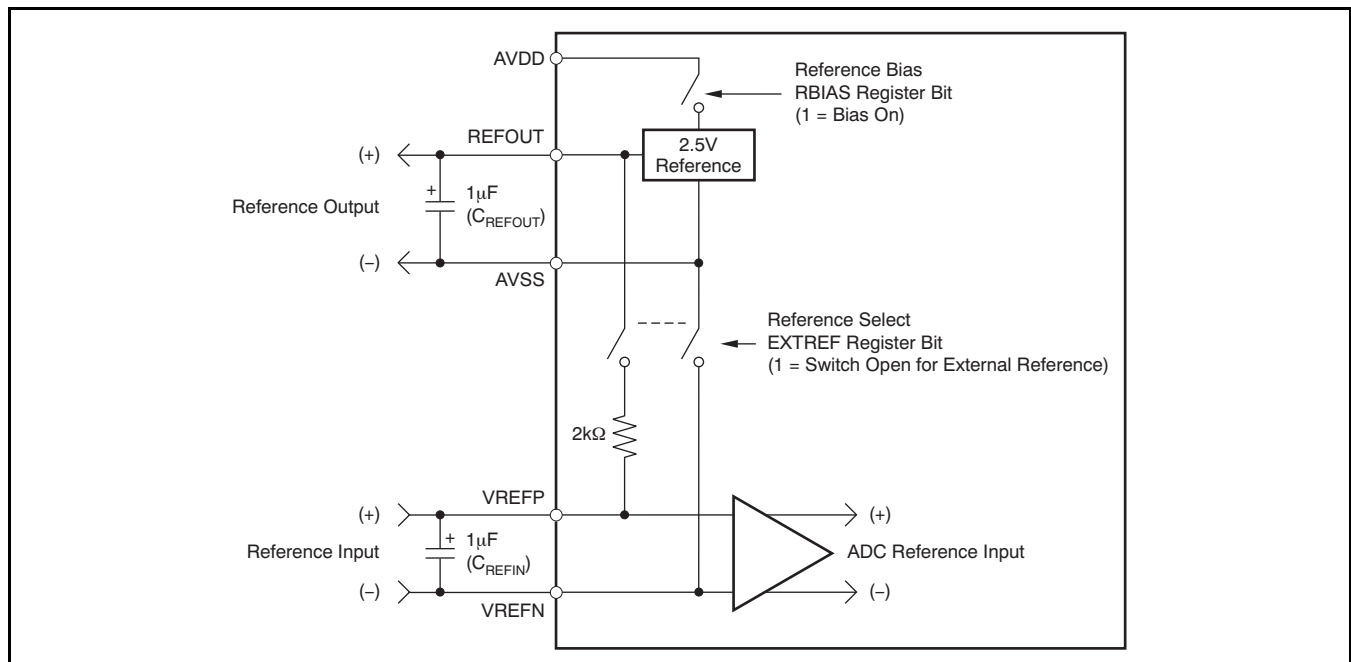

Figure 38. Reference Block Diagram

Table 2. Reference Selection for [Figure 38](#)

ADS1259 REFERENCE	RBIAS REGISTER BIT	EXTREF REGISTER BIT
Internal	1	0
External	See ⁽¹⁾	1

(1) If the reference output is not required, set RBIAS = 0. If the reference output is enabled (RBIAS = 1), an external 1µF capacitor must be used between REFOUT and AVSS.

Reference Drift

The ADS1259 internal reference is designed for minimal drift error, which is defined as the change in reference voltage over temperature. The drift is calculated using the box method, as described by [Equation 2](#).

$$\text{Drift} = \left[\frac{V_{\text{REFMAX}} - V_{\text{REFMIN}}}{V_{\text{REFNOM}} \times \text{Temp Range}} \right] \times 10^6 \text{ (ppm)}$$

Where:

V_{REFMAX} , V_{REFMIN} , and V_{REFNOM} are the maximum, minimum, and nominal reference output voltages, respectively, over the specified temperature range. (2)

The ADS1259 internal reference features a maximum drift coefficient of 5ppm/°C over 0°C to +85°C operating range and 12ppm/°C over –40°C to +105°C operating range.

Thermal Hysteresis

Thermal hysteresis of the internal reference is defined as the change in voltage after operating the device at +25°C, cycling the device through the specified temperature range, and returning to +25°C. It can be expressed as [Equation 3](#).

$$V_{\text{HYST}} = \left[\frac{|V_{\text{PRE}} - V_{\text{POST}}|}{V_{\text{NOM}}} \right] \times 10^6 \text{ (ppm)}$$

Where:

V_{HYST} = thermal hysteresis (in units of ppm).
 V_{NOM} = nominal reference voltage (+2.5V).
 V_{PRE} = reference voltage measured at +25°C pretemperature cycling.
 V_{POST} = reference voltage measured after the device has been cycled from +25°C through the temperature range of 0°C and +85°C and returned to +25°C. (3)

External Reference

To select the ADS1259 for external reference operation, set the EXTREF register bit = 1 (default). If desired, the internal reference can continue to provide a +2.5V reference output via the REFOUT and AVSS pins. In this case, set the RBIAS register bit = 1 to power the internal reference. If the internal reference is activated, an external 1µF capacitor from REFOUT to AVSS is required.

For external reference applications, place a 1µF (minimum) capacitor close to the VREFP and VREFN pins.

Because the ADS1259 measures the signal inputs (AINP and AINN) against the reference inputs (VREFP and VREFN), reference noise and drift may degrade overall system performance. In ratiometric measurement applications, reference noise and drift have a cancelling effect. In absolute measurement applications, reference noise and drift directly effect the conversion results.

Voltage Reference Inputs (VREFP, VREFN)

ESD diodes protect the reference inputs. To keep these diodes from turning on, make sure the voltages on the reference pins do not go below AVSS by more than 300mV, and likewise do not exceed AVDD by more than 300mV.

The absolute maximum reference input range is:

$$\text{AVSS} - 300\text{mV} < (\text{VREFP or VREFN}) < \text{AVDD} + 300\text{mV} \text{ (4)}$$

Note that the valid operating range of the reference inputs are shown in the [Electrical Characteristics](#) table.

DIGITAL FILTER

The programmable low-pass digital filter receives the modulator output and produces a high-resolution digital output. By adjusting the amount of filtering, tradeoffs can be made between resolution and data rate: filter more for higher resolution, filter less for higher data rate.

The filter consists of two sections: a fixed decimation sinc^5 filter followed by a variable decimation filter, configurable as sinc^1 or sinc^2 , as illustrated in Figure 39. The sinc^5 filter has fixed decimation of 64 and reduces the data rate of the modulator from $f_{\text{CLK}}/8$ to $f_{\text{CLK}}/512$. The second filter stage receives the data from the sinc^5 filter. The second filter stage has programmable averaging (or decimation) and can be configured in either sinc^1 or sinc^2 mode. The decimation ratio of this stage sets the final output data rate. As detailed in Table 3, the DR[2:0] register bits program the decimation ratio and the final output data rate. The output data rates are identical for both sinc^1 and sinc^2 filters.

Table 3. Decimation Ratio of Final Filter Stage

DR[2:0] REGISTER BITS	DECIMATION RATIO (R)	DATA RATE (SPS)
111	1	14400
110	4	3600
101	12	1200
100	36	400
011	240	60
010	288	50
001	864	16.6
000	1440	10

The SINC2 register bit selects either the sinc^1 or sinc^2 filter. The sinc^1 filter settles in one conversion cycle while the sinc^2 filter settles in two conversion cycles. However, the sinc^2 filter has the benefit of wider frequency notches which improve line cycle rejection.

FREQUENCY RESPONSE

The low-pass digital filter sets the overall frequency response of the ADS1259. The filter response is the product of the fixed and programmable filter sections, and is given by Equation 5:

$$|H(f)| = |H_{\text{sinc}^5}(f)| \times |H_{\text{sinc}^N}(f)| = \left| \frac{\sin\left(\frac{512\pi \times f}{f_{\text{CLK}}}\right)}{64 \times \sin\left(\frac{8\pi \times f}{f_{\text{CLK}}}\right)} \right|^5 \times \left| \frac{\sin\left(\frac{512\pi \times R \times f}{f_{\text{CLK}}}\right)}{R \times \sin\left(\frac{512\pi \times f}{f_{\text{CLK}}}\right)} \right|^N$$

where:

$$N = 1 (\text{sinc}^1)$$

$$N = 2 (\text{sinc}^2)$$

$$R = \text{Decimation ratio (refer to Table 3)} \quad (5)$$

The digital filter attenuates noise on the modulator output, including noise from within the ADS1259 and external noise present within the ADS1259 input signal. Adjusting the filtering by changing the decimation ratio used in the programmable filter changes the filter bandwidth. With a higher number of decimation, the bandwidth is reduced and more noise is attenuated.

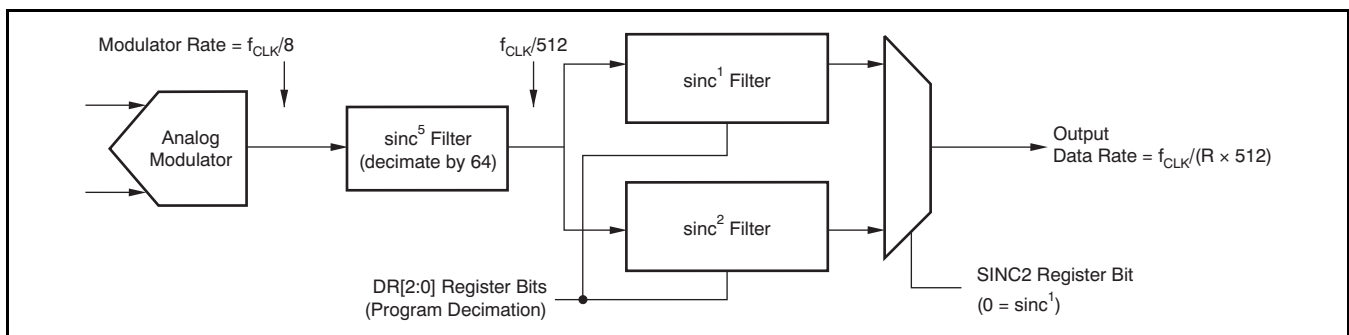

Figure 39. Block Diagram of Digital Filter

The sinc⁵ filter produces wide notches at $f_{CLK}/512$ and multiples thereof. At these frequencies the filter has zero gain. Figure 40 shows the response data rate = 14.4kSPS.

With decimation of the second stage, the wide notches produced by the sinc⁵ filter remain, but a number of narrow notches are superimposed in the response. The first of the notches occur at the data rate. The number of superimposed notches is determined by the decimation ratio, minus 1.

The second stage filter has notches (or zeroes) at the data rate and multiples thereof. Figure 41 shows the response of the second stage filter combined with the sinc⁵ stage. Decimation of 4 produces three equally-spaced notches between each main notch of the sinc⁵ filter. The frequency response of the other data rates (higher decimation ratios) produces a similar pattern, but with more equally-spaced notches between the main sinc⁵ notches. Table 4 lists the first notch frequency and the -3dB bandwidth.

Figure 42 illustrates the detail of the magnitude response with data rate = 60SPS. Note that input frequencies within the ±1% 60Hz bandwidth are attenuated 40dB by the sinc¹ filter and 80dB by the sinc² filter.

Table 4. First Notch Frequency and -3dB Filter Bandwidth⁽¹⁾

DATA RATE (SPS)	FIRST NOTCH (Hz)	-3dB BANDWIDTH (Hz)	
		sinc ¹	sinc ²
10 ⁽²⁾	10	4.3	3.1
16.6 ⁽³⁾	16.6	7.3	5.2
50	50	22	16
60	60	27	19
400	400	177	127
1200	1200	525	380
3600	3600	1440	1100
14400	14400	2930	See ⁽⁴⁾

- (1) $f_{CLK} = 7.3728\text{MHz}$.
- (2) Notch at 50Hz and 60Hz.
- (3) Notch at 50Hz.
- (4) Same as sinc¹.

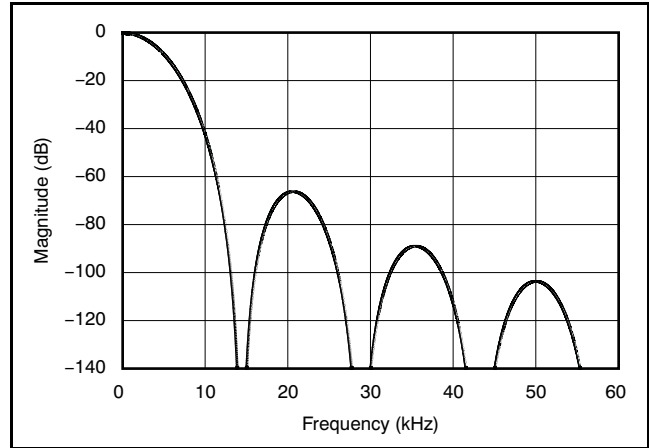

Figure 40. Frequency Response for Data Rate = 14.4kSPS

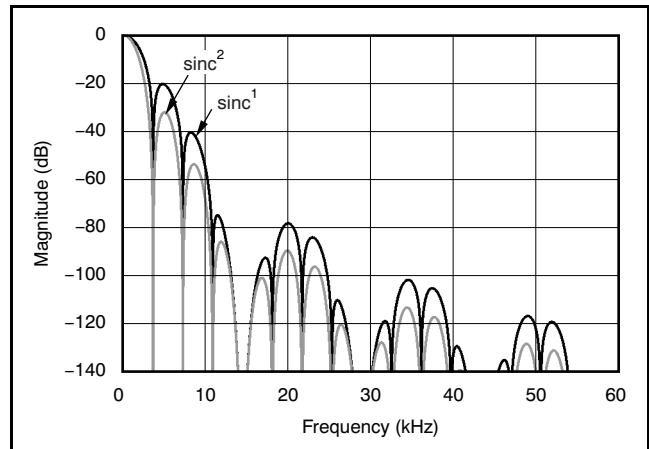

Figure 41. Frequency Response (Data Rate = 3600SPS, R = 4)

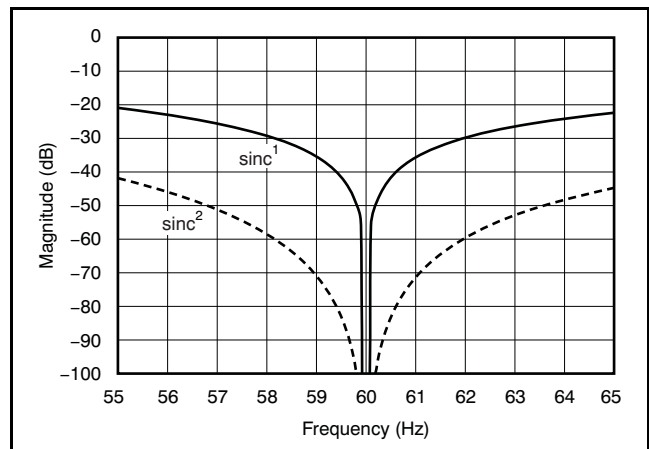

Figure 42. Magnitude Response for Data Rate = 60SPS

ALIASING

The low-pass characteristic of the digital filter repeats at multiples of the modulator rate ($f_{MOD} = f_{CLK}/8$). Figure 43 shows the responses plotted out to 7.3728MHz at the data rate of 14.4kSPS. Notice how the responses near dc, 0.9216MHz, 1.8432MHz, 2.7698MHz, etc, are the same as given by $f = Nf_{MOD} \pm f_{DATA}$ where $N = 0, 1, 2$, etc. The digital filter attenuates high-frequency noise on the ADS1259 inputs up to the frequency where the response repeats. However, noise or frequency components existing in the signal where the response repeats alias into the passband. Often, a simple RC antialias filter is sufficient to reject these input frequencies.

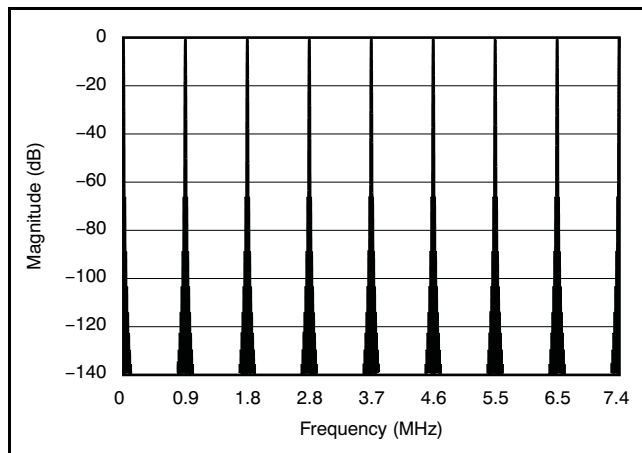

Figure 43. Frequency Response to 7.3728MHz (Data Rate = 14400SPS)

CLOCK SOURCE

There are three ways to provide the ADS1259 clock: the internal oscillator, an external clock, or an external crystal/ceramic resonator. The ADS1259 selects the clock source automatically. Figure 44 shows the clock select block. If either external clock sources are present, the internal oscillator is disabled and the external clock source is selected. If no external clock is present, the internal oscillator is selected. The ADS1259 continuously monitors the clock source. The clock source can be polled by the EXTCLK bit (bit 6 of register CONFIG2), 0 = internal oscillator, 1 = external clock.

The data rate and corresponding filter notches scale by the accuracy of clock frequency. Consideration should be given to the clock accuracy and the corresponding effect to the notch frequency locations.

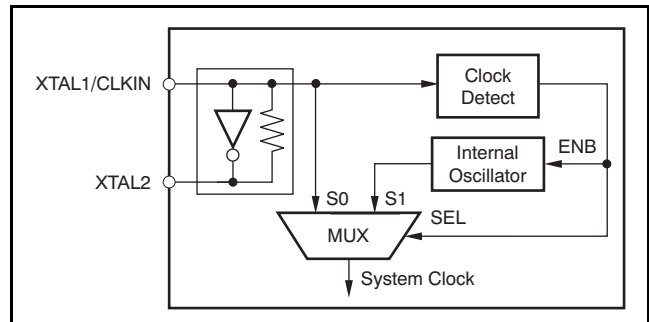

Figure 44. Equivalent Circuitry of the Clock Source

Internal Oscillator

Figure 45 shows the internal oscillator connection. XTAL1/CLKIN is grounded and XTAL2 is not connected (floating). The internal oscillator draws approximately 40µA from the DVDD supply. Note that the internal oscillator has ±2% accuracy over temperature. The oscillator accuracy has a corresponding effect on line-cycle notch frequency locations.

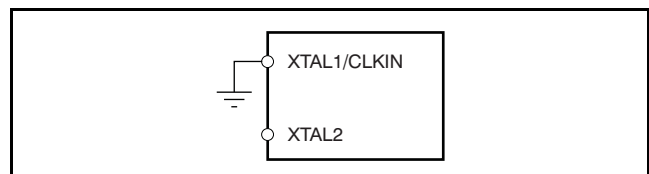

Figure 45. Internal Oscillator Connection

External Clock

Figure 46 shows the external clock connection. The clock is applied to XTAL1/CLKIN and XTAL2 floats. Make sure a clean clock input is applied to the ADS1259, free of overshoot and glitches. A series resistor often helps to reduce overshoot and should be placed close to the driving end of the clock source.

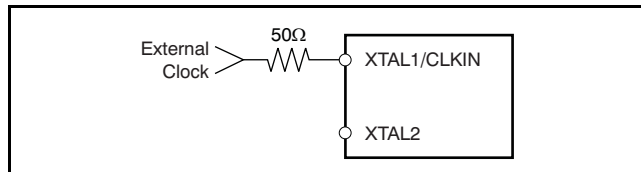

Figure 46. External Clock Connection

Crystal Oscillator

Figure 47 shows the crystal oscillator connection. The crystal connects to XTAL1/CLKIN and XTAL2 and the capacitors connect to ground. The crystal and capacitors should be placed close to the device pins with short, direct traces. Neither the XTAL1/CLKIN nor the XTAL2 pins can be used to drive any other logic. Table 5 lists the recommended crystal for the ADS1259. If using other crystals, verify the oscillator start-up behavior.

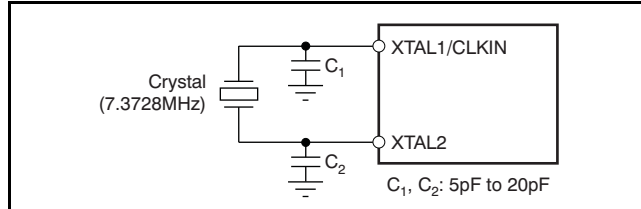

Figure 47. Crystal Connection

Table 5. Recommended Crystal

MANUFACTURER	FREQUENCY	PART NUMBER
ECS	7.3728MHz	ECS-73-18-10

SYNCOUT

SYNCOUT is a digital output pin intended to synchronize the chopping frequency of the PGA280 to the sampling frequency of the ADS1259. Synchronizing the PGA280 to the ADS1259 places the PGA280 chopped 1/f noise at an exact null in the ADS1259 frequency response, where the PGA280 1/f noise is rejected.

SYNCOUT frequency is equal to the ADS1259 clock rate divided by 8 ($f_{\text{SYNCOUT}} = f_{\text{CLK}}/8$). The output clock is enabled by the register bit SYNCOUT. Disabling the output stops the clock but the output remains actively driven low. In power-down mode, the SYNCOUT output becomes an input. As with all digital inputs, the pin must not be allowed to float. An external 1MΩ pull-down resistor is recommended to ground the input in power-down mode.

The SYNCOUT clock is reset when START is received and whenever registers CONFIG[2:0] are changed. Connect SYNCOUT to the PGA280 SYNCIN pin through a 4.7kΩ series resistor. Place the resistor as close as possible to the ADS1259 SYNCOUT pin.

SLEEP MODE

SLEEP mode is started by sending the SLEEP command. In SLEEP mode, the device enters a reduced power state and only a minimum of circuitry is kept active. The WAKEUP command exits the SLEEP mode and after which 512 f_{CLK} cycles are counted before the ADS1259 is ready for communication. The register settings are unaffected in SLEEP.

SLEEP does not change the RBIAS register bit. For quick conversions after WAKEUP, keep the internal reference bias on before entering SLEEP. Otherwise, after exiting SLEEP mode, allow time for the reference to settle. Alternatively, to minimize power consumption during SLEEP, set the internal reference bias off prior to engaging SLEEP. Note that in SLEEP mode the SPI timeout function is disabled.

BYPASS

The digital core of the ADS1259 is powered by an internal low dropout regulator (LDO). The DVDD supply is the LDO input and the BYPASS pin is the LDO output. A 1μF capacitor must be connected from the LDO output to DGND. No other load current should be drawn from the BYPASS pin.

RESET/PWDN

The $\overline{\text{RESET/PWDN}}$ pin has two functions: device power-down and device reset. Momentarily holding the pin low resets the device and holding the pin low for $2^{16} f_{\text{CLK}}$ cycles activates the Power-Down mode.

POWER-DOWN MODE

In power-down mode, internal circuit blocks are disabled (including the oscillator, reference, and SPI) and the device enters a micro-power state. To engage power-down mode, hold the $\overline{\text{RESET/PWDN}}$ pin low for $2^{16} f_{\text{CLK}}$ cycles. Note that the register contents are not saved because they are reset when $\overline{\text{RESET/PWDN}}$ goes high.

Keep the digital inputs at defined V_{IH} or V_{INL} logic levels (do not 3-state). To minimize power-supply leakage current, disable the external clock. Note that the ADS1259 digital outputs remain active in power-down. The analog signal inputs may float.

To exit power-down, take $\overline{\text{RESET/PWDN}}$ high. Wait $2^{16} f_{\text{CLK}}$ cycles before communicating to the ADS1259, as shown in Figure 48.

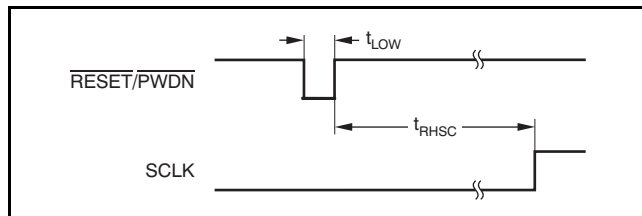

Figure 48. $\overline{\text{RESET/PWDN}}$ Timing

RESET

There are three methods to reset the ADS1259: cycle the power supplies, take $\overline{\text{RESET/PWDN}}$ low, or send the RESET opcode command.

When using the $\overline{\text{RESET/PWDN}}$ pin, take it low to force a reset. Make sure to follow the minimum pulse width timing specifications before taking the $\overline{\text{RESET}}$ pin back high.

The RESET command takes effect on the eighth falling SCLK edge of the opcode command. On reset, the configuration registers are initialized to the default states and the conversion cycle restarts. After reset, allow eight f_{CLK} cycles before communicating to the ADS1259. Note that when using the reset command, the SPI interface itself may require reset before accepting the command. See the [SPI Timing Characteristics](#) section for details.

POWER-ON SEQUENCE

The ADS1259 has three power supplies: AVDD, AVSS, and DVDD. The supplies can be sequenced in any order but be sure that at any time the analog inputs do not exceed AVDD or AVSS and the digital inputs do not exceed DVDD. After the last power supply has crossed the respective power-on threshold, $2^{16} f_{\text{CLK}}$ cycles are counted before releasing the internal reset. After the internal reset is released, the ADS1259 is ready for operation. Figure 49 shows the power-on sequence of the ADS1259.

Table 6. Timing Characteristics for Figure 48

SYMBOL	DESCRIPTION	MIN	UNIT
t_{LOW}	Pulse width low for reset	4	t_{CLK}
t_{LOW}	Pulse width low for power-down	2^{16}	t_{CLK}
t_{RHSC}	Reset high to SPI communication start	8	t_{CLK}
t_{RHSC}	Exit power-down to SPI communication start	2^{16}	t_{CLK}

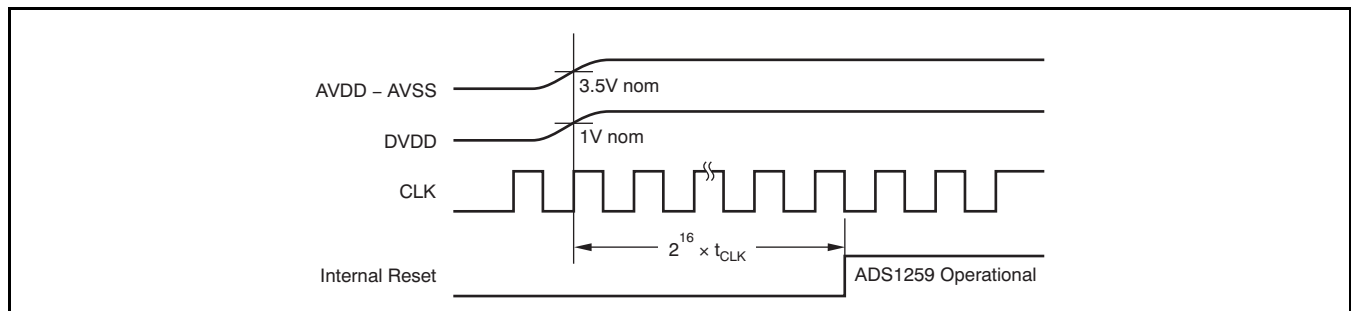
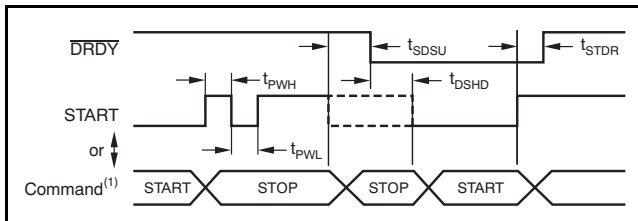

Figure 49. Power-On Sequence

START

START is a digital input that controls the ADS1259 conversions. Conversions are started when START is taken high and are stopped when START is taken low. If START is toggled during a conversion, the conversion is restarted. $\overline{\text{DRDY}}$ goes high when START is taken high. Figure 50 and Table 7 show the START timing.

Note that reasserting START within $22 t_{\text{CLK}}$ cycles of the $\overline{\text{DRDY}}$ falling edge causes $\overline{\text{DRDY}}$ to fall soon after. This conversion result should be discarded. The next $\overline{\text{DRDY}}$ falling edge, as given in Table 9, is the valid conversion data.



(1) START and STOP commands take effect on the seventh SCLK falling edge.

Figure 50. START to $\overline{\text{DRDY}}$ Timing

CONVERSION CONTROL

The conversions of the ADS1259 are controlled by either the START pin or by the START command.

When using commands to control conversions, hold the START pin low. The ADS1259 features two modes to control conversions: Gate Control mode and Pulse Control mode. The mode is selected by the PULSE register bit.

Gate Control Mode (PULSE Bit = 0, Default)

Conversions begin when either the START pin is taken high or when the START command is sent. Conversions continue indefinitely until the START pin is taken low or the STOP command is transmitted. As seen in Figure 51, $\overline{\text{DRDY}}$ is forced high when the conversion starts and falls low when data are ready. When stopped, the conversion in process completes and further conversions are halted. Figure 50 and Table 7 show the timing of $\overline{\text{DRDY}}$ and START.

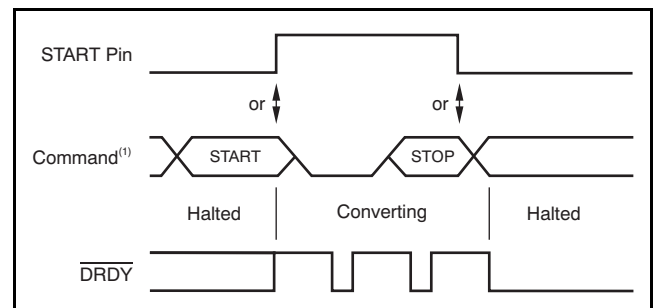

(1) START and STOP opcode commands take effect on the seventh SCLK falling edge.

Figure 51. Gate Control Mode

Table 7. START Timing (See Figure 50)

SYMBOL	DESCRIPTION	MIN	MAX	UNIT
t_{SDSU}	START pin low or STOP opcode to $\overline{\text{DRDY}}$ setup time to halt further conversions	16		t_{CLK}
t_{DSHD}	START pin low or STOP opcode hold time to complete current conversion (gate mode)	16		t_{CLK}
$t_{\text{PWH, L}}$	START pin pulse width high, low	4		t_{CLK}
t_{STDR}	START pin rising edge to $\overline{\text{DRDY}}$ rising edge		4	t_{CLK}

Pulse Control Mode (PULSE Bit = 1)

In the Pulse Control mode, the ADS1259 performs a single conversion when either the START pin is taken high or when the START command is sent. As seen in Figure 52, \overline{DRDY} goes high when the conversion is started. When the conversion is complete, \overline{DRDY} goes low and further conversions are halted. To start a new conversion, transition the START pin back to high, or transmit the START opcode again.

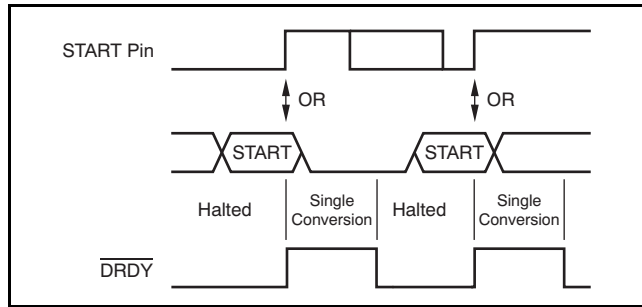

(1) START opcode command takes effect on the seventh SCLK falling edge.

Figure 52. Pulse Control Mode

CONVERSION SETTling TIME

The ADS1259 features a digital filter architecture in which settling time can be traded for wide filter notches, resulting in improved line-cycle rejection. This trade-off is determined by the selection of the sinc¹ or sinc² filter. The sinc¹ filter settles in a single cycle while the sinc² filter provides wide-width filter notches. The settling time of the ADS1259 is different if START is used to begin conversions or if the ADS1259 is free-running the conversions. These modes are explained in the [Settling Time Using START](#) and [Settling Time While Continuously Converting](#) sections.

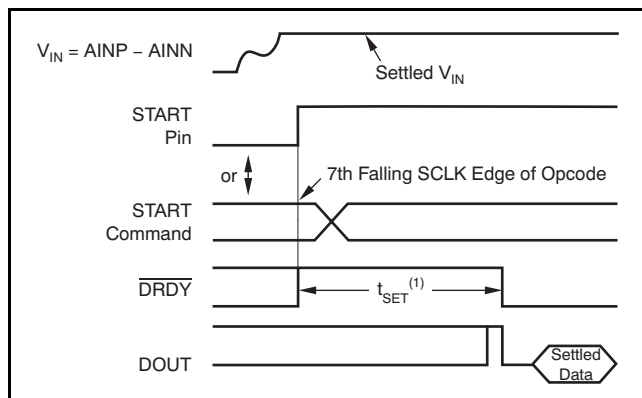

(1) t_{SET} = initial start delay plus the new conversion cycle time.

Figure 53. Data Retrieval Time After START

Settling Time Using START

When START goes high (via pin or command) a delay may be programmed before the conversion filter cycle begins. The programmable delay may be useful to provide time for external circuits (such as after an external signal mux change), before the reading is started. Register bits DELAY[2:0] set the initial delay time as shown in Table 8.

Table 8. Initial START Delay

DELAY[2:0]	$t_{DELAY} (t_{CLK})$	$t_{DELAY} (\mu s)^{(1)}$
000	0	0
001	64	8.68
010	128	17.4
011	256	34.7
100	512	69.4
101	1024	139
110	2048	278
111	4096	556

(1) $f_{CLK} = 7.3728MHz$.

After the programmable delay, the digital filter is reset and a new conversion is started. \overline{DRDY} goes low when data are ready. There is no need to ignore or discard data; the data are completely settled. The total time to perform the first conversion is the sum of the programmable delay time and the settling of the digital filter. That is, the value of Table 8 and Table 9 combined. Figure 53 shows the timing and Table 9 shows the settling time with programmable delay equal to '0'.

Table 9. Settling Time Using START

DATA RATE (SPS)	SETTLING TIME (t_{SET}) (ms) ⁽¹⁾	
	sinc ¹	sinc ²
10	100	200
16.6	60.3	120
50	20.3	40.4
60	17.0	33.7
400	2.85	5.42
1200	1.18	2.10
3600	0.632	0.980
14,400	0.424	0.563

(1) $f_{CLK} = 7.3728MHz$, DELAY[2:0] = 000.

Settling Time While Continuously Converting

If there is a step change on the input signal while continuously converting, the next data represent a combination of the previous and current input signal and should therefore be discarded; see [Figure 54](#) for this step change. [Table 10](#) shows the number of conversion cycles for completely settled data while continuously converting.

Table 10. Settling Time While Continuously Converting DRDY Periods⁽¹⁾

DATA RATE (SPS)	SETTLING TIME (t _{SET}) (Conversions)	
	sinc ¹	sinc ²
10	2	3
16.6	2	3
50	2	3
60	2	3
400	2	3
1200	2	3
3600	3	4
14,400	6	7

(1) Settling time is defined as the number of $\overline{\text{DRDY}}$ periods after the input signal has settled following an input step change. For best data throughput in multiplexed applications, issue a START condition (START pin or Start command) after the input has settled following a multiplexer change; see the [Settling Time Using START](#) section.

OFFSET AND GAIN

The ADS1259 features low offset (40µV, typ) and low gain errors (0.05%, typ). The offset and gain errors can be corrected by sending calibration commands to the ADS1259; see the [Calibration](#) section.

The ADS1259 also features very low offset drift (0.05µV/°C, typ) and very low gain drift (0.5ppm/°C, typ). The offset and gain drift are calculated using the box method, as described by [Equation 6](#) and [Equation 7](#):

$$\text{Offset Drift} = \left[\frac{V_{\text{OFFMAX}} - V_{\text{OFFMIN}}}{\text{Temp Range}} \right] \quad (6)$$

$$\text{Gain Drift} = \left[\frac{\text{GainError}_{\text{MAX}} - \text{GainError}_{\text{MIN}}}{\text{Temp Range}} \right]$$

where:

V_{OFFMAX} , V_{OFFMIN} , $\text{GainError}_{\text{MAX}}$, and $\text{GainError}_{\text{MIN}}$ are the maximum and minimum offset and gain error readings recorded over the Temp Range (–40°C to +105°C) (7)

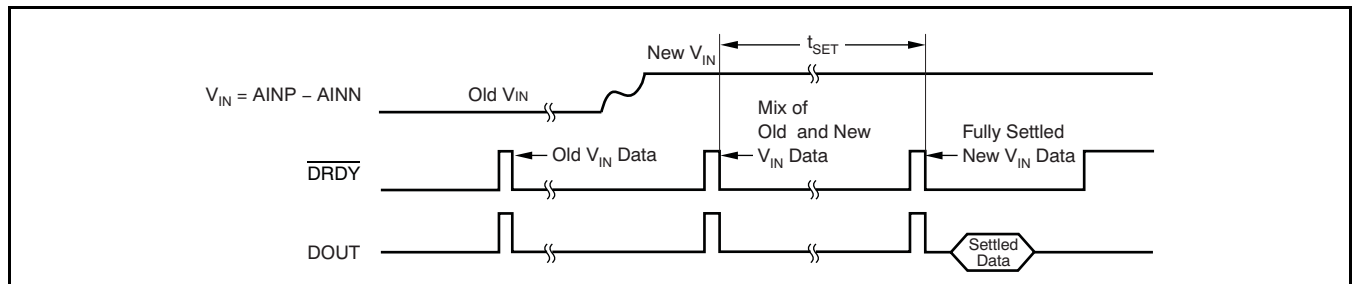

Figure 54. Step Change on V_{IN} while Continuously Converting

OFFSET AND FULL-SCALE CALIBRATION REGISTERS

The conversion data are scaled by offset and gain registers before yielding the final output code. As shown in Figure 55, the output of the digital filter is first subtracted by the offset register (OFC) and then multiplied by the full-scale register (FSC). Equation 8 shows the scaling:

$$\text{Final Output Data} = (\text{Input} - \text{OFC}[2:0]) \times \frac{\text{FSC}[2:0]}{400000\text{h}} \tag{8}$$

The values of the offset and full-scale registers are set by writing to them directly, or they are set by calibration commands.

OFC[2:0] Registers

The offset calibration is a 24-bit word, composed of three 8-bit registers, as shown in Table 13. The offset is in twos complement format with a maximum positive value of 7FFFFFFh and a maximum negative value of 800000h. This value is subtracted from the conversion data. A register value of 000000h has no offset correction (default value). Note that while the offset calibration register value can correct offsets ranging from –FS to +FS (as Table 11 shows), to avoid input overload, the analog inputs cannot exceed 105% full-scale.

Table 11. Offset Calibration Values

OFC REGISTER	FINAL OUTPUT CODE ⁽¹⁾
7FFFFFFh	800001h
000001h	FFFFFFh
000000h	000000h
FFFFFFh	000001h
800001h	7FFFFFFh

(1) Ideal output code excluding noise and inherent offset error.

FSC[2:0] Registers

The full-scale calibration is a 24-bit word, composed of three 8-bit registers, as shown in Table 14. The full-scale calibration value is 24-bit, straight binary, normalized to 1.0 at code 400000h. Table 12 summarizes the scaling of the full-scale register. A register value of 400000h (default value) has no gain correction (gain = 1). Note that while the gain calibration register value corrects gain errors above 1 (gain correction < 1), the full-scale range of the analog inputs cannot exceed 105% full-scale to avoid input overload.

Table 12. Full-Scale Calibration Register Values

FSC REGISTER	GAIN FACTOR
800000h	2.0
400000h	1.0
200000h	0.5
000000h	0

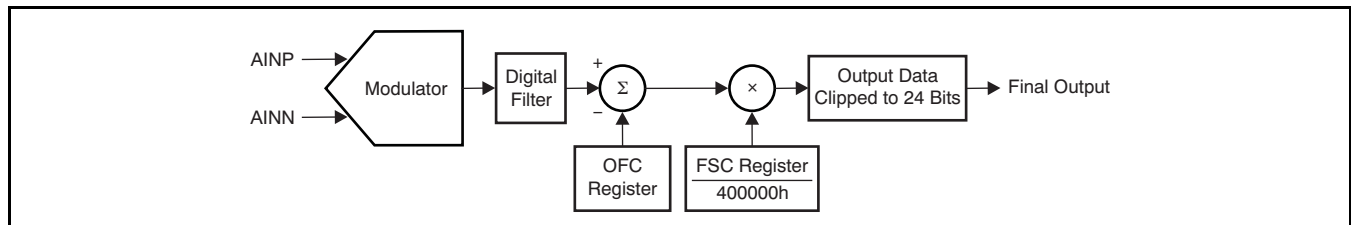

Figure 55. Calibration Block Diagram

Table 13. Offset Calibration Word

REGISTER	BYTE	BIT ORDER							
OFC0	LSB	B7	B6	B5	B4	B3	B2	B1	B0 (LSB)
OFC1	MID	B15	B14	B13	B12	B11	B10	B9	B8
OFC2	MSB	B23 (MSB)	B22	B21	B20	B19	B18	B17	B16

Table 14. Full-Scale Calibration Word

REGISTER	BYTE	BIT ORDER							
FSC0	LSB	B7	B6	B5	B4	B3	B2	B1	B0 (LSB)
FSC1	MID	B15	B14	B13	B12	B11	B10	B9	B8
FSC2	MSB	B23 (MSB)	B22	B21	B20	B19	B18	B17	B16

CALIBRATION

The ADS1259 has commands to correct for system offset and gain errors. Calibration can be performed at any time the ADS1259 and associated circuitry (such as the input amplifier, external reference, power supplies, etc) have stabilized. Options include calibrating after power-up, after temperature changes, or calibration at regular intervals. To calibrate:

- Set the gate control mode (PULSE bit = 0)
- Start the ADS1259 conversions
- Apply the appropriate input to the ADS1259 (zero or full-scale)
- Allow time for the input to completely settle
- Send the OFSCAL (offset calibration) or GANCAL (full-scale calibration) command, as appropriate
- Wait for calibration to complete as given by the time listed in Table 15. $\overline{\text{DRDY}}$ goes low when calibration is complete. The conversion result at this time uses the new offset or full-scale calibration words.

Figure 56 shows the calibration timing. During calibration, do not send commands.

Perform offset calibration prior to the gain calibration.

The internal full-scale calibration word is bypassed during offset calibration. Do not exceed +105% of full-scale range for gain calibration. Note that the out-of-range threshold is unaffected by gain calibration.

Table 15. Calibration Timing

DATA RATE (SPS)	t_{CAL} CALIBRATION TIME (ms)	
	sinc ¹	sinc ²
14400	1.89	2.19
3600	5.43	6.15
1200	14.9	16.7
400	43.2	48.4
60	284	318
50	341	380
16.6	1020	1140
10	1700	1900

1. $f_{\text{CLK}} = 7.3728\text{MHz}$.

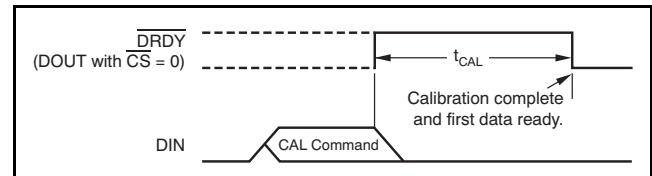

Figure 56. Calibration Timing

SERIAL INTERFACE

The SPI-compatible serial interface consists of four signals: \overline{CS} , SCLK, DIN, and DOUT or three signals, in which case \overline{CS} may be tied low. The interface is used to read conversion data, configure registers, and control the ADS1259 operation.

SERIAL COMMUNICATION

The ADS1259 communications occur by clocking commands into the device (on DIN) and reading register and conversion data (on DOUT). The SCLK input is used to clock the data into and out of the device. \overline{CS} disables the ADS1259 serial port but otherwise does not affect the ADC operation. The communication protocol to the ADS1259 is half-duplex. That is, data are transmitted to and from the device one direction at a time.

Communications to and from the ADS1259 occurs on 8-bit boundaries. If an unintentional SCLK transition should occur (such as from a possible noise spike), the ADS1259 serial port may not respond properly. The port can be reset by one of the following ways:

1. Take \overline{CS} high and then low to reset the interface
2. Hold SCLK low for $2^{16} f_{CLK}$ cycles to reset the interface
3. Take $\overline{RESET/PWDN}$ low and back high to overall reset the device
4. Cycle the power supplies to overall reset the device

CHIP SELECT (\overline{CS})

The chip select (\overline{CS}) selects the ADS1259 for SPI communication. To select the device, pull \overline{CS} low. \overline{CS} must remain low for the duration of the serial communication. When \overline{CS} is taken high, the serial interface is reset, input commands are ignored, and DOUT enters a high-impedance state. If the ADS1259 does not share the serial bus with another device, \overline{CS} may be tied low. Note that \overline{DRDY} remains active when \overline{CS} is high.

SERIAL CLOCK (SCLK)

The serial clock (SCLK) is a Schmitt-triggered input used to clock data into and out of the ADS1259. Even though the input is relatively noise immune, it is recommended to keep SCLK as clean as possible to prevent glitches from accidentally shifting the data. If SCLK is held low for $2^{16} f_{CLK}$ periods, the serial interface resets. After reset the next communication cycle can be started. The timeout can be used to recover communication when the serial interface is interrupted. The SPI timeout is enabled by register bit SPI. When the serial interface is idle, hold SCLK low.

DATA INPUT (DIN)

DIN is the input data pin and is used with SCLK to send data to the ADS1259 (opcode commands and register data). The device latches input data on the falling edge of SCLK.

DATA OUTPUT (DOUT)

DOUT is the output data pin and is used with SCLK to read conversion and register data from the ADS1259. In addition to providing data output, in RDATAAC mode DOUT indicates when data are ready. Data are ready when DOUT transitions low. In this manner, DOUT functions the same as \overline{DRDY} (with $\overline{CS} = 0$), as shown in Figure 57. When reading data, the data are shifted out on the rising edge of SCLK. DOUT is in a 3-state condition when \overline{CS} is high.

DATA READY (\overline{DRDY})

\overline{DRDY} is an output that indicates when conversion data are available for reading (falling edge active). \overline{DRDY} is asserted on an output pin and also a register bit. To poll the \overline{DRDY} register bit, set the stop read data continuous mode and then read the CONFIG2 register. When the \overline{DRDY} bit is low, data can be read. The data read operation must complete within $20 f_{CLK}$ cycles of the next \overline{DRDY} falling edge. After power-on or after reset, \overline{DRDY} defaults high.

When reading data in Gate Control mode, \overline{DRDY} is reset high on the first SCLK rising edge. If data are not retrieved, \overline{DRDY} pulses high during the new data update time, as shown in Figure 57. Do not retrieve data during this time as the data are invalid.

In Pulse Control mode, \overline{DRDY} remains low until a new conversion is started. The previous conversion data may be read $20 t_{CLK}$ prior to the \overline{DRDY} falling edge.

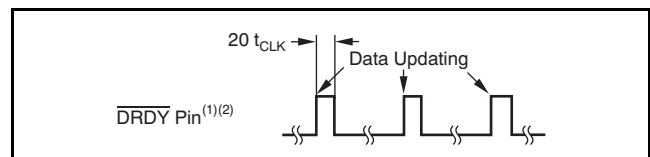

(1) DOUT functions in the same manner as the \overline{DRDY} pin if \overline{CS} is low and in the RDATAAC mode.

(2) The \overline{DRDY} bit functions in the same manner as the \overline{DRDY} pin (SDATAAC mode only).

Figure 57. \overline{DRDY} and DOUT With No Data Retrieval

DATA FORMAT

The ADS1259 outputs 24 bits of conversion data in binary two's complement format, MSB first. The data LSB has a weight of $V_{REF}/(2^{23} - 1)$. A positive full-scale input produces an output code of 7FFFFFFh and the negative full-scale input produces an output code of 800000h. The output clips at these codes for signals that exceed full-scale. Table 16 summarizes the ideal output codes for different input signals.

Table 16. Ideal Output Code versus Input Signal

DIFFERENTIAL INPUT SIGNAL V_{IN} (AINP – AINN)	IDEAL OUTPUT CODE ⁽¹⁾
$\geq V_{REF}$	7FFFFFFh
$\frac{+V_{REF}}{(2^{23} - 1)}$	000001h
0	000000h
$\frac{-V_{REF}}{(2^{23} - 1)}$	FFFFFFh
$\leq -V_{REF} \left[\frac{2^{23}}{2^{23} - 1} \right]$	800000h

(1) Excludes effects of noise, linearity, offset, and gain errors.

DATA INTEGRITY

Data readback integrity is augmented by a checksum byte and redundant data read capability. The checksum byte is the sum of three data conversion bytes, offset by 9Bh. Additionally, the data conversion bytes may be read multiple times by continuing to shift data past the initial read of 24 bits (32 bits if checksum is enabled).

DATA CHECKSUM BYTE AND FLAG BIT

An optional checksum byte can be appended to the conversion data bytes. The checksum makes the data word length four bytes in length instead of three. The checksum byte is enabled by the register bit CHKSUM. The checksum itself is the least significant byte sum of the three conversion data bytes, offset by 9Bh. Note that the checksum byte option only applies to the readback conversion data, not to register data. The checksum is either seven bits or eight bits, depending if the FLAG register bit is enabled. If the FLAG bit is enabled the checksum is seven bits, with bit 7 replaced by the out-of-range flag. Figure 58 and Table 17 describe the combinations of the FLAG and CHKSUM register bits.

Checksum = MSB data byte + Mid data byte + LSB data byte + 9Bh.

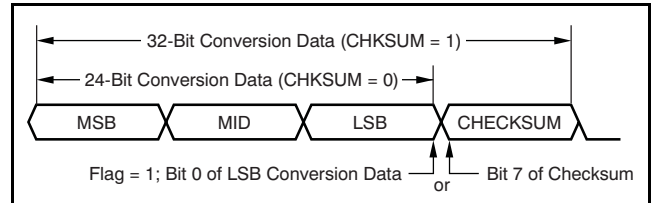

Figure 58. Checksum Byte and Out-of-Range Flag

Table 17. Checksum Byte and Over-Range Flag

FLAG REGISTER BIT	CHKSUM REGISTER BIT	DESCRIPTION
0	0	No checksum byte, no out-of-range flag
0	1	8-bit checksum byte, no out-of-range flag
1	0	No checksum byte, out-of-range flag replaces LSB (bit 0) of conversion data
1	1	7-bit checksum byte, out-of-range replaces MSB (bit 7) of checksum byte.

DATA RETRIEVAL

New conversion data are available when \overline{DRDY} goes low. Read the data within 20 f_{CLK} cycles of the next \overline{DRDY} falling edge or the data are incorrect. Do not read data during this interval. The conversion data may be read in two ways: Data Read in Continuous mode and Data Read in Stop Continuous mode.

Data Read Operation in Continuous Mode

In Read Data Continuous mode the conversion data may be shifted out directly without the need of the data read command. When \overline{DRDY} (and DOUT, if \overline{CS} is low) asserts low, the conversion data are ready. The data are shifted out on DOUT on the rising edges of SCLK, with the most significant bit (MSB) clocked out first. In Gate Convert Mode, \overline{DRDY} returns to high on the first falling edge of SCLK. In Pulse Convert mode, \overline{DRDY} remains low until a new conversion starts.

As shown in Figure 60, the conversion data consist of three or four bytes (data MSB first), depending on whether the checksum byte is included. The data may be read multiple times by continuing to shift the data. The data read operation must be completed with 20 f_{CLK} cycles of next \overline{DRDY} falling edge.

The Read Data Continuous mode is cancelled by sending the Stop Read Data Continuous command (SDATAC). This operation occurs simultaneously with ADC conversion data on DOUT which can be ignored. Once the SDATAC command is sent, other commands may be sent to the ADS1259. Observe the SCLK and \overline{DRDY} timing requirements, when reading data in this mode, as shown in Figure 59 and Table 18.

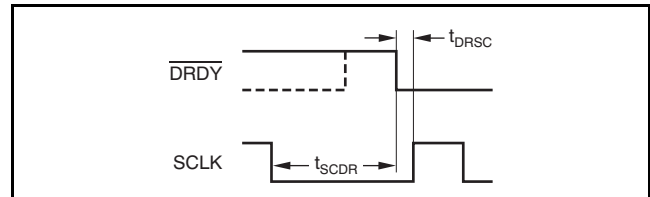
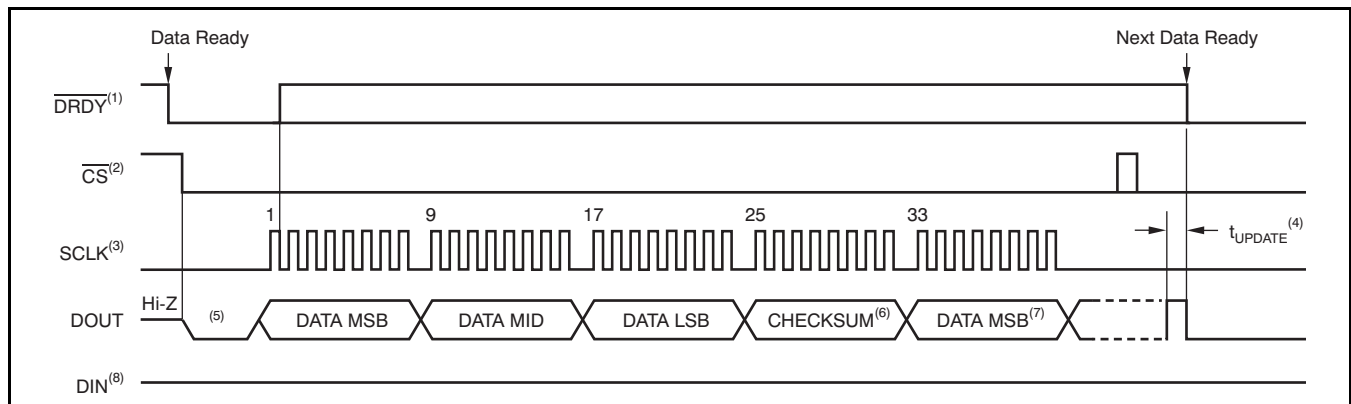

Figure 59. SCLK to \overline{DRDY} Timing

Table 18. SCLK and \overline{DRDY} Timing Characteristics for Figure 57

SYMBOL	DESCRIPTION	MIN	UNIT
$t_{SCDR}^{(1)}$	SCLK low before \overline{DRDY} low ⁽¹⁾	20	t_{CLK}
$t_{DRSC}^{(1)}$	\overline{DRDY} falling edge to SCLK rising edge ⁽¹⁾	40	ns

(1) These requirements apply only to reading conversion data in RDATA mode.



- (1) In Gate Convert Conversion mode, \overline{DRDY} returns to high on the first falling edge of SCLK. In Pulse Convert mode, \overline{DRDY} remains low until the next conversion is started.
- (2) \overline{CS} may be held low. If \overline{CS} is low, DOUT asserts low with \overline{DRDY} .
- (3) Data are updated on the rising edge of SCLK. DOUT is low until the first rising edge of SCLK.
- (4) $t_{UPDATE} = 20/f_{CLK}$. Do not read data during this time.
- (5) During this interval, DOUT follows \overline{DRDY} .
- (6) Optional data checksum byte.
- (7) Optional repeat of previous conversion data.
- (8) Hold DIN low, except for transmission of the SDATAC (STOP Read Data Continuous command).

Figure 60. Data Read Operation in Continuous Mode

Data Read Operation in Stop Continuous Mode

In Stop Read Data Continuous mode, a read data command (RDATA) must be sent for each new data read operation. New conversion data are ready when $\overline{\text{DRDY}}$ falls low or the $\overline{\text{DRDY}}$ register bit transitions low. The data read operation may then occur. The read data command must be sent at least $20 f_{\text{CLK}}$ cycles before the $\overline{\text{DRDY}}$ falling edge or the data are incorrect. Do not the read data command during this time.

As shown in Figure 61, after sending the RDATA command the data are shifted out on DOUT on the rising edges of SCLK. The MSB is clocked out on the first rising edge of SCLK. In Gate Control mode, $\overline{\text{DRDY}}$ returns to high on the first falling edge of SCLK. In Pulse Control mode, $\overline{\text{DRDY}}$ remains low until a new conversion is started.

The conversion data consist of three or four bytes (MSB first), depending on whether the checksum byte is included. The data may be read multiple times by continuing to shift the data.

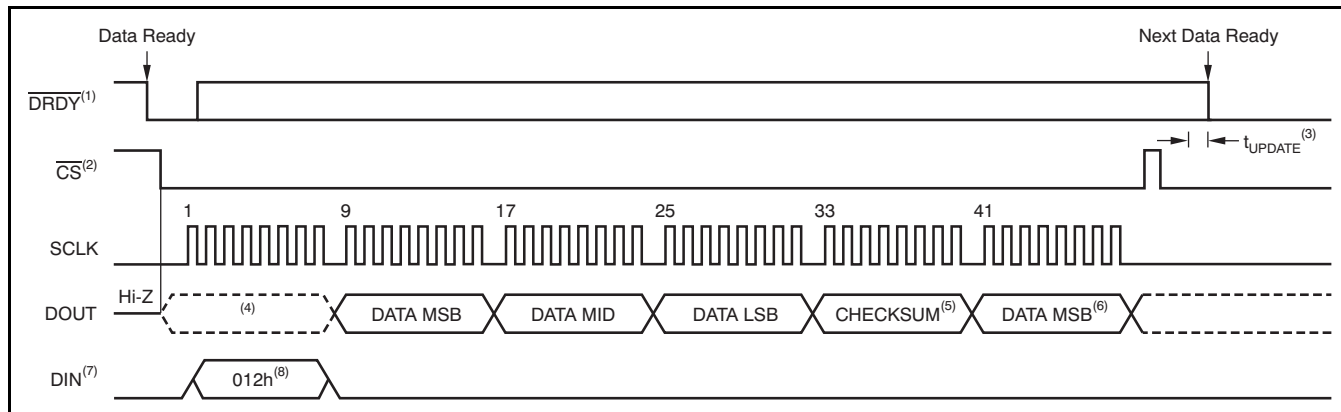

(1) In Gate Control mode, $\overline{\text{DRDY}}$ returns to high on the first falling edge of SCLK. In Pulse Control mode, $\overline{\text{DRDY}}$ remains low until the next conversion is started. The $\overline{\text{DRDY}}$ pin or $\overline{\text{DRDY}}$ register bit can also be polled to determine when data are ready.

(2) $\overline{\text{CS}}$ may be held low.

(3) $t_{\text{UPDATE}} = 20/f_{\text{CLK}}$. Do not issue the Read Data opcode during this time.

(4) During this interval, DOUT does not follow $\overline{\text{DRDY}}$ (stop continuous mode).

(5) Optional conversion data checksum.

(6) Optional repeat of previous conversion data.

(7) DIN data are latched on the falling edge of SCLK. Data are output on the rising edges of SCLK.

(8) Read Data command = 012h.

Figure 61. Data Read Operation in STOP Continuous Mode

COMMAND DEFINITIONS

The commands summarized in [Table 19](#) control and configure the operation of the ADS1259. The commands are stand-alone, except for the register read and register write operations which require a second command byte plus data. CS can be taken high or held low between opcode commands but must stay low for the entire command operation. Note that the Read Data Continuous mode must be cancelled by the Stop Read Data Continuous mode opcode (SDATAC) before sending further commands.

Table 19. Command Definitions⁽¹⁾

COMMAND	TYPE	DESCRIPTION	FIRST OPCODE BYTE	SECOND OPCODE BYTE
WAKEUP	Control	Wake up from SLEEP mode	0000 001x (02h or 03h) ⁽²⁾	
SLEEP	Control	Begin SLEEP mode	0000 010x (04h or 05h) ⁽²⁾	
RESET	Control	Reset to power-up values	0000 011x (06h or 07h) ⁽²⁾	
START	Control	START conversion	0000 100x (08h or 09h) ⁽²⁾	
STOP	Control	STOP conversion	0000 101x (0Ah or 0Bh) ⁽²⁾	
RDATAC	Control	Set Read Data Continuous mode	0001 0000 (10h)	
SDATAC	Control	Stop Read Data Continuous mode	0001 0001 (11h)	
RDATA	Data	Read data by opcode	0001 001x (12h or 13h) ⁽²⁾	
RREG	Register	Read <i>nnnn</i> register at address <i>rrrr</i>	0010 <i>rrrr</i> (20h + 0000 <i>rrrr</i>)	0000 <i>nnnn</i> (00h + <i>nnnn</i>)
WREG	Register	Write <i>nnnn</i> register at address <i>rrrr</i>	0100 <i>rrrr</i> (40h + 0000 <i>rrrr</i>)	0000 <i>nnnn</i> (00h + <i>nnnn</i>)
OFSCAL	Calibration	Offset calibration	0001 1000 (18h)	
GANCAL	Calibration	Gain calibration	0001 1001 (19h)	

(1) *nnnn* = number of registers to be read/written – 1. For example, to read/write 3 registers, set *nnnn* = 2 (0010).

rrrr = starting register address for read/write opcodes.

(2) These commands are decoded on the seventh bit of the opcode. The eighth bit is a *don't care* bit. All other commands are decoded on the eighth bit.

WAKEUP: Exit SLEEP Mode

Description: This command exits the low-power SLEEP mode; see the [SLEEP Mode](#) section.

SLEEP: Enter SLEEP Mode

Description: This command enters the low-power SLEEP mode. See the [SLEEP Mode](#) section.

RESET: Reset Registers to Default Values

Description: This command resets the digital filter cycle and returns all register settings to the default values.

START: Start Conversions

Description: This command starts data conversions. If PULSE bit = 1, then a single conversion is performed. If PULSE bit = 0, then conversions continue until the STOP command is sent. Tie the START pin low to control conversions by command.

STOP: Stop Conversions

Description: This command stops conversions. When the STOP command is sent, the conversion in progress completes and further conversions are stopped. If conversions are already stopped, this command has no effect. See the [Conversion Control](#) section. Tie the START pin low to control conversions by command.

RDATAC: Read Data Continuous

Description: This command enables the Read Data Continuous mode (default). See the [Read Data Continuous Mode](#) section for details. Disable this mode with the SDATAC command before sending other commands.

SDATAC: Stop Read Data Continuous

Description: This command cancels the Read Data Continuous mode.

RDATA: Read Data

Description: Issue this command opcode after $\overline{\text{DRDY}}$ goes low to read the conversion result (in Stop Read Data Continuous mode). See the *Read Data Mode* section for more details.

RREG: Read from Registers

Description: These opcode bytes read register data. The Register Read command is a two-byte opcode followed by the output of the register data. The first byte contains the command opcode and the register address. The second byte of the opcode specifies the number of registers to read – 1.

First opcode byte: 0010 *rrrr*, where *rrrr* is the starting register address.

Second opcode byte: 0000 *nnnn*, where *nnnn* is the number of registers to read.

The 17th SCLK rising edge of the operation clocks out the MSB of the first register.

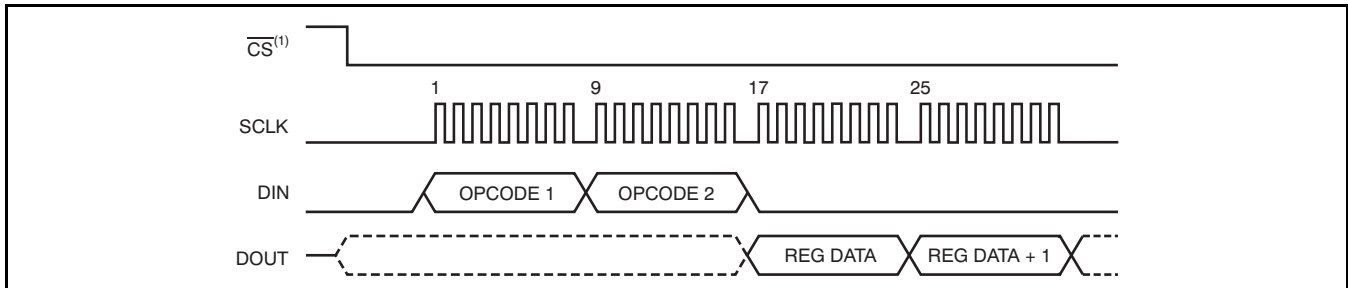

(1) $\overline{\text{CS}}$ may be tied low.

**Figure 62. RREG Command Example: Read Two Registers Starting from Register 00h (CONFIG0)
(OPCODE 1 = 0010 0000, OPCODE 2 = 0000 0001)**

WREG: Write to Register

Description: These two opcode bytes write register data. The Register Write command is a two-byte opcode followed by the register data. The first byte contains the command opcode and the register address. The second byte of the opcode specifies the number of registers to write – 1.

First opcode byte: 0100 *rrrr*, where *rrrr* is the starting register address.

Second opcode byte: 0000 *nnnn*, where *nnnn* is the number of registers to write

After the opcode bytes, the register data follows (in MSB-first format).

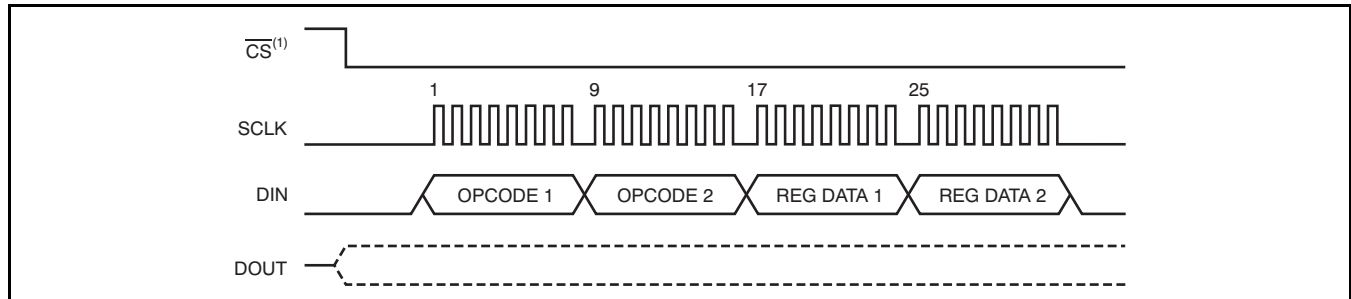

(1) \overline{CS} may be tied low.

**Figure 63. WREG Command Example: Write Two Registers Starting from 00h (CONFIG0)
(OPCODE 1 = 0100 0000, OPCODE 2 = 0000 0001)**

OFSCAL: Offset Calibration

Description: This command performs an offset calibration. Apply a zero signal and allow the input to stabilize before sending the command; see the [Calibration](#) section for more details.

GANCAL: Gain Calibration

Description: This command performs a gain calibration. Apply a full-scale signal and allow the input to stabilize before sending the command; see the [Calibration](#) section for more details.

REGISTER MAP

The operation of the ADS1259 is controlled through a set of registers. Collectively, the registers contain all the information needed to configure the part, such as data rate, calibration, etc. [Table 20](#) shows the register map.

Table 20. Register Map

ADDRESS	REGISTER	RESET VALUE	BIT 7	BIT 6	BIT 5	BIT 4	BIT 3	BIT 2	BIT 1	BIT 0
0h	CONFIG0	10XX0101b	1	0	ID1	ID0	0	RBIAS	0	SPI
1h	CONFIG1	00001000b	FLAG	CHKSUM	0	SINC2	EXTREF	DELAY2	DELAY1	DELAY0
2h	CONFIG2	XX000000b	DRDY	EXTCLK	SYNCOUT	PULSE	0	DR2	DR1	DR0
3h	OFC0	00000000b	OFC07	OFC06	OFC05	OFC04	OFC03	OFC02	OFC01	OFC00
4h	OFC1	00000000b	OFC15	OFC14	OFC13	OFC12	OFC11	OFC10	OFC09	OFC08
5h	OFC2	00000000b	OFC23	OFC22	OFC21	OFC20	OFC19	OFC18	OFC17	OFC16
6h	FSC0	00000000b	FSC07	FSC06	FSC05	FSC04	FSC03	FSC02	FSC01	FSC00
7h	FSC1	00000000b	FSC15	FSC14	FSC13	FSC12	FSC11	FSC10	FSC09	FSC08
8h	FSC2	01000000b	FSC23	FSC22	FSC21	FSC20	FSC19	FSC18	FSC17	FSC16

CONFIG0: CONFIGURATION REGISTER 0 (Address = 0h)

7	6	5	4	3	2	1	0
1	0	ID1	ID0	0	RBIAS	0	SPI

Reset value = 10XX0101b.

Bit 7 Reserved (read-only)

Always returns '1'.

Bit 6 Reserved (read-only)

Always returns '0'.

Bits 5-4 ID[1:0]: Factory-programmed identification bits (read-only)

(Note that these bits may change without notification.)

Bit 3 Reserved

Always write '0'.

Bit 2 RBIAS: Internal reference bias

0 = Internal reference bias disabled

1 = Internal reference bias enabled (default)

Bit 1 Reserved

Always write '0'.

Bit 0 SPI: SCLK timeout of SPI interface

0 = SPI timeout disabled

1 = SPI timeout enabled (default), when SCLK is held low for 2¹⁶ clock cycles

CONFIG1: CONFIGURATION REGISTER 1 (Address = 1h)

7	6	5	4	3	2	1	0
FLAG	CHKSUM	0	SINC2	EXTREF	DELAY2	DELAY1	DELAY0

Reset value = 00001000b.

- Bit 7 FLAG: Out-of-range flag**
 0 = Disabled (default)
 1 = Enabled: replaces bit 24 (LSB) of the conversion data with the out-of-range bit; if the CHKSUM byte is enabled, bit 7 of the checksum byte

- Bit 6 CHKSUM: Checksum**
 0 = Disabled (default)
 1 = Conversion data checksum byte included in readback

- Bit 5 Reserved**
 Always write '0'.

- Bit 4 SINC2: Digital filter mode**
 0 = sinc¹ filter (default)
 1 = sinc² filter

- Bit 3 EXTREF: Reference select**
 0 = Internal
 1 = External (default)

- Bits 2-0 DELAY[2:0]: START conversion delay**
 000 = No delay (default)
 001 = 64 t_{CLK}
 010 = 128 t_{CLK}
 011 = 256 t_{CLK}
 100 = 512 t_{CLK}
 101 = 1024 t_{CLK}
 110 = 2048 t_{CLK}
 111 = 4096 t_{CLK}

CONFIG2: CONFIGURATION REGISTER 2 (Address = 2h)

7	6	5	4	3	2	1	0
DRDY	EXTCLK	SYNCOUT	PULSE	0	DR2	DR1	DR0

Reset value = XX000000b.

Bit 7 **DRDY: Data ready (read-only)**

This bit duplicates the state of the DRDY pin. Poll this bit to indicate that data are ready. When DRDY is low, data are ready.

Bit 6 **EXTCLK: Clock source (read-only)**

0 = Device clock source is internal oscillator
 1 = Device clock source is external clock
 Note that the ADS1259 selects the clock source automatically.

Bit 5 **SYNCOUT: SYNCOUT clock enable**

0 = SYNCOUT disabled (default)
 1 = SYNCOUT enabled
 Note that if disabled, the output is driven low.

Bit 4 **PULSE: Conversion Control mode select**

0 = Gate Control mode (default)
 1 = Pulse Control mode

Bit 3 **Reserved**

Always write '0'

Bits 2-0 **DR[2:0] Data rate setting**

000 = 10SPS (default)
 001 = 16.6SPS
 010 = 50SPS
 011 = 60SPS
 100 = 400SPS
 101 = 1200SPS
 110 = 3600SPS
 111 = 14400SPS
 NOTE: $f_{CLK} = 7.3728\text{MHz}$

OFC0: OFFSET CALIBRATION BYTE 0, LEAST SIGNIFICANT BYTE (Address = 3h)

7	6	5	4	3	2	1	0
OFC07	OFC06	OFC05	OFC04	OFC03	OFC02	OFC01	OFC00

Reset value = 00000000b.

OFC1: OFFSET CALIBRATION BYTE 1 (Address = 4h)

7	6	5	4	3	2	1	0
OFC15	OFC14	OFC13	OFC12	OFC11	OFC10	OFC09	OFC08

Reset value = 00000000b.

OFC2: OFFSET CALIBRATION BYTE 2, MOST SIGNIFICANT BYTE (Address = 5h)

7	6	5	4	3	2	1	0
OFC23	OFC22	OFC21	OFC20	OFC19	OFC18	OFC17	OFC16

Reset value = 00000000b.

FSC0: FULL-SCALE CALIBRATION BYTE 0, LEAST SIGNIFICANT BYTE (Address = 6h)

7	6	5	4	3	2	1	0
FSC07	FSC06	FSC05	FSC04	FSC03	FSC02	FSC01	FSC00

Reset value = 00000000b.

FSC1: FULL-SCALE CALIBRATION BYTE 1 (Address = 7h)

7	6	5	4	3	2	1	0
FSC15	FSC14	FSC13	FSC12	FSC11	FSC10	FSC09	FSC08

Reset value = 00000000b.

FSC2: FULL-SCALE CALIBRATION BYTE 2, MOST SIGNIFICANT BYTE (Address = 8h)

7	6	5	4	3	2	1	0
FSC23	FSC22	FSC21	FSC20	FSC19	FSC18	FSC17	FSC16

Reset value = 01000000b.

BASIC CONNECTION

The ADS1259 basic connections are shown in Figure 64. The diagram shows the ADS1259 operating with an internal oscillator and with internal reference. Dual ±2.5V analog power supplies are also shown. Pins 6-9 are the SPI port connection. The remaining digital I/O pins connect to the controller I/O. Note that the minimum configuration of the digital I/O may include only SCLK, DIN, and DOUT.

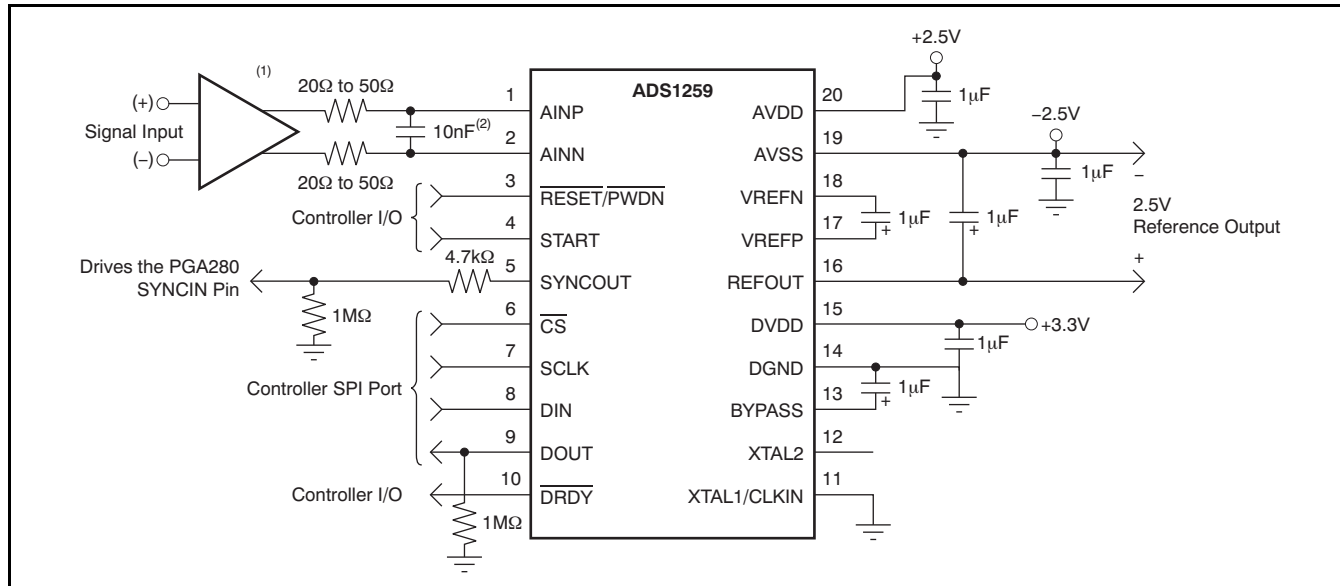

(1) It is recommended to buffer the ADS1259 inputs. The output isolation resistors may be incorporated within the amplifier feedback loop.

(2) Low distortion C0G or film capacitor recommended.

Figure 64. ADS1259 Basic Connection Diagram

LAYOUT

Place the input buffer and input decoupling capacitors close to the ADS1259 inputs. The bypass capacitors for power-supply and reference decoupling should also be placed close to the device. In some cases, it may be necessary to use a split ground plane in which digital return currents of external components are routed away from the ADS1259. In this case, connect the grounds at the power supply.

CONFIGURATION GUIDE

Configuration of the ADS1259 involves configuring the device hardware (power supply, I/O pins, etc) and device register settings. The registers are configured by commands sent via the device SPI port.

Power Supplies

The ADS1259 analog section operates either with a single +5V or dual ±2.5V supplies. The digital section operates from +2.7V to +5V. The digital and analog power supplies may be tied together (+5V only).

Reference

Select either the internal reference or an external reference for the ADS1259 (see the Reference section). The default is external reference. Figure 64 depicts the internal reference connection.

Clock

Choose the desired clock source (see the Clock Source section). Figure 64 depicts the internal clock operation.

SYNCOUT Pin

Connect the SYNCOUT pin to the SYNCIN pin of the PGA280, using a 4.7kΩ series resistor (placed close to the ADS1259). The 1MΩ pull-down resistor is required when the ADS1259 is in power-down mode.

RESET/PWDN Pin

This pin must be high in normal operation. If it is desired to completely power down the device, or to have a hardware reset control, then connect this pin to a controller. If these functions are not needed, tie the pin high. (Note that the device can both be reset and SLEEP mode engaged by commands.)

START Pin

If it is desired to control conversions by pin, connect this line to the controller. Otherwise, this line can be tied high to free-run conversions. The conversions can also be controlled by software commands. In this case, tie the START pin low.

DRDY Pin

DRDY is an output that indicates when data are ready for readback. Note that the DOUT pin (and also the DRDY register bit) indicates when data are ready as well, so DRDY connection to a controller is optional.

CS Pin

If the ADS1259 is a single device connected to the SPI bus, then CS can be tied low. Otherwise, for applications where the ADS1259 shares the bus with another device, CS must be connected.

DOUT Pin

When the ADS1259 SPI is deselected ($\overline{CS} = 1$), the DOUT pin is in 3-state mode. A pull-down resistor may be necessary to prevent floating the controller input pin.

Miscellaneous Digital I/O

Avoid ringing on the digital inputs and outputs. Resistors in series with the trace driving end helps to reduce ringing by controlling impedances.

SOFTWARE GUIDE

After the power supplies have fully established, allow a minimum of 2^{16} system clocks before beginning communication to the device. The registers can then be configured by commands via the SPI port. The following steps detail a suggested procedure to initialize the ADS1259.

1. Send the SDATAC command <11h>. This command cancels the RDATAAC mode. RDATAAC mode must be cancelled before the register write commands.
2. Send the register write command. The following example shows the register write as a block of nine bytes, starting at register 0 (CONFIG0).

BYTES	DATA	OPERATION
1, 2	01000000, 00001000	Write register opcode bytes, starting at address 0, 9-byte block
3	00000101	CONFIG0; register data, bias the reference, SPI timeout
4	01010000	CONFIG1; checksum enabled, sinc ² filter selection, internal reference
5	00000011	CONFIG2; Gate Convert mode, 60SPS
6, 7, 8	00000000, 00000000, 00000000	OFC[2:0]; 3 bytes for offset, no offset correction
9, 10, 11	00000000, 00000000, 01000000	FSC[2:0]; 3 bytes for gain, no full-scale correction

3. Optional readback verification of the register data

READ register command: <20h>, <08>

The nine bytes of readback data that follow represent the nine register bytes.

4. Take the START pin high or send the START command to start conversions.

5. Optionally, send the RDATA command <10h>. This permits reading of conversion data without the need of the read data command. Otherwise, the read data opcode must be sent to read each conversion result.

6. When the $\overline{\text{DRDY}}$ pin or the DRDY bit goes low, or when DOUT transitions low, read the data.

PGA280 APPLICATION

Figure 65 shows the ADS1259 connected to the PGA280. The PGA280 is a programmable gain, fully-differential instrumentation amplifier that is ideally suited to drive the ADS1259. The amplifier features $\pm 5\text{V}$ to $\pm 18\text{V}$ supply input section that accepts wide ranging signal levels and features a +5V output section that matches the ADS1259 low-voltage inputs. The ADS1259 +2.5V REFOUT drives the PGA280 VOXM pin to level shift the signal.

The ADS1259 provides a clock output (SYNCOUT) that drives the PGA280 (GPIO6) chopping clock input. An optional extended $\overline{\text{CS}}$ ($\overline{\text{ECS}}$) function feature of the PGA280 (GPIO0) allows use of one $\overline{\text{CS}}$ to alternately select each device for SPI communication. Additionally, the optional BUFA trigger output of the PGA280 (GPIO5) starts the ADS1259 conversions. The trigger can be delayed to occur after an input multiplexer change. The delay allows settling of the PGA280 before the ADC conversion begins.

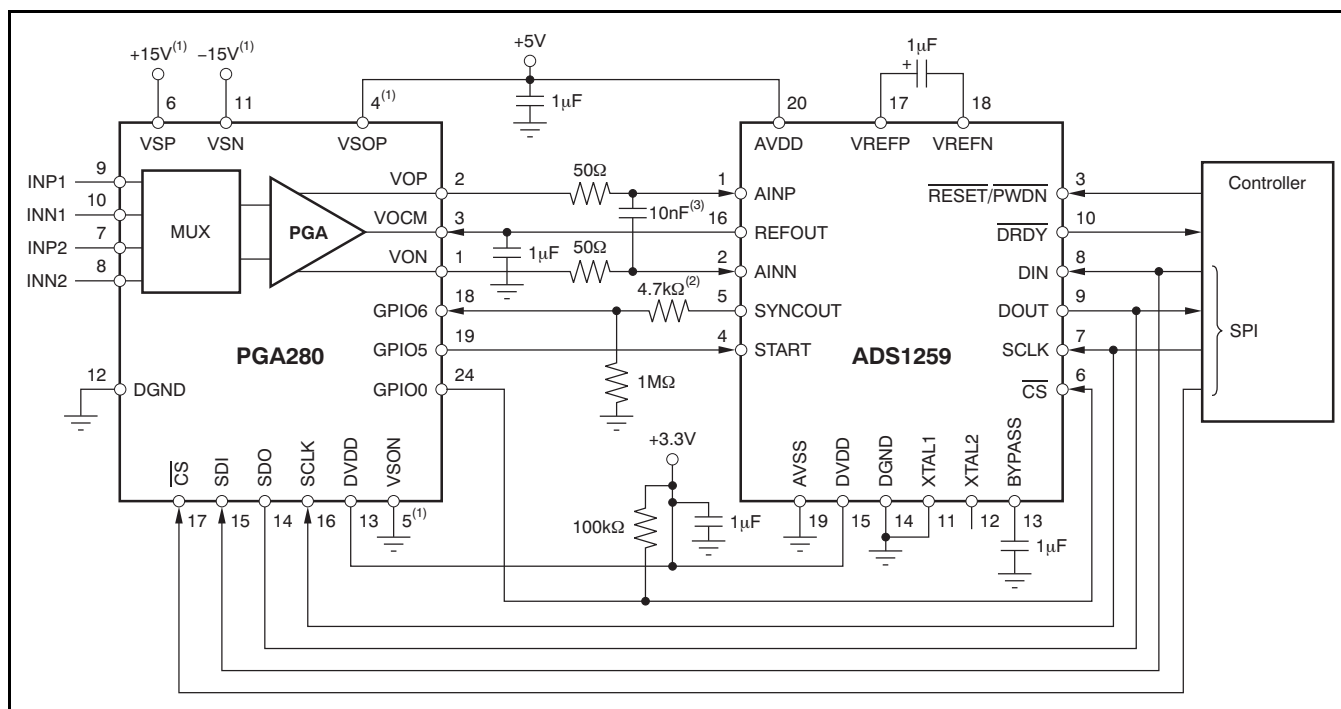

(1) Refer to the PGA280 product data sheet for power-supply bypassing recommendations.

(2) Locate this resistor as close as possible to pin 5 of the ADS1259.

(3) COG or film capacitor.

Figure 65. PGA280 Driving the ADS1259

REVISION HISTORY

NOTE: Page numbers for previous revisions may differ from page numbers in the current version.

Changes from Revision C (March 2010) to Revision D	Page
• Added Internal Voltage Reference, <i>Long-term stability</i> parameter to Electrical Characteristics table	3
• Added Internal Voltage Reference, <i>Thermal hysteresis</i> parameter and footnote 11 to Electrical Characteristics table	3
• Added Figure 31	11
• Added <i>Thermal Hysteresis</i> subsection to <i>Reference</i> section	17

Changes from Revision B (January 2010) to Revision C	Page
• Changed ADS1259B and ADS1259 Internal Voltage Reference, <i>Accuracy</i> parameter in the Electrical Characteristics	3
• Changed ADS1259 Internal Voltage Reference, <i>Temperature drift</i> parameter in the Electrical Characteristics	3
• Added Figure 23 , ADS1259 internal reference voltage versus temperature graph	10
• Added <i>PGA280 Application</i> section	41

PACKAGING INFORMATION

Orderable Device	Status (1)	Package Type	Package Drawing	Pins	Package Qty	Eco Plan (2)	Lead finish/ Ball material (6)	MSL Peak Temp (3)	Op Temp (°C)	Device Marking (4/5)	Samples
ADS1259BIPW	ACTIVE	TSSOP	PW	20	70	RoHS & Green	NIPDAU	Level-1-260C-UNLIM	-40 to 105	ADS1259B	Samples
ADS1259BIPWR	ACTIVE	TSSOP	PW	20	2000	RoHS & Green	NIPDAU	Level-1-260C-UNLIM	-40 to 105	ADS1259B	Samples
ADS1259IPW	ACTIVE	TSSOP	PW	20	70	RoHS & Green	NIPDAU	Level-1-260C-UNLIM	-40 to 105	ADS1259	Samples
ADS1259IPWR	ACTIVE	TSSOP	PW	20	2000	RoHS & Green	NIPDAU	Level-1-260C-UNLIM	-40 to 105	ADS1259	Samples

(1) The marketing status values are defined as follows:

ACTIVE: Product device recommended for new designs.

LIFEBUY: TI has announced that the device will be discontinued, and a lifetime-buy period is in effect.

NRND: Not recommended for new designs. Device is in production to support existing customers, but TI does not recommend using this part in a new design.

PREVIEW: Device has been announced but is not in production. Samples may or may not be available.

OBSOLETE: TI has discontinued the production of the device.

(2) **RoHS:** TI defines "RoHS" to mean semiconductor products that are compliant with the current EU RoHS requirements for all 10 RoHS substances, including the requirement that RoHS substance do not exceed 0.1% by weight in homogeneous materials. Where designed to be soldered at high temperatures, "RoHS" products are suitable for use in specified lead-free processes. TI may reference these types of products as "Pb-Free".

RoHS Exempt: TI defines "RoHS Exempt" to mean products that contain lead but are compliant with EU RoHS pursuant to a specific EU RoHS exemption.

Green: TI defines "Green" to mean the content of Chlorine (Cl) and Bromine (Br) based flame retardants meet JS709B low halogen requirements of <=1000ppm threshold. Antimony trioxide based flame retardants must also meet the <=1000ppm threshold requirement.

(3) MSL, Peak Temp. - The Moisture Sensitivity Level rating according to the JEDEC industry standard classifications, and peak solder temperature.

(4) There may be additional marking, which relates to the logo, the lot trace code information, or the environmental category on the device.

(5) Multiple Device Markings will be inside parentheses. Only one Device Marking contained in parentheses and separated by a "-" will appear on a device. If a line is indented then it is a continuation of the previous line and the two combined represent the entire Device Marking for that device.

(6) Lead finish/Ball material - Orderable Devices may have multiple material finish options. Finish options are separated by a vertical ruled line. Lead finish/Ball material values may wrap to two lines if the finish value exceeds the maximum column width.

Important Information and Disclaimer: The information provided on this page represents TI's knowledge and belief as of the date that it is provided. TI bases its knowledge and belief on information provided by third parties, and makes no representation or warranty as to the accuracy of such information. Efforts are underway to better integrate information from third parties. TI has taken and

continues to take reasonable steps to provide representative and accurate information but may not have conducted destructive testing or chemical analysis on incoming materials and chemicals. TI and TI suppliers consider certain information to be proprietary, and thus CAS numbers and other limited information may not be available for release.

In no event shall TI's liability arising out of such information exceed the total purchase price of the TI part(s) at issue in this document sold by TI to Customer on an annual basis.

OTHER QUALIFIED VERSIONS OF ADS1259 :

- Automotive: [ADS1259-Q1](#)

NOTE: Qualified Version Definitions:

- Automotive - Q100 devices qualified for high-reliability automotive applications targeting zero defects

TAPE AND REEL INFORMATION

QUADRANT ASSIGNMENTS FOR PIN 1 ORIENTATION IN TAPE

*All dimensions are nominal

Device	Package Type	Package Drawing	Pins	SPQ	Reel Diameter (mm)	Reel Width W1 (mm)	A0 (mm)	B0 (mm)	K0 (mm)	P1 (mm)	W (mm)	Pin1 Quadrant
ADS1259BIPWR	TSSOP	PW	20	2000	330.0	16.4	6.95	7.1	1.6	8.0	16.0	Q1
ADS1259IPWR	TSSOP	PW	20	2000	330.0	16.4	6.95	7.1	1.6	8.0	16.0	Q1

TAPE AND REEL BOX DIMENSIONS

*All dimensions are nominal

Device	Package Type	Package Drawing	Pins	SPQ	Length (mm)	Width (mm)	Height (mm)
ADS1259BIPWR	TSSOP	PW	20	2000	356.0	356.0	35.0
ADS1259IPWR	TSSOP	PW	20	2000	356.0	356.0	35.0

TUBE

*All dimensions are nominal

Device	Package Name	Package Type	Pins	SPQ	L (mm)	W (mm)	T (μm)	B (mm)
ADS1259BIPW	PW	TSSOP	20	70	530	10.2	3600	3.5
ADS1259IPW	PW	TSSOP	20	70	530	10.2	3600	3.5

PW0020A



PACKAGE OUTLINE

TSSOP - 1.2 mm max height

SMALL OUTLINE PACKAGE



4220206/A 02/2017

NOTES:

- All linear dimensions are in millimeters. Any dimensions in parenthesis are for reference only. Dimensioning and tolerancing per ASME Y14.5M.
- This drawing is subject to change without notice.
- This dimension does not include mold flash, protrusions, or gate burrs. Mold flash, protrusions, or gate burrs shall not exceed 0.15 mm per side.
- This dimension does not include interlead flash. Interlead flash shall not exceed 0.25 mm per side.
- Reference JEDEC registration MO-153.

EXAMPLE BOARD LAYOUT

PW0020A

TSSOP - 1.2 mm max height

SMALL OUTLINE PACKAGE



LAND PATTERN EXAMPLE
EXPOSED METAL SHOWN
SCALE: 10X



SOLDER MASK DETAILS

4220206/A 02/2017

NOTES: (continued)

6. Publication IPC-7351 may have alternate designs.
7. Solder mask tolerances between and around signal pads can vary based on board fabrication site.

EXAMPLE STENCIL DESIGN

PW0020A

TSSOP - 1.2 mm max height

SMALL OUTLINE PACKAGE



SOLDER PASTE EXAMPLE
BASED ON 0.125 mm THICK STENCIL
SCALE: 10X

4220206/A 02/2017

NOTES: (continued)

8. Laser cutting apertures with trapezoidal walls and rounded corners may offer better paste release. IPC-7525 may have alternate design recommendations.
9. Board assembly site may have different recommendations for stencil design.

PW (R-PDSO-G20)

PLASTIC SMALL OUTLINE



- NOTES:
- A. All linear dimensions are in millimeters.
 - B. This drawing is subject to change without notice.
 - C. Publication IPC-7351 is recommended for alternate design.
 - D. Laser cutting apertures with trapezoidal walls and also rounding corners will offer better paste release. Customers should contact their board assembly site for stencil design recommendations. Refer to IPC-7525 for other stencil recommendations.
 - E. Customers should contact their board fabrication site for solder mask tolerances between and around signal pads.

IMPORTANT NOTICE AND DISCLAIMER

TI PROVIDES TECHNICAL AND RELIABILITY DATA (INCLUDING DATA SHEETS), DESIGN RESOURCES (INCLUDING REFERENCE DESIGNS), APPLICATION OR OTHER DESIGN ADVICE, WEB TOOLS, SAFETY INFORMATION, AND OTHER RESOURCES "AS IS" AND WITH ALL FAULTS, AND DISCLAIMS ALL WARRANTIES, EXPRESS AND IMPLIED, INCLUDING WITHOUT LIMITATION ANY IMPLIED WARRANTIES OF MERCHANTABILITY, FITNESS FOR A PARTICULAR PURPOSE OR NON-INFRINGEMENT OF THIRD PARTY INTELLECTUAL PROPERTY RIGHTS.

These resources are intended for skilled developers designing with TI products. You are solely responsible for (1) selecting the appropriate TI products for your application, (2) designing, validating and testing your application, and (3) ensuring your application meets applicable standards, and any other safety, security, regulatory or other requirements.

These resources are subject to change without notice. TI grants you permission to use these resources only for development of an application that uses the TI products described in the resource. Other reproduction and display of these resources is prohibited. No license is granted to any other TI intellectual property right or to any third party intellectual property right. TI disclaims responsibility for, and you will fully indemnify TI and its representatives against, any claims, damages, costs, losses, and liabilities arising out of your use of these resources.

TI's products are provided subject to [TI's Terms of Sale](#) or other applicable terms available either on ti.com or provided in conjunction with such TI products. TI's provision of these resources does not expand or otherwise alter TI's applicable warranties or warranty disclaimers for TI products.

TI objects to and rejects any additional or different terms you may have proposed.

Mailing Address: Texas Instruments, Post Office Box 655303, Dallas, Texas 75265
Copyright © 2022, Texas Instruments Incorporated

单击下面可查看定价，库存，交付和生命周期等信息

[>>TI\(德州仪器\)](#)