

Lithium-ion Linear Charger IC with Shutdown and Current Path Function

■ GENERAL DESCRIPTION

Equipped with a system power supply function, the XC6806 is a linear charger IC for single-cell lithium ion batteries and lithium polymer batteries. The current path function gives system power supply priority over charging the lithium ion battery. The charge current can be adjusted with an external resistance, and an internal limit circuit with an input current of 450mA automatically reduces the charging current based on the load current that flows to the system.

The lithium ion battery temperature is monitored in conformance with JEITA, and by controlling the charge voltage and charge current as appropriate for the temperature, the battery can be charged safely. Internal protective functions include the charge timer, UVLO, thermal control, and reverse current prevention.

Shutdown function completely shuts off power supply from the battery to the system to prevent battery leakage current while the device is not in use, and this enables longer use of low supply current devices that operate using a small battery.

Charge status, connection status with USB can be confirmed with CSO terminal and PGB terminal.

The IC is mounted in the small, high heat dissipation USP-10B or LGA-10B01 package, and a charging circuit can be designed with minimal external components.

■ APPLICATIONS

- Wearable devices
- Bluetooth headsets
- Wireless earphone/Bluetooth earphone
- Hearing Aid
- Health care devices
- IoT sensors

■ FEATURES

Operating Voltage Range	: 4.5 ~ 5.5V
Charge Voltage	: 3.50V ~ 4.45V ±30mV
Charge Current	: 10mA ~ 385mA Can be set by external resistance
Input Current Limit	: 450mA, fixed internally
Battery Sink Current	: 0.1µA (Attached Battery only)
Functions	: Current Path : JEITA Conforming Thermistor Detect : Shutdown
Protection Function	: Charge Timer : UVLO : Thermal Control : Reverse Current Prevention
Operating Ambient Temperature	: -40°C ~ 85°C
Package	: USP-10B, LGA-10B01
Environmentally Friendly	: EU RoHS Compliant, Pb Free

■ TYPICAL APPLICATION CIRCUIT

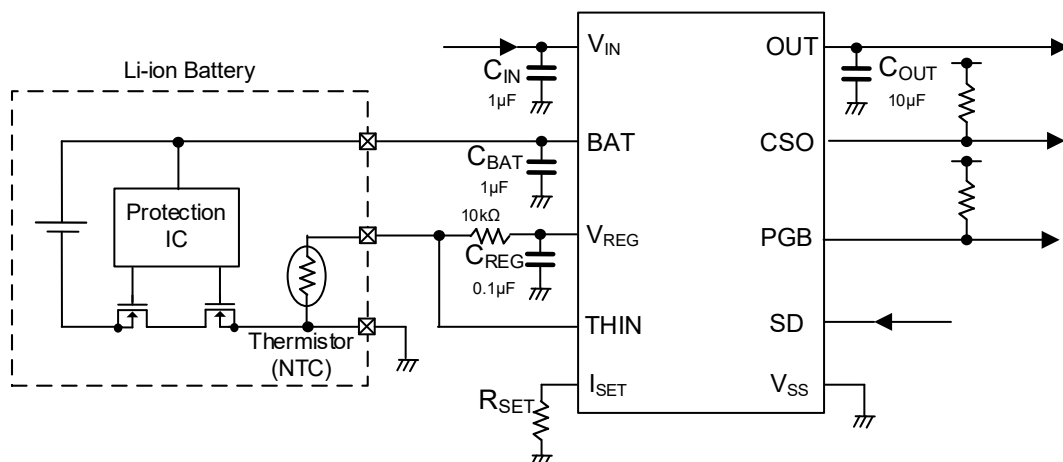

■ BLOCK DIAGRAM

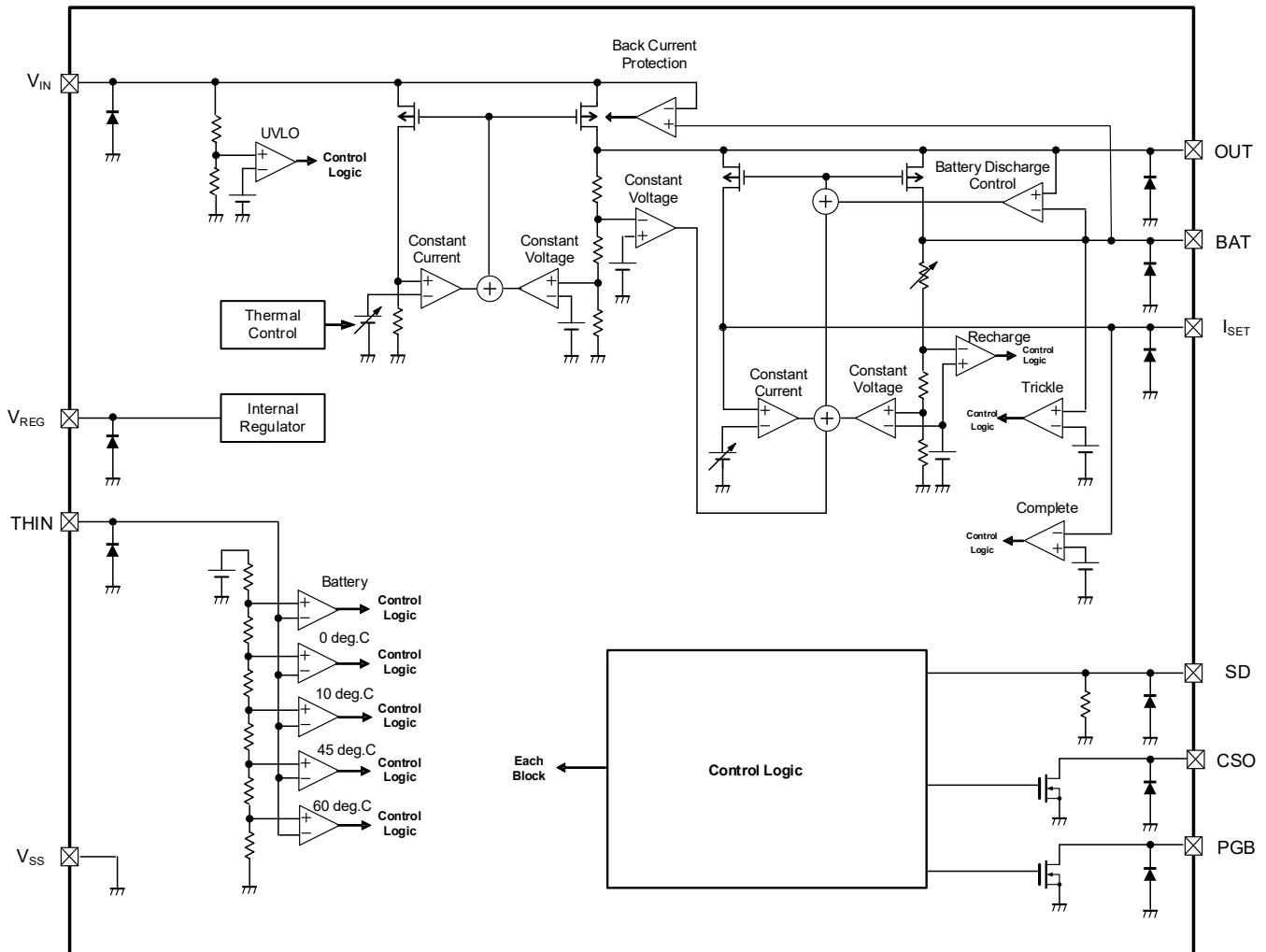

* The diodes above are electrostatic protection diodes and parasitic diodes.

■ PRODUCT CLASSIFICATION

XC6806①②③④⑤⑥-⑦

DESIGNATOR	ITEM	SYMBOL	DESCRIPTION
①	TYPE	A	4 Temperature Monitor (JEITA Compliant)
		B	3 Temperature Monitor (Semi-custom)
		C	2 Temperature Monitor (Semi-custom)
②③④	Charge Voltage	350 ~ 445	3.50V ~ 4.45V
⑤⑥-⑦ ^(*)	Packages (Order Unit)	DR-G	USP-10B (3,000pcs/Reel) ^(**)
		11-G	LGA-10B01 (5,000pcs/Reel)

^(*) The "-G" suffix indicates that the products are Halogen and Antimony free as well as being fully EU RoHS compliant.

^(**) The reels are shipped in a moisture-proof packing. Please consult with your Torex sales contact.

■ PIN CONFIGURATION

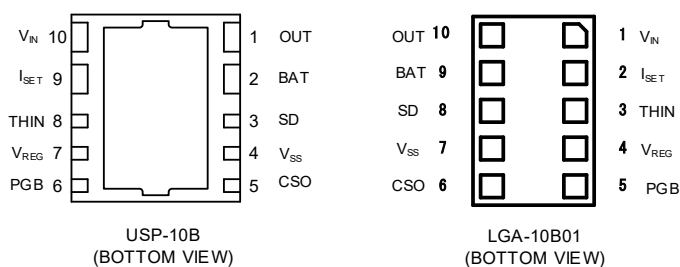

*The dissipation pad for the USP-10B package should be solder-plated in recommended mount pattern and metal masking so as to enhance mounting strength and heat release. When taking out a potential of the heat-sink, connect with V_{SS} pin (#4 pin).

■ PIN ASSIGNMENT

PIN NUMBER		PIN NAME	FUNCTIONS
USP-10B	LGA-10B01		
1	10	OUT	Output Power to The System
2	9	BAT	Battery Connection
3	8	SD	Shutdown Control
4	7	V_{SS}	Ground
5	6	CSO	Charge Status Output
6	5	PGB	Power Good Status Output
7	4	V_{REG}	Internal Regulator Output
8	3	THIN	Temperature Detection
9	2	I_{SET}	Charge Current Setup
10	1	V_{IN}	Power Supply Input

■ FUNCTION

PIN NAME	SIGNAL	STATUS
SD	Rising Edge at UVLO Detect	Shutdown Function (Turn off The Pch Driver between the OUT pin and the BAT pin)
	Other Signal	Keep The Actual Condition
PGB	ON (Low impedance)	Active (UVLO Release)
	OFF (High impedance)	UVLO Detect
CSO	ON (Low impedance)	Trickle Charge, Main Charge
	OFF (High impedance)	Charge Completion, Charger Disable
	1kHz Oscillation	Abnormal Mode

■ ABSOLUTE MAXIMUM RATING

Ta=25°C

PARAMETER		SYMBOL	RATINGS	UNITS
VIN Pin Voltage		V _{IN}	-0.3 ~ 6.5	V
OUT Pin Voltage		V _{OUT}	-0.3 ~ 6.5	V
BAT Pin Voltage		V _{BAT}	-0.3 ~ 6.5	V
V _{REG} Pin Voltage		V _{REG}	-0.3 ~ V _{IN} + 0.3 or 6.5 ^{(*)1}	V
CSO Pin Voltage		V _{CSO}	-0.3 ~ 6.5	V
PGB Pin Voltage		V _{PGB}	-0.3 ~ 6.5	V
I _{SET} Pin Voltage		V _{ISET}	-0.3 ~ OUT + 0.3 or 6.5 ^{(*)2}	V
THIN Pin Voltage		V _{THIN}	-0.3 ~ 6.5	V
SD Pin Voltage		V _{SD}	-0.3 ~ 6.5	V
Terminal Voltage between V _{IN} and OUT Condition: V _{BAT} ≤ 2.3V		V _{DS}	-5.5 ~ 5.5	V
OUT Pin Current		I _{OUT}	1000	mA
BAT Pin Current		I _{BAT}	500	mA
Power Dissipation	USP-10B	P _d	150	mW
	LGA-10B01		1000 (40mm x 40mm Standard Board) ^{(*)3}	
			1200 (40mm x 40mm Standard Board) ^{(*)3}	
Operating Ambient Temperature		T _{opr}	-40 ~ 85	°C
Storage Temperature		T _{stg}	-55 ~ 125	°C

Each rating voltage is based on the V_{ss}.

(*)1 Either of lower one, V_{IN}+0.3V or 6.5V, is applicable.

(*)2 Either of lower one, OUT+0.3V or 6.5V, is applicable.

(*)3 Please refer to PACKAGING INFORMATION for the mounting condition.

ELECTRICAL CHARACTERISTICS

XC6806 Series

Unless otherwise stated, $V_{IN}=5V$, $C_{IN}=C_{BAT}=1\mu F$, $C_{OUT}=10\mu F$, $C_{REG}=0.1\mu F$, $T_a=25^\circ C$

PARAMETER	SYMBOL	CONDITIONS	MIN.	TYP.	MAX.	UNITS	CIRCUIT
Input Voltage	V_{IN}		4.5	5.0	5.5	V	-
Supply Current ^(*)	I_{SS}	V_{IN} to V_{SS}	-	200	-	μA	①
SD Low Level Voltage	V_{SDL}		-	-	0.3	V	①
SD High Level Voltage	V_{SDH}		1.5	-	-	V	①
SD Pull-down Resistance	R_{SD}		40	100	170	k Ω	①
UVLO Threshold Voltage	V_{UVLO}	Rising	4.1	4.2	4.3	V	①
UVLO Hysteresis Voltage ^(*)	V_{UVLOH}		-	100	-	mV	①
Input Current Limit	I_{INL}		405	450	495	mA	①
OUT Regulation Voltage	V_{OUT}	$I_{OUT}=200mA$, $I_{BAT}=0mA$	4.5	4.6	4.7	V	①
OUT Regulation Voltage on Charge Current Reduction	V_{OCCR}	$I_{OUT}=200mA$, $R_{SET}=0.68k\Omega$	3.85	3.95	4.05	V	①
Trickle Charge Threshold Voltage	V_{TRK}	Rising	2.8	2.9	3.0	V	①
Trickle Charge Hysteresis Voltage ^(*)	V_{TRKH}		-	100	-	mV	①
Charge Voltage	V_{CV}	$I_{BAT}=20mA$	V_{CVT} -0.03	$V_{CVT}^{(*)}$	V_{CVT} +0.03	V	①
Charge Voltage on Hot Operation	V_{CVH}	$I_{BAT}=20mA$, Type A Only	V_{CVT} -0.18	V_{CVT} -0.15	V_{CVT} -0.12	V	①
Recharge Threshold Voltage	V_{RC}		-	$V_{CV}-0.1$ or $V_{CVH}-0.1$	-	V	①
Trickle Charge Current (Min.)	I_{TRKL}	$R_{SET}=30k\Omega$	0.6	1.5	2.4	mA	①
Trickle Charge Current (Max.)	I_{TRKM}	$R_{SET}=0.68k\Omega$	36	45	54	mA	①
Charge Current (Min.)	I_{BATL}	$R_{SET}=30k\Omega$	5	10	15	mA	①
Charge Current (Max.)	I_{BATM}	$R_{SET}=0.68k\Omega$	340	385	430	mA	①
Charge Current on Cold Operation (Min.)	I_{BATCL}	$R_{SET}=30k\Omega$, Type A, B Only	3	6	9	mA	①
Charge Current on Cold Operation (Max.)	I_{BATCM}	$R_{SET}=0.68k\Omega$, Type A, B Only	175	200	225	mA	①
Charge Completion Current (Min.)	I_{COL}	$R_{SET}=30k\Omega$	0.6	1.5	2.4	mA	①
Charge Completion Current (Max.)	I_{COM}	$R_{SET}=0.68k\Omega$	36	45	54	mA	①
Battery Discharge Threshold Voltage for OUT Pin	V_{BD}		-	$V_{BAT}-0.1$	-	V	①
CSO, PGB ON Voltage	V_{CP}	$I_{CSO}=I_{PGB}=10mA$	-	-	0.5	V	①
CSO, PGB Leakage Current	I_{LCP}	$V_{CSO}=V_{PGB}=5.5V$	-	-	0.1	μA	①
Output Driver ON Resistance	R_{OUT}		-	300	-	m Ω	①
Charge Driver ON Resistance	R_{CHG}		-	300	-	m Ω	①
BAT Sink Current	I_{BSC}	$V_{BAT}=4.5V$ Charge Completion	-	0.2	1.0	μA	①
BAT Sink Current at UVLO	I_{BAT}	$V_{IN}=V_{SD}=0V$, $I_{OUT}=0A$	-	0.1	0.5	μA	①
BAT Sink Current at Shutdown	I_{BSD}	$V_{IN}=V_{OUT}=V_{SD}=0V$ after Toggle(L→H→L) Signal to SD Pin	-	0.1	0.5	μA	①

^(*) Design value

^(*) Setting Value

ELECTRICAL CHARACTERISTICS

XC6806 Series Unless otherwise stated, $V_{IN}=5V$, $C_{IN}=C_{BAT}=1\mu F$, $C_{OUT}=10\mu F$, $C_{REG}=0.1\mu F$, $T_a=25^\circ C$

PARAMETER	SYMBOL	CONDITIONS	MIN	TYP	MAX	UNIT	CIRCUIT
V_{REG} Output Voltage	V_{REG}		3.267	3.300	3.333	V	①
Battery Connect Detection ^(*)	V_{TD}		-	80	-	% ^(*)	①
Battery Remove Detection(Hysteresis) ^(*)	V_{TDH}	At temperature fall	-	3	-	% ^(*)	①
Thermistor Detection at 0°C	V_{T0}		71.13	73.13	75.13	% ^(*)	①
Thermistor Detection Hysteresis at 0°C ^(*)	V_{T0H}	At temperature rise	-	2	-	% ^(*)	①
Thermistor Detection at 10°C	V_{T10}	Type A, B Only	62.19	64.19	66.19	% ^(*)	①
Thermistor Detection Hysteresis at 10°C ^(*)	V_{T10H}	At temperature rise Type A, B Only	-	2	-	% ^(*)	①
Thermistor Detection at 45°C	V_{T45}	Type A, B Only	30.96	32.96	34.96	% ^(*)	①
Thermistor Detection Hysteresis at 45°C ^(*)	V_{T45H}	At temperature fall Type A, B Only	-	2	-	% ^(*)	①
Thermistor Detection at 60°C	V_{T60}	Type A, C Only	21.16	23.16	25.16	% ^(*)	①
Thermistor Detection Hysteresis at 60°C ^(*)	V_{T60H}	At temperature fall Type A, C Only	-	2	-	% ^(*)	①
Trickle Charge Hold Time ^(*)	t_{TRK}		-	0.5	-	hrs	①
Main Charge Hold Time ^(*)	t_{CHG}		-	5	-	hrs	①
Thermal Control Start Temperature ^(*)	T_{CS}		-	95	-	°C	①

^(*) Design value

^(*) The comparator detect voltage and hysteresis width are indicated as percentages of the IC internal reference voltage V_{REG} (taken to be 100%).

TEST CIRCUITS

Test Circuit①

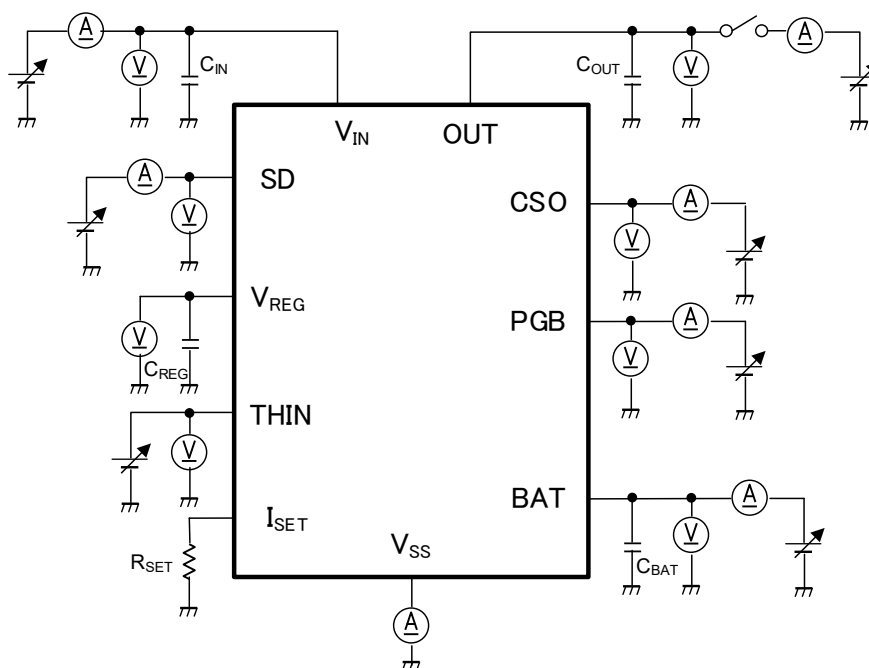

OPERATIONAL EXPLANATION

<Charge Function>

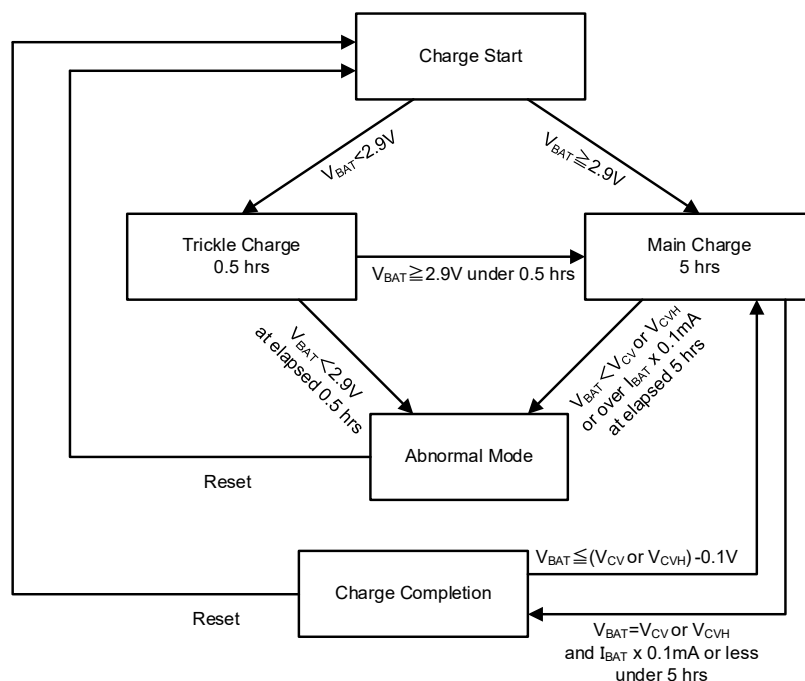

●Charge Start

When UVLO release (V_{UVLO}) takes place due to power on, and when battery connection is detected (V_{TD}) due to insertion of the lithium ion battery, charge starts after 20 ms elapses. If the power is not on or the battery is not inserted, charge will not start. If the system load current is 450mA or higher, the input current limit (I_{INL}) activates and charge of the lithium ion battery does not start. When the load current is less than 450mA, charge starts.

●Trickle Charge: 0.5 hour

If the BAT pin voltage has not reached 2.9V (V_{TRK}), the lithium ion battery is charged at a current that is 1/10 the main charge current. If the BAT pin voltage rises to 2.9V (V_{TRK}) within 0.5 hours (t_{TRK}), the IC transitions to main charge after 4ms. During trickle charge, the CSO pin output is ON. If the BAT pin voltage does not reach 2.9V (V_{TRK}) after 0.5 hours (t_{TRK}), the IC transitions to the abnormal mode and charge stops.

●Main Charge: 5 hours

When the condition for charge from trickle charge to main charge is satisfied, the lithium ion battery is charged at the charge current set with the external resistance (R_{SET}) connected to the I_{SET} pin. During main charging, the CSO pin output is ON. If the BAT pin voltage rises to the charge voltage (V_{CV} or V_{CVH}) within 5 hours (t_{CHG}) and the charge current drops to the charge completion current, which is 1/10 the charge current set with the external resistor (R_{SET}), the IC transitions to the charge completion after 4ms and charge stops. If the charge current is still higher than the charge completion current after 5 hours (t_{CHG}), the IC transitions to the abnormal mode and charge stops.

The main charge current can be set to a value from 10mA (I_{BATL}) to 385mA (I_{BATM}) using an external resistor (R_{SET}). The charge current value (I_{BAT}) set with R_{SET} is approximated by the following equation.

$$R_{SET} \text{ (k}\Omega\text{)} = 421 \times I_{BAT}^{-1.08} \text{ (mA)}$$

●Charge Completion

When the condition for transition from main charge to charge completion is satisfied, charge of the lithium ion battery stops and the CSO pin output turns OFF. Reset takes place when the power is turned off-on or the lithium ion battery is reinserted.

●Recharge Function

When the BAT pin voltage drops from the charge voltage (V_{CV} or V_{CVH}) to 0.1V (V_{RC}) after charge completion, charge automatically resumes after 8ms elapses.

●Abnormal Mode

If trickle charge continues for 0.5 hours (t_{TRK}), or main charge continues for 5 hours (t_{CHG}), an abnormal is detected and charge stops. When an abnormal mode, the CSO pin output oscillates at 1 kHz. Reset takes place when the power is turned off-on or the lithium ion battery is reinserted.

OPERATIONAL EXPLANATION (Continued)

<Current Path Function>

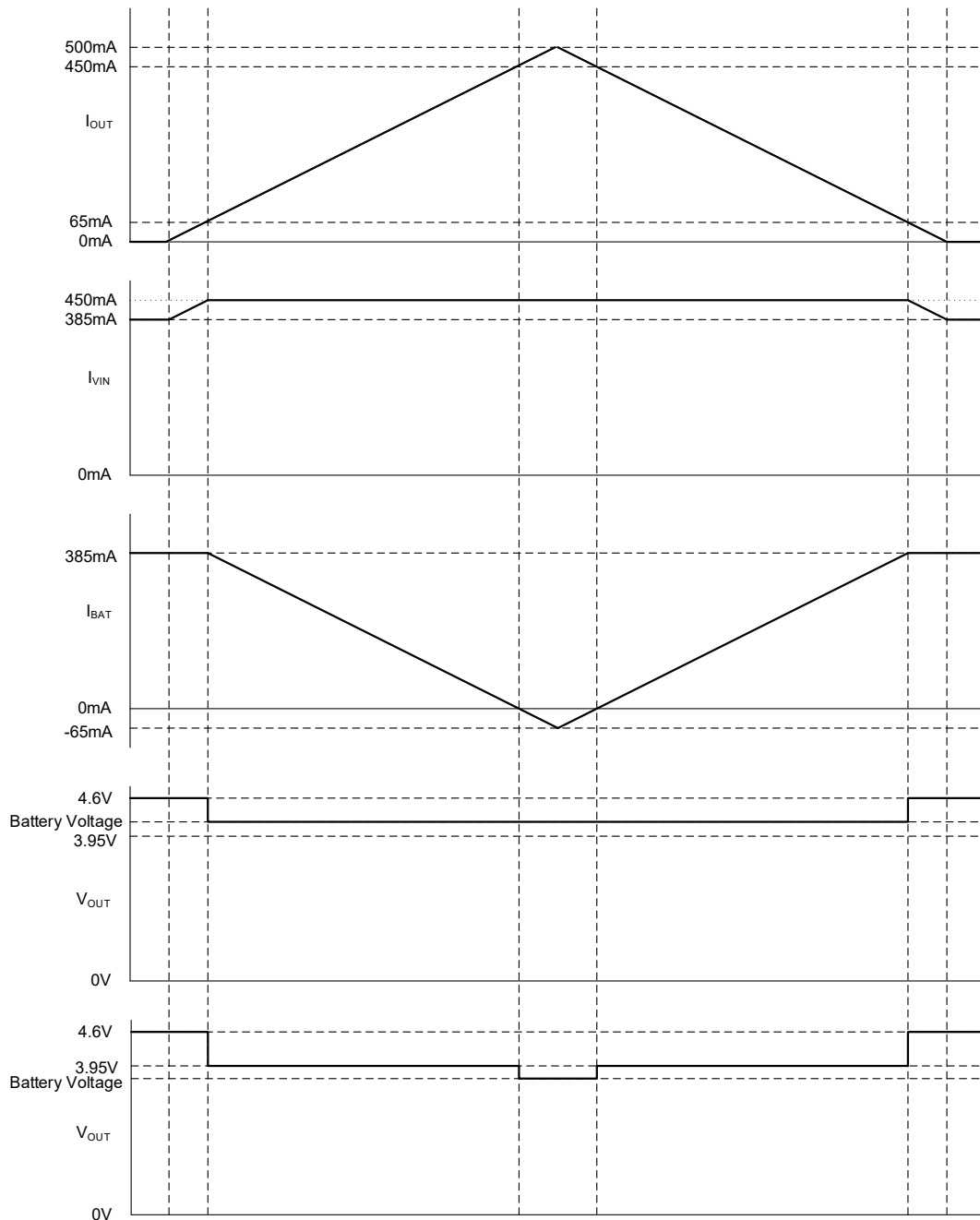

Power is supplied to the system from the OUT pin at the same time as the lithium ion battery is charged. A current limit function is incorporated, and while the input current limit is not exceeded, priority is given to supply of power to the system than charge current to the battery. If the load current to the system exceeds the 450mA input current limit (I_{INL}), current is also supplied from the lithium ion battery by the battery discharge control function. When the OUT pin voltage drops below the BAT pin voltage by 0.1V or more (V_{BD}) during supply from the battery, the Pch driver between the OUT pin and BAT pin turns ON.

When there is little load current from the OUT pin, the OUT pin outputs 4.6V (V_{OUT}). When the load current increases and together with the charge current exceeds the 450mA input limit current (I_{INL}), the charge current is decreased and the current from the power input pin V_{IN} is held at 450mA. At this time the OUT pin becomes the battery voltage if the battery voltage during charging is 3.95V or higher. If the battery voltage is lower than 3.95V, 3.95V (V_{OCCR}) is output. If the load current increases further and reaches 450mA or higher, current is also supplied from the lithium ion battery and the OUT pin voltage becomes the battery voltage.

Note that when the V_{IN} pin voltage is low and the input current is large, the current is limited to a value smaller than the 450mA input current limit (I_{INL}), as determined by the ON resistance of the output driver. In this case, a drop in the OUT pin voltage and charge current will occur, but charging will continue.

■ OPERATIONAL EXPLANATION (Continued)

< Lithium Ion Battery Temperature Monitor Function >

The XC6806 monitors the temperature of the lithium ion battery by means of an NTC thermistor connected to the THIN pin, and controls the charge current and charge voltage based on the temperature to safely charge the battery. NTC temperature detection conforms to the characteristics of the NCP15XH103F03RC of Murata Manufacturing Co., Ltd. (NTCG103JF103FT of TDK Co., LTD.)

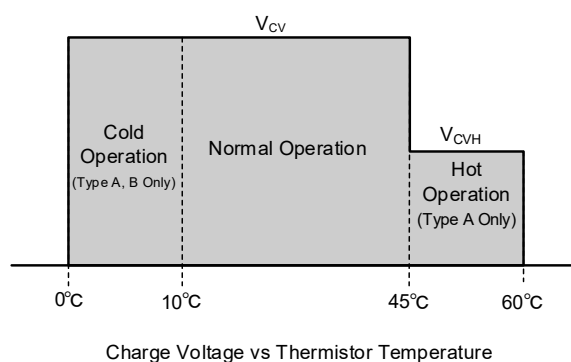
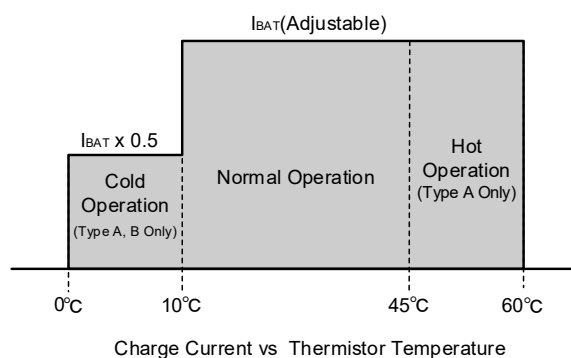

● Type A (4 Temperature Monitor 0°C 10°C 45°C 60°C)

Cold Operation

When $0^{\circ}\text{C} < \text{Thermistor Temperature} \leq 10^{\circ}\text{C}$ (V_{T0} , V_{T10}), the charge current is limited to $I_{\text{BAT}} \times 0.5$.

When Thermistor Temperature $\leq 0^{\circ}\text{C}$ (V_{T0}), charge and the timer count pause. While charge is paused, the CSO pin output is OFF.

Normal Operation

When $10^{\circ}\text{C} < \text{Thermistor Temperature} < 45^{\circ}\text{C}$ (V_{T10} , V_{T45}), the battery is charged at the charge current I_{BAT} and the charge voltage V_{CV} .

Hot Operation

When $45^{\circ}\text{C} \leq \text{Thermistor Temperature} < 60^{\circ}\text{C}$ (V_{T45} , V_{T60}), the charge voltage switches to V_{CVH} and charging continues.

When Thermistor Temperature $\geq 60^{\circ}\text{C}$ (V_{T60}), charge and the timer count pause. While charge is paused, the CSO pin output is OFF.

● Type B (3 Temperature Monitor 0°C 10°C 45°C)

Unlike Type A, Type B does not have 60°C (V_{T60}) monitoring, and at $45^{\circ}\text{C} \leq \text{Thermistor Temperature}$ (V_{T45}), charge and the timer count pause. While charge is paused, the CSO pin output is OFF.

● Type C (2 Temperature Monitor 0°C, 60°C)

Unlike Type A, Type C does not have 10°C (V_{T10}) and 45°C (V_{T45}) monitoring, and when Thermistor Temperature $\leq 0^{\circ}\text{C}$ (V_{T0}) or Thermistor Temperature $\geq 60^{\circ}\text{C}$ (V_{T60}), charge and the timer count pause. While charge is paused, the CSO pin output is OFF.

● V_{REG} Pin

The V_{REG} pin is a reference voltage output pin for internal and external NTC thermistor temperature detection. Connect a 0.1μF capacitor C_{REG} and 10 kΩ resistor. (■Refer to the typical application circuit.)

■ OPERATIONAL EXPLANATION (Continued)

<Shut Down Function>

When the V_{IN} pin falls below 4.1V (V_{UVLOH}) or below the lithium ion battery voltage and the UVLO function activates, the OUT pin and BAT pin conduct via the Pch driver. When High level voltage (V_{SDH}) is input into the SD pin in this state, the rising edge turns OFF the Pch driver between the OUT pin and BAT pin, breaking conduction between the battery and the system. When the power input pin rises above 4.2V (V_{UVLO}) and above the lithium ion battery voltage, and the UVLO function is released, the shutdown function is released. The SD pin includes an internal pull-down resistance (R_{SD}).

<Protection Function>

● UVLO Function

When the V_{IN} pin falls below 4.1V (V_{UVLOH}), or below the lithium ion battery voltage, the OUT pin and BAT pin conduct via the Pch driver, conduction between the V_{IN} pin and OUT pin is broken by the Pch driver, and the IC stops operating. When the V_{IN} pin rises above 4.2V (V_{UVLO}), and above the lithium ion battery voltage, the IC starts.

● Thermal Control Function

A thermal control function is incorporated to prevent destruction and thermal runaway due to heat generation in the IC. When the chip temperature reaches 95°C (T_{CS}), the input current limit is reduced. An abnormal mode does not occur when the thermal control function activates, and the CSO output does not change.

● Back Current Protection Function

To prevent reverse current from the Lithium ion battery to the charger, this function monitors the potential difference between the BAT pin voltage V_{BAT} and the V_{IN} pin voltage. When V_{IN} drops to $V_{BAT} + 0.07V$, the Pch driver between the V_{IN} pin and OUT pin turns OFF, and in addition the backgate connection of the Pch driver is switched from the V_{IN} pin to the BAT pin. When V_{IN} rises above $V_{BAT} + 0.1V$, this function is released, the Pch driver turns ON, and the backgate connects to the V_{IN} pin.

● Timer Reset

In the conditions below, all timers are reset.

- When UVLO is released (V_{UVLO}) at power ON, and at battery connect detection (V_{TD}) when the lithium ion battery is inserted.
- When charge resumes after a load current higher than the 450mA input current limit (I_{INL}) flows to the system and causes charge to stop, and current is then supplied to the system from the battery and the load lightens to less than the 450mA input current limit (I_{INL}).

■ OPERATIONAL EXPLANATION (Continued)

● Low Voltage Operation for the OUT Pin

The IC stops in operation when the OUT pin falls to 2V or less as the OUT pin is shorted to the ground. In this case, the IC restarts when UVLO is active and release.

The input current for the V_{IN} pin is saved 25mA when the IC starts after the OUT pin is 0V by the shutdown function or the external Lithium ion Battery Protection Function. It supplies up to the 450mA input current limit (I_{INL}) when the OUT pin rises over 2V.

CAUTION 1

Additionally, some Li-ion/polymer battery protection circuits conflict with the OUT pin low voltage limiting function. Please check the following specifications of the battery protection circuit.

- Please use the type that completely cuts off after overcurrent detection until the voltage is re-supplied from the charger.
- Please refer to the following when using the type that automatically recovers from over current detection when the load current detection when the load current decreases after detection of over current.

Some battery protection circuits are held in a state where the battery and the protection circuit output are connected with a certain resistance "R" value when over current is detected.

In this case, even if the load current decreases, the current and the "R" are balanced, the BAT pin may be held at 0.5V to 2.0V, and charging is not restarted by the OUT pin low voltage limiting function when a voltage is provided to the V_{IN} pin of this IC.

After detection of over discharge, there is a type of protection IC that automatically recovers from over discharge protection when the battery voltage re-rises without applying voltage for recharging, then switches to overcurrent protection function. In case of this type, please check above.

CAUTION 2

When the XC6806 start up, the BAT pin must 0.5V or less or 2.0V or more.

If it is between 0.5V and 2.0V, the OUT pin low voltage limiting function operates and a battery will not be charged.

When restart from 0.5V or less, the OUT pin low voltage limiting function temporarily stops until the OUT pin exceed 2.0V.

The supply current from V_{IN} is limited to 25mA until it reaches 2.0V at the time of restart to avoid the case where the load circuit is short and other problems.

With this 25mA limit and the OUT pin low voltage limiting function,

- C_{OUT} should be nominally 47 μF or less. If larger C_{OUT} is used, the OUT pin low voltage limiting function may operate at restart.
- When the load current is large, there is a case where it does not start up due to the 25mA limit. Therefore, please delay start of the load circuit to wait for the rise of the OUT pin voltage of XC6806. For example, we recommend measures such as a CR delay to the CE(EN) terminal of LDO and/or DCDC of a load.

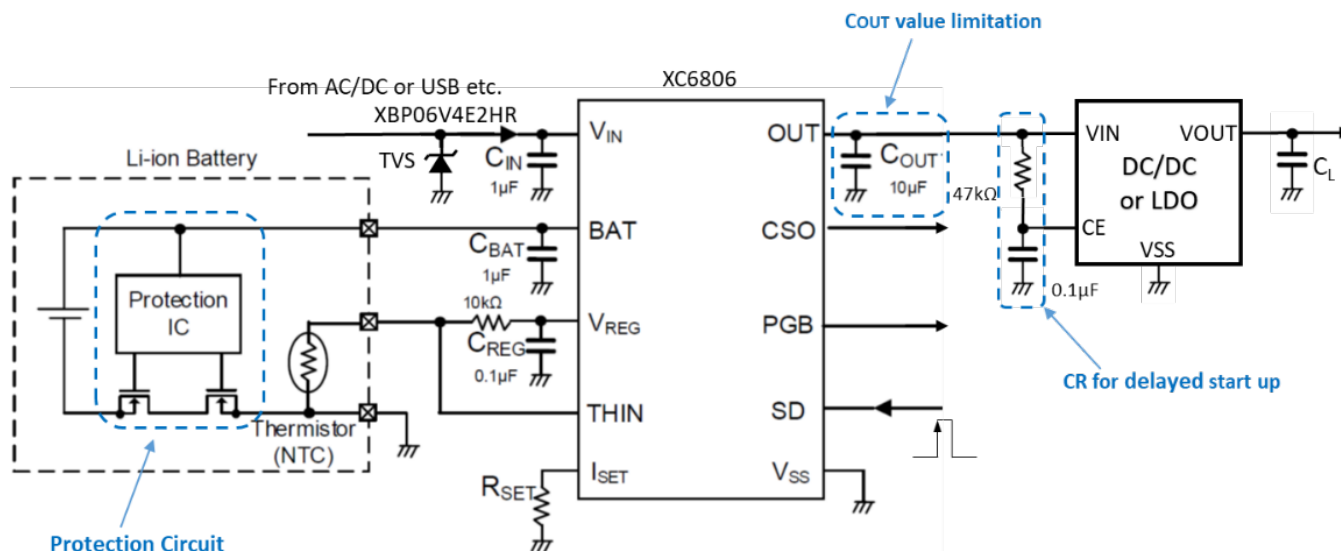

OPERATIONAL EXPLANATION (Continued)

<PGB Pin>

When the power is turned on and the UVLO function is released, the Nch open drain output of the PGB pin turns ON. When the power input pin falls below 4.1V (V_{UVLOH}) or below the lithium ion battery voltage and the UVLO function activates, the output turns OFF.

<Charge Status Output (CSO) Pin>

The CSO pin is an Nch open drain output that changes based on the states of the charging function.

CSO Pin Output Patterns

STATUS	CSO
Trickle Charge	ON
Main Charge	ON
Charge Completion	OFF (Hi-Z)
Abnormal Mode	1kHz Oscillation
Charger Disable	OFF (Hi-Z) ^(*)

^(*) Charge function stop

In the following states, the charging function stops and the CSO pin output turns OFF.

- The shutdown function operates
- The UVLO function operates
- The reverse current protection function operates
- The load current from the OUT pin is larger than the input current limit and current is supplied to the system from the battery
- When the lithium ion battery temperature monitor function is used and the thermistor temperature falls below 0°C (V_{T0}) or rises above 60°C (V_{T60}) (Types A and C)

On Type B, when the thermistor temperature falls below 0°C (V_{T0}) or rises above 45°C (V_{T45})

OPERATIONAL EXPLANATION (Continued)

<Charge Timing Chart>

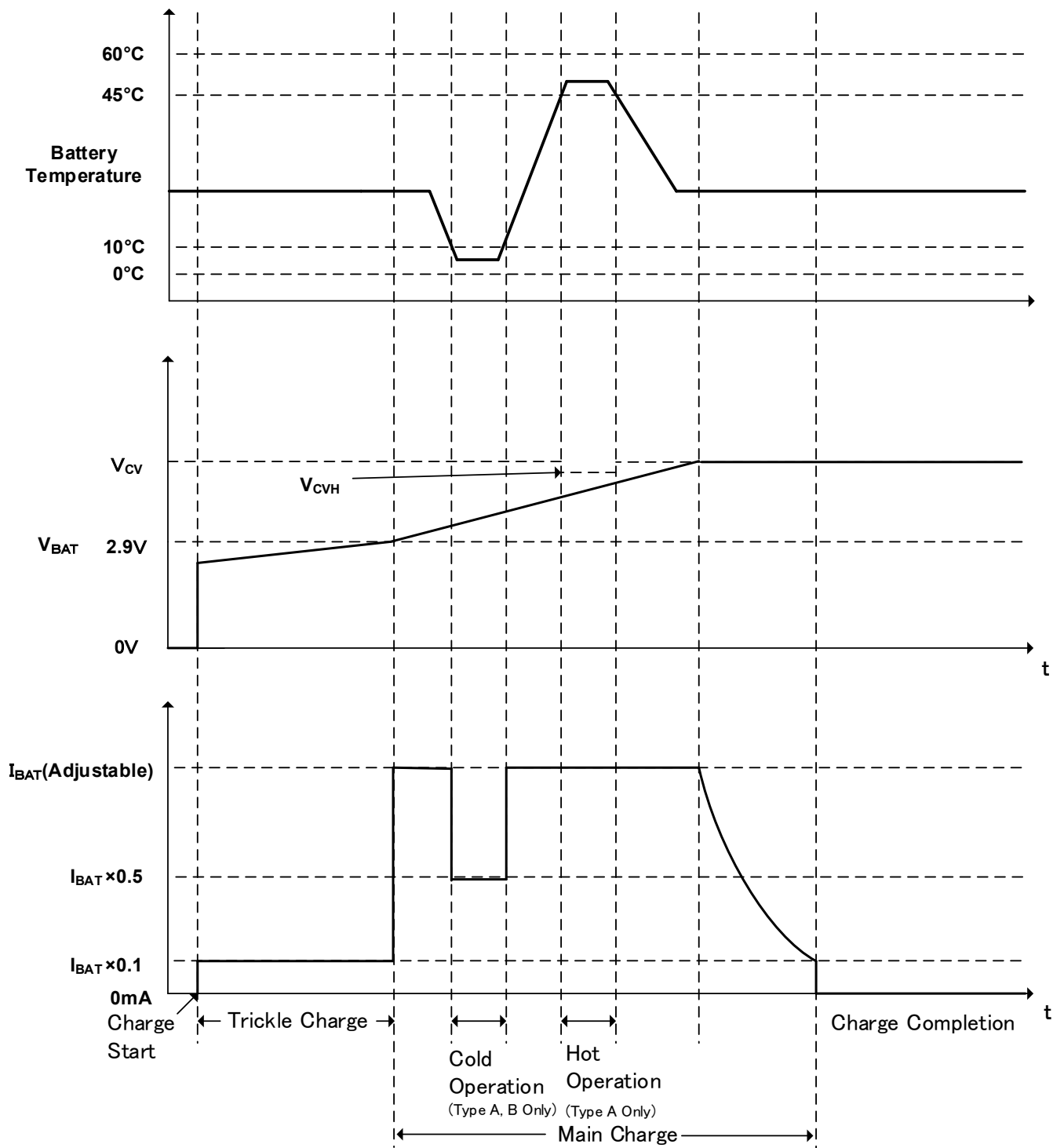

NOTE ON USE

1. Even temporary or transient voltage drops and rises may cause deterioration or destruction if the absolute maximum ratings are exceeded.
2. If the wiring has a high impedance, the output current may cause unstable operation. In particular, strengthen the wiring of the V_{IN} , BAT, and OUT pins.
3. Place the input capacitor (C_{IN}), output capacitors (C_{OUT} , C_{BAT} , C_{REG}), and charge current setting resistor (R_{SET}) as close as possible to the IC to keep the wiring short.
4. An overcurrent protection function is not provided for the current from the BAT pin to the OUT pin. Exercise sufficient caution to ensure that the current does not exceed 500mA.
5. This IC is not integrated the over current protection function from the BAT pin to the OUT pin and the over discharge protection function so should build separately the protection functions for the Lithium Ion Battery.
6. This IC uses an external thermistor for high-accuracy detection and control of temperature. Test the position of the external thermistor sufficiently to verify that temperature can be accurately detected.
7. Risk of destruction if the battery polarity is reversed. Never use with the polarity reversed, as safety cannot be guaranteed in the event that the IC explodes.
8. Short-circuiting to an adjacent pin may cause malfunctioning and damage. Exercise caution during mounting and use.
9. A large ripple voltage on the V_{IN} pin may cause the IC to malfunction. Test sufficiently before use.
10. The set charge current must always be within the range 10mA to 385mA.
11. Do not connect anything other than a resistance to the I_{SET} pin.
12. Do not use the reference voltage output from the V_{REG} pin for any purpose other than NTC thermistor temperature detection.
13. The charge is stopped lower than the setting voltage by the back current protection if the charge voltage is set high and the input voltage is low.
14. Torex places an importance on improving our products and their reliability.
We request that users incorporate fail-safe designs and post-aging protection treatment when using Torex products in their systems.

TYPICAL PERFORMANCE CHARACTERISTICS

(1) Charge Current vs. External Resistor (Normal Operation)

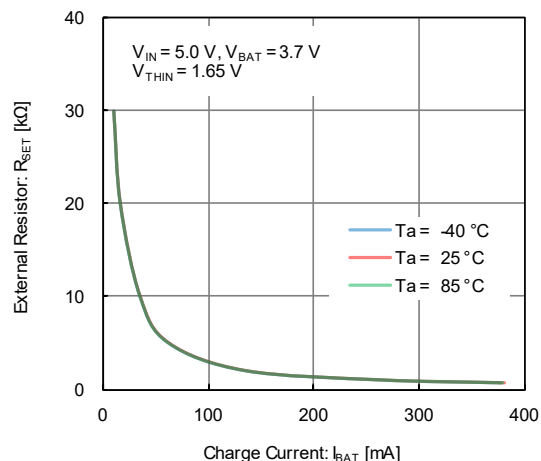

(2) Charge Current vs. Ambient Temperature (Normal Operation)

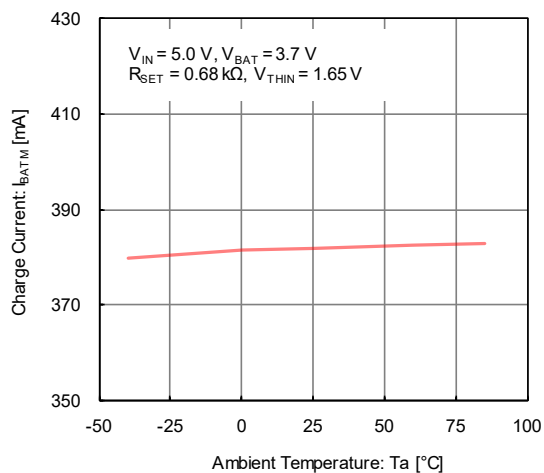

(3) Charge Current vs. Ambient Temperature (Normal Operation)

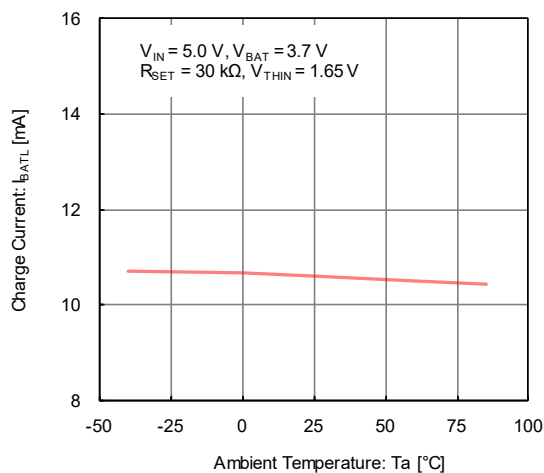

(4) Charge Current vs. Ambient Temperature (Cold Operation)

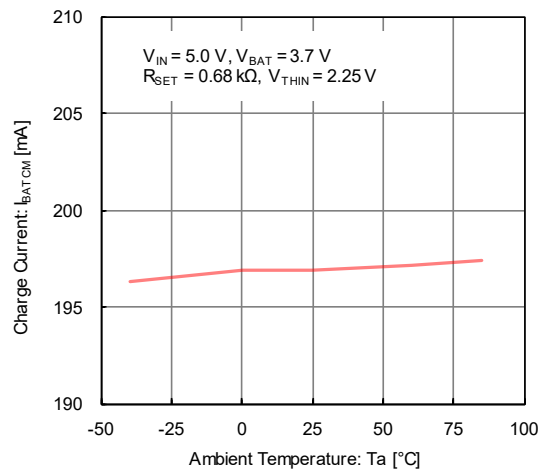

(5) Charge Current vs. Ambient Temperature (Cold Operation)

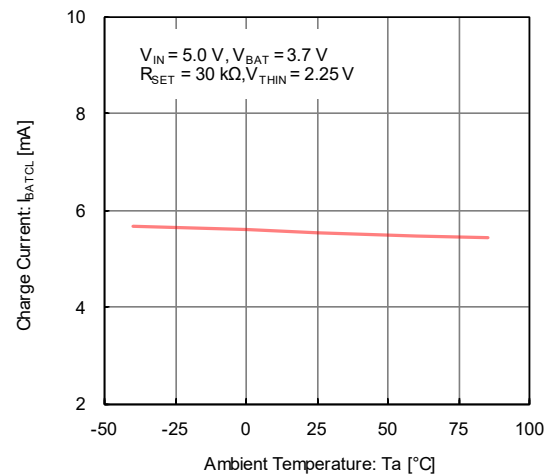

TYPICAL PERFORMANCE CHARACTERISTICS (Continued)

(6) Trickle Charge Current vs. Ambient Temperature

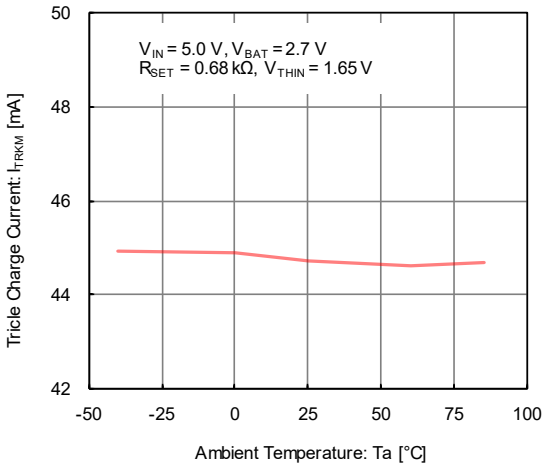

(7) Trickle Charge Current vs. Ambient Temperature

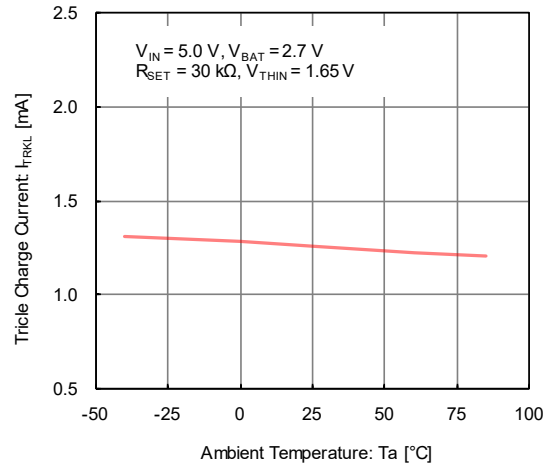

(8) Charge Completion Current vs. Ambient Temperature

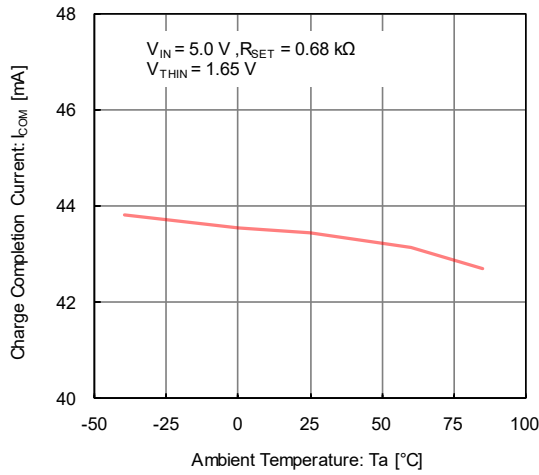

(9) Charge Completion Current vs. Ambient Temperature

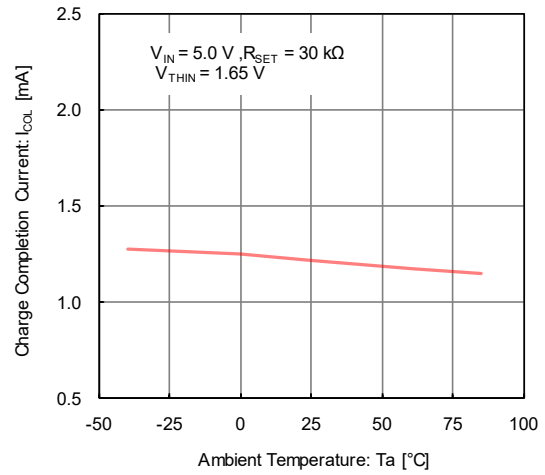

(10) Charge Voltage vs. Charge Current (Normal Operation)

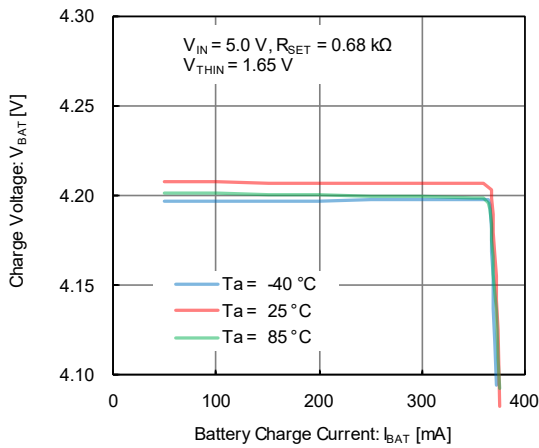

(11) Charge Voltage vs. Charge Current (Hot Operation)

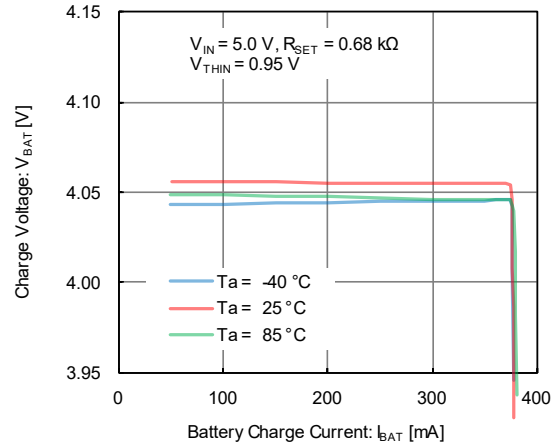

TYPICAL PERFORMANCE CHARACTERISTICS (Continued)

(12) Charge Voltage vs. Charge Current (Normal Operation)

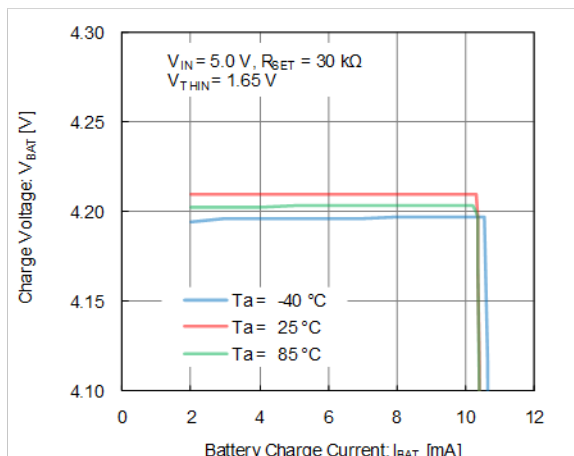

(13) Charge Voltage vs. Charge Current (Hot Operation)

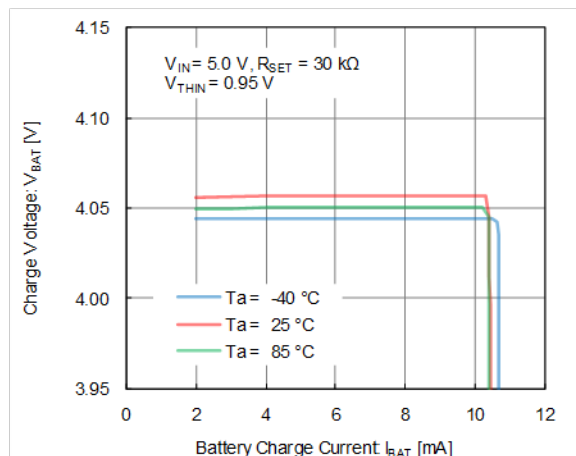

(14) Battery Charge Current vs. BAT Pin Voltage (Normal Operation)

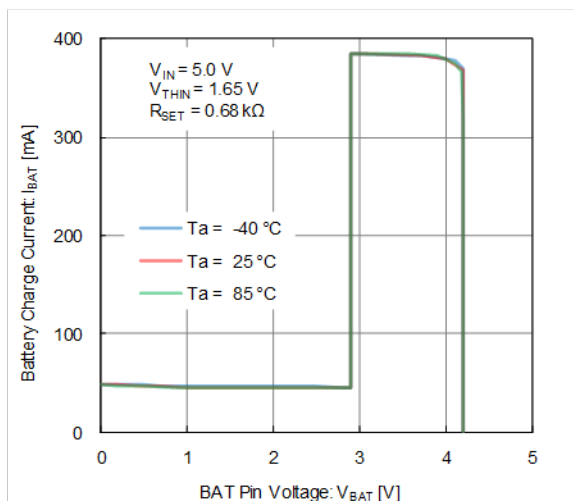

(15) Battery Charge Current vs. BAT Pin Voltage (Cold Operation)

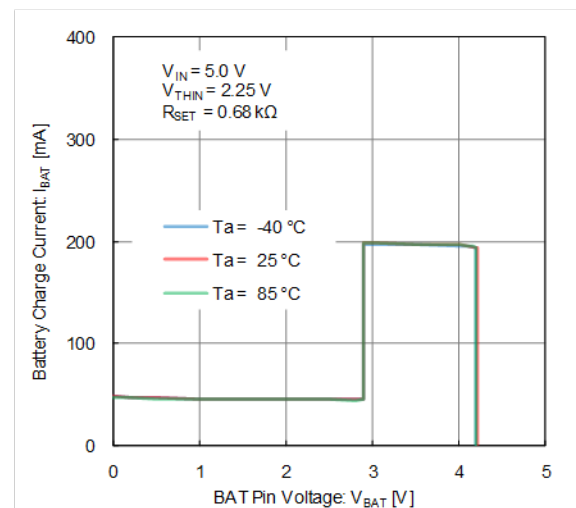

(16) Battery Charge Current vs. BAT Pin Voltage (Normal Operation)

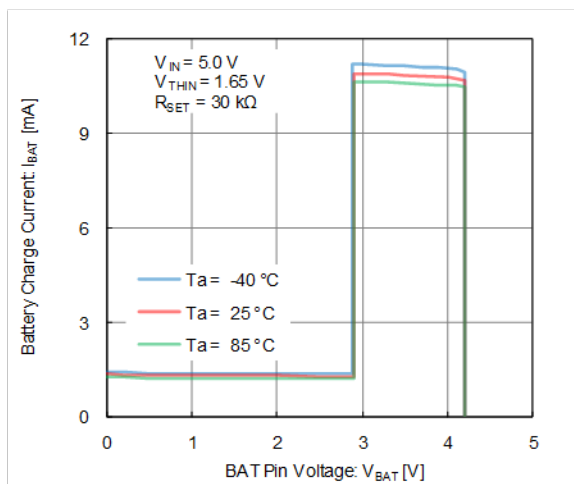

(17) Battery Charge Current vs. BAT Pin Voltage (Cold Operation)

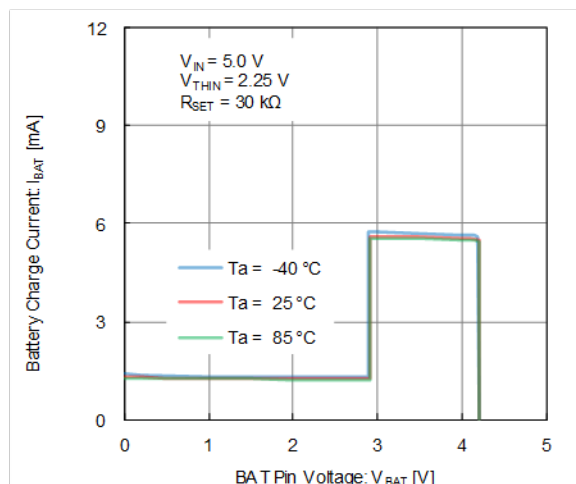

■ PACKAGING INFORMATION

For the latest package information go to, www.torexsemi.com/technical-support/packages

PACKAGE	OUTLIN / LAND PATTERN	THERMAL CHARACTERISTICS	
LGA-10B01	LGA-10B01 PKG	Standard Board	LGA-10B01 Power Dissipation
USP-10B	USP-10B PKG	Standard Board	USP-10B Power Dissipation

■ MARKING RULE

① Represents products series

MARK	PRODUCT SERIES
3	XC6806*****-G

USP-10B

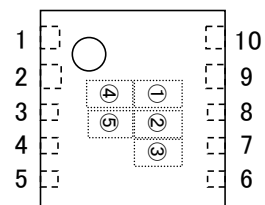

②③ represents internal sequential number

01... 09, 10... 99, A0... A9, B0... B9... Z9... repeated.
(G, I, J, O, Q, W excluded)

LGA-10B01

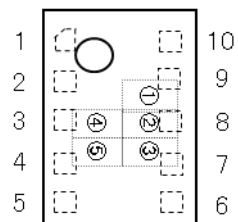

④⑤ represents production lot number

01~09, 0A~0Z, 11...9Z, A1~A9, AA...Z9, ZA~ZZ in order.

(G, I, J, O, Q, W excluded)

* No character inversion used

1. The product and product specifications contained herein are subject to change without notice to improve performance characteristics. Consult us, or our representatives before use, to confirm that the information in this datasheet is up to date.
2. The information in this datasheet is intended to illustrate the operation and characteristics of our products. We neither make warranties or representations with respect to the accuracy or completeness of the information contained in this datasheet nor grant any license to any intellectual property rights of ours or any third party concerning with the information in this datasheet.
3. Applicable export control laws and regulations should be complied and the procedures required by such laws and regulations should also be followed, when the product or any information contained in this datasheet is exported.
4. The product is neither intended nor warranted for use in equipment of systems which require extremely high levels of quality and/or reliability and/or a malfunction or failure which may cause loss of human life, bodily injury, serious property damage including but not limited to devices or equipment used in 1) nuclear facilities, 2) aerospace industry, 3) medical facilities, 4) automobile industry and other transportation industry and 5) safety devices and safety equipment to control combustions and explosions. Do not use the product for the above use unless agreed by us in writing in advance.
5. Although we make continuous efforts to improve the quality and reliability of our products; nevertheless Semiconductors are likely to fail with a certain probability. So in order to prevent personal injury and/or property damage resulting from such failure, customers are required to incorporate adequate safety measures in their designs, such as system fail safes, redundancy and fire prevention features.
6. Our products are not designed to be Radiation-resistant.
7. Please use the product listed in this datasheet within the specified ranges.
8. We assume no responsibility for damage or loss due to abnormal use.
9. All rights reserved. No part of this datasheet may be copied or reproduced unless agreed by Torex Semiconductor Ltd in writing in advance.

TOREX SEMICONDUCTOR LTD.

单击下面可查看定价，库存，交付和生命周期等信息

[>>Torex Semiconductor\(特瑞仕\)](#)