

85mΩ High Function Power Switch

■ GENERAL DESCRIPTION

The XC8107 series is a P-channel MOSFET power switch IC with a low ON resistance. A current limit, reverse current prevention (prevents reverse current from V_{OUT} to V_{IN}), soft start, thermal shutdown, and an under voltage lockout (UVLO) are incorporated as protective functions. A flag function monitors the power switch status. The flag output has N-channel open drain configuration, and it outputs Low level signal when over-current or overheating is detected, or when the reverse current prevention is operated. The voltage level which is fed to CE pin determines the status of XC8107. The logic level of CE pin is selectable between either one of active high or active low.

■ APPLICATIONS

- Set Top Boxes
- Digital TVs
- PCs
- USB Ports/USB Hubs
- HDMI

■ FEATURES

Input Voltage	: 2.5V ~ 5.5V
Maximum Output Current	: 2A
ON Resistance	: 85mΩ@ $V_{IN}=5.0V$ (TYP.) *USP-6C 100mΩ@ $V_{IN}=5.0V$ (TYP.) *SOT-25 (XC8107A,B) 95mΩ@ $V_{IN}=5.0V$ (TYP.) *SOT-25 (XC8107X,Y)
Supply Current	: 40 μA @ $V_{IN}=5.0V$
Stand-by Current	: 0.1 μA (MAX.)
Flag Delay Time	: 7.5ms (TYP.) * At over-current detection : 4ms(TYP.) * At reverse voltage detection
Protection Circuit	: Reverse Current Prevention Thermal Shutdown Under Voltage Lockout(UVLO) Soft-start
Functions	: Flag Output CE Pin Input Logic Selectable
Current Limit Response Time	: 2 μs (TYP.) *Reference value
Operating Ambient Temperature	: -40°C ~ +105°C
Packages	: USP-6C, SOT-25(Au wire or Cu wire)
Environmentally Friendly	: EU RoHS Compliant, Pb Free

■ TYPICAL APPLICATION CIRCUIT

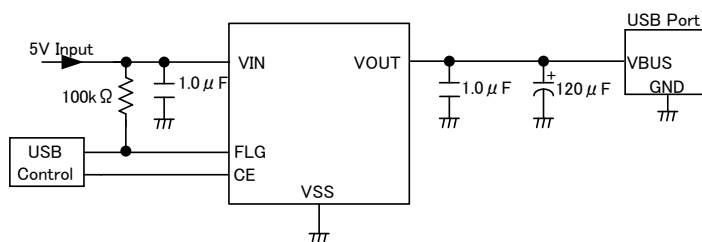

■ TYPICAL PERFORMANCE CHARACTERISTICS

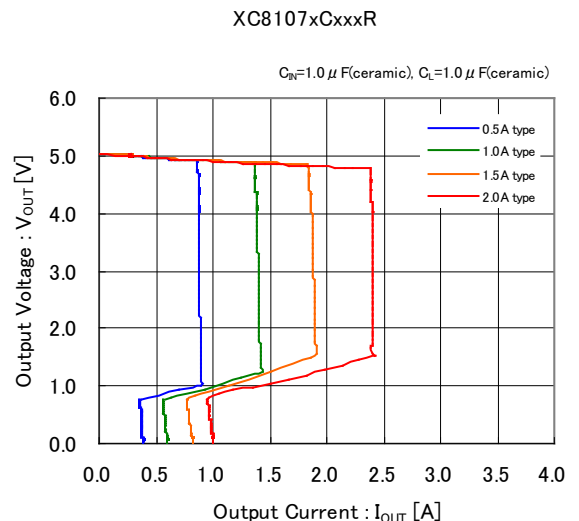

■ BLOCK DIAGRAM

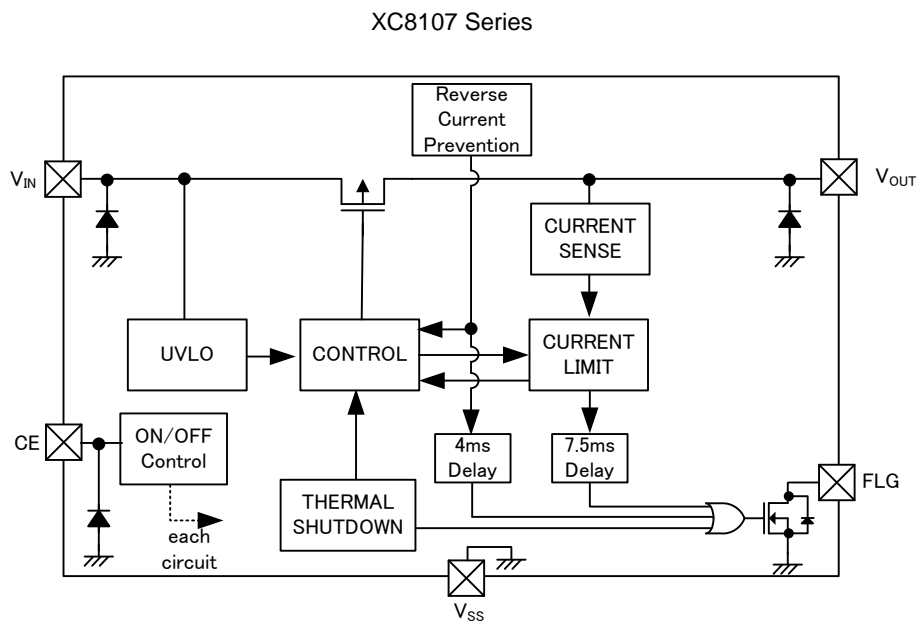

* Diodes inside the circuit are an ESD protection diode and a parasitic diode.

■ PRODUCT CLASSIFICATION

● Ordering Information

XC8107①②③④⑤⑥-⑦

DESIGNATOR	ITEM	SYMBOL		DESCRIPTION
		Au wire	Cu wire	
①	CE Logic	A	X	Refer to Selection Guide
		B	Y	
②	Protection Circuits Type	C		
		D		
③④	Maximum Output Current	05		0.5A
		10		1.0A
		15		1.5A
		20		2.0A
⑤⑥-⑦ (*1)	Packages	ER-G		USP-6C (3,000pcs/Reel) (*2)
		MR-G		SOT-25 (3,000pcs/Reel)

(*1) The "-G" suffix denotes Halogen and Antimony free as well as being fully EU RoHS compliant.

(*2) USP - 6C package is available for the A/B Type.

● Selection Guide

TYPE	CE LOGIC SELECTABLE	SOFT-START	CURRENT LIMITER
AC, XC	Active High	Yes	Yes
AD, XD	Active High	Yes	Yes
BC, YC	Active Low	Yes	Yes
BD, YD	Active Low	Yes	Yes

TYPE	UVLO	FLG OUTPUT	REVERSE CURRENT PREVENTION
AC, XC	Yes	Yes	Yes
AD, XD	Yes	Yes	Yes
BC, YC	Yes	Yes	Yes
BD, YD	Yes	Yes	Yes

TYPE	THERMAL SHUT DOWN	LATCH PROTECTION
AC, XC	Yes	No
AD, XD	Yes	Yes
BC, YC	Yes	No
BD, YD	Yes	Yes

PIN CONFIGURATION

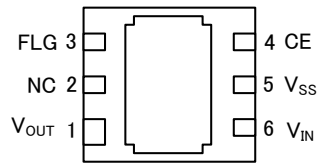

USP-6C
(BOTTOM VIEW)

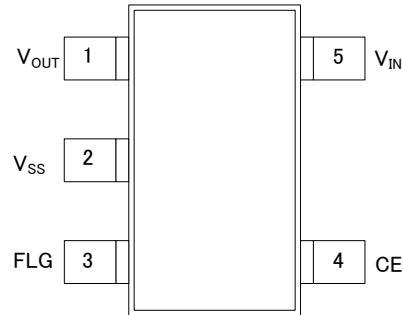

SOT-25
(TOP VIEW)

* The dissipation pad for the USP-6C packages should be solder-plated for mounting strength and heat dissipation. Please refer to the reference mount pattern and metal masking. The dissipation pad should be connected to the V_{SS} (No. 5) pin.

PIN ASSIGNMENT

PIN NAME		PIN NAME	FUNCTIONS
USP-6C	SOT-25		
1	1	V _{OUT}	Output
2	-	NC	No connection
3	3	FLG	Fault Report
4	4	CE	ON/OFF Control
5	2	V _{SS}	Ground
6	5	V _{IN}	Power Input

FUNCTION

PIN NAME	TYPE	Signal	STATUS
CE	A, X	H	Active
		L	Stand-by
		OPEN	Undefined State ^(*)
	B, Y	H	Stand-by
		L	Active
		OPEN	Undefined State ^(*)

* Avoid leaving the CE pin open; set to any fixed voltage.

■ ABSOLUTE MAXIMUM RATINGS

PARAMETER		SYMBOL	RATINGS	UNITS
Input Voltage		V_{IN}	-0.3 ~ +6.0	V
Output Voltage		V_{OUT}	-0.3 ~ +6.0	V
CE Input Voltage		V_{CE}	-0.3 ~ +6.0	V
FLG Pin Voltage		V_{FLG}	-0.3 ~ +6.0	V
FLG Pin Current		I_{FLG}	15	mA
Power Dissipation ($T_a=25^{\circ}C$)	USP-6C	Pd	120	mW
			1000 (40mm x 40mm Standard board) ^(*)	
			1250 (JESD51-7 board) ^(*)	
	SOT-25		250	
			600 (40mm x 40mm Standard board) ^(*)	
Operating Ambient Temperature		T_{opr}	-40 ~ +105	$^{\circ}C$
Storage Temperature		T_{stg}	-55 ~ +125	$^{\circ}C$

* All voltages are described based on the V_{SS} .

^(*) The power dissipation figure shown is PCB mounted and is for reference only.

Please see the power dissipation page for the mounting condition.

ELECTRICAL CHARACTERISTICS

Ta=25°C

PARAMETER	SYMBOL	CONDITIONS	MIN.	TYP.	MAX.	UNITS	CIRCUIT	
Input Voltage	V _{IN}	-	2.5	-	5.5	V	①	
On Resistance	R _{ON}	USP-6C	V _{IN} =3.3V ^(*)	-	100	110	mΩ	①
			V _{IN} =5.0V ^(*)	-	85	104	mΩ	
		SOT-25 (XC8107A,B)	V _{IN} =3.3V ^(*)	-	115	135	mΩ	
			V _{IN} =5.0V ^(*)	-	100	120	mΩ	
		SOT-25 (XC8107X,Y)	V _{IN} =3.3V ^(*)	-	110	130	mΩ	
			V _{IN} =5.0V ^(*)	-	95	115	mΩ	
Supply Current	I _{SS}	V _{OUT} =OPEN	-	40	75	μA	②	
Stand-by Current	I _{STBY}	V _{IN} =5.5V, V _{OUT} =OPEN V _{CE} =V _{SS} (XC8107A,X series) V _{CE} =V _{IN} (XC8107B,Y series)	-	0.01	1.0	μA	②	
Switch Leakage Current	I _{LEAK}	V _{IN} =5.5V, V _{OUT} =0V V _{CE} =V _{SS} (XC8107A,X series) V _{CE} =V _{IN} (XC8107B,Y series)	-	0.01	1.0	μA	②	
Current Limit	I _{LIMIT}	V _{OUT} =V _{IN} -0.3V, XC8107xx05 series	0.81	0.90	0.99	A	①	
		V _{OUT} =V _{IN} -0.3V, XC8107xx10 series	1.26	1.40	1.54	A		
		V _{OUT} =V _{IN} -0.3V, XC8107xx15 series	1.71	1.90	2.09	A		
		V _{OUT} =V _{IN} -0.3V, XC8107xx20 series	2.16	2.40	2.64	A		
Short-Circuit Current	I _{SHORT}	V _{OUT} =0V, XC8107xx05 series	-	0.45	-	A	①	
		V _{OUT} =0V, XC8107xx10 series	-	0.70	-	A		
		V _{OUT} =0V, XC8107xx15 series	-	0.95	-	A		
		V _{OUT} =0V, XC8107xx20 series	-	1.20	-	A		
Current Limit Circuit Response Time ^(*)	t _{CLR}	V _{IN} =5.0V, V _{OUT} : OPEN→0V Measure from V _{OUT} =0V to when current falls below a certain I _{LIMIT} value	-	2.0	-	μs	①	
CE "H" Level Voltage	V _{CEH}	V _{IN} =5.5V, XC8107A,X series	1.5	-	5.5	V	①	
		V _{IN} =5.5V, XC8107B,Y series	-	-	0.8			
CE "L" Level Voltage	V _{CEL}	V _{IN} =5.5V, XC8107A,X series	-	-	0.8	V	①	
		V _{IN} =5.5V, XC8107B,Y series	1.5	-	5.5			
CE "H" Level Current	I _{CEH}	V _{IN} =5.5V, V _{CE} =5.5V	-0.1	-	0.1	μA	①	
CE "L" Level Current	I _{CEL}	V _{IN} =5.5V, V _{CE} =0V	-0.1	-	0.1	μA	①	
UVLO Detected Voltage	V _{UVLOD}	V _{IN} : 2.2V→1.7V	1.8	1.9	2.0	V	①	
UVLO Released Voltage	V _{UVLOR}	V _{IN} : 1.7V→2.2V	1.9	2.0	2.1	V	①	
UVLO Hysteresis	V _{UHYS}	-	-	0.1	-	V	①	

NOTE:

Unless otherwise stated, V_{IN}=5.0V, I_{OUT}=1mA, V_{CE}=V_{IN} (XC8107A, X series) or V_{CE}=V_{SS} (XC8107B, Y series)

^(*) I_{OUT}=0.25A (XC8107xx05 series), I_{OUT}=0.5A (XC8107xx10 series), I_{OUT}=0.75A (XC8107xx15series), I_{OUT}=1.0A (XC8107xx20 series)

⁽²⁾ Design reference value. This parameter is provided only for reference.

■ ELECTRICAL CHARACTERISTICS (Continued)

Ta=25°C

PARAMETER	SYMBOL	CONDITIONS	MIN.	TYP.	MAX.	UNITS	CIRCUIT	
turn-on time	t _{ON}	R _{LOAD} =10Ω, V _{CE} =0V→2.2V	-	0.60	1.00	ms	①	
turn-off time	t _{OFF}	R _{LOAD} =10Ω, V _{CE} =2.2V→0V	-	0.08	0.13	ms	①	
FLG output FET On-resistance	R _{FLG}	I _{FLG} =10mA, V _{OUT} =5.5V	-	15	20	Ω	③	
FLG output FET Leakage Current	I _{FOFF}	V _{IN} =5.5V, V _{FLG} =5.5V, V _{OUT} =OPEN	-	0.01	0.1	μA	③	
FLG delay time	t _{FD1}	over-current condition	6.5	7.5	8.5	ms	①	
	t _{FD2}	reverse-voltage condition	2.7	4.0	4.7	ms	①	
Reverse Current	I _{REV}	N=0V, V _{OUT} =5.5V V _{CE} =5.0V (XC8107A,X series) V _{CE} =V _{SS} (XC8107B,Y series)	-	0.1	1.0	μA	①	
Reverse Current Prevention Detect Voltage	V _{REV_D}	V _{IN} : 5.0V→4.7V V _{OUT} =5.0V	USP-6C	-	140	-	mV	①
			SOT-25 (XC8107A,B)	-	170	-		
			SOT-25 (XC8107X,Y)	-	160	-		
Thermal Shutdown Detect Temperature	T _{TSD}	Junction Temperature	-	150	-	°C	①	
Thermal Shutdown Release Temperature	T _{TSR}	Junction Temperature	-	130	-	°C	①	
Thermal Shutdown Hysteresis Width	T _{HYS}	Junction Temperature	-	20	-	°C	①	

NOTE:

Unless otherwise stated, V_{IN}=5.0V, I_{OUT}=1mA, V_{CE}=V_{IN} (XC8107A, X series) or V_{CE}=V_{SS} (XC8107B, Y series)

■ TIMING CHART

● turn-on time, turn-off time

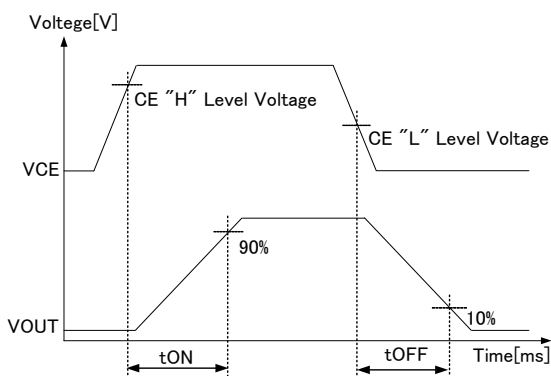

XC8107 Series, Type A, X

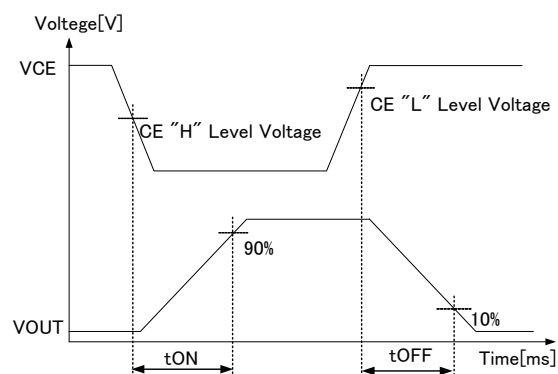

XC8107 Series, Type B, Y

TEST CIRCUITS

$C_{IN}=1.0\mu F$, $C_L=1.0\mu F$

1) CIRCUIT①

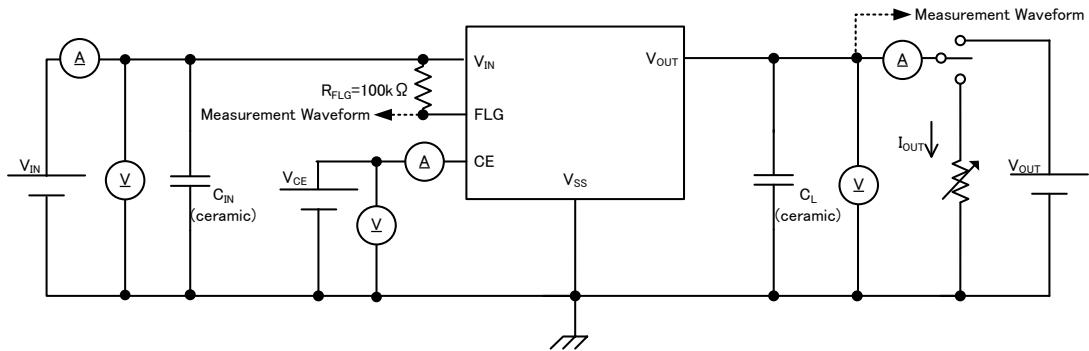

2) CIRCUIT②

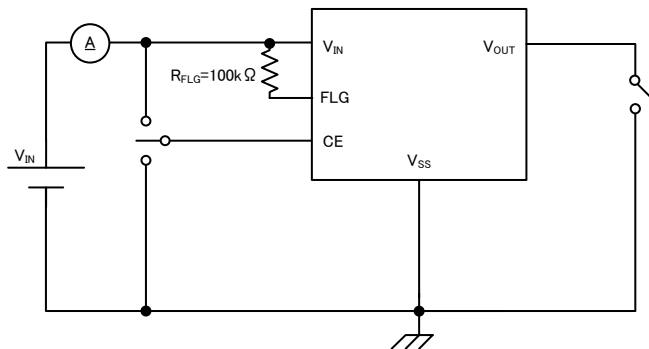

3) CIRCUIT③

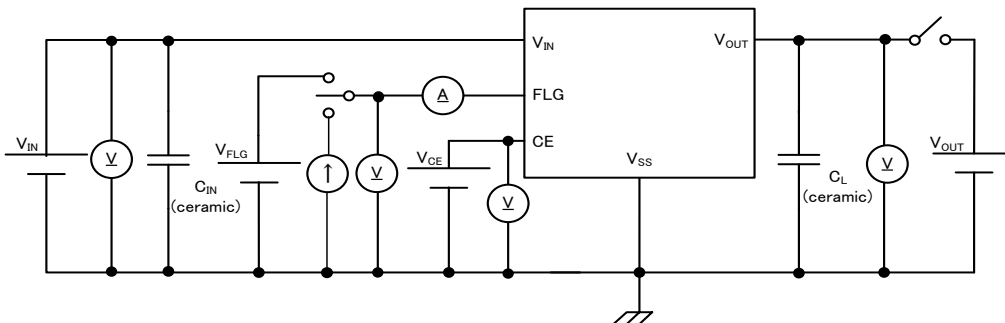

■ OPERATIONAL EXPLANATION

The XC8107 series is a P-channel MOSFET power switch IC.

The XC8107 series consists of a CE circuit, UVLO circuit, thermal shutdown circuit, current limiter circuit, reverse current prevention circuit, control block and others. The gate voltage of the power switch transistor is controlled with control block. The current limiter circuit and reverse current prevention circuit will operate based on the output voltage and output current.

(See the BLOCK DIAGRAM below)

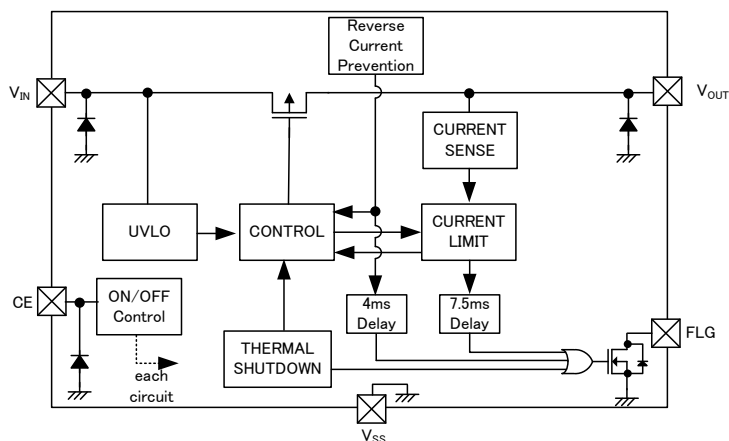

BLOCK DIAGRAM (XC8107 Series)

<CE Pin>

The voltage level which is fed to CE pin controls the status of this IC. If either “H” level or “L” level which is defined as the electrical specification is fed to CE pin, then XC8107 can operate in standard manner. However, if the middle voltage which is neither “H” level nor “L” level is fed to CE pin, the consumption current will increase due to the shoot-through current at internal circuits. Also if CE pin is open, the status of XC8107 cannot be fixed and the behavior will be unstable.

<Thermal Shutdown>

For protection against heat damage of the ICs, thermal shutdown function is built in. When the internal junction temperature reaches the temperature limit, the thermal shutdown circuit operates and the power switch transistor will turn OFF. The IC resumes its operation when the thermal shutdown function is released and the IC’s operation is automatically restored because the junction temperature drops to the level of the thermal shutdown release temperature. When the thermal shutdown circuit detects higher junction temperature than the detect temperature, the voltage level of FLG pin is low level. When the thermal shutdown circuit detects lower junction temperature than the release temperature, the thermal shutdown function is released and the voltage level of FLG pin is high level.

<Under Voltage Lockout (UVLO) >

When the V_{IN} pin voltage goes down to lower voltage than UVLO detected voltage, the power switch transistor turns OFF by UVLO function in order to prevent false output caused by unstable operation of the internal circuitry. When the V_{IN} pin voltage goes up to higher voltage than UVLO released voltage, the UVLO function is released and the power switch transistor can turn ON.

<Soft-start Function>

The soft-start circuit can reduce the in-rush current charged on the output capacitor when IC starts up. Additionally, due to the reduction of the in-rush current, the circuit can reduce the fluctuation of the input voltage as well. The soft-start time is optimized internally and defined as turn-on time. (TYP: 0.6ms)

■ OPERATIONAL EXPLANATION (Continued)

<Current limiter, short-circuit protection>

When the output current reaches the current limit value, the constant current limiter circuit activates and as a result, the output voltage goes down.

If the short circuit comes at the V_{OUT} pin, the output current is limited to the current which is specified as the short-circuit current value. If the over-current state lasts for 7.5ms (TYP.), the FLG pin changes to Low level output.

Two types are available for the current limiter circuit: an auto recovery type (product type C) and a latch off type (product type D). After the current limiter circuit activates and the FLG pin outputs low level, the operation is different between these two types.

The auto recovery type continuously limits the output current by the current limit value. When the over-current status finishes and the status of that the output current is less than the current limit value continues for 7.5ms (TYP.) or more, the voltage of FLG pin goes up "H" level again.

The latch off type turns off the power switch transistor after the FLG pin outputs Low level. The off state is maintained regardless of whether the over-current state is released.

Latch operation is released by turning off the IC with the CE pin signal and then restarting, or by lowering the input voltage below the UVLO detected voltage once and after that raising it higher than UVLO released voltage.

<Reverse current prevention>

An internal circuit is built in that prevents reverse current from the V_{OUT} pin to the V_{IN} pin. When the difference between input voltage and V_{OUT} pin voltage is higher than the detect voltage set internally, the reverse current prevention circuit activates, and the power switch transistor turns off, then the reverse current from the V_{OUT} pin to the V_{IN} pin is reduced to 0.1 μA (TYP.).

If the reverse-voltage state lasts for 4ms (TYP.), the FLG pin changes to Low level output.

Two types are available for the reverse current prevention circuit: the auto recovery type (product type C) and the latch off type (product type D). After the reverse current prevention circuit activates and the FLG pin outputs low level, the operation is different between these two types.

On the auto recovery type, when the output voltage drops below the input voltage, the reverse current prevention circuit stops immediately, and the power switch transistor turns on again. If the output voltage remains lower than the input voltage for 4ms (TYP.), the FLG pin returns to High level output.

On the latch off type, the power switch transistor remains in the off state even if the reverse voltage state is released. Latch operation is released by turning off the IC with the CE pin signal and then restarting, or by lowering the input voltage below the UVLO detected voltage once and after that raising it higher than UVLO released voltage.

■ OPERATIONAL EXPLANATION (Continued)

<Flag function>

The flag circuit is built in which monitors the state of the power switch.

The FLG pin outputs Low level when the reverse current prevention function is operating. A resistance of 10kΩ to 100kΩ is recommended for the FLG pin pull-up resistance.

Auto recovery type (product type C)

Protective function	FLG pin Low level output	Return to FLG pin High level output
Current limiter	7.5ms after over-current detection	7.5ms after over-current release
Reverse current prevention	4.0ms after reverse voltage detection	4.0ms after reverse voltage release
Thermal shutdown	Same time as overheat state is detected	Same time as overheat state is released

Latch off type (product type D)

Protective function	FLG pin Low level output	Return to FLG pin High level output
Current limiter	7.5ms after over-current detection	When latch operation is released
Reverse current prevention	4.0ms after reverse voltage detection	When latch operation is released
Thermal shutdown	Same time as overheat state is detected	Same time as overheat state is released

■ NOTES ON USE

1. For the phenomenon of temporal and transitional voltage decrease or voltage increase, the IC may be damaged or deteriorated if IC is used beyond the absolute MAX. specifications.
2. Where wiring impedance is high, operations may become unstable due to noise depending on output current.
Please keep the resistance low between V_{IN} and V_{SS} wiring in particular.
3. Please place the input capacitor (C_{IN}) and the output capacitor (C_L) as close to the IC as possible.
For the input or output capacitor, a capacitance of $1.0 \mu F$ or higher is recommended.
4. When the voltage which is higher than the maximum input voltage is fed to the V_{IN} pin, and V_{OUT} is shorted to the V_{SS} level, in this case the short circuit may cause a fatal impact to operation for the IC. Please use within the operational voltage range.
5. Torex places an importance on improving our products and its reliability.
However, by any possibility, we would request user fail-safe design and post-aging treatment on system or equipment.

TYPICAL PERFORMANCE CHARACTERISTICS

(1) UVLO detect Voltage vs. Input Voltage

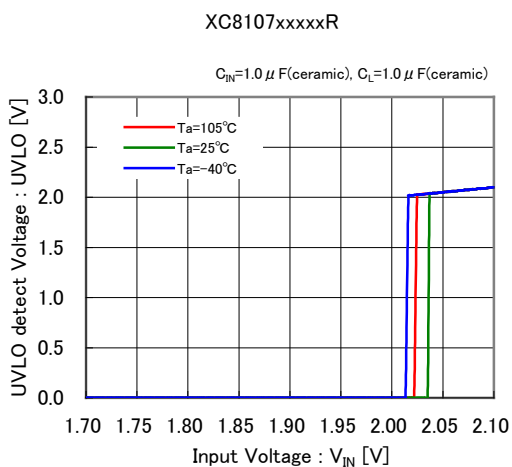

(2) UVLO release Voltage vs. Input Voltage

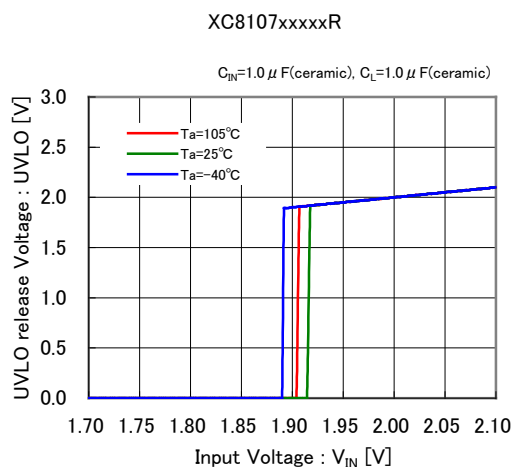

(3) UVLO threshold Voltage vs. Ambient Temperature

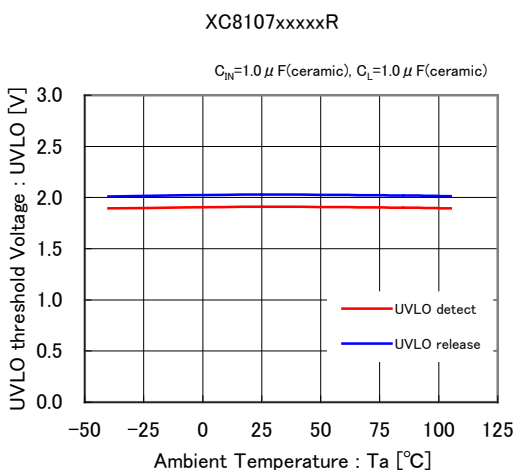

(4) Stand-by Current vs. Input Voltage

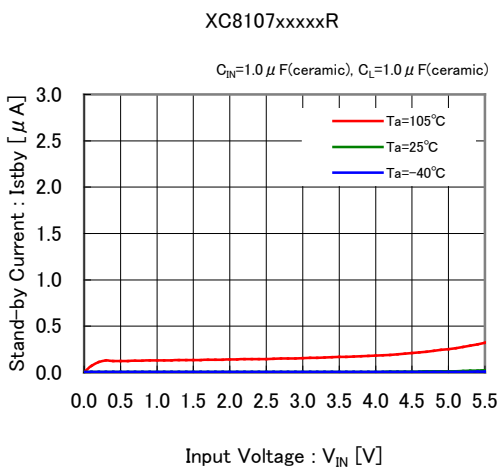

(5) Stand-by Current vs. Ambient Temperature

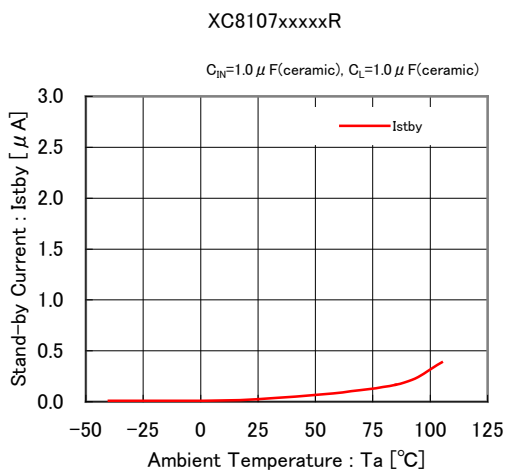

TYPICAL PERFORMANCE CHARACTERISTICS (Continued)

(6) Supply Current vs. Input Voltage (sweep up)

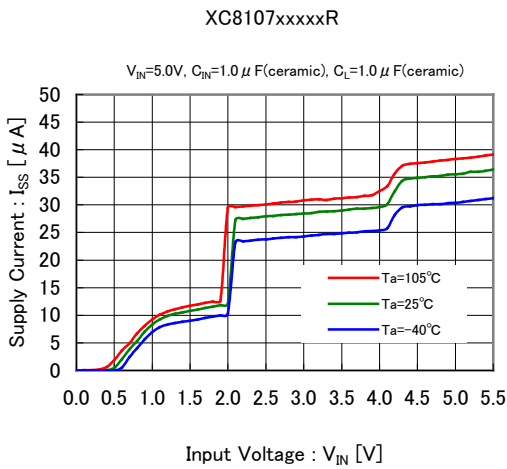

(7) Supply Current vs. Ambient Temperature

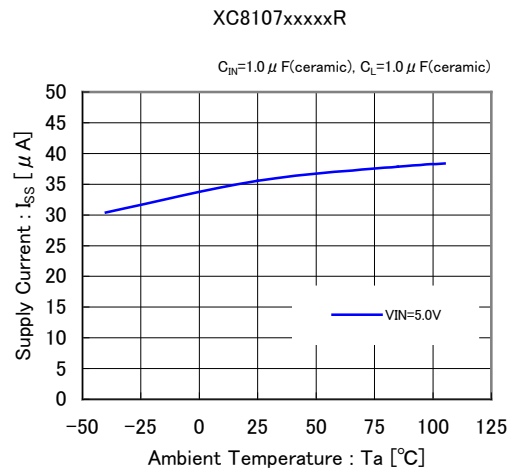

(8) CE "H" Level Voltage vs. Input Voltage

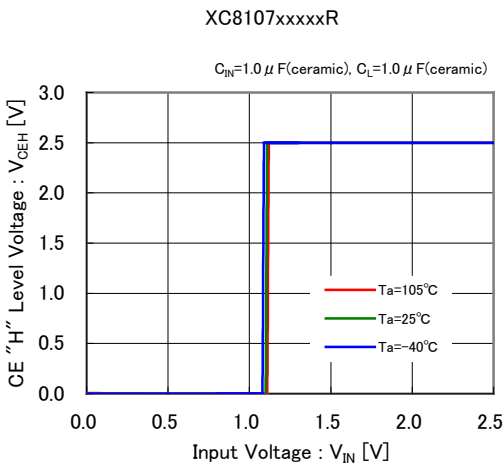

(9) CE "L" Level Voltage vs. Input Voltage

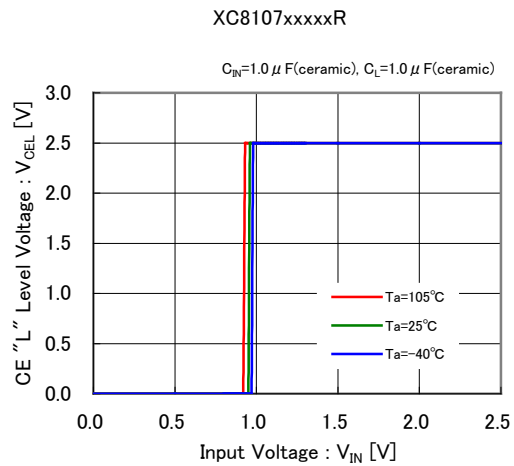

(10) CE threshold Voltage vs. Ambient Temperature

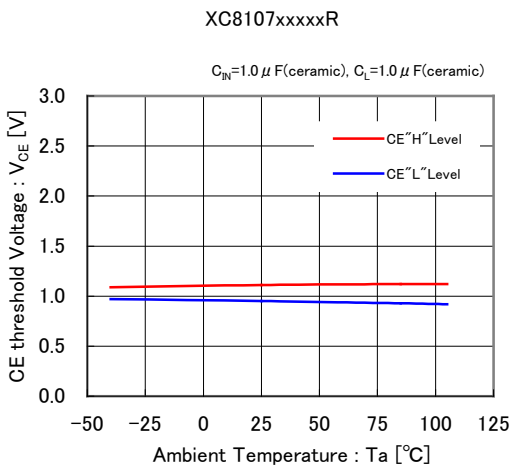

■ TYPICAL PERFORMANCE CHARACTERISTICS (Continued)

(11) On Resistance vs. Input Voltage (USP-6C)

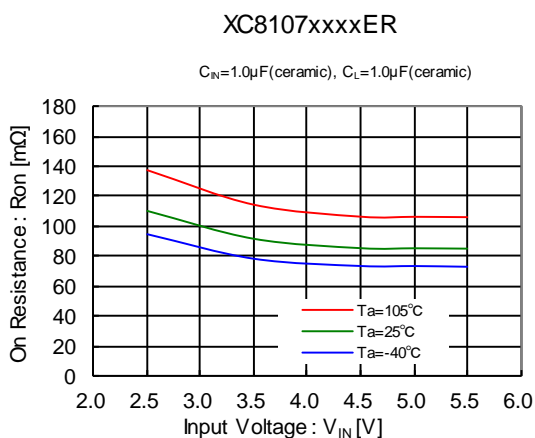

(12) On Resistance

vs. Ambient Temperature (USP-6C)

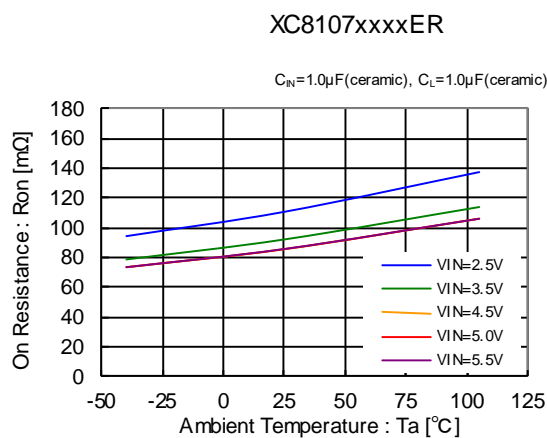

(13) On Resistance vs. Input Voltage (SOT-25:XC8107A,B)

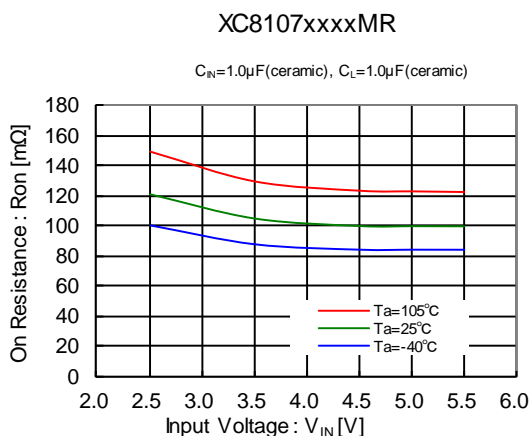

(14) On Resistance

vs. Ambient Temperature (SOT-25:XC8107A,B)

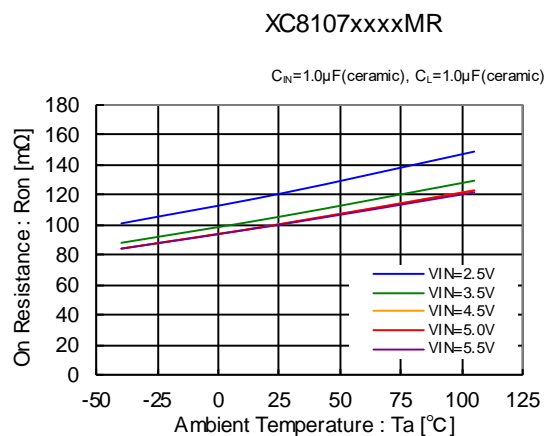

(15) On Resistance vs. Input Voltage (SOT-25:XC8107X,Y)

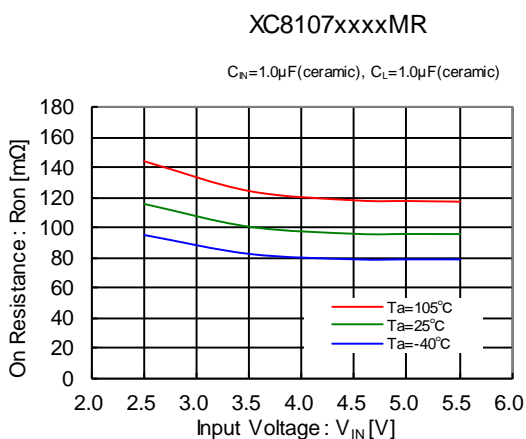

(16) On Resistance

vs. Ambient Temperature (SOT-25:XC8107X,Y)

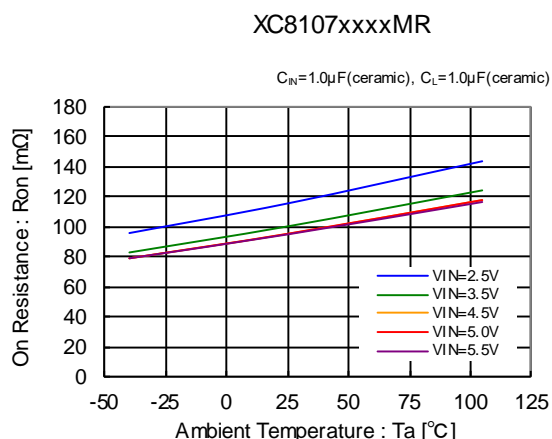

TYPICAL PERFORMANCE CHARACTERISTICS (Continued)

(17) turn-on time vs. Input Voltage

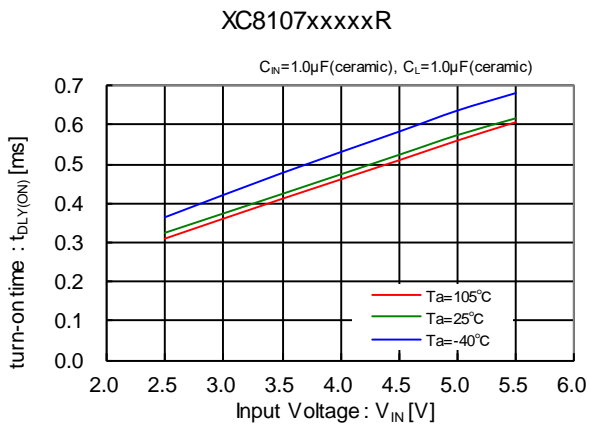

(18) turn-on time vs. Ambient Temperature

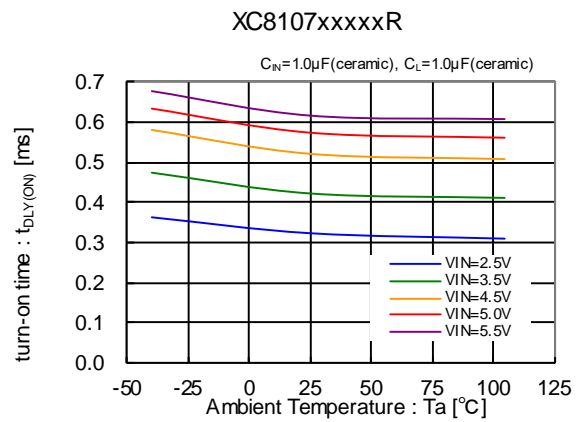

(19) turn-off time vs. Input Voltage

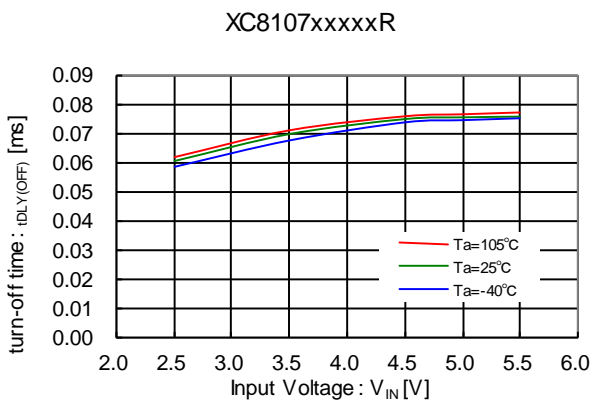

(20) turn-off time vs. Ambient Temperature

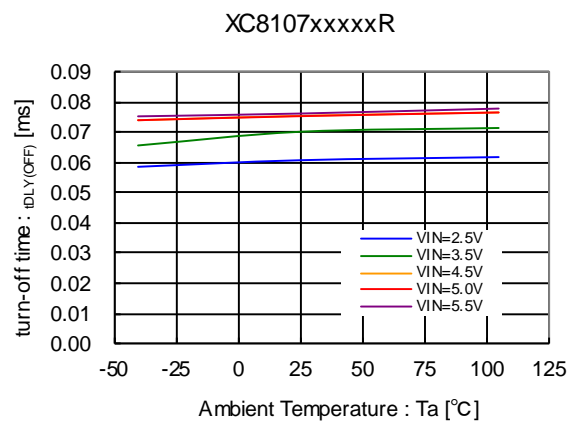

(21) FLG delay time over-current vs. Ambient Temperature

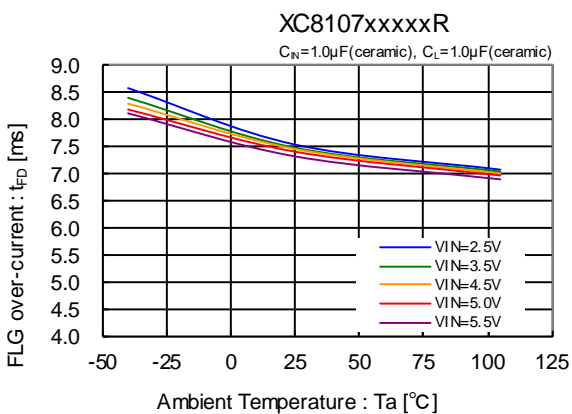

(22) FLG delay time reverse-voltage vs. Ambient Temperature

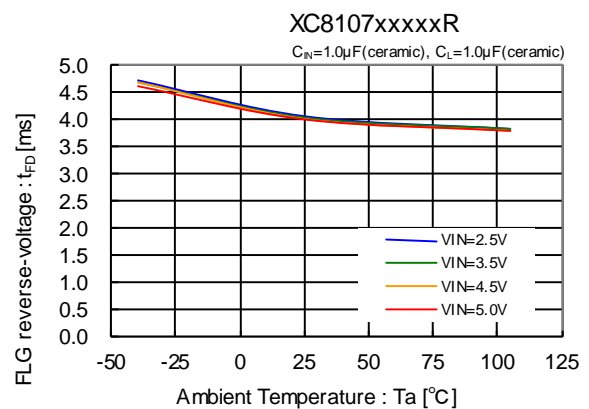

TYPICAL PERFORMANCE CHARACTERISTICS (Continued)

(23) Output Voltage vs. Output Current

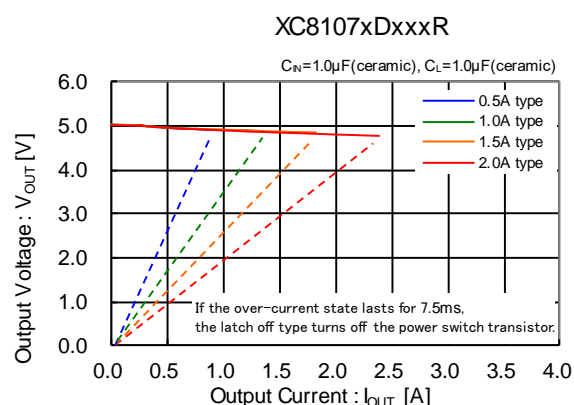
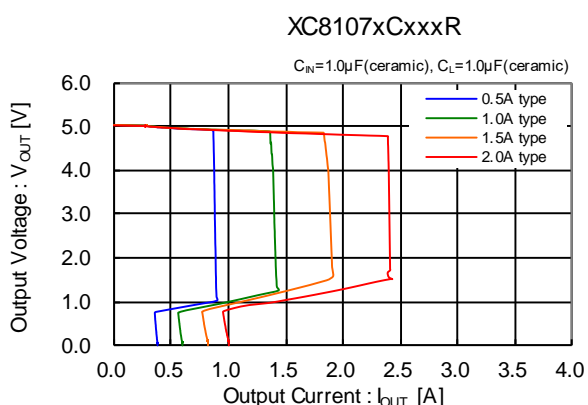

(24) turn-on Delay vs. Rise Time ($C_L=1.0\mu\text{F}$)

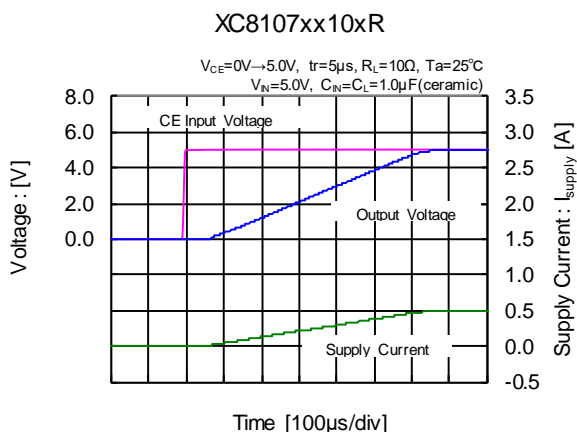

(25) turn-off Delay vs. Fall Time ($C_L=1.0\mu\text{F}$)

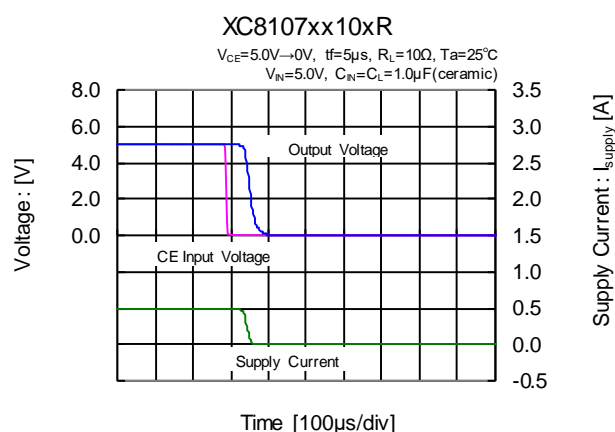

(26) turn-on Delay vs. Rise Time ($C_L=120\mu\text{F}$)

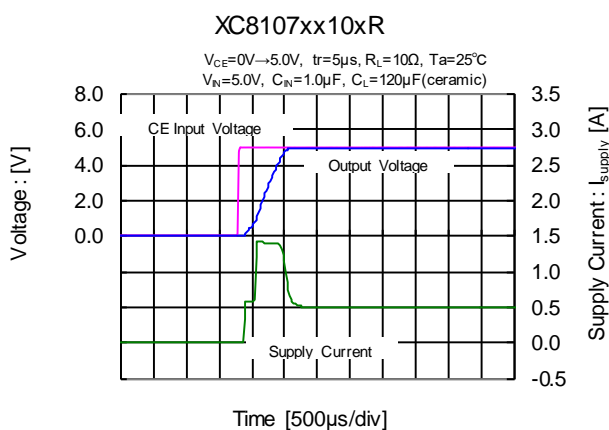

(27) turn-off Delay vs. Fall Time ($C_L=120\mu\text{F}$)

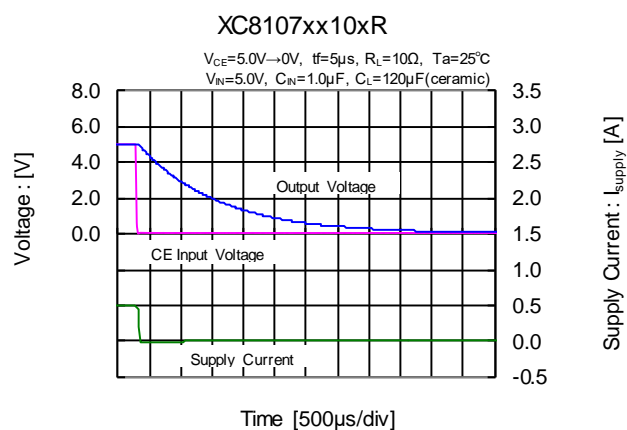

TYPICAL PERFORMANCE CHARACTERISTICS (Continued)

(28) Short Circuit Current, Device Enabled Into Short

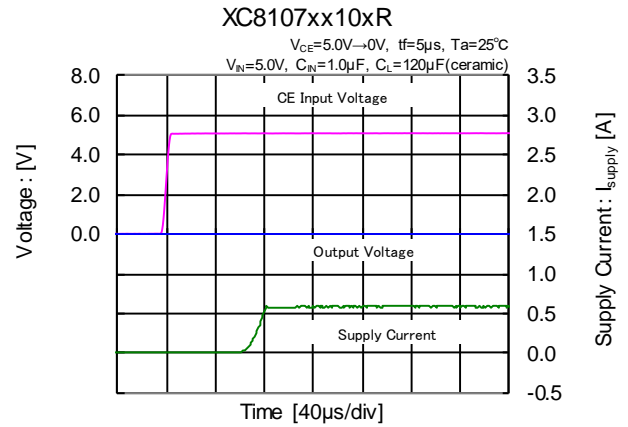
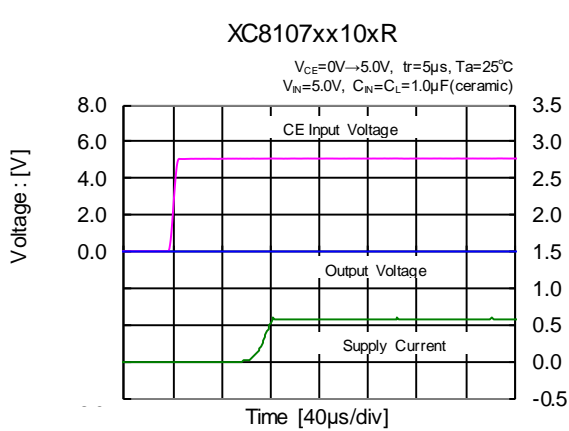

(29) Short-Circuit Transient Response

($V_{OUT}=5.0\Omega \rightarrow$ short, $C_L=1.0\mu F$)

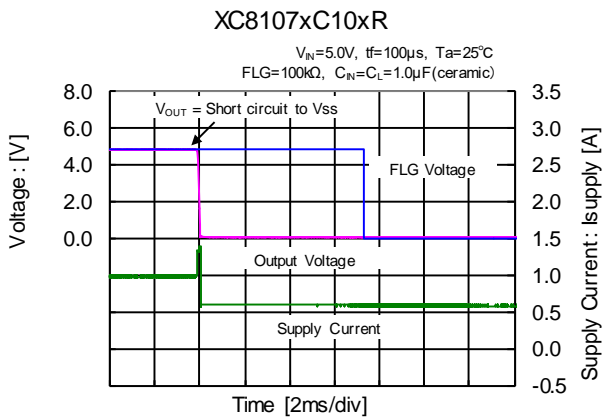

(30) Short-Circuit Transient Response

(V_{OUT} =short $\rightarrow 5.0\Omega$, $C_L=1.0\mu F$)

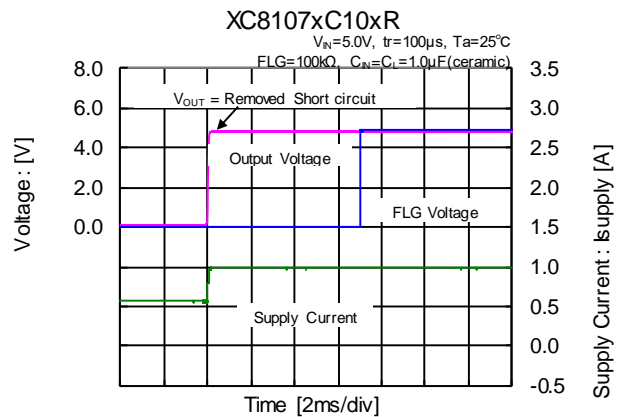

(31) Short-Circuit Transient Response

(V_{OUT} =open \rightarrow short, $C_L=1.0\mu F$)

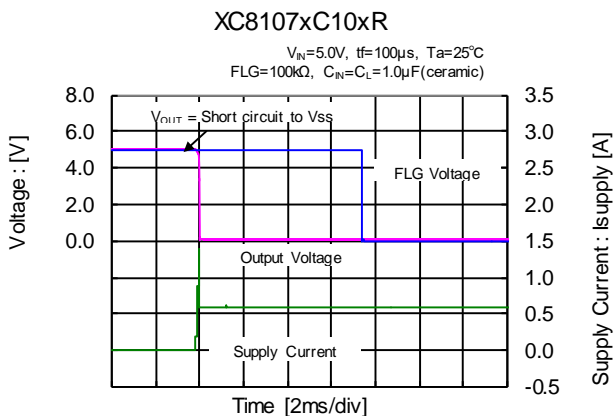

(32) Short-Circuit Transient Response

(V_{OUT} =short \rightarrow open, $C_L=1.0\mu F$)

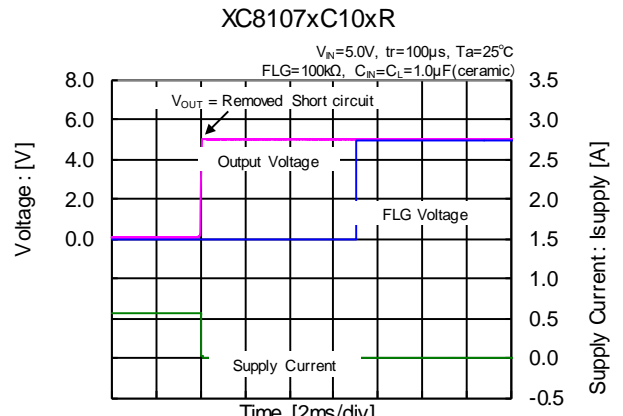

■ TYPICAL PERFORMANCE CHARACTERISTICS (Continued)

(33) Short-Circuit Transient Response

($V_{OUT}=5.0\Omega \rightarrow \text{short}$, $C_L=120\mu\text{F}$)

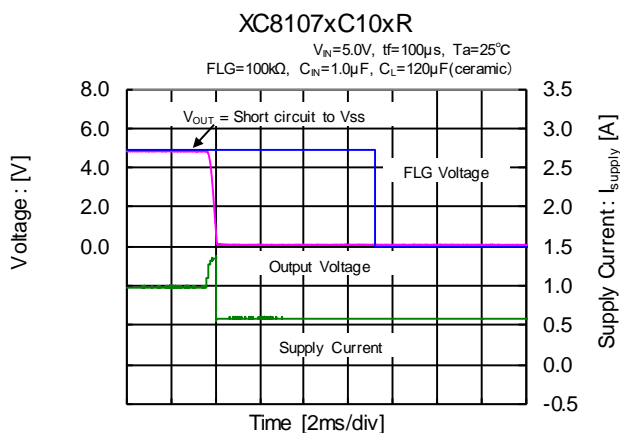

(34) Short-Circuit Transient Response

($V_{OUT}=\text{short} \rightarrow 5.0\Omega$, $C_L=120\mu\text{F}$)

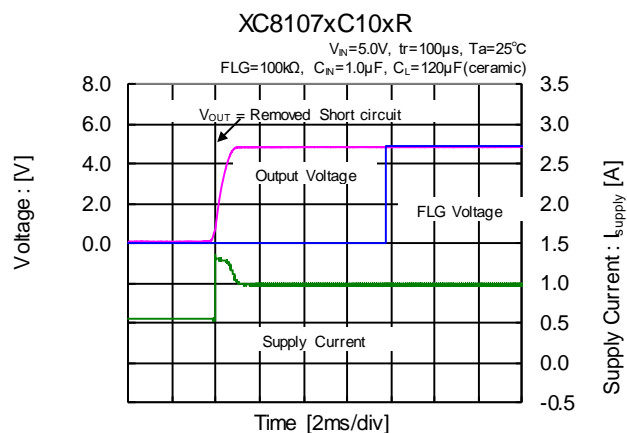

(35) Short-Circuit Transient Response

($V_{OUT}=\text{open} \rightarrow \text{short}$, $C_L=120\mu\text{F}$)

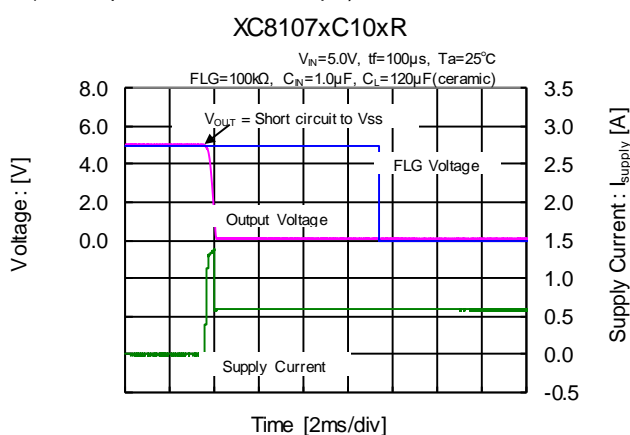

(36) Short-Circuit Transient Response

($V_{OUT}=\text{short} \rightarrow \text{open}$, $C_L=120\mu\text{F}$)

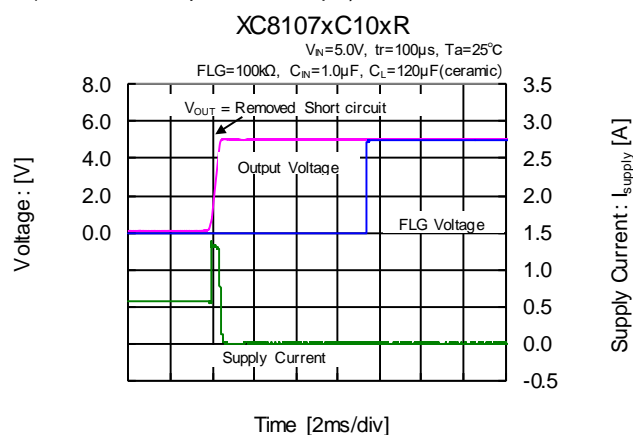

(37) UVLO Transient Response ($C_L=1.0\mu\text{F}$)

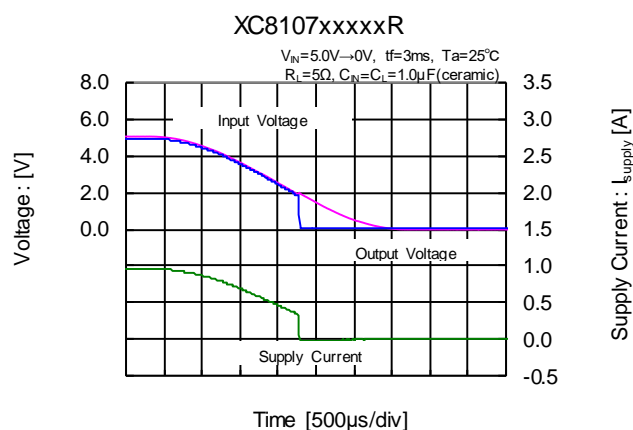
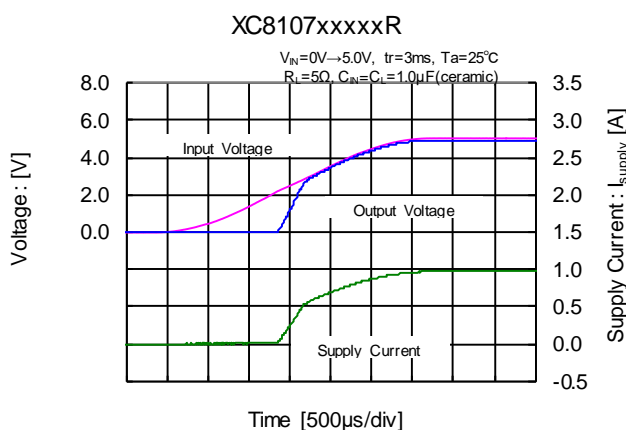

TYPICAL PERFORMANCE CHARACTERISTICS (Continued)

(38) UVLO Transient Response ($C_L=120\mu\text{F}$)

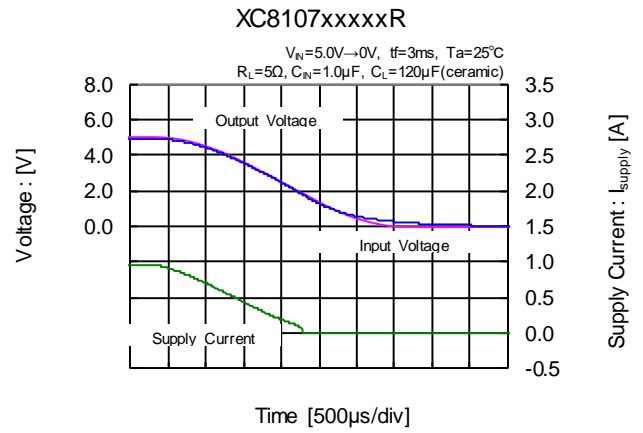
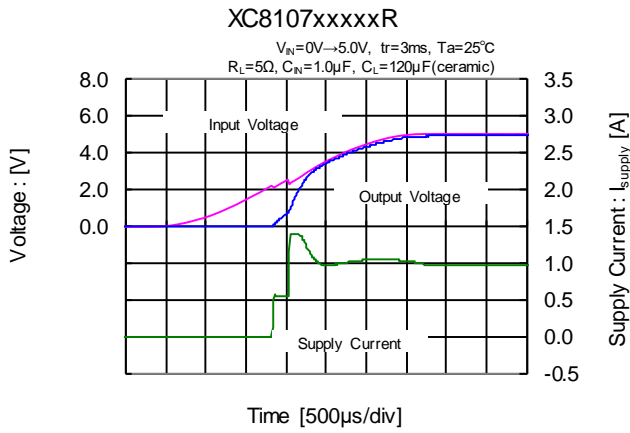

(39) Reverse Voltage Detected Voltage ($C_L=1.0\mu\text{F}$)

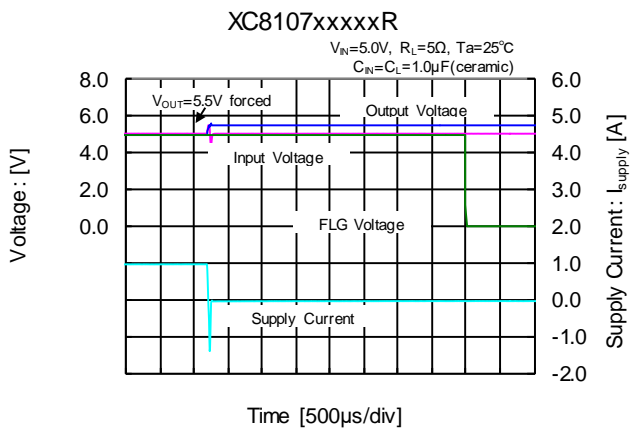

(40) Reverse Voltage Released Voltage ($C_L=1.0\mu\text{F}$)

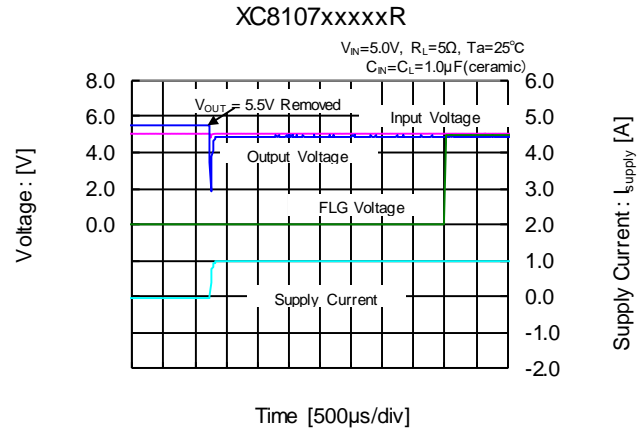

(41) Reverse Voltage Detected Voltage ($C_L=120\mu\text{F}$)

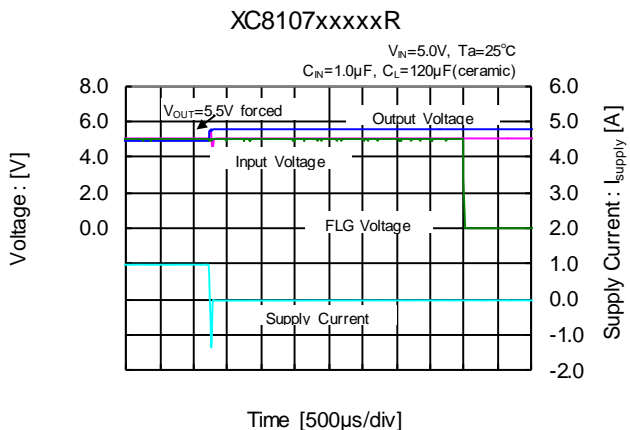

(42) Reverse Voltage Released Voltage ($C_L=120\mu\text{F}$)

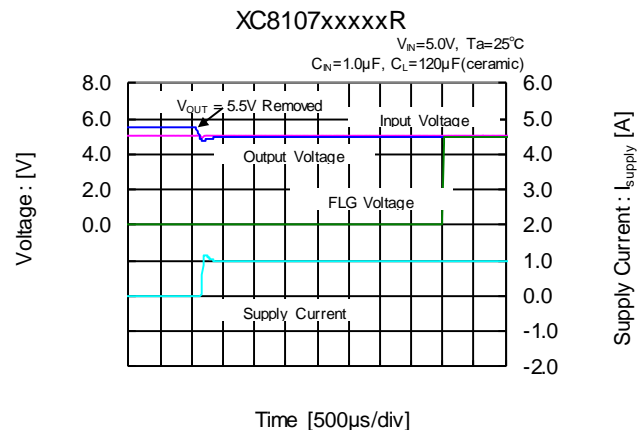

■ TYPICAL PERFORMANCE CHARACTERISTICS (Continued)

(43) CE Transient Response

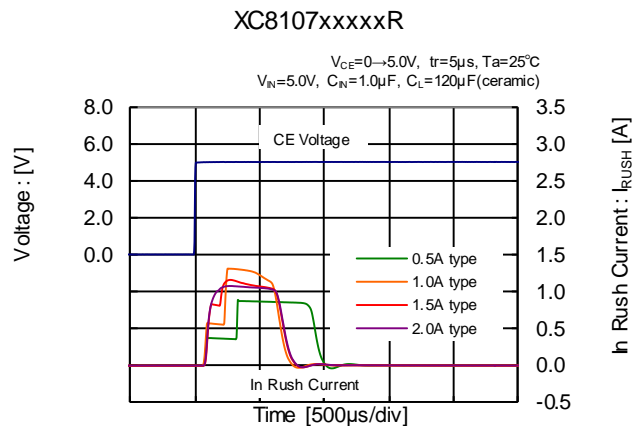
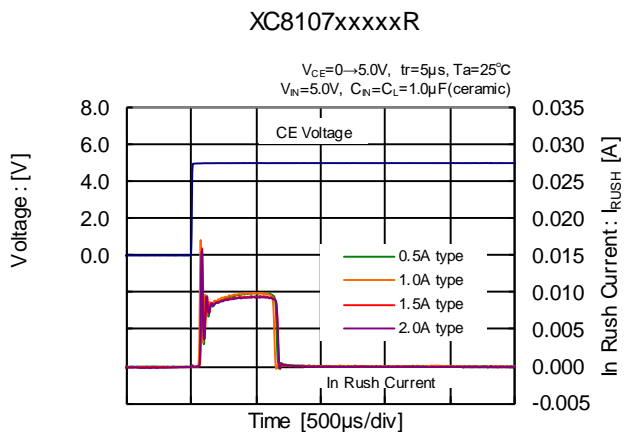

(44) Short Applied

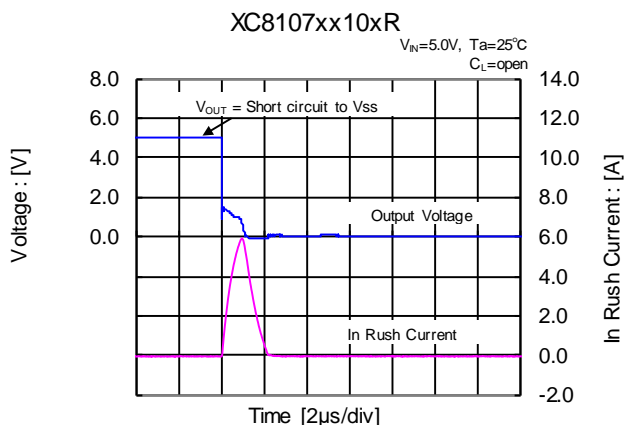

(45) Current Limit adapted time

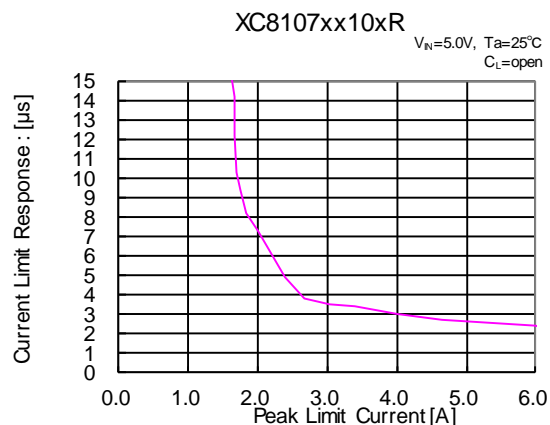

■ PACKAGING INFORMATION

For the latest package information go to, www.torexsemi.com/technical-support/packages

PACKAGE	OUTLINE / LAND PATTERN	THERMAL CHARACTERISTICS	
SOT-25	SOT-25 PKG	Standard Board	SOT-25 Power Dissipation
		JESD51-7 Board	
USP-6C	USP-6C PKG	Standard Board	USP-6C Power Dissipation
		JESD51-7 Board	

MARKING RULE

● SOT-25(Au Wire) / USP-6C(Au Wire) / SOT-25(Cu Wire)

SOT-25

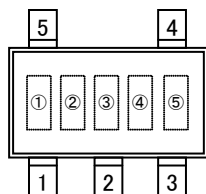

USP-6C

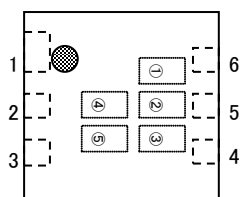

① represents products series

MARK	PRODUCT SERIES
Z	XC8107*****-G

② represents product type

MARK	Wire Type	CE LOGIC	Protection Circuits	PRODUCT SERIES
1	Au	Active High	Auto-recovery	XC8107AC****-G
2			Latch-off	XC8107AD****-G
3		Active Low	Auto-recovery	XC8107BC****-G
4	Latch-off		XC8107BD****-G	
R	Cu	Active High	Auto-recovery	XC8107XC****-G
S			Latch-off	XC8107XD****-G
T		Active Low	Auto-recovery	XC8107YC****-G
U	Latch-off		XC8107YD****G	

③ represents maximum output current

MARK	CURRENT	PRODUCT SERIES
1	0.5	XC8107**05**-G
2	1.0	XC8107**10**-G
3	1.5	XC8107**15**-G
4	2.0	XC8107**20**-G

④⑤ represents production lot number

01~09, 0A~0Z, 11~9Z, A1~A9, AA~AZ, B1~ZZ in order.

(G, I, J, O, Q, W excluded)

* No character inversion used.

1. The product and product specifications contained herein are subject to change without notice to improve performance characteristics. Consult us, or our representatives before use, to confirm that the information in this datasheet is up to date.
2. The information in this datasheet is intended to illustrate the operation and characteristics of our products. We neither make warranties or representations with respect to the accuracy or completeness of the information contained in this datasheet nor grant any license to any intellectual property rights of ours or any third party concerning with the information in this datasheet.
3. Applicable export control laws and regulations should be complied and the procedures required by such laws and regulations should also be followed, when the product or any information contained in this datasheet is exported.
4. The product is neither intended nor warranted for use in equipment of systems which require extremely high levels of quality and/or reliability and/or a malfunction or failure which may cause loss of human life, bodily injury, serious property damage including but not limited to devices or equipment used in 1) nuclear facilities, 2) aerospace industry, 3) medical facilities, 4) automobile industry and other transportation industry and 5) safety devices and safety equipment to control combustions and explosions. Do not use the product for the above use unless agreed by us in writing in advance.
5. Although we make continuous efforts to improve the quality and reliability of our products; nevertheless Semiconductors are likely to fail with a certain probability. So in order to prevent personal injury and/or property damage resulting from such failure, customers are required to incorporate adequate safety measures in their designs, such as system fail safes, redundancy and fire prevention features.
6. Our products are not designed to be Radiation-resistant.
7. Please use the product listed in this datasheet within the specified ranges.
8. We assume no responsibility for damage or loss due to abnormal use.
9. All rights reserved. No part of this datasheet may be copied or reproduced unless agreed by Torex Semiconductor Ltd in writing in advance.

TOREX SEMICONDUCTOR LTD.

单击下面可查看定价，库存，交付和生命周期等信息

[>>Torex Semiconductor\(特瑞仕\)](#)