

2ch.Step-Up/Down DC/DC Controller ICs

GreenOperation-Compatible

GENERAL DESCRIPTION

XC9502 series is PWM controlled, PWM/PFM automatic switching controlled, multi-functional, 2 channel step-up and down DC/DC controller ICs. With 0.9V of standard voltage supply internal, and using externally connected components, the output 1 voltage (step-up DC/DC controller) can be set freely within a range of 1.5V to 30V. Since the output 2 (step-down DC/DC controller) has a built-in 0.9V reference voltage (accuracy $\pm 2\%$), 0.9V can be set using external components. With a 180kHz frequency, the size of the external components can be reduced. Switching frequencies of 300kHz and 500kHz are also available as custom-designed products. The control of the XC9502 series can be switched between PWM control and PWM/PFM automatic switching control using external signals. Control switches from PWM to PFM during light loads when automatic switching is selected and the series is highly efficient from light loads through to large output currents. Noise is easily reduced with PWM control since the frequency is fixed. The series gives freedom of control selection so that control suited to the application can be selected. Soft-start time is internally set to 10msec (Output1) and offers protection against in-rush currents when the power is switched. This also prevents voltage overshoot.

APPLICATIONS

- PDA's
- Palmtop computers
- Portable audio
- Various power supplies

FEATURES

2ch DC/DC Controller

<Output 1: Step-Up DC/DC Controller>

Output Voltage Range : 1.5V ~ 30V (set by FB1 pin)
 Output Current : More than 300mA
 ($V_{IN}=1.8V, V_{OUT}=3.3V$)

Maximum Duty Cycle : 80% (TYP.)
 High Efficiency : 83% (TYP.)

<Output 2: Step-Down DC/DC Controller>

Output Voltage Range : 0.9V ~ 6.0V (set by FB2 pin)
 Output Current : 1000mA ($V_{IN}=3.3V, V_{OUT}=1.8V$)
 Maximum Duty Cycle : 100% (TYP.)
 High Efficiency : 92% (TYP.)

<Common>

Supply Voltage Range : 2.0V ~ 10.0V
 Input Voltage Range : 0.9V ~ 10.0V
 Oscillation Frequency : 180kHz ($\pm 15\%$)
 * 300kHz, 500kHz custom
 Control Method : PWM or PWM/PFM selectable
 Stand-by Function : 3.0 μ F (MAX.)
 Soft-Start Time : 10ms (internally set)
 Package : MSOP-10, USP-10
 Environmentally Friendly: : EU RoHS Compliant, Pb Free

TYPICAL APPLICATION CIRCUIT

<XC9502B092A Input : 2 cell, V_{OUT1} : 3.3V, V_{OUT2} : 1.8V >

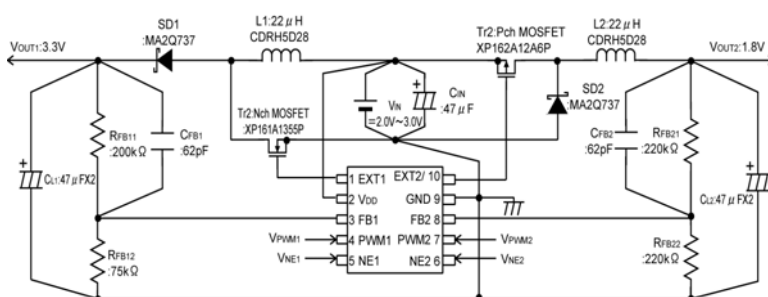

TYPICAL PERFORMANCE CHARACTERISTICS

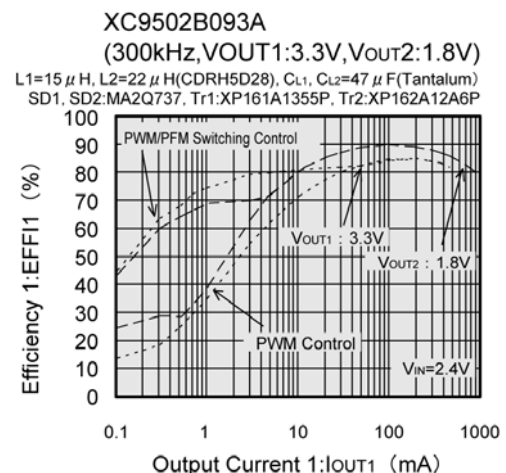

PIN CONFIGURATION

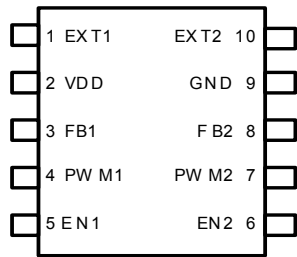

MSOP-10
(TOP VIEW)

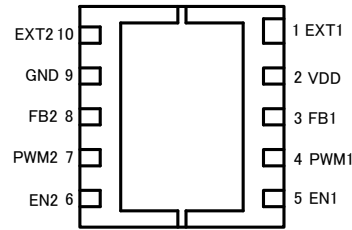

USP-10
(BOTTOM VIEW)

PIN ASSIGNMENT

| PIN NUMBER | PIN NAME | FUNCTIONS |
|------------|----------|--|
| 1 | EXT 1 | Channel 1: External Transistor Drive Pin <Connected to N-ch Power MOSFET Gate> |
| 2 | VDD | Supply Voltage |
| 3 | FB1 | Channel 1: Output Voltage Monitor Feedback Pin <Threshold value: 0.9V. Output voltage can be set freely by connecting split resistors between VOUT1 and Ground.> |
| 4 | PWM1 | Channel 1: PWM/PFM Switching Pin <Control Output 1. PWM control when connected to VDD, PWM / PFM auto switching when connected to Ground. > |
| 5 | EN1 | Channel 1: Enable Pin <Connected to Ground when Output 1 is in stand-by mode. Connected to VDD when Output 1 is active. EXT1 is low when in stand-by mode.> |
| 6 | EN2 | Channel 2: Enable Pin <Connected to Ground when Output 2 is in stand-by mode. Connected to VDD when Output 2 is active. EXT2/ is high when in stand-by mode.> |
| 7 | PWM2 | Channel 2: PWM/PFM Switching Pin <Control Output 2. PWM control when connected to VDD, PWM / PFM auto switching when connected to Ground.> |
| 8 | FB2 | Channel 2: Output Voltage Monitor Feedback Pin <Threshold value: 0.9V. Output voltage can be set freely by connecting split resistors between VOUT2 and Ground.> |
| 9 | GND | Ground |
| 10 | EXT2/ | Channel 2: External Transistor Drive Pin <Connected to P-ch Power MOSFET Gate> |

PRODUCT CLASSIFICATION

Ordering Information

XC9502 - (*)

| DESIGNATOR | ITEM | SYMBOL | DESCRIPTION |
|------------|--------------------------|--------|--------------------------|
| | Type of DC/DC Controller | B | Standard type (10 pin) |
| | Output Voltage | 09 | FB products =0, =9 fixed |
| | Oscillation Frequency | 2 | 180kHz |
| | | 3 | 300kHz (custom) |
| | | 5 | 500kHz (custom) |
| - (*) | Packages (Order Unit) | AR | MSOP-10 (1,000/Reel) |
| | | AR-G | MSOP-10 (3,000/Reel) |
| | | DR | USP-10 (3,000/Reel) |
| | | DR-G | USP-10 (3,000/Reel) |

(*) The "-G" suffix indicates that the products are Halogen and Antimony free as well as being fully RoHS compliant.

BLOCK DIAGRAM

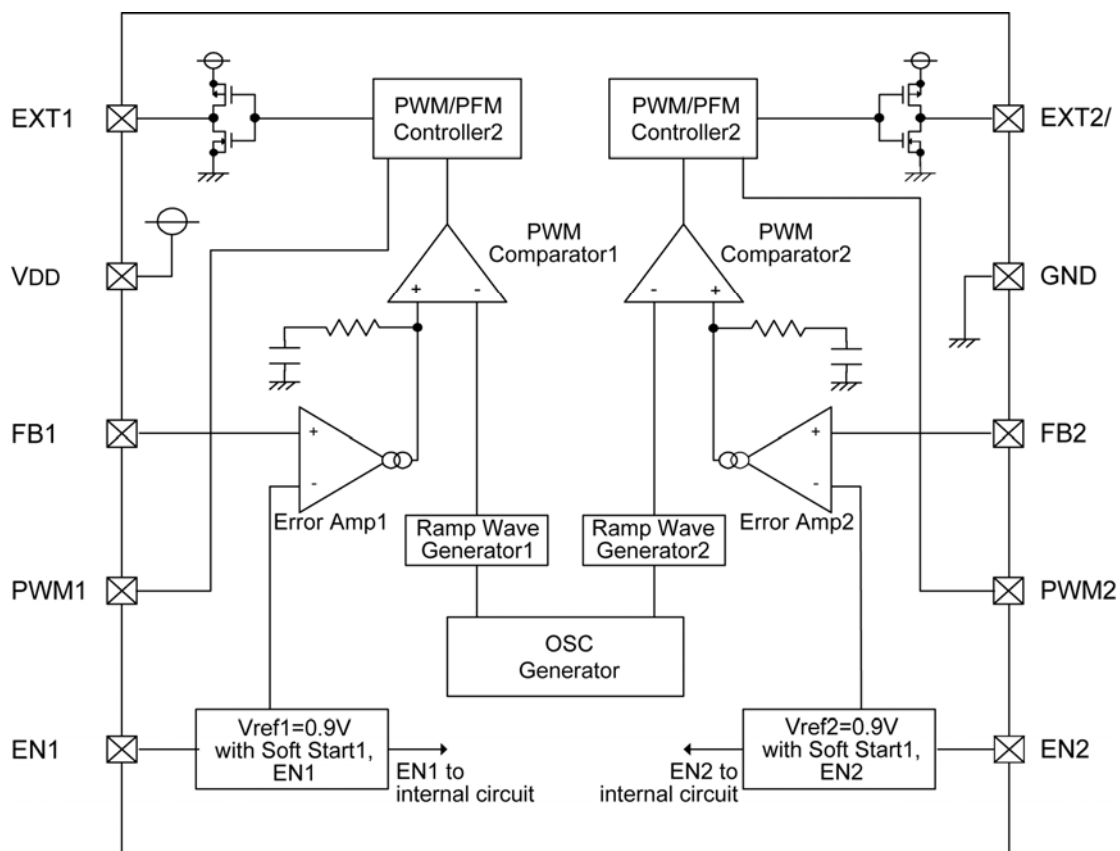

ABSOLUTE MAXIMUM RATINGS

Ta=25

| PARAMETER | SYMBOL | RATINGS | UNITS |
|-----------------------------|---------|-------------------|-------|
| VDD Pin Voltage | VDD | - 0.3 ~ 12.0 | V |
| FB1, 2 Pin Voltage | VFB | - 0.3 ~ 12.0 | V |
| EN1, 2 Pin Voltage | VEN | - 0.3 ~ 12.0 | V |
| PWM1, 2 Pin Voltage | VPWM | - 0.3 ~ 12.0 | V |
| EXT1, 2 Pin Voltage | VEXT | - 0.3 ~ VDD + 0.3 | V |
| EXT1, 2 Pin Current | IEXT | ± 100 | mA |
| Power Dissipation | MSOP-10 | Pd | mW |
| | USP-10 | | |
| Operating Temperature Range | Topr | - 40 ~ + 85 | °C |
| Storage Temperature Range | Tstg | - 55 ~ + 125 | °C |

* Voltage is all ground standardized.

ELECTRICAL CHARACTERISTICS

XC9502B092 Common Characteristics

(FOSC=180kHz)

Ta=25

| PARAMETER | SYMBOL | CONDITIONS | MIN. | TYP. | MAX. | UNITS | CIRCUIT |
|---------------------------|---------|--------------------------|-------|------|-------|-------|---------|
| Supply Voltage (*1) | VDD | | 2.0 | - | 10.0 | V | |
| Maximum Input Voltage | VIN | | 10.0 | - | - | V | |
| Output Voltage Range (*3) | VOUTSET | VDD 2.0V, IOUT1,2=1mA | VOUT1 | 0.9 | - | - | V |
| | | VDD VOUT1 | VOUT2 | 0.9 | - | VIN | V |
| | | VIN 0.9V, IOUT1,2=1mA | VOUT1 | 2.0 | - | 10.0 | V |
| | | VDD=VOUT1 | VOUT2 | 0.9 | - | VIN | V |
| Supply Current 1 | IDD1 | FB1, 2=0V | - | 70 | 160 | μA | |
| Supply Current 1-1 | IDD1-1 | EN1=3.0V, EN2=0V, FB1=0V | - | 60 | 120 | μA | |
| Supply Current 1-2 | IDD1-2 | EN2=3.0V, EN1=0V, FB2=0V | - | 50 | 110 | μA | |
| Supply Current 1-3 | IDD1-3 | FB1=0V, FB2=1.0V | - | 70 | 160 | μA | |
| Supply Current 1-4 | IDD1-4 | FB1=1.0V, FB2=0V | - | 60 | 130 | μA | |
| Supply Current 2 | IDD2 | FB1, 2=1.0V | - | 60 | 130 | μA | |
| Stand-by Current | ISTB | Same as IDD1, EN1=EN2=0V | - | 1.0 | 3.0 | μA | |
| Oscillation Frequency | FOSC | Same as IDD1 | 153 | 180 | 207 | kHz | |
| EN1, 2 "High" Voltage | VENH | FB1, 2=0V | 0.65 | - | - | V | |
| EN1, 2 "Low" Voltage | VENL | FB1, 2=0V | - | - | 0.20 | V | |
| EN1, 2 "High" Current | IENH | EN1, 2=3.0V | - | - | 0.50 | μA | |
| EN1, 2 "Low" Current | IENL | EN1, 2=0V, FB1, 2=3.0V | - | - | -0.50 | μA | |
| PWM1, 2 "High" Current | IPWMH | FB1, 2=3.0V, PWM=3.0V | - | - | 0.50 | μA | |
| PWM1, 2 "Low" Current | IPWML | FB1, 2=3.0V, PWM=0V | - | - | -0.50 | μA | |
| FB1, 2 "High" Current | IFBH | FB1, 2=3.0V | - | - | 0.50 | μA | |
| FB1, 2 "Low" Current | VFBL | FB1, 2=1.0V | - | - | -0.50 | μA | |

Unless otherwise stated, VDD=3.0V, PWM1, 2=3.0V, EN1, 2 =3.0V

Output 1 Characteristics: Step-Up Controller

Ta=25

| PARAMETER | SYMBOL | CONDITIONS | MIN. | TYP. | MAX. | UNITS | CIRCUIT |
|-------------------------------|---------|---|-------|-------|-------|-------|---------|
| FB1 Voltage | VFB1 | VDD=3.0V, VIN=1.5V, IOUT1=10mA | 0.882 | 0.900 | 0.918 | V | |
| Operation Start Voltage1 (*2) | VST1-1 | Using Tr: 2SD1628 IOUT1=1.0mA, RFB11=200k, RFB12=75k | - | - | 0.9 | V | |
| | | VDD VOUT1: IOUT1=1mA | - | - | 2.0 | V | |
| Oscillation Start-up Voltage1 | VST2-1 | FB1=0V | - | - | 0.8 | V | |
| Maximum Duty Ratio1 | MAXDTY1 | Same as IDD1 | 75 | 80 | 85 | % | |
| Minimum Duty Ratio1 | MINDTY1 | Same as IDD2 | - | - | 0 | % | |
| PFM Duty Ratio1 | PFMDTY1 | No Load, VPWM1=0V | 22 | 30 | 38 | % | |
| Efficiency 1 (*4) | EFFI1 | IOUT1=30mA, N-ch MOSFET: XP161A1355P | - | 85 | - | % | |
| Soft-Start Time1 | TSS1 | VOUT1 x 0.95V, EN1=0V 0.65V | 5.0 | 10.0 | 20.0 | ms | |
| EXT1 "High" ON Resistance | REXTBH1 | FB1=0, EXT1=VDD-0.4V | - | 28 | 47 | | |
| EXT1 "Low" ON Resistance | REXTBL1 | EN1=FB2=0V, EXT1=0.4V | - | 22 | 30 | | |
| PWM1 "High" Voltage | VPWMH1 | No Load | 0.65 | - | - | V | |
| PWM1 "Low" Voltage | VPWML1 | No Load | - | - | 0.20 | V | |

Unless otherwise stated, VDD=EN1=PWM1=3.0V, EN2=PWM2=GND, EXT2=OPEN, FB2=OPEN, VIN=1.8V

Output 2 Characteristics: Step-Down Controller

Ta=25

| PARAMETER | SYMBOL | CONDITIONS | MIN. | TYP. | MAX. | UNITS | CIRCUIT |
|---------------------------|---------|---|-------|-------|-------|-------|---------|
| FB 2 Voltage | VFB2 | VIN=3.0V, IOUT2=10mA | 0.882 | 0.900 | 0.918 | V | |
| Minimum Operating Voltage | VINmin | | - | - | 2.0 | V | |
| Maximum Duty Ratio 2 | MAXDTY2 | Same as IDD1 | 100 | - | - | % | |
| Minimum Duty Ratio 2 | MINDTY2 | Same as IDD2 | - | - | 0 | % | |
| PFM Duty Ratio 2 | PFMDTY2 | No Load, VPWM2=0V | 22 | 30 | 38 | % | |
| Efficiency 2 (*4) | EFFI2 | IOUT2=250mA P-ch MOSFET: XP162A12A6P | - | 92 | - | % | |
| Soft-Start Time 2 | TSS2 | VOUT2 x 0.95V, EN2=0V 0.65V | 5.0 | 10.0 | 20.0 | ms | |
| EXT2 "High" ON Resistance | REXTBH2 | EN2=0, EXT2=VDD-0.4V | - | 28 | 47 | | |
| EXT2 "Low" ON Resistance | REXTBL2 | FB2=0V, EXT2=0.4V | - | 22 | 30 | | |
| PWM2 "High" Voltage | VPWMH2 | No Load | 0.65 | - | - | V | |
| PWM2 "Low" Voltage | VPWML2 | No Load | - | - | 0.20 | V | |

Unless otherwise stated, VDD=EN2=PWM2=3.0V, PWM1=EN1=GND, EXT1=OPEN, FB1=OPEN, VIN=5.0V

NOTE: *1 : Although the IC's step-up operations start from a VDD of 0.8V, the output voltage and switching frequency are stabilized at VDD 2.0V. Therefore, a VDD of more than 2.0V is recommended when VDD is supplied from VIN or other power sources.

*2 : Although the IC's switching operations start from a VIN of 0.9V, the IC's power supply pin (VDD) and output voltage monitor pin (FB1) should be connected to VOUT1. With operations from VIN=0.9V, the 2nd channel's (output 2) EN2 pin should be set to chip disable. Once output voltage VOUT1 is more than 2.0V, the EN2 pin should be set to chip enable.

*3 : Please be careful not to exceed the breakdown voltage level of the external components.

*4 : $EFFI = \left[\frac{(\text{Output voltage}) \times (\text{Output current})}{(\text{Input voltage}) \times (\text{Input current})} \right] \times 100$

ELECTRICAL CHARACTERISTICS (Continued)

XC9502B093 Common Characteristics

(FOSC=300kHz)

Ta=25

| PARAMETER | SYMBOL | CONDITIONS | MIN. | TYP. | MAX. | UNITS | CIRCUIT |
|---------------------------|---------|--------------------------|-------|------|-------|-------|---------|
| Supply Voltage (*1) | VDD | | 2.0 | - | 10.0 | V | |
| Maximum put Voltage | VIN | | 10.0 | - | - | V | |
| Output Voltage Range (*3) | VOUTSET | VDD 0V, IOUT1,2=1mA | VOUT1 | 0.9 | - | - | V |
| | | VDD VOUT1 | VOUT2 | 0.9 | - | VIN | V |
| | | VIN 0.9V, IOUT1,2=1mA | VOUT1 | 2.0 | - | 10.0 | V |
| | | VDD=VOUT1 | VOUT2 | 0.9 | - | VIN | V |
| Supply Current 1 | IDD1 | FB1, 2=0V | - | 100 | 190 | μA | |
| Supply Current 1-1 | IDD1-1 | EN1=3.0V, EN2=0V, FB1=0V | - | 80 | 150 | μA | |
| Supply Current 1-2 | IDD1-2 | EN2=3.0V, EN1=0V, FB2=0V | - | 60 | 120 | μA | |
| Supply Current 1-3 | IDD1-3 | FB1=0V, FB2=1.0V | - | 100 | 190 | μA | |
| Supply Current 1-4 | IDD1-4 | FB1=1.0V, FB2=0V | - | 70 | 150 | μA | |
| Supply Current 2 | IDD2 | FB1, 2=1.0V | - | 70 | 150 | μA | |
| Stand-by Current | ISTB | Same as IDD1, EN1=EN2=0V | - | 1.0 | 3.0 | μA | |
| Oscillation Frequency | FOSC | Same as IDD1 | 255 | 300 | 345 | kHz | |
| EN1, 2 "High" Voltage | VENH | FB1, 2=0V | 0.65 | - | - | V | |
| EN1, 2 "Low" Voltage | VENL | FB1, 2=0V | - | - | 0.20 | V | |
| EN1, 2 "High" Current | IENH | EN1, 2=3.0V | - | - | 0.50 | μA | |
| EN1, 2 "Low" Current | IENL | EN1, 2=0V, FB1, 2=3.0V | - | - | -0.50 | μA | |
| PWM1, 2 "High" Current | IPWMH | FB1, 2=3.0V, PWM=3.0V | - | - | 0.50 | μA | |
| PWM1, 2 "Low" Current | IPWML | FB1, 2=3.0V, PWM=0V | - | - | -0.50 | μA | |
| FB1, 2 "High" Current | IFBH | FB1, 2=3.0V | - | - | 0.50 | μA | |
| FB1, 2 "Low" Current | VFBL | FB1, 2=1.0V | - | - | -0.50 | μA | |

Unless otherwise stated. VDD=3.0V. PWM1,2=3.0V. EN1, 2=3.0V

Output 1 Characteristics: Step-Up Controller

Ta=25

| PARAMETER | SYMBOL | CONDITIONS | MIN. | TYP. | MAX. | UNITS | CIRCUIT |
|------------------------------|---------|---|-------|-------|-------|-------|---------|
| FB1 Voltage | VFB1 | VDD=3.0V, VIN=1.5V, IOUT1=10mA | 0.882 | 0.900 | 0.918 | V | |
| Operation Start Voltage (*2) | VST1-1 | Using Tr: 2SD1628 IOUT1=1.0mA, RFB11=200k, RFB12=75k | - | - | 0.9 | V | |
| | | VDD VOUT1: IOUT1=1mA | - | - | 2.0 | V | |
| Oscillation Start Voltage2 | VST2-1 | FB1=0V | - | - | 0.8 | V | |
| Maximum Duty Ratio | MAXDTY1 | Same as IDD1 | 75 | 80 | 85 | % | |
| Minimum Duty Ratio | MINDTY1 | Same as IDD2 | - | - | 0 | % | |
| PFM Duty Ratio | PFMDTY1 | No Load, VPWM1=0V | 22 | 30 | 38 | % | |
| Efficiency (*4) | EFFI1 | IOUT=130mA N-ch MOSFET: XP161A1355P | - | 85 | - | % | |
| Soft-Start Time | TSS1 | VOUT1 x 0.95V, EN1=0V 0.65V | 5.0 | 10.0 | 20.0 | ms | |
| EXT1 "High" ON Resistance | REXTBH1 | FB1=0, EXT1=VDD-0.4V | - | 28 | 47 | | |
| EXT1 "Low" ON Resistance | REXTBL1 | EN1=FB2=0V, EXT1=0.4V | - | 22 | 30 | | |
| PWM1 "High" Voltage | VPWMH1 | No Load | 0.65 | - | - | V | |
| PWM1 "Low" Voltage | VPWML1 | No Load | - | - | 0.20 | V | |

Unless otherwise stated, VDD=EN1=PWM1=3.0V, EN2=PWM2=GND, EXT2=OPEN, FB2=OPEN, VIN=1.8V

Output 2 Characteristics: Step-Down Controller

Ta=25

| PARAMETER | SYMBOL | CONDITIONS | MIN. | TYP. | MAX. | UNITS | CIRCUIT |
|---------------------------|---------|---|-------|-------|-------|-------|---------|
| FB2 Voltage | VFB2 | VIN=3.0V, IOUT2=10mA | 0.900 | 0.900 | 0.900 | V | |
| Minimum Operating Voltage | VINmin | | - | - | 2.0 | V | |
| Maximum Duty Ratio 2 | MAXDTY2 | Same as IDD1 | 100 | - | - | % | |
| Minimum Duty Ratio 2 | MINDTY2 | Same as IDD2 | - | - | 0 | % | |
| PFM Duty Ratio 2 | PFMDTY2 | No Load, VPWM2=0V | 22 | 30 | 38 | % | |
| Efficiency 2 (*4) | EFFI2 | IOUT2=250mA P-ch MOSFET: XP162A12A6P | - | 92 | - | % | |
| Soft-Start Time 2 | TSS2 | VOUT2 x 0.95V, EN2=0V 0.65V | 5.0 | 10.0 | 20.0 | ms | |
| EXT2 "High" ON Resistance | REXTBH2 | EN2=0, EXT2=VDD-0.4V | - | 28 | 47 | | |
| EXT2 "Low" ON Resistance | REXTBL2 | FB2=0V, EXT2=0.4V | - | 22 | 30 | | |
| PWM2 "High" Voltage | VPWMH2 | No Load | 0.7 | - | - | V | |
| PWM2 "Low" Voltage | VPWML2 | No Load | - | - | 0.20 | V | |

Unless otherwise stated, VDD=EN2=PWM2=3.0V, PWM1=EN1=GND, EXT1=OPEN, FB1=OPEN, VIN=5.0V

NOTE: *1 : Although the IC's step-up operations start from a VDD of 0.8V, the output voltage and switching frequency are stabilized at VDD 2.0V. Therefore, a VDD of more than 2.0V is recommended when VDD is supplied from VIN or other power sources.

*2 : Although the IC's switching operations start from a VIN of 0.9V, the IC's power supply pin (VDD) and output voltage monitor pin (FB1) should be connected to VOUT1. With operations from VIN=0.9V, the 2nd channel's (output 2) EN2 pin should be set to chip disable. Once output voltage VOUT1 is more than 2.0V, the EN2 pin should be set to chip enable.

*3 : Please be careful not to exceed the breakdown voltage level of the external components.

*4 : $EFFI = \left\{ \frac{(\text{output voltage}) \times (\text{output current})}{(\text{input voltage}) \times (\text{input current})} \right\} \times 100$

ELECTRICAL CHARACTERISTICS (Continued)

| XC9502B095 Common Characteristics | | (FOSC=500kHz) | | | Ta=25 | | |
|-----------------------------------|---------|--------------------------|-------|------|-------|-------|---------|
| PARAMETER | SYMBOL | CONDITIONS | MIN. | TYP. | MAX. | UNITS | CIRCUIT |
| Supply Voltage (*1) | VDD | | 2.0 | - | 10.0 | V | |
| Maximum Input Voltage | VIN | | 10.0 | - | - | V | |
| Output Voltage Range (*3) | VOUTSET | VDD 2.0V, IOUT1, 2=1mA | VOUT1 | 0.9 | - | - | V |
| | | VDD≠VOUT1 | VOUT2 | 0.9 | - | VIN | V |
| | | VIN 0.9V, IOUT1, 2=1mA | VOUT1 | 2.0 | - | 10.0 | V |
| | | VDD=VOUT1 | VOUT2 | 0.9 | - | VIN | V |
| Supply Current 1 | IDD1 | FB1, 2=0V | - | 130 | 250 | μA | |
| Supply Current 1-1 | IDD1-1 | EN1=3.0V, EN2=0V, FB1=0V | - | 110 | 220 | μA | |
| Supply Current 1-2 | IDD1-2 | EN2=3.0V, EN1=0V, FB2=0V | - | 80 | 150 | μA | |
| Supply Current 1-3 | IDD1-3 | FB1=0V, FB2=1.0V | - | 130 | 240 | μA | |
| Supply Current 1-4 | IDD1-4 | FB1=1.0V, FB2=0V | - | 90 | 190 | μA | |
| Supply Current 2 | IDD2 | FB1, 2=1.0V | - | 90 | 190 | μA | |
| Stand-by Current | ISTB | Same as IDD1, EN1=EN2=0V | - | 1.0 | 3.0 | μA | |
| Oscillation Frequency | FOSC | Same as IDD1 | 425 | 500 | 575 | kHz | |
| EN1, 2 "High" Voltage | VENH | FB1, 2=0V | 0.65 | - | - | V | |
| EN1, 2 "Low" Voltage | VENL | FB1, 2=0V | - | - | 0.20 | V | |
| EN1, 2 "High" Current | IENH | EN1, 2=3.0V | - | - | 0.50 | μA | |
| EN1, 2 "Low" Current | IENL | EN1, 2=0V, FB1, 2=3.0V | - | - | -0.50 | μA | |
| PWM1, 2 "High" Current | IPWMH | FB1, 2=3.0V, PWM=3.0V | - | - | 0.50 | μA | |
| PWM1, 2 "Low" Current | IPWML | FB1, 2=3.0V, PWM=0V | - | - | -0.50 | μA | |
| FB1, 2 "High" Current | IFBH | FB1, 2=3.0V | - | - | 0.50 | μA | |
| FB1, 2 "Low" Current | VFBL | FB1, 2=1.0V | - | - | -0.50 | μA | |

Unless otherwise stated, VDD=3.0V, PWM1, 2=3.0V, EN1, 2=3.0V

Output 1 Characteristics: Step-Up Controller

Ta=25

| PARAMETER | SYMBOL | CONDITIONS | MIN. | TYP. | MAX. | UNITS | CIRCUIT |
|--------------------------------|---------|---|-------|-------|-------|-------|---------|
| FB 1 Voltage | VFB1 | VDD=3.0V, VIN=1.5V, IOUT1=10mA | 0.882 | 0.900 | 0.918 | V | |
| Operation Start Voltage 1 (*2) | VST1-1 | Using Tr: 2SD1628 IOUT1=1.0mA, RFB11=200k, RFB12=75k | - | - | 0.9 | V | |
| | | VDD VOUT1: IOUT1=1mA | - | - | 2.0 | V | |
| Oscillation Start Voltage 2 | VST2-1 | FB1=0V | - | - | 0.8 | V | |
| Maximum Duty Ratio 1 | MAXDTY1 | Same as IDD1 | 75 | 80 | 85 | % | |
| Minimum Duty Ratio 1 | MINDTY1 | Same as IDD2 | - | - | 0 | % | |
| PFM Duty Ratio 1 | PFMDTY1 | No Load, VPWM1=0V | 22 | 30 | 38 | % | |
| Efficiency 1 (*4) | EFFI1 | IOUT=130mA N-ch MOSFET: XP161A1355P | - | 83 | - | % | |
| Soft-Start Time 1 | TSS1 | VOUT1 x 0.95V, EN1=0V 0.65V | 5.0 | 10.0 | 20.0 | ms | |
| EXT1 "High" ON Resistance | REXTBH1 | FB1=0, EXT1=VDD-0.4V | - | 28 | 47 | | |
| EXT1 "Low" ON Resistance | REXTBL1 | EN1=FB2=0V, EXT1=0.4V | - | 22 | 30 | | |
| PWM1 "High" Voltage | VPWMH1 | No Load | 0.65 | - | - | V | |
| PWM1 "Low" Voltage | VPWML1 | No Load | - | - | 0.20 | V | |

Unless otherwise stated, VDD=EN1=PWM1=3.0V, EN2=PWM2=GND, EXT2=OPEN, FB2=OPEN, VIN=1.8V

Output 2 Characteristics: Step-Down Controller

Ta=25

| PARAMETER | SYMBOL | CONDITIONS | MIN. | TYP. | MAX. | UNITS | CIRCUIT |
|---------------------------|---------|---|-------|-------|-------|-------|---------|
| FB 2 Voltage | VFB2 | VIN=3.0V, IOUT2=10mA | 0.882 | 0.900 | 0.918 | V | |
| Minimum Operating Voltage | VINmin | | - | - | 2.0 | V | |
| Maximum Duty Ratio 2 | MAXDTY2 | Same as IDD1 | 100 | - | - | % | |
| Minimum Duty Ratio 2 | MINDTY2 | Same as IDD2 | - | - | 0 | % | |
| PFM Duty Ratio 2 | PFMDTY2 | No Load, VPWM2=0V | 22 | 30 | 38 | % | |
| Efficiency 2 (*4) | EFFI2 | IOUT2=250mA P-ch MOSFET: XP162A12A6P | - | 91 | - | % | |
| Soft-Start Time 2 | TSS2 | VOUT2 x 0.95V, EN2=0V 0.65V | 5.0 | 10.0 | 20.0 | ms | |
| EXT2 "High" ON Resistance | REXTBH2 | EN2=0, EXT2=VDD-0.4V | - | 28 | 47 | | |
| EXT2 "Low" ON Resistance | REXTBL2 | FB2=0V, EXT2=0.4V | - | 22 | 30 | | |
| PWM2 "High" Voltage | VPWMH2 | No Load | 0.65 | - | - | V | |
| PWM2 "Low" Voltage | VPWML2 | No Load | - | - | 0.20 | V | |

Unless otherwise stated, VDD=EN2=PWM2=3.0V, PWM1=EN1=GND, EXT1=OPEN, FB1=OPEN, VIN=5.0V

NOTE: *1 : Although the IC's step-up operations start from a VDD of 0.8V, the output voltage and switching frequency are stabilized at VDD 2.0V. Therefore, a VDD of more than 2.0V is recommended when VDD is supplied from VIN or other power sources.

*2 : Although the IC's switching operations start from a VIN of 0.9V, the IC's power supply pin (VDD) and output voltage monitor pin (FB1) should be connected to VOUT1. With operations from VIN=0.9V, the 2nd channel's (output 2) EN2 pin should be set to chip disable. Once output voltage VOUT1 is more than 2.0V, the EN2 pin should be set to chip enable.

*3 : Please be careful not to exceed the breakdown voltage level of the external components.

*4 : $EFFI = \left\{ \frac{(\text{output voltage}) \times (\text{output current})}{(\text{input voltage}) \times (\text{input current})} \right\} \times 100$

OPERATIONAL EXPLANATION

The XC9502 series are multi-functional, 2 channel step-up and down DC/DC converter controller ICs with built-in high speed, low ON resistance drivers.

<Error Amp. >

The error amplifier is designed to monitor the output voltage and it compares the feedback voltage (FB) with the reference voltage. In response to feedback of a voltage lower than the reference voltage, the output voltage of the error amp. decreases.

<OSC Generator>

This circuit generates the switching frequency, which in turn generates the reference clock.

<Ramp Wave Generator 1, 2>

The ramp wave generator generates a saw-tooth waveform based on outputs from the Phase Shift Generator.

<PWM Comparator 1, 2>

The PWM comparator compares outputs from the error amp. and saw-tooth waveform. When the voltage from the error amp's output is low, the external switch will be set to ON.

<PWM/PFM Controller 1, 2>

This circuit generates PFM pulses.

Control can be switched between PWM control and PWM/PFM automatic switching control using external signals.

The PWM/PFM automatic switching mode is selected when the voltage of the PWM1 (2) pin is less than 0.2V, and the control switches between PWM and PFM automatically depending on the load. As the PFM circuit generates pulses based on outputs from the PWM comparator, shifting between modes occurs smoothly. PWM control mode is selected when the voltage of the PWM1 (2) pin is more than 0.65V. Noise is easily reduced with PWM control since the switching frequency is fixed. Control suited to the application can easily be selected which is useful in audio applications, for example, where traditionally, efficiencies have been sacrificed during stand-by as a result of using PWM control (due to the noise problems associated with the PFM mode in stand-by).

<Vref with Soft Start 1, 2>

The reference voltage, Vref (FB pin voltage)=0.9V, is adjusted and fixed by laser trimming (for output voltage settings, please refer to the notes on next page). To protect against inrush current, when the power is switched on, and also to protect against voltage overshoot, soft-start time is set internally to 10ms. It should be noted, however, that this circuit does not protect the load capacitor (CL) from inrush current. With the Vref voltage limited and depending upon the input to the error amps, the operation maintains a balance between the two inputs of the error amps and controls the EXT pin's ON time so that it doesn't increase more than is necessary.

<Chip Enable Function>

This function controls the operation and shutdown of the IC. When the voltage of the EN1 or EN2 pins is 0.2V or less, the mode will be chip disable, the channel's operations will stop and the EXT1 pin will be kept at a low level (the external N-ch MOSFET will be OFF) and the EXT2 pin will be kept at a high level (the external P-type MOSFET will be OFF). When both EN1 and EN2 are in a state of chip disable, current consumption will be no more than 3.0 μ A.

When the EN1 or EN2 pin's voltage is 0.65V or more, the mode will be chip enable and operations will recommence. With soft-start, 95% of the set output voltage will be reached within 10mS (TYP.) from the moment of chip enable.

Although IC starts oscillation from a VIN of 0.9V, the IC's power supply pin (VDD) and the output voltage monitor pin (FB1) should be connected to VOUT1. The start-up sequence for EN1 and EN2 is required when operations begin with a power supply voltage of VDD=0.9V, and channel two's (output 2) EN2 pin should be set to chip disable and turn it to enable when VOUT1 is more than 2.0V. For power supply voltages of VDD<2.0V, oscillation may occur irrespective of the FB pin voltage. Should this happen, you may find that output voltage will be higher than the set voltage. The FB pin voltage and the reference voltage Vref will be compared and output voltage will be controlled when the power supply voltage is VDD>2.0V or more. With power supply voltages of VDD>2.0V, the start-up sequence for EN1 and EN2 will not be required.

OPERATIONAL EXPLANATION (Continued)

<Setting of Output Voltage>

Output voltage can be set by adding external split resistors. Output voltage is determined by the following equation, based on the values of RFB11 (RFB21) and RFB12 (RFB22). The sum of RFB11 (RFB21) and RFB12 (RFB22) should normally be 1M or less.

$$V_{OUT} = 0.9 \times (R_{FB11} + R_{FB12}) / R_{FB12}$$

The value of CFB1 (CFB2), speed-up capacitor for phase compensation, should be $f_{zfb} = 1 / (2 \times C_{FB1} \times R_{FB11})$ which is equal to 12kHz. Adjustments are required from 1kHz to 50kHz depending on the application, value of inductance (L), and value of load capacity (CL).

[Example of Calculation]

When $R_{FB11} = 200k$ and $R_{FB12} = 75k$, $V_{OUT1} = 0.9 \times (200k + 75k) / 75k = 3.3V$.

[Typical Example]

| V _{OUT} (V) | R _{FB11} (k) | R _{FB12} (k) | C _{FB1} (pF) | V _{OUT} (V) | R _{FB11} (k) | R _{FB12} (k) | C _{FB1} (pF) | V _{OUT} (V) | R _{FB11} (k) | R _{FB12} (k) | C _{FB1} (pF) |
|-------------------------|---------------------------|---------------------------|--------------------------|-------------------------|---------------------------|---------------------------|--------------------------|-------------------------|---------------------------|---------------------------|--------------------------|
| 1.0 | 30 | 270 | 430 | 2.5 | 390 | 220 | 33 | 8.0 | 120 | 15 | 100 |
| 1.5 | 220 | 330 | 62 | 2.7 | 360 | 180 | 33 | 12.0 | 160 | 13 | 82 |
| 1.8 | 220 | 220 | 62 | 3.0 | 560 | 240 | 24 | - | - | - | - |
| 2.0 | 330 | 270 | 39 | 3.3 | 200 | 75 | 62 | - | - | - | - |
| 2.2 | 390 | 270 | 33 | 5.0 | 82 | 18 | 160 | - | - | - | - |

The same method can be also adopted for channel two (output 2).

[External Components]

Output 1 (Step-Up DC/DC controller)

Tr 1 : * MOSFET

XP161A1355PR (N-ch Power MOSFET, TOREX)

Note: V_{GS} Breakdown Voltage of this Tr. is 8V so please be careful with the power supply voltage. For 6V power supply voltage, XP161A1265PR which V_{GS} breakdown voltage is 12V is recommended. V_{ST1} of XP161A1355PR is 1.2V (MAX.) and that of XP161A1265PR is 1.5V (MAX.)

SD 1: MA2Q737 (Schottky, MATSUSHITA)
CMS02 (Schottky, TOSHIBA)

L 1: 10 μH (CDRH5D28, SUMIDA, FOSC = 500kHz)
15 μH (CDRH5D28, SUMIDA, FOSC = 300kHz)
22 μH (CDRH5D28, SUMIDA, FOSC = 180kHz)

CL1 : 16V, 47 μF (Tantalum)
Increase capacity according to the equation below when the step-up voltage ratio is large and output current is high.

$$C = (CL \text{ standard value}) \times (I_{OUT1}(\text{mA}) / 300\text{mA}) \times V_{OUT1} / V_{IN}$$

Tr : * NPN MOSFET 2SD1628 (SANYO)

RB1 : 500 (Adjust in accordance with load & Tr.'s HFE.)
Set according to the equation below:

$$R_{B1} = (V_{IN} - 0.7) \times hFE / IC - R_{EXTBH}$$

CB1 : 2200pF (Ceramic)

Set according to the equation below:

$$C_{B1} = (2 \times R_{B2} \times FOSC \times 0.7)$$

Output 2 (Step-Down DC/DC controller)

Tr 2 : * MOSFET

XP162A12A6P (P-ch Power MOSFET, TOREX)

Note: V_{GS} Breakdown Voltage of this Tr. is 12V so please be careful with the power supply voltage.

SD 2: MA2Q737 (Schottky, MATSUSHITA)
CMS02 (Schottky, TOSHIBA)

L 2: 10 μH (CDRH5D28, SUMIDA, FOSC = 500kHz)
22 μH (CDRH5D28, SUMIDA, FOSC = 300kHz)
47 μH (CDRH5D28, SUMIDA, FOSC = 180kHz)

CL1 : 16V, 47 μF (Tantalum)
Increase capacity according to the equation below when the step-up voltage ratio is large and output current is high.

$$C = (CL \text{ standard value}) \times (I_{OUT2}(\text{mA}) / 500\text{mA}) \times V_{OUT2} / V_{IN}$$

Tr : * PNP MOSFET 2SA1213 (SANYO)

RB1 : 500 (Adjust in accordance with load & Tr.'s HFE.)
Set according to the equation below:

$$R_{B2} = (V_{IN} - 0.7) \times hFE / IC - R_{EXTBH}$$

CB1 : 2200pF (Ceramic)

Set according to the equation below:

$$C_{B2} = (2 \times R_{B2} \times FOSC \times 0.7)$$

TEST CIRCUITS

Circuit

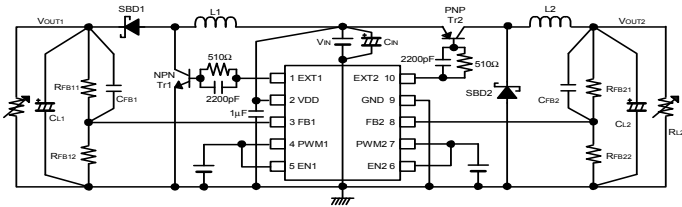

Circuit

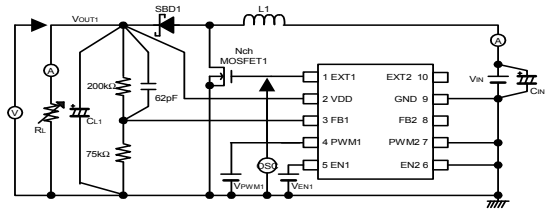

Circuit

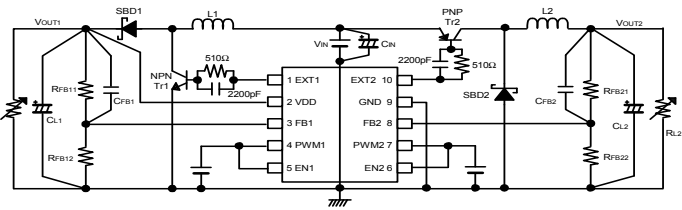

Circuit

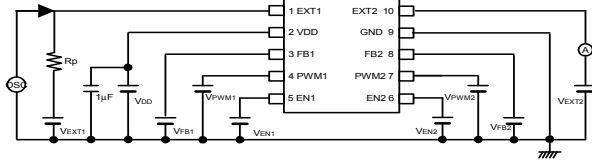

Circuit

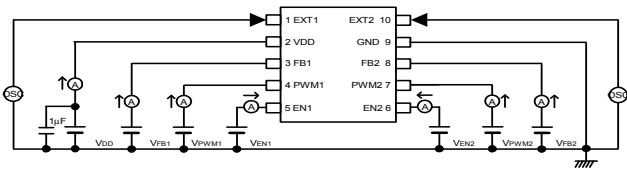

Circuit

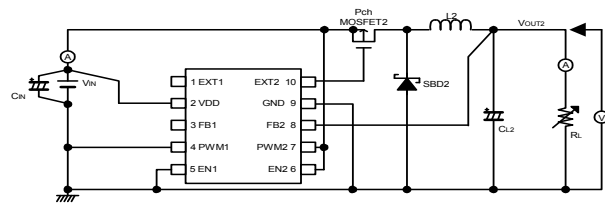

Circuit

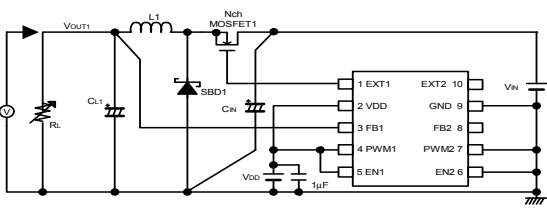

Circuit

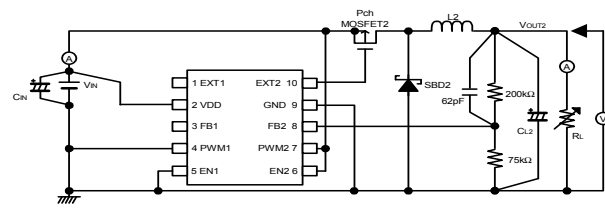

EXTERNAL COMPONENTS USED FOR TEST CIRCUITS

| | | | |
|---------|---|--|---------------|
| Circuit | L1, L2: | 22 μ H (CDRH5D28, SUMIDA) | : XC9502B092A |
| | | 15 μ H (CDRH5D28, SUMIDA) | : XC9502B093A |
| | | 10 μ H (CDRH5D28, SUMIDA) | : XC9502B095A |
| | SD1, SD2: | CRS02 (Schottky diode, TOSHIBA) | |
| | | EC10QS06 (Schottky diode, NIHON INTER) | |
| | CL1, CL2: | 16MCE476MD2 (Tantalum, NIHON CHEMICON) | |
| | | 35MCE335MB2 x 3 (Tantalum, NIHON CHEMICON) | |
| | CIN: | 16MCE476MD2 (Tantalum, NIHON CHEMICON) | |
| | NPN Tr1: | 2SD1628 (SANYO) | |
| | PNP Tr1: | 2SA1213 (TOSHIBA) | |
| | RFB: | Please use by the conditions as below: | |
| | $R_{FB11} + R_{FB12} \leq 1M$ | | |
| | $R_{FB21} + R_{FB22} \leq 1M$ | | |
| | $R_{FB11} / R_{FB12} = (\text{Setting output voltage} / 0.9) - 1$ | | |
| | $V_{OUT2} = (0.9 - V_{OUT1}) \times (R_{FB21}/R_{FB22}) + 0.9V$ | | |
| CFB: | Please adjust as below: | | |
| | $f_{xib} = 1/(2 \times \pi \times C_{FB1} \times R_{FB11}) = 1kHz \sim 50kHz$ (12kHz usual) | | |
| | $f_{xib} = 1/(2 \times \pi \times C_{FB2} \times R_{FB21}) = 1kHz \sim 50kHz$ (12kHz usual) | | |
| Circuit | L1: | 22 μ H (CDRH5D28, SUMIDA) | |
| | SD1: | MA2Q737 (Schottky diode, MATSUSHITA) | |
| | CL1: | 16MCE476MD2 (Tantalum, NIHON CHEMICON) | |
| | CIN: | 16MCE476MD2 (Tantalum, NIHON CHEMICON) | |
| | N-ch MOSFET1: | XP161A1355P (TOREX) | |
| Circuit | L1: | 22 μ H (CDRH5D28, SUMIDA) | : XC9502B092A |
| | | 15 μ H (CDRH5D28, SUMIDA) | : XC9502B093A |
| | | 10 μ H (CDRH5D28, SUMIDA) | : XC9502B095A |
| | SD1: | MA2Q737 (Schottky diode, MATSUSHITA) | |
| | CL1: | 16MCE476MD2 (Tantalum, NIHON CHEMICON) | |
| | CIN: | 16MCE476MD2 (Tantalum, NIHON CHEMICON) | |
| | N-ch MOSFET1: | XP161A1355P (TOREX) | |
| Circuit | L1: | 22 μ H (CDRH5D28, SUMIDA) | |
| | SD1: | MA2Q737 (Schottky diode, MATSUSHITA) | |
| | CL1: | 16MCE476MD2 (Tantalum, NIHON CHEMICON) | |
| | CIN: | 16MCE476MD2 (Tantalum, NIHON CHEMICON) | |
| | P-ch MOSFET2: | XP162A12A6P (TOREX) | |
| Circuit | L2: | 22 μ H (CDRH5D28, SUMIDA) | : XC9502B092A |
| | | 15 μ H (CDRH5D28, SUMIDA) | : XC9502B093A |
| | | 10 μ H (CDRH5D28, SUMIDA) | : XC9502B095A |
| | SD2: | MA2Q737 (Schottky diode, MATSUSHITA) | |
| | CL2: | 16MCE476MD2 (Tantalum, NIHON CHEMICON) | |
| | CIN: | 16MCE476MD2 (Tantalum, NIHON CHEMICON) | |
| | P-ch MOSFET2: | XP162A12A6P (TOREX) | |

NOTES ON USE

1. Checking for Intermittent Oscillation

The XC9502 series is subject to intermittent oscillation in the proximity of the maximum duty if the step-down ratio is low (e.g., from 4.2 V to 3.3 V) or a heavy load is applied where the duty ratio becomes high. Check waveforms at EXT under your operating conditions. A remedy for this problem is to raise the inductance of coil L or increase the load capacitance C_L .

2. PWM/PFM Automatic Switching

If PWM/PFM automatic switching control is selected and the step-up ratio is low (e.g., from 4.5V to 5.0V) or the step-down ratio is high (e.g., from 10.0V to 1.0 V), the control mode remains in PFM setting in the whole load range, since the duty ratio under continuous-duty condition is smaller than the PFM duty ratio of the XC9502 series. The output voltage's ripple voltage becomes substantially high under heavy load conditions, with the XC9502 series appearing to be producing an abnormal oscillation. If this operation becomes a concern, set pins PWM1 and PWM2 to High to set the control mode to PWM setting. For use under the above-mentioned condition, measured data of PWM/PFM automatic switching control shown on the data sheets are available up to $I_{OUT} = 100$ mA.

3. Ratings

Use the XC9502 series and external components within the limits of their ratings.

TYPICAL PERFORMANCE CHARACTERISTICS

< 1ch Step-Up DC/DC Controller >

(1) Output Voltage vs. Output Current

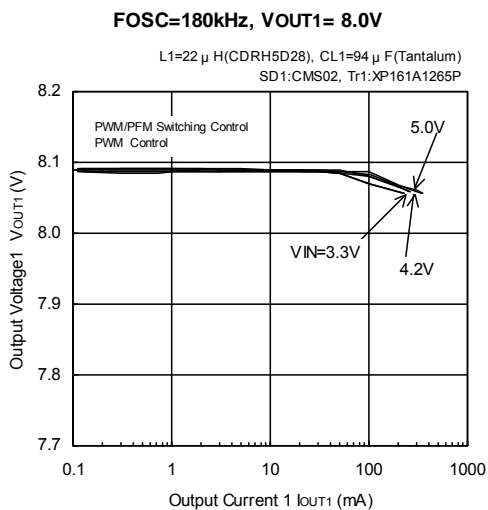
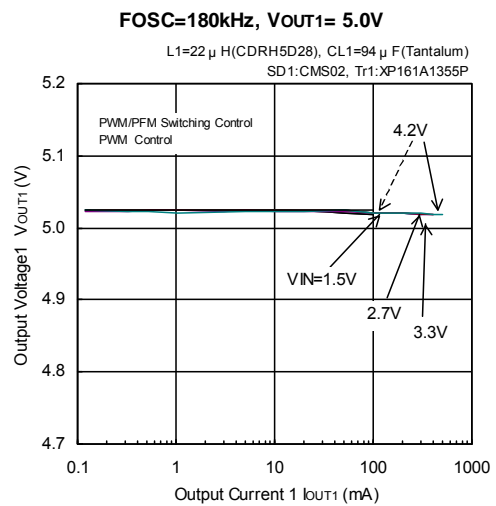
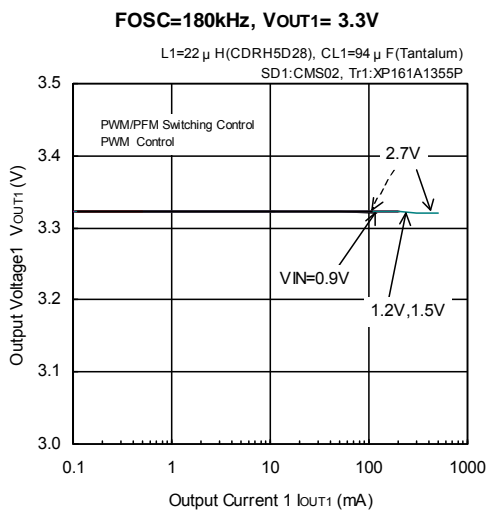
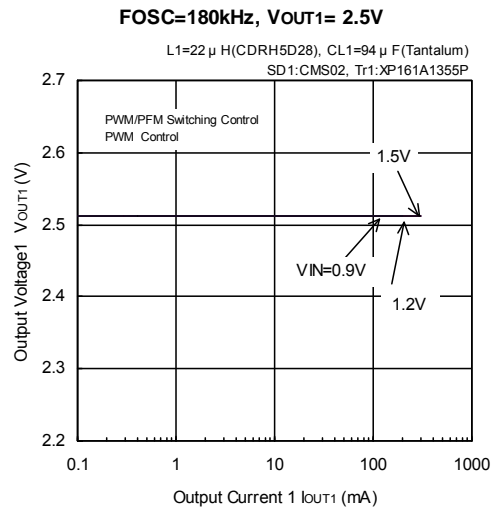
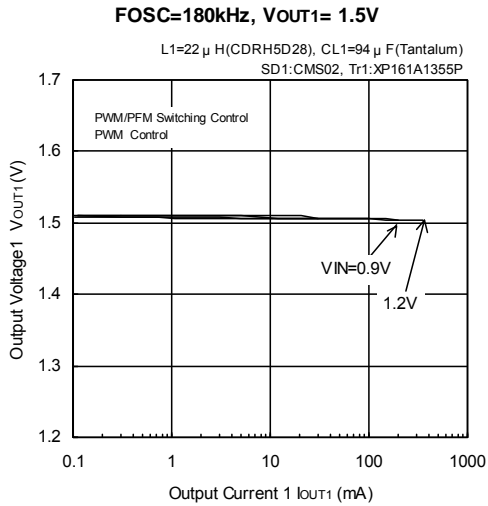

Dotted Arrowhead -----> PWM/PFM Switching Control

TYPICAL PERFORMANCE CHARACTERISTICS (Continued)

< 1ch Step-Up DC/DC Controller >

(1) Output Voltage vs. Output Current (Continued)

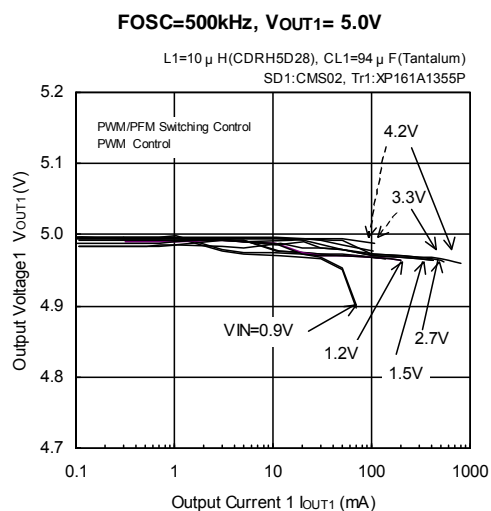
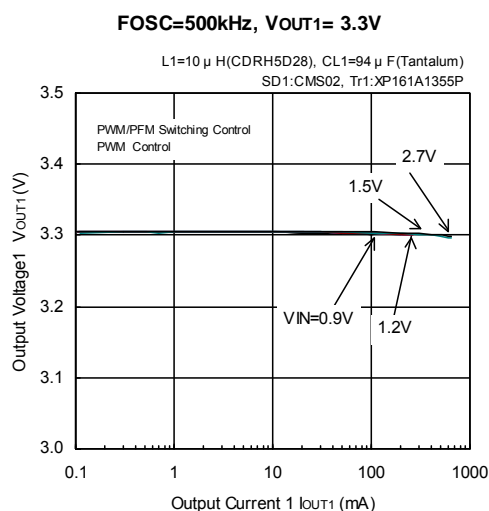
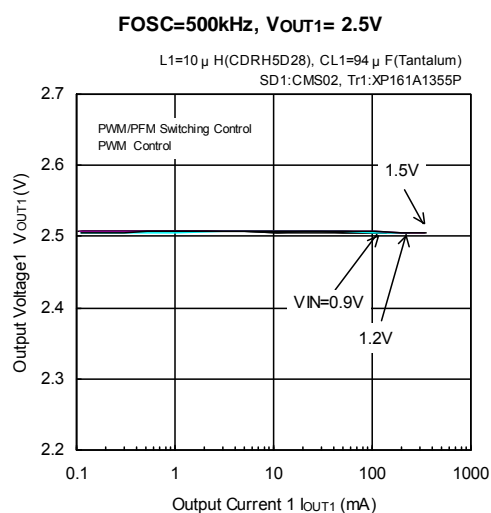
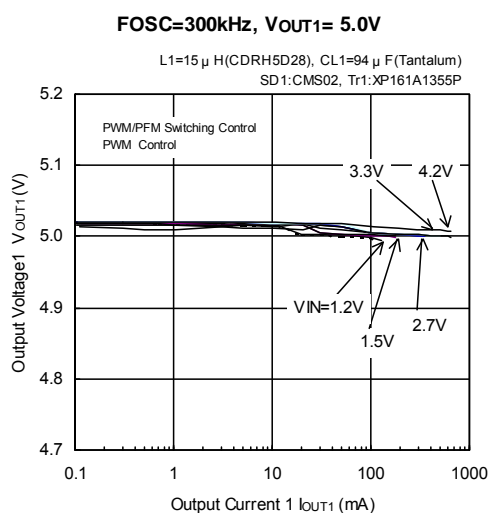
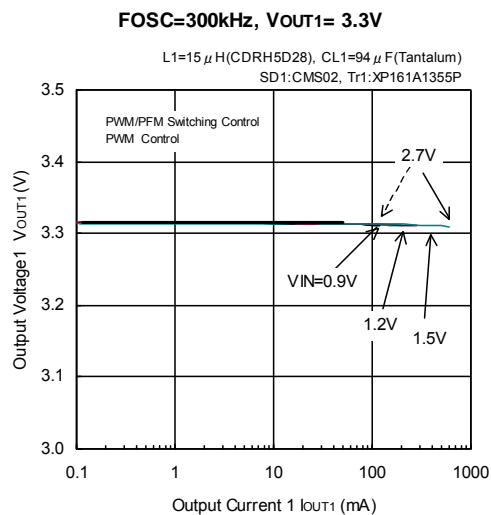
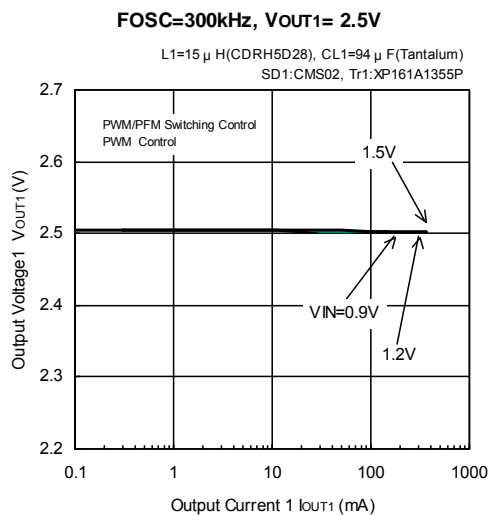

Dotted Arrowhead -----> PWM/PFM Switching Control

TYPICAL PERFORMANCE CHARACTERISTICS (Continued)

< 1ch Step-Up DC/DC Controller >

(2) Efficiency vs. Output Current

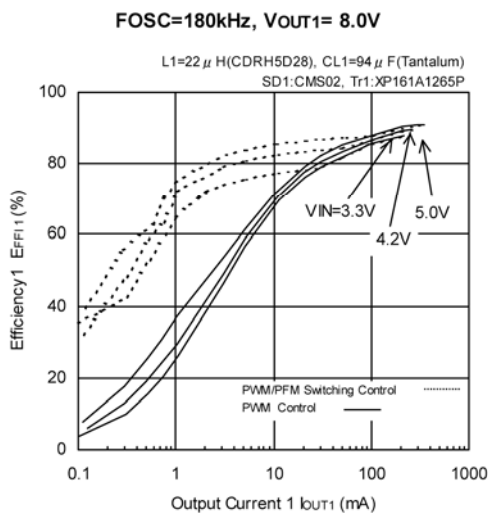
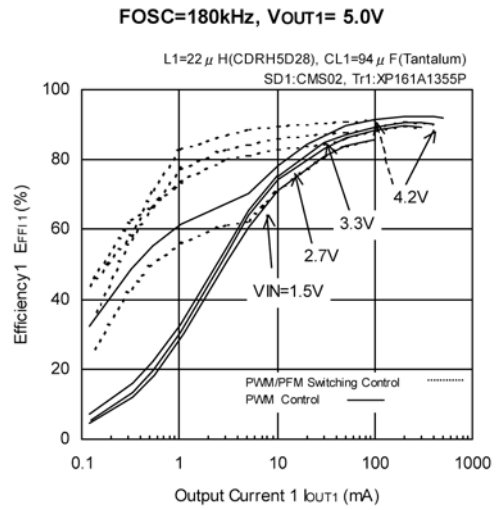
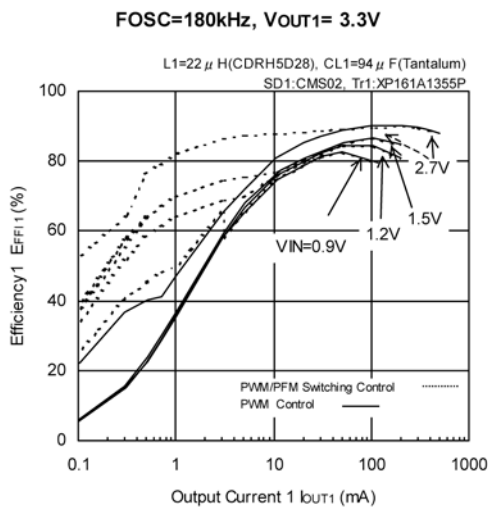
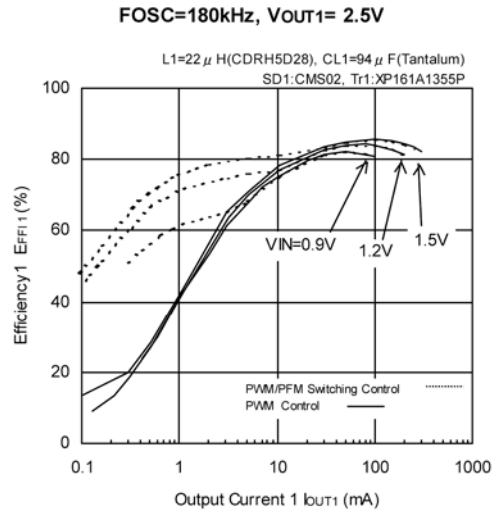
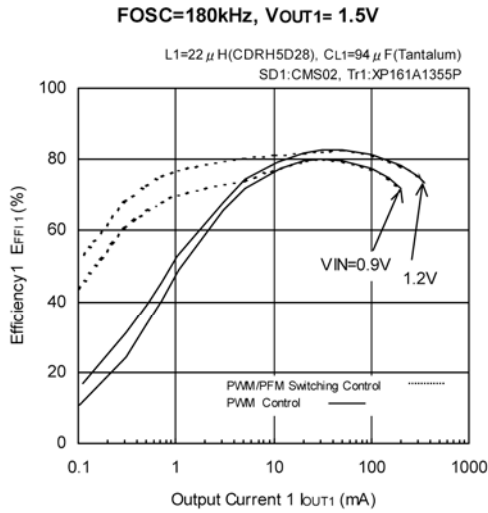

Dotted Arrowhead ----> PWM/PFM Switching Control

TYPICAL PERFORMANCE CHARACTERISTICS (Continued)

< 1ch Step-Up DC/DC Controller >

(2) Efficiency vs. Output Current (Continued)

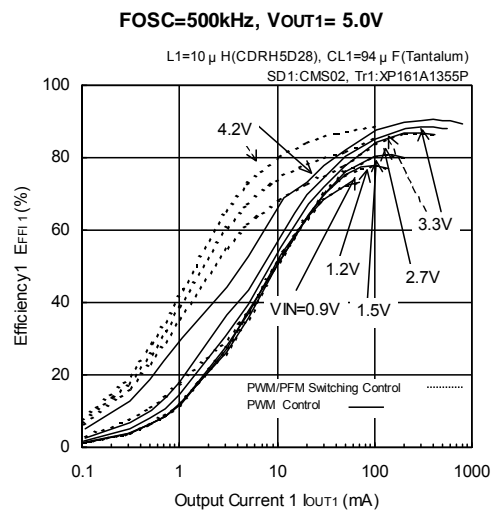
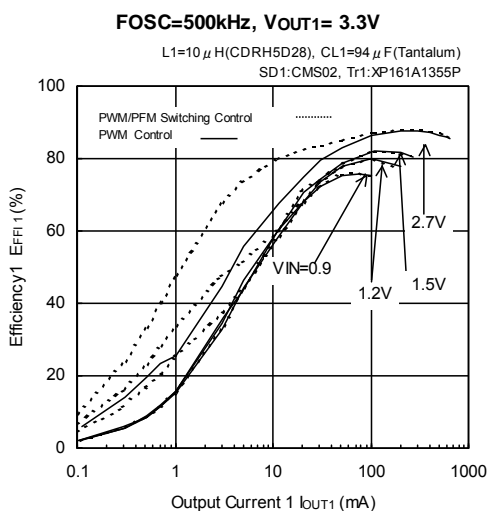
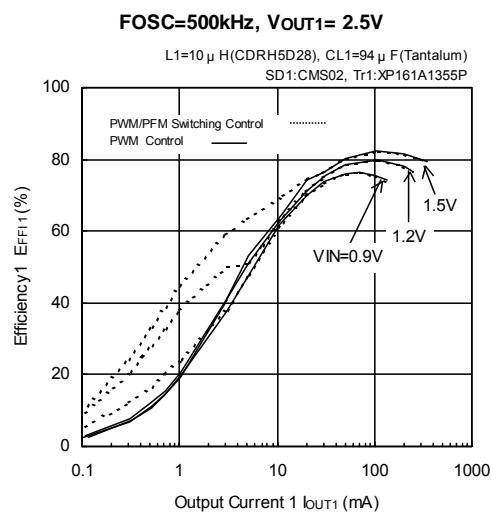
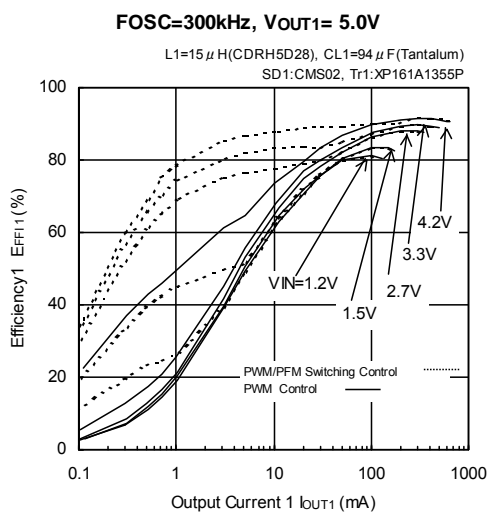
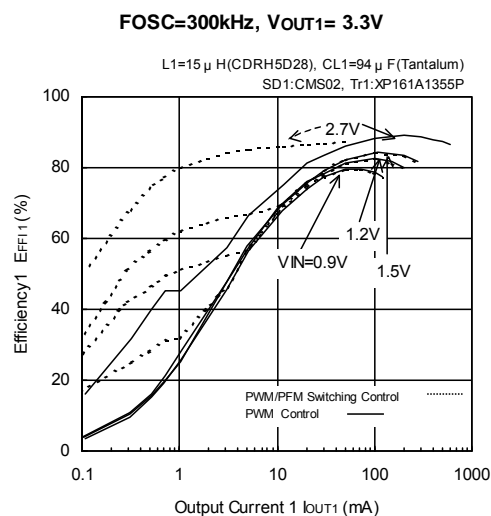
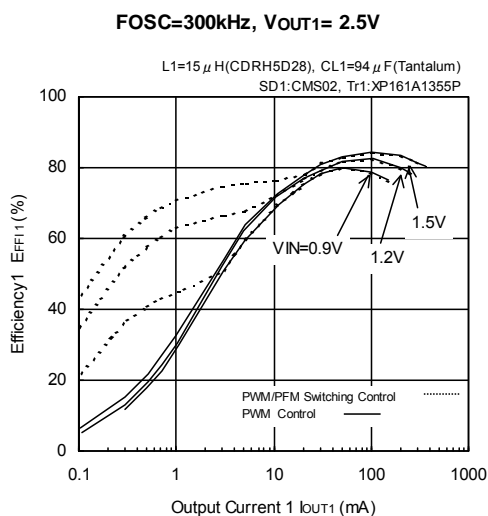

Dotted Arrowhead -----> PWM/PFM Switching Control

TYPICAL PERFORMANCE CHARACTERISTICS (Continued)

< 1ch Step-Up DC/DC Controller >

(3) Ripple Voltage vs. Output Current

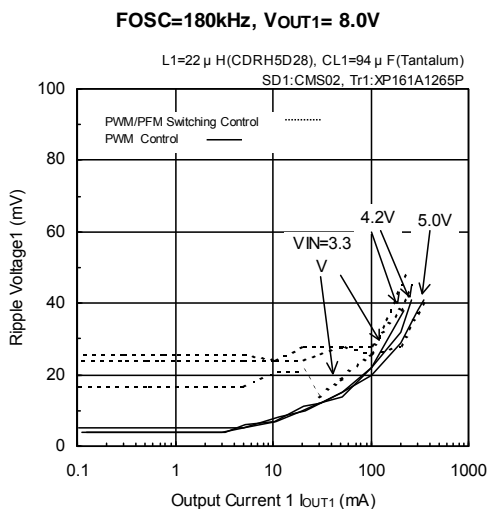
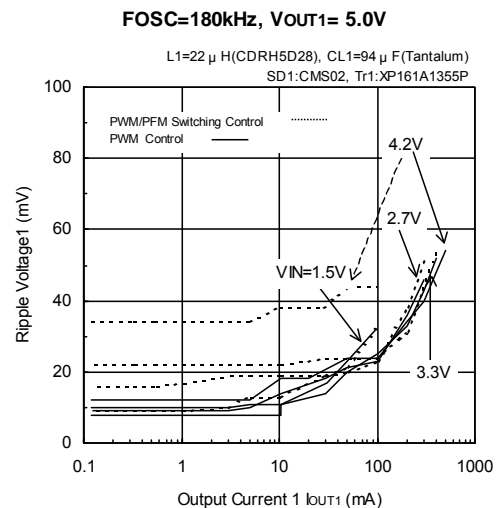
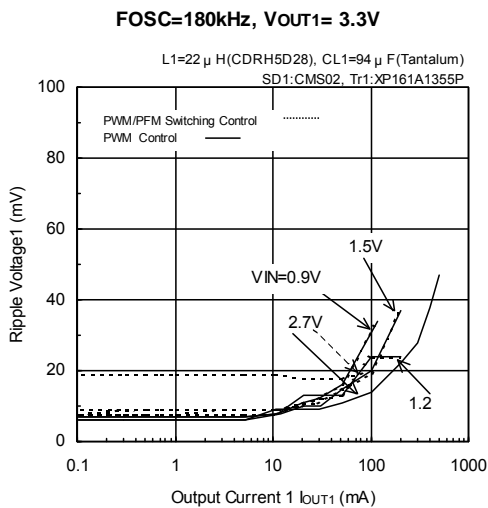
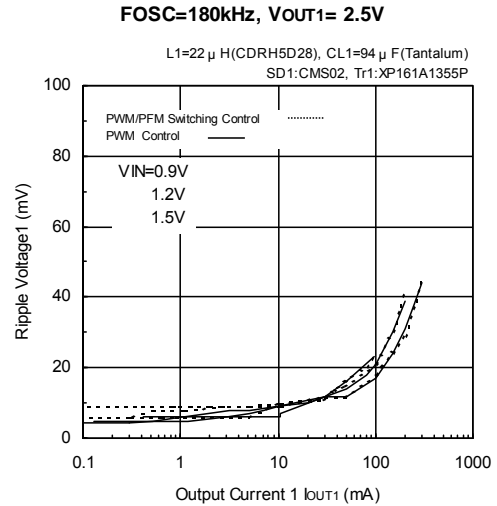
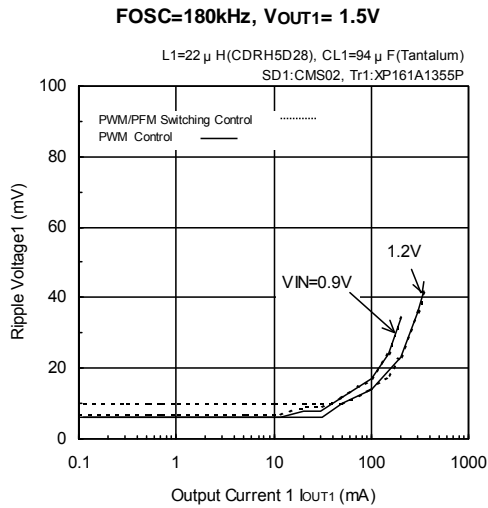

Dotted Arrowhead -----> PWM/PFM Switching Control

TYPICAL PERFORMANCE CHARACTERISTICS (Continued)

< 1ch Step-Up DC/DC Controller >

(3) Ripple Voltage vs. Output Current (Continued)

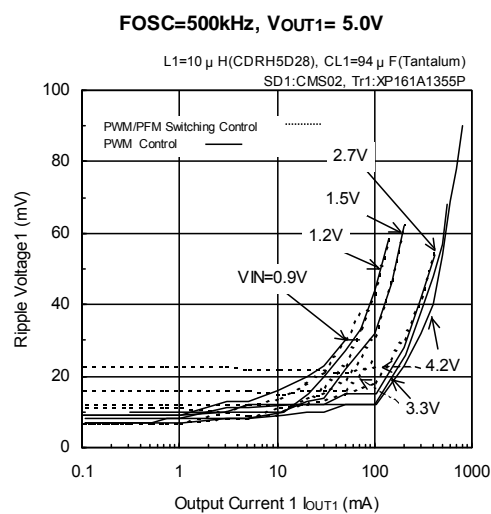
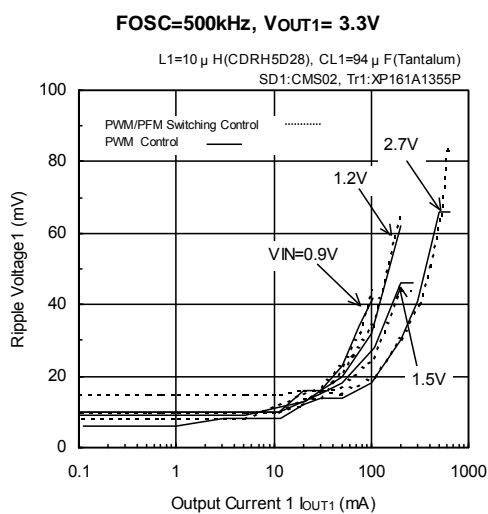
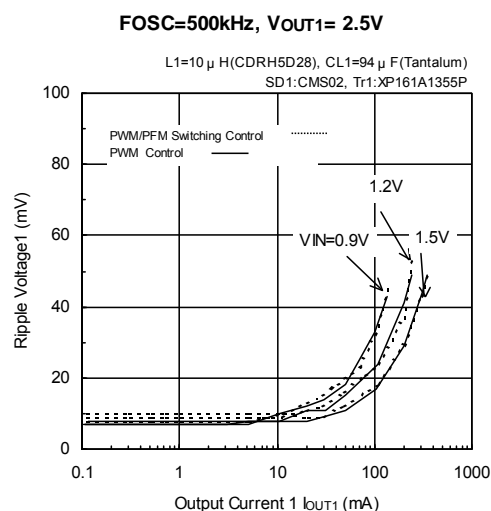
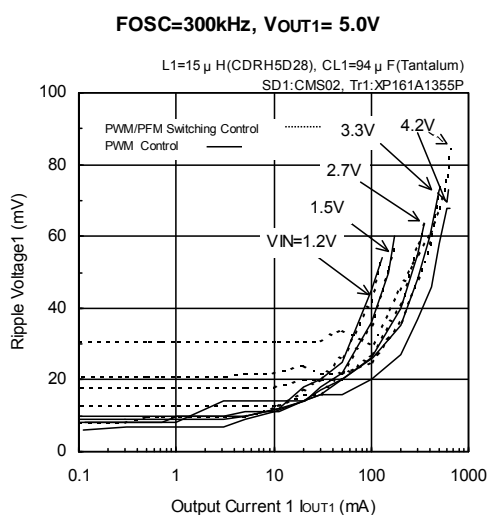
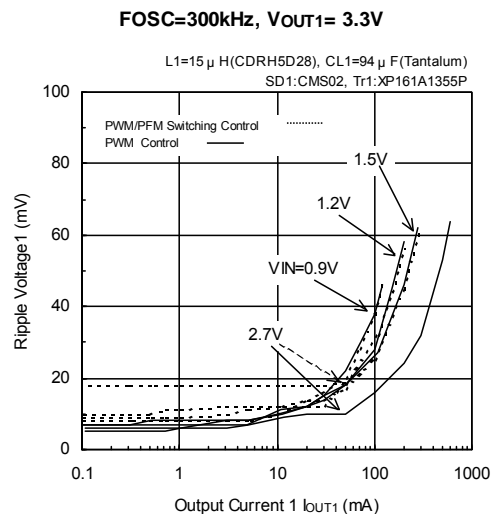
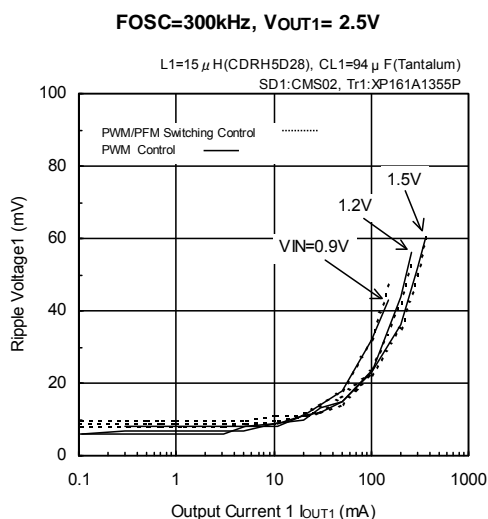

Dotted Arrowhead -----> PWM/PFM Switching Control

TYPICAL PERFORMANCE CHARACTERISTICS (Continued)

< 2ch Step-Down DC/DC Controller >

(4) Output Voltage vs. Output Current

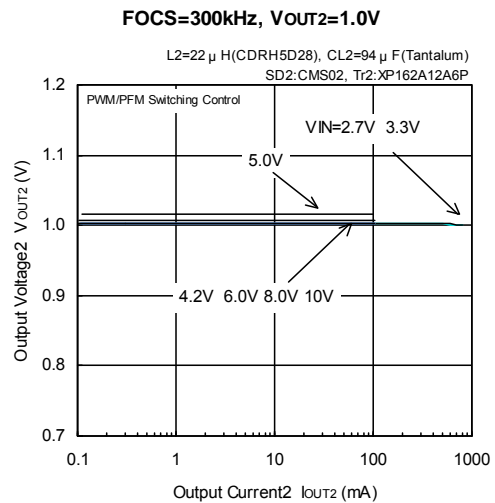
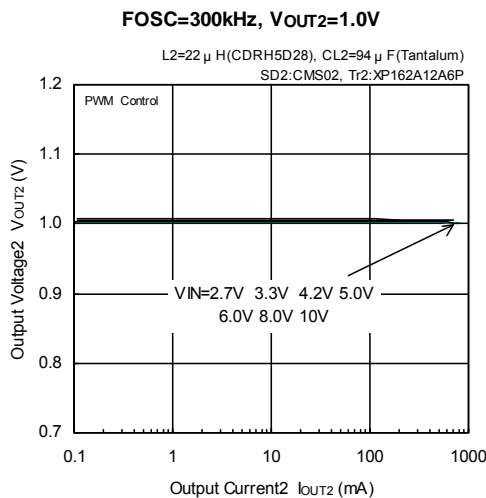
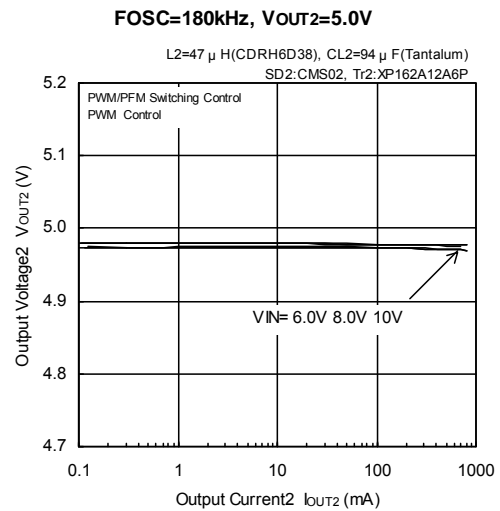
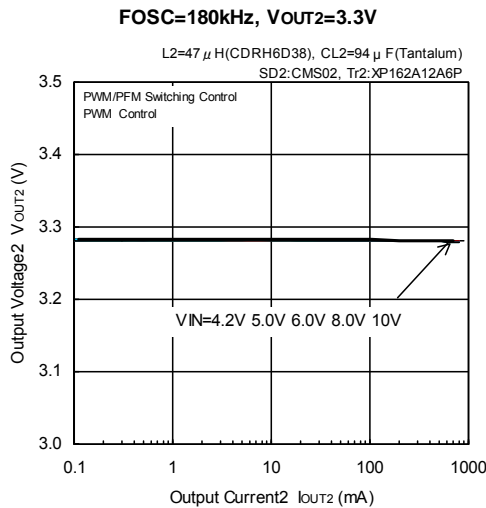
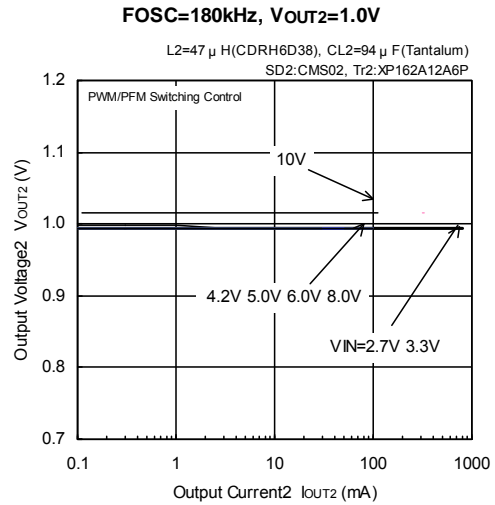
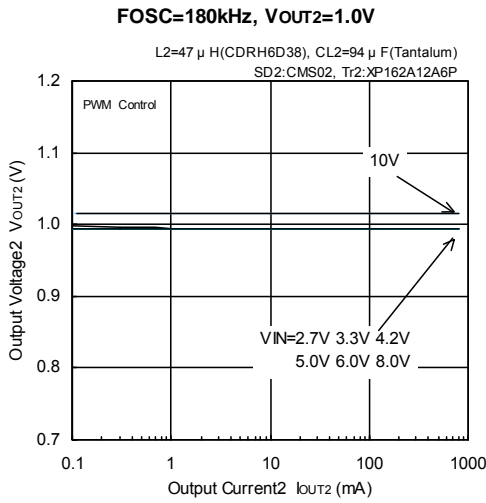

* When setting V_{OUT} = 1.0V, V_{IN} = 8.0V, 10.0V
CL should be 94 μ F (Tantalum) + 100 μ F (OS capacitor)

TYPICAL PERFORMANCE CHARACTERISTICS (Continued)

< 2ch Step-Down DC/DC Controller >

(4) Output Voltage vs. Output Current (Continued)

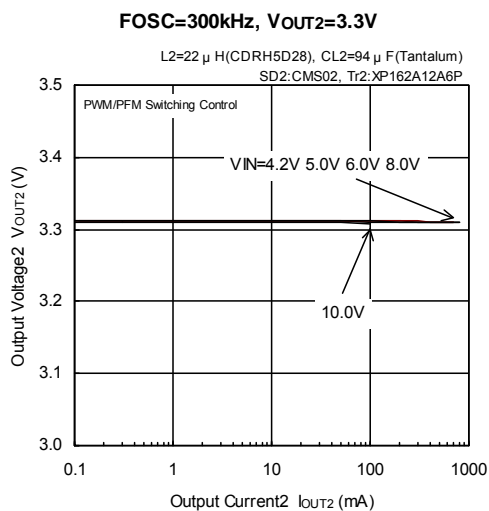
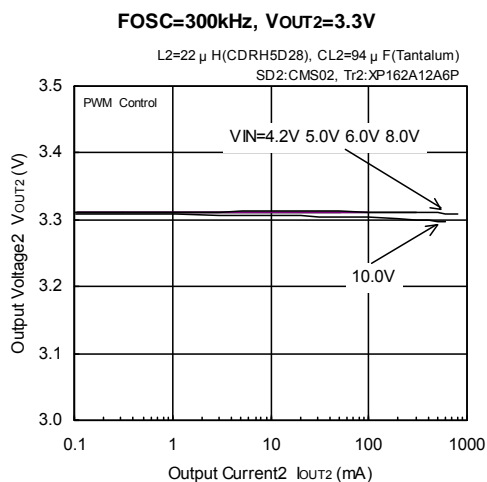
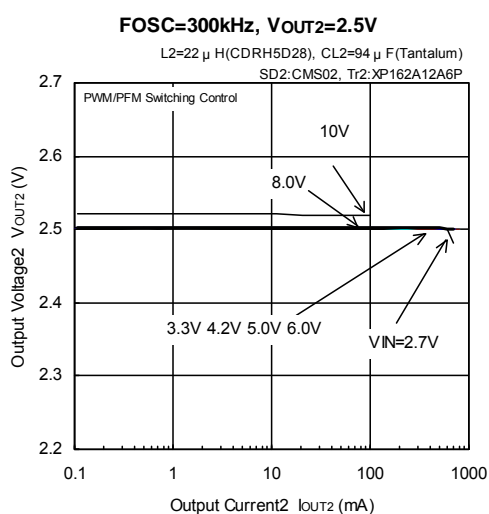
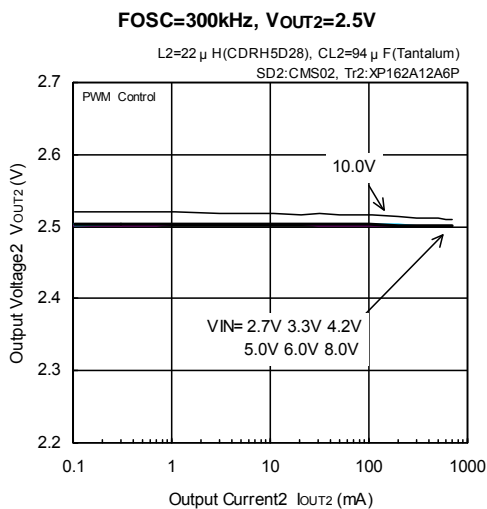
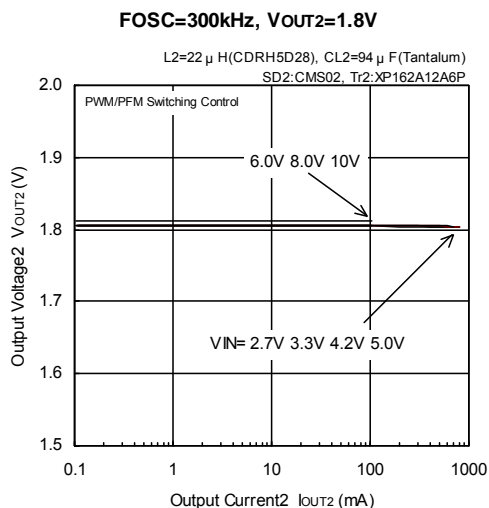
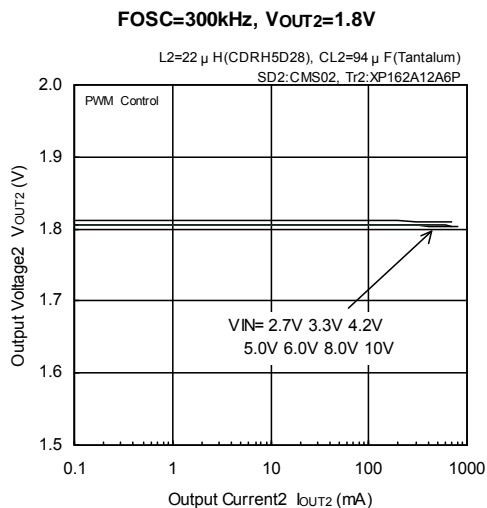

TYPICAL PERFORMANCE CHARACTERISTICS (Continued)

< 2ch Step-Down DC/DC Controller >

(4) Output Voltage vs. Output Current (Continued)

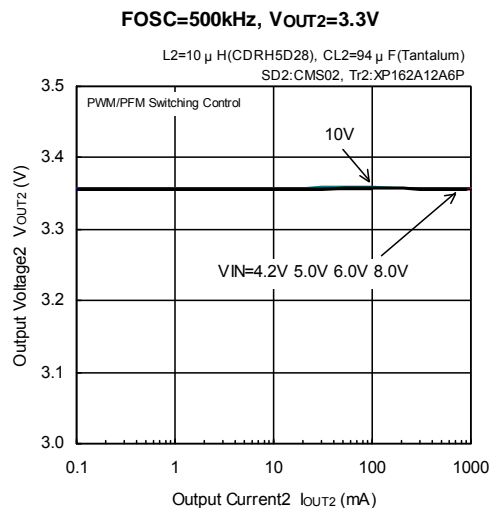
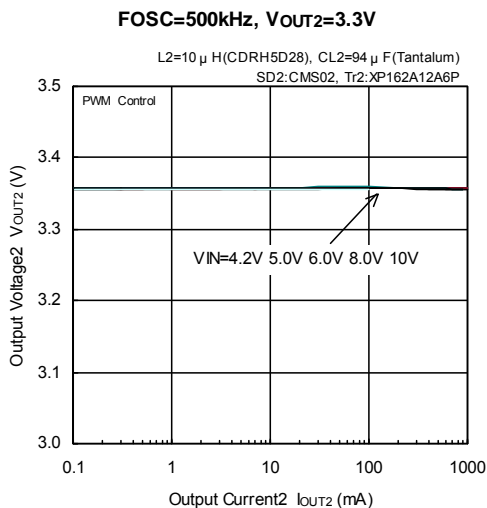
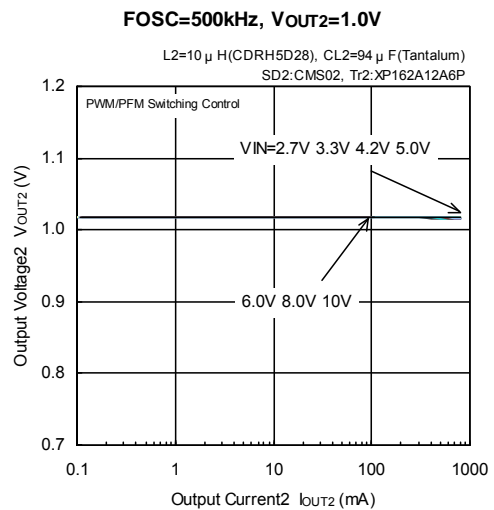
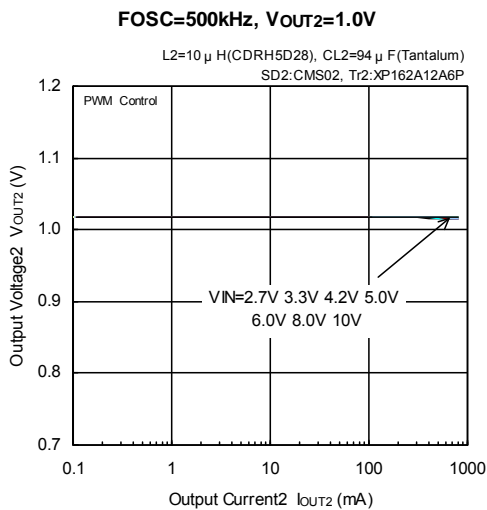
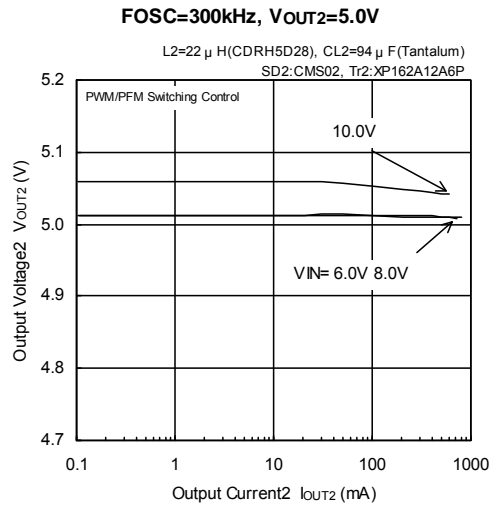
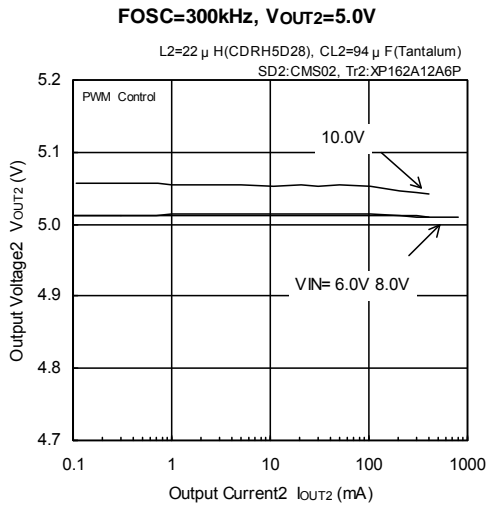

*When setting V_{OUT} = 1.0V, V_{IN} = 8.0V, 10.0V
CL should be 94 μ F (Tantalum) + 100 μ F (OS capacitor)

TYPICAL PERFORMANCE CHARACTERISTICS (Continued)

< 2ch Step-Down DC/DC Controller >

(4) Output Voltage vs. Output Current (Continued)

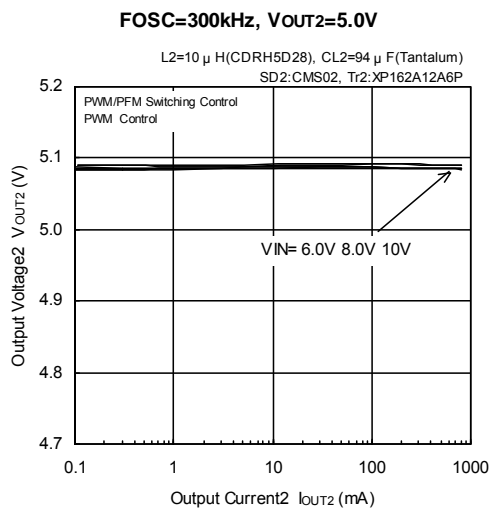

*When setting V_{OUT} = 1.0V, V_{IN} = 8.0V, 10.0V
 CL should be 94 μ F (Tantalum) + 100 μ F (OS capacitor)

TYPICAL PERFORMANCE CHARACTERISTICS (Continued)

< 2ch Step-Down DC/DC Controller >

(5) Efficiency vs. Output Current

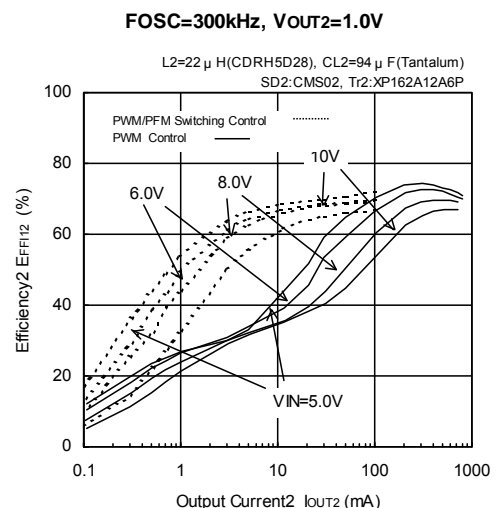
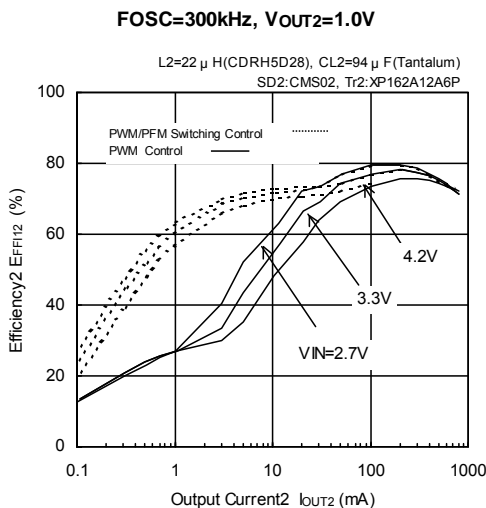
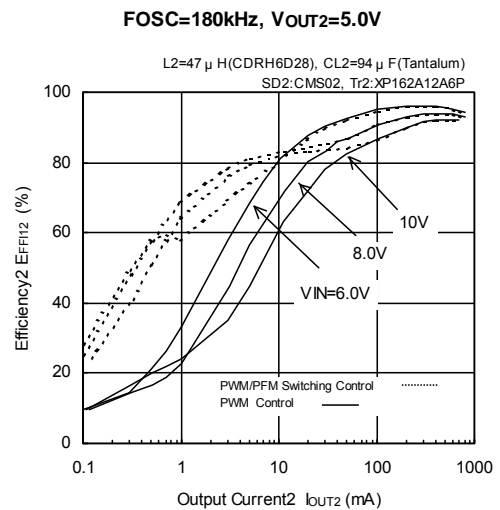
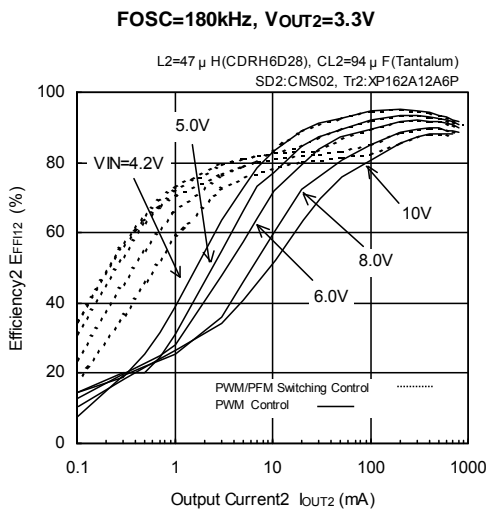
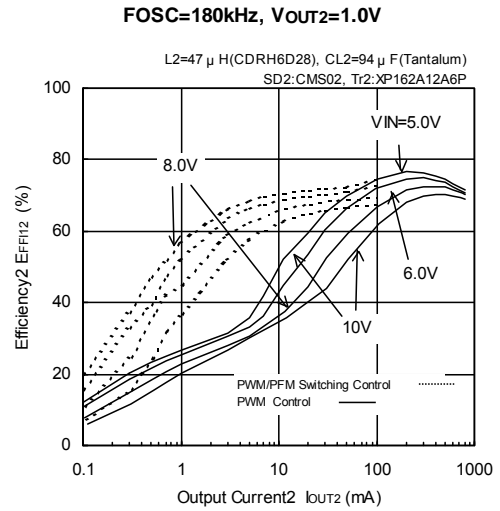
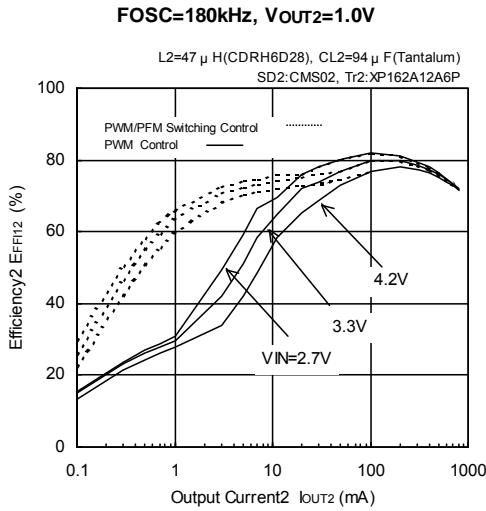

*When setting VOUT = 1.0V, VIN = 8.0V, 10.0V

CL should be 94 μ F (Tantalum) + 100 μ F (OS capacitor)

TYPICAL PERFORMANCE CHARACTERISTICS (Continued)

< 2ch Step-Down DC/DC Controller >

(5) Efficiency vs. Output Current (Continued)

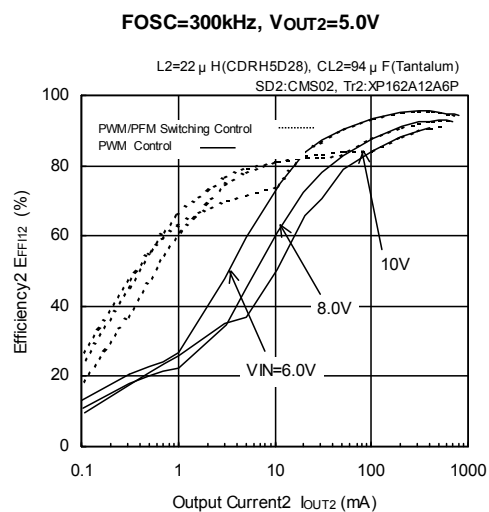
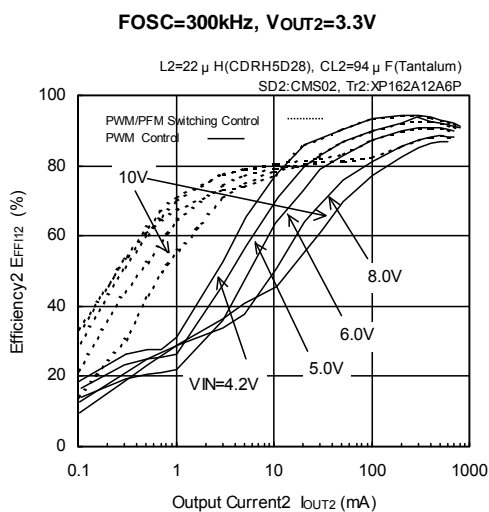
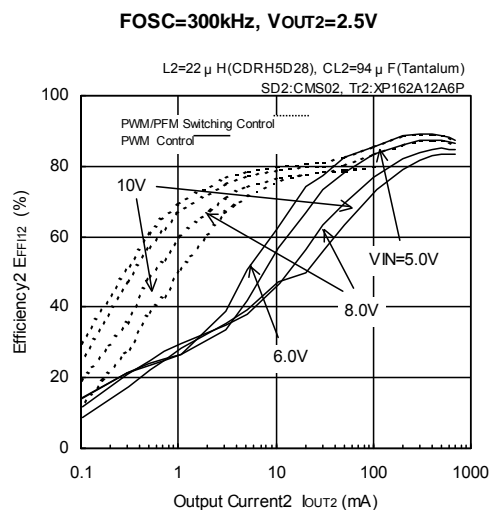
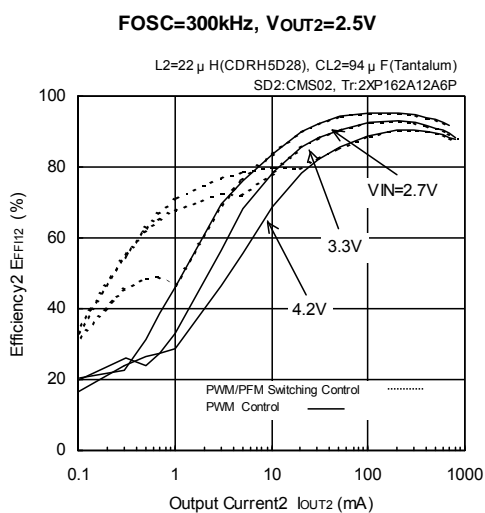
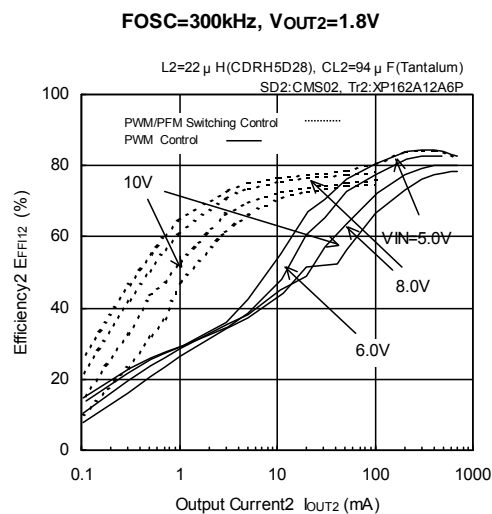
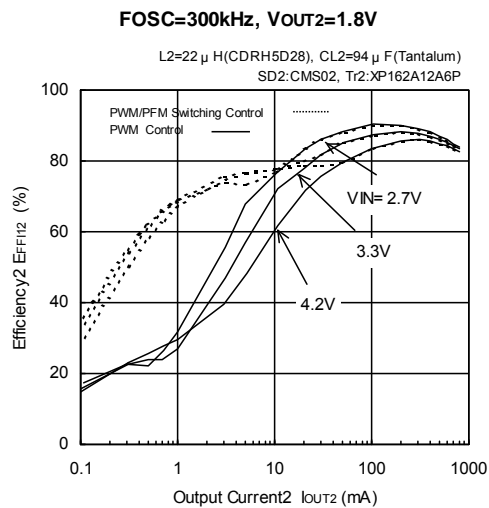

*When setting V_{OUT} = 1.0V, V_{IN} = 8.0V, 10.0V
CL should be 94 μ F (Tantalum) + 100 μ F (OS capacitor)

TYPICAL PERFORMANCE CHARACTERISTICS (Continued)

< 2ch Step-Down DC/DC Controller >

(5) Efficiency vs. Output Current (Continued)

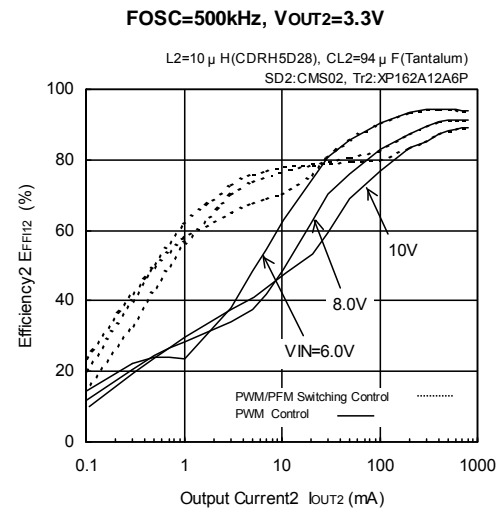
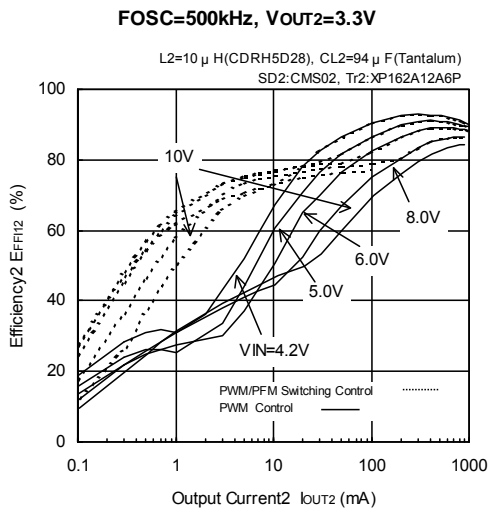
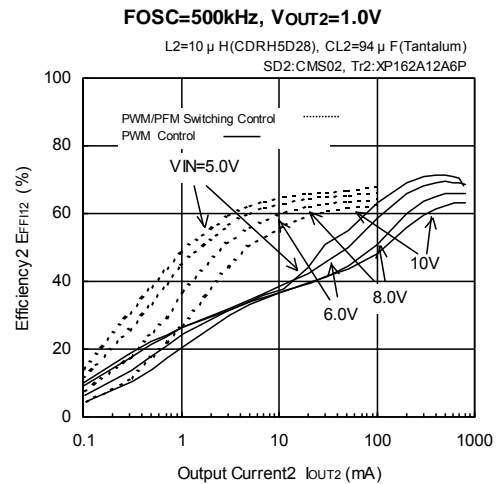
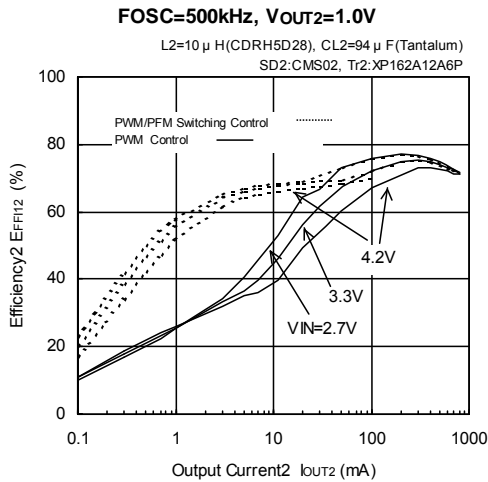

*When setting VOUT = 1.0V, VIN = 8.0V, 10.0V
 CL should be 94 μ F (Tantalum) + 100 μ F (OS capacitor)

TYPICAL PERFORMANCE CHARACTERISTICS (Continued)

< 2ch Step-Down DC/DC Controller >

(6) Ripple Voltage vs. Output Current

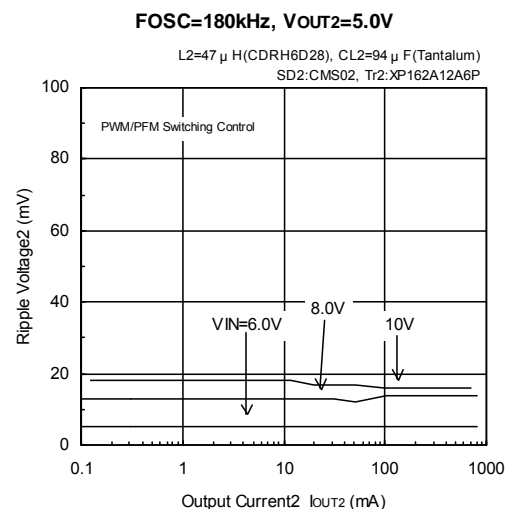
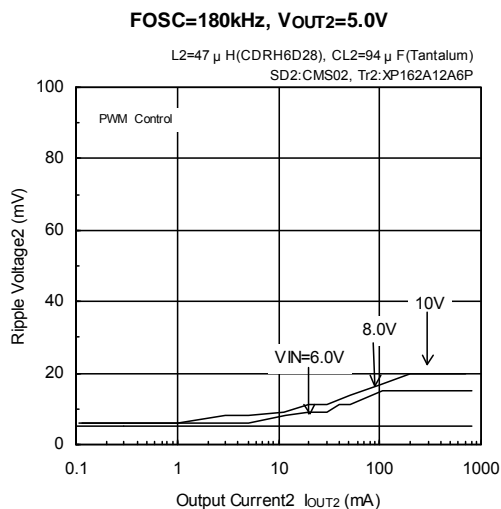
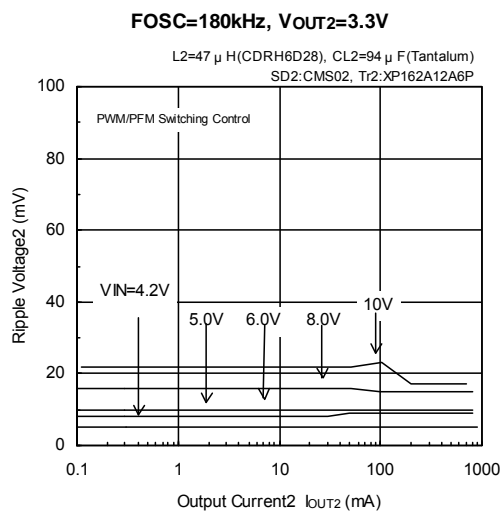
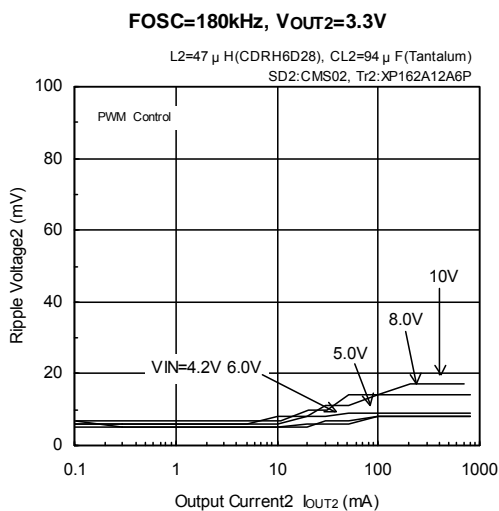
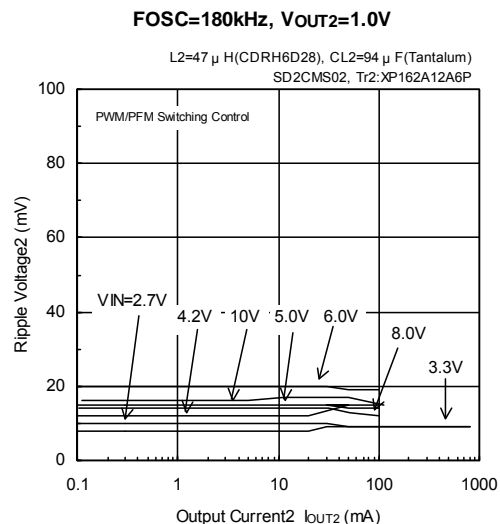
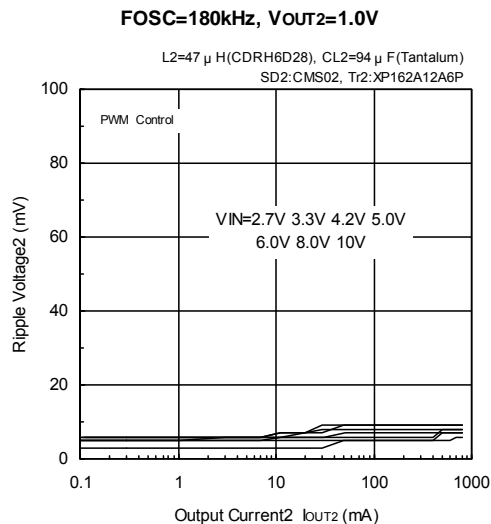

* When setting VOUT = 1.0V, VIN = 8.0V, 10.0V
CL should be 94 μ F (Tantalum) + 100 μ F (OS capacitor)

TYPICAL PERFORMANCE CHARACTERISTICS (Continued)

< 2ch Step-Down DC/DC Controller >

(6) Ripple Voltage vs. Output Current (Continued)

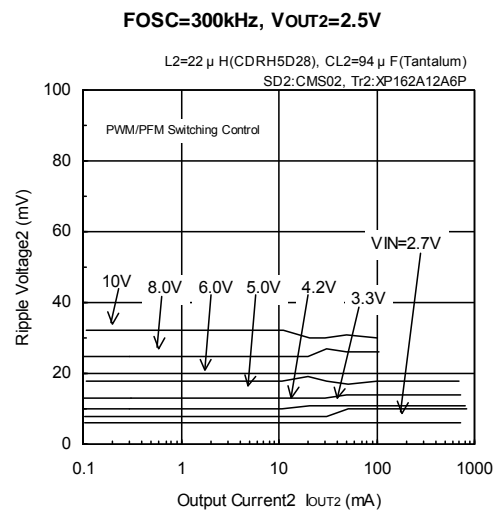
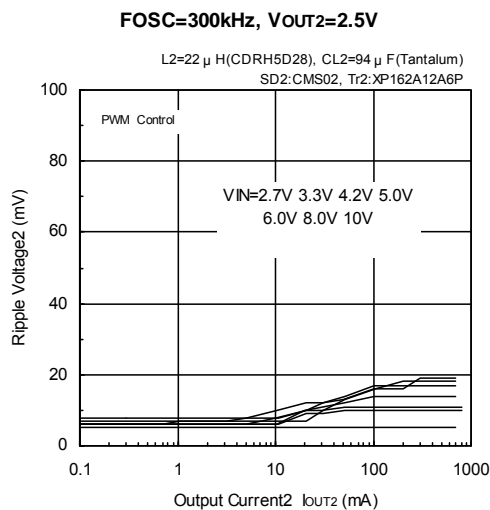
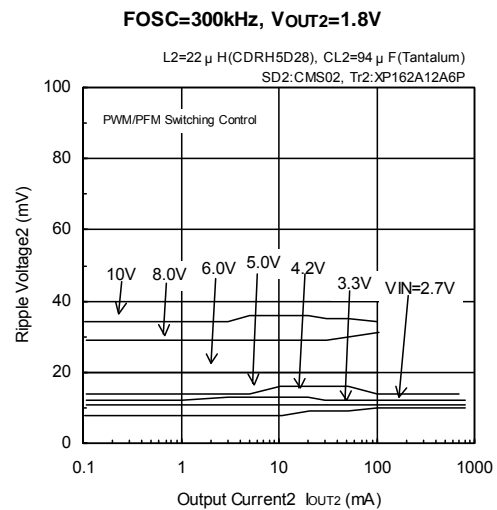
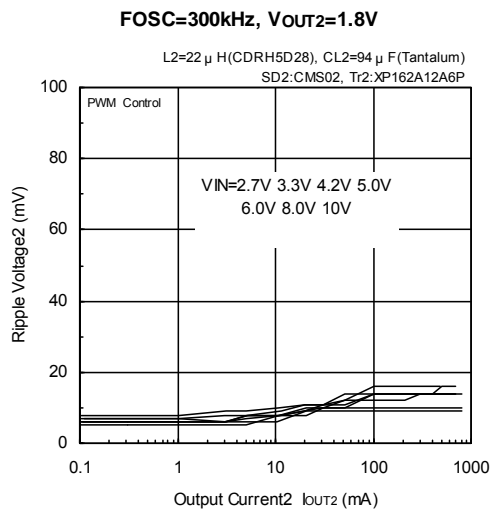
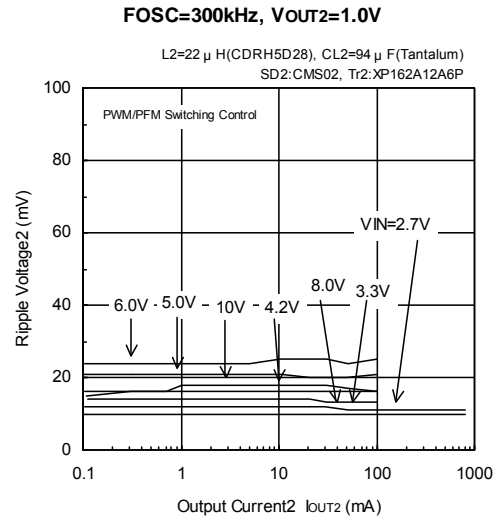
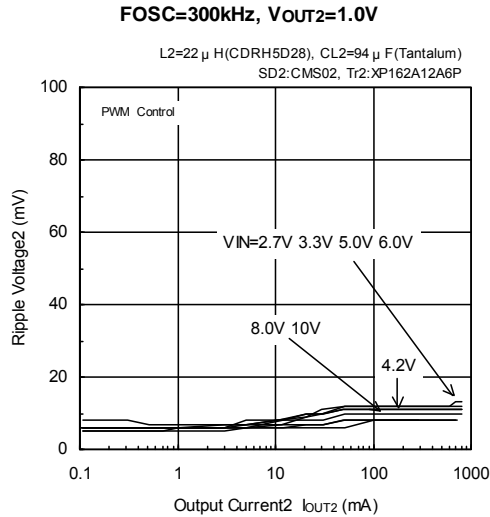

*When setting VOUT = 1.0V, VIN = 8.0V, 10.0V
CL should be 94 μ F (Tantalum) + 100 μ F (OS capacitor)

TYPICAL PERFORMANCE CHARACTERISTICS (Continued)

< 2ch Step-Down DC/DC Controller >

(6) Ripple Voltage vs. Output Current (Continued)

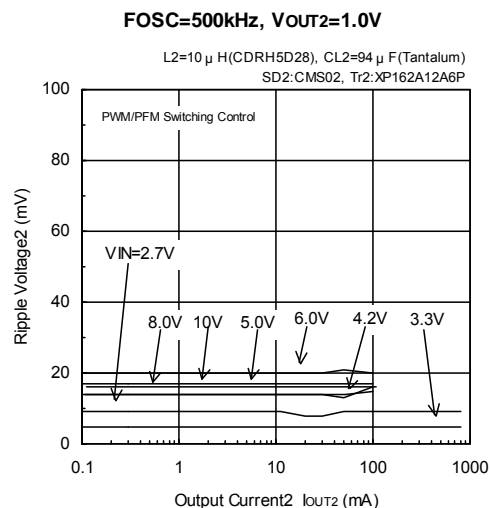
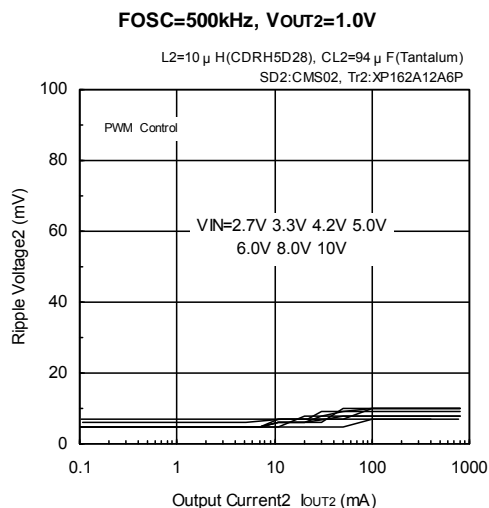
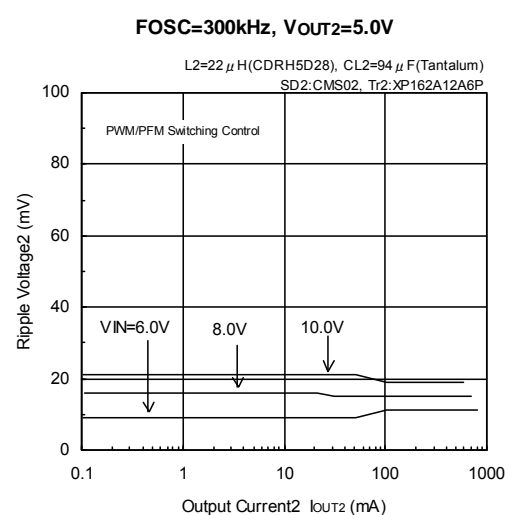
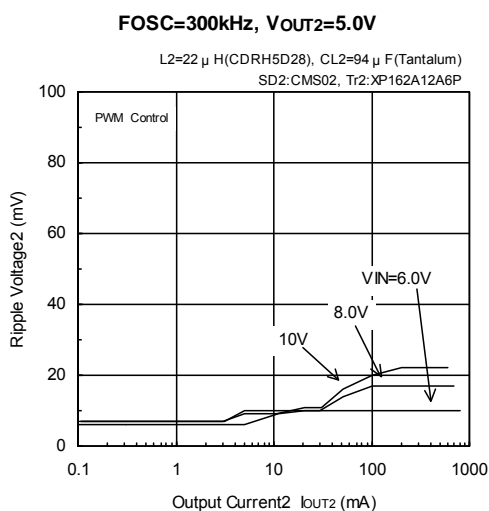
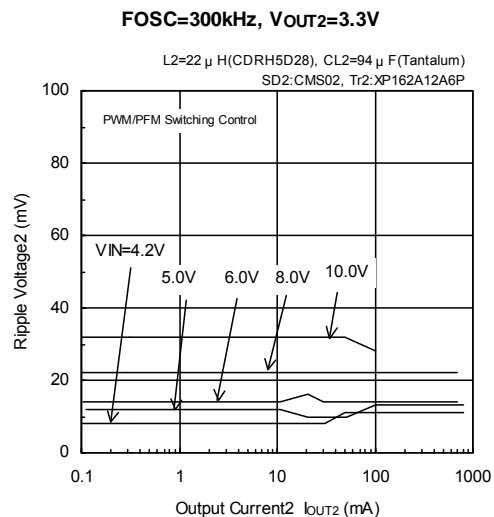
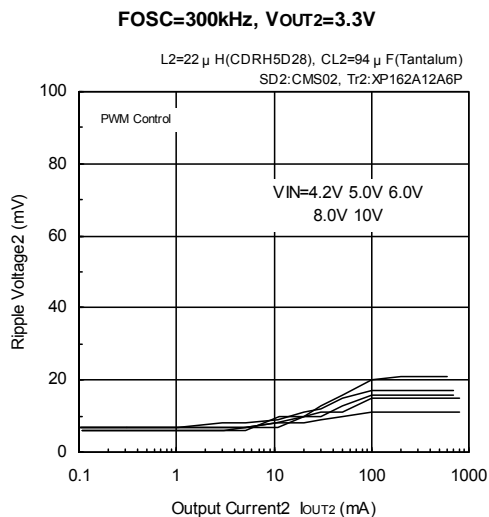

* When setting VOUT = 1.0V, VIN = 8.0V, 10.0V
CL should be 94 μ F (Tantalum) + 100 μ F (OS capacitor)

TYPICAL PERFORMANCE CHARACTERISTICS (Continued)

< 2ch Step-Down DC/DC Controller >

(6) Ripple Voltage vs. Output Current (Continued)

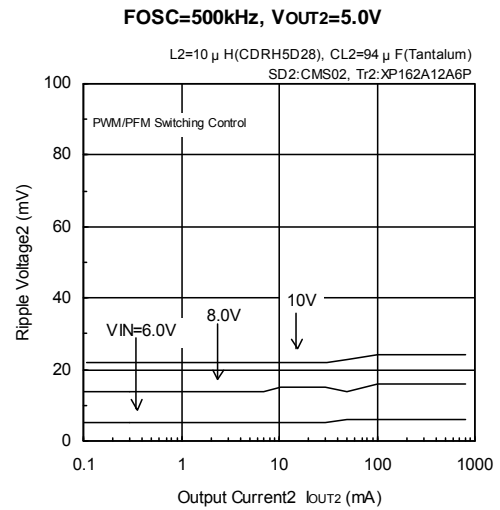
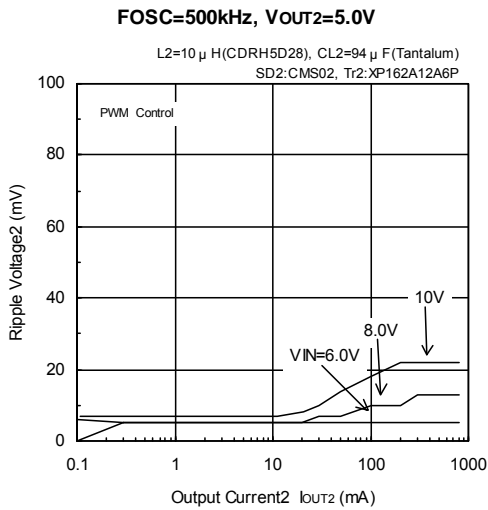
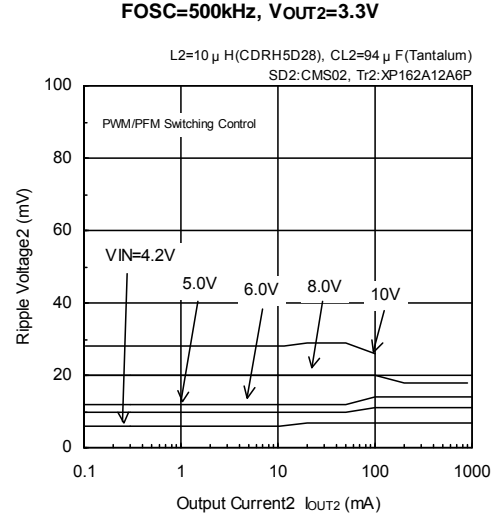
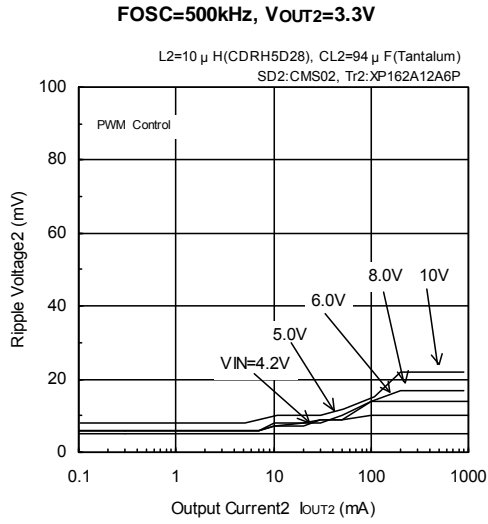

* When setting VOUT = 1.0V, VIN = 8.0V, 10.0V
CL should be 94 μ F (Tantalum) + 100 μ F (OS capacitor)

TYPICAL PERFORMANCE CHARACTERISTICS (Continued)

(7) Supply Current vs. Supply Voltage
XC9502B092 (180kHz)

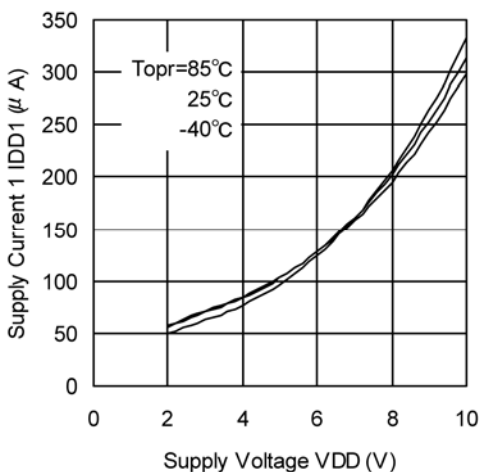

(8) Supply Current 1-1 vs. Supply Voltage
XC9502B092 (180kHz)

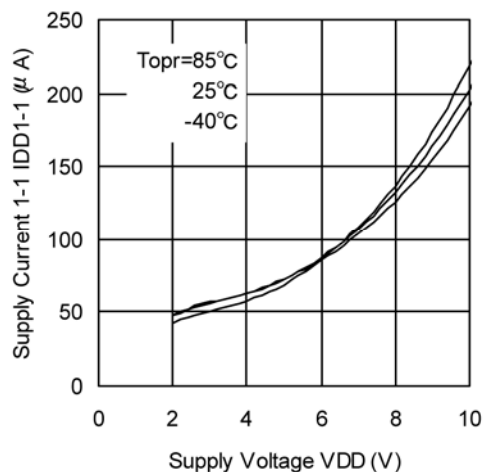

(9) Supply Current 1-2 vs. Supply Voltage
XC9502B092 (180kHz)

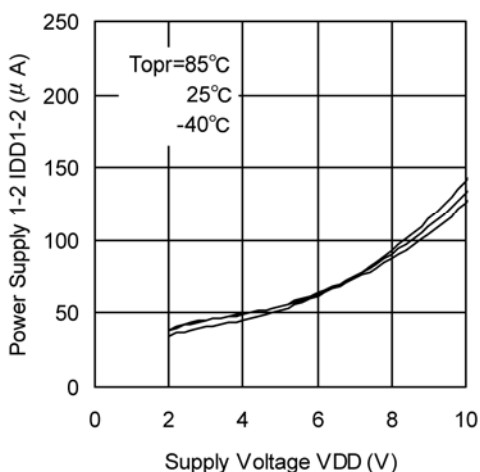

(10) Supply Current 1-3 vs. Supply Voltage
XC9502B092 (180kHz)

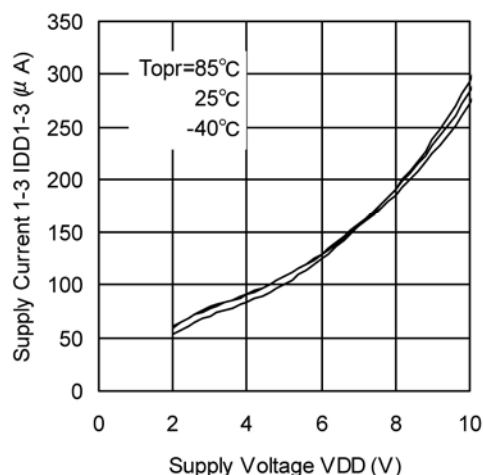

(11) Supply Current 1-4 vs. Supply Voltage
XC9502B092 (180kHz)

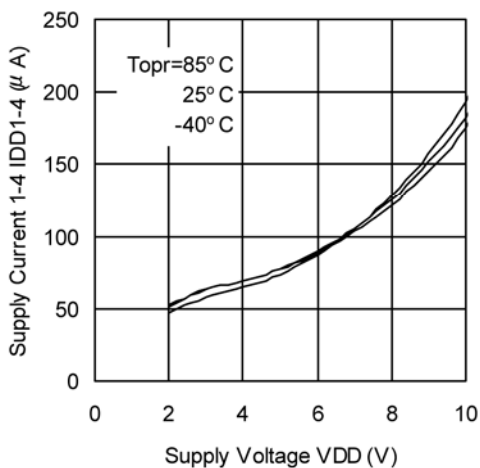

(12) Supply Current 2 vs. Supply Voltage
XC9502B092 (180kHz)

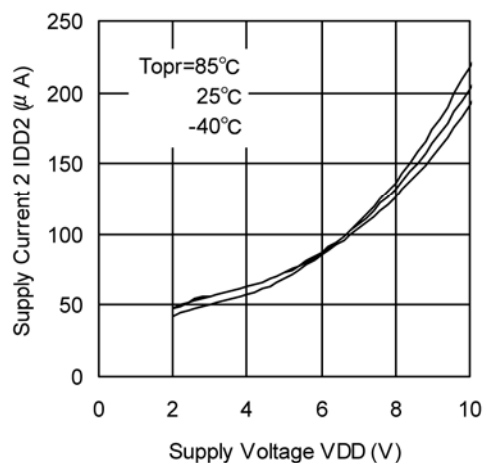

TYPICAL PERFORMANCE CHARACTERISTICS (Continued)

(13) Oscillation Frequency vs. Supply Voltage

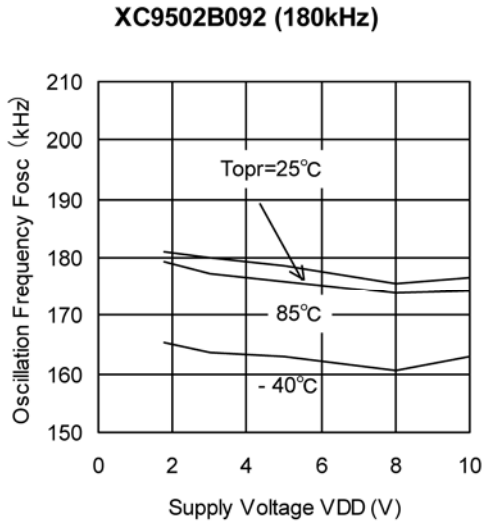

(14) Stand-by Current vs. Supply Voltage

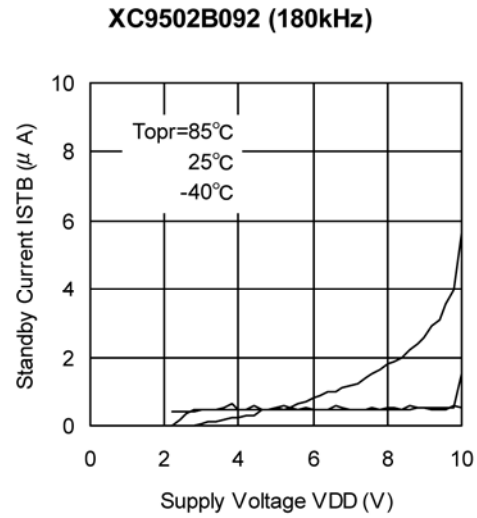

(15) PWM1, 2 'H' 'L' Voltage vs. Supply Voltage

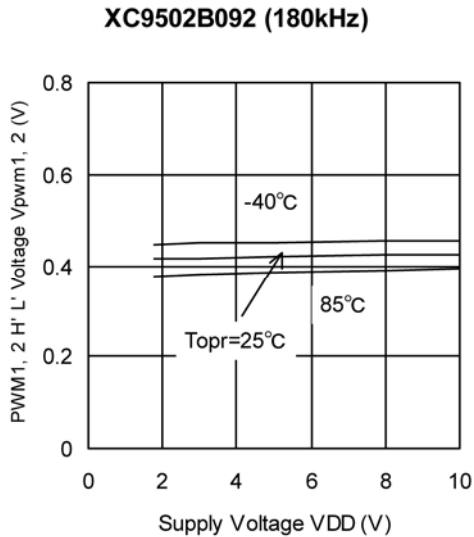

(16) EN1, 2 'H' 'L' Voltage vs. Supply Voltage

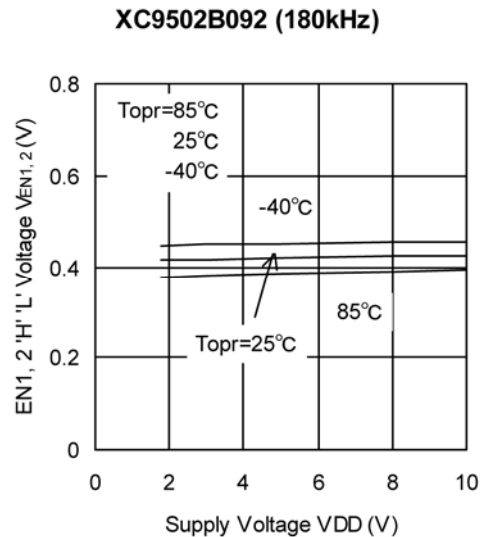

(17) Maximum Duty Ratio 1 vs. Supply Voltage

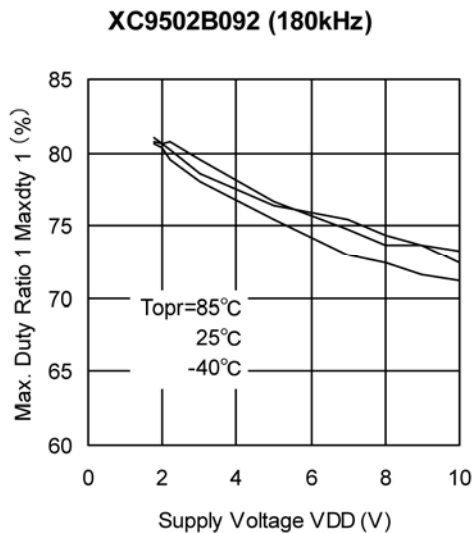

(18) PFM Duty Ratio 1, 2 vs. Supply Voltage

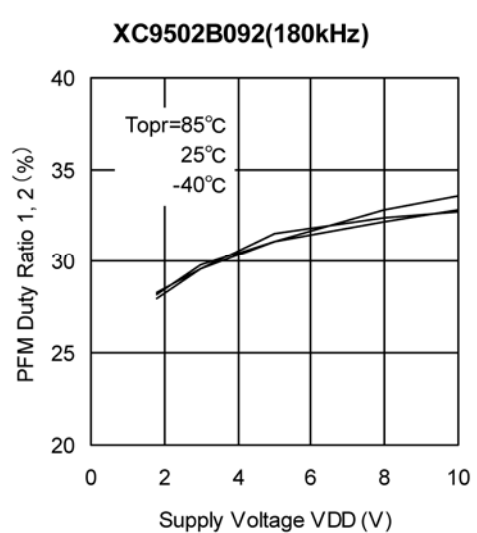

TYPICAL PERFORMANCE CHARACTERISTICS (Continued)

(19) EXT 1, 2 High ON Resistance vs. Supply Voltage

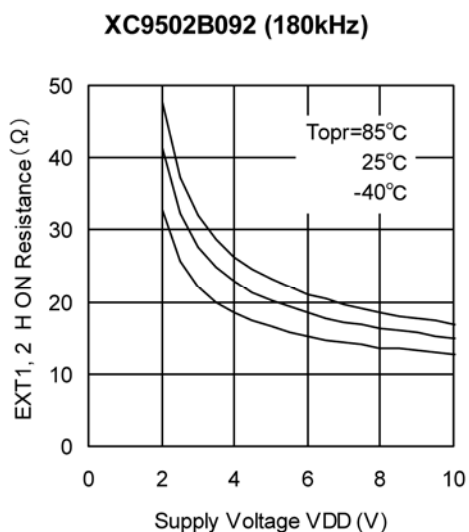

(20) EXT 1, 2 Low ON Resistance vs. Supply Voltage

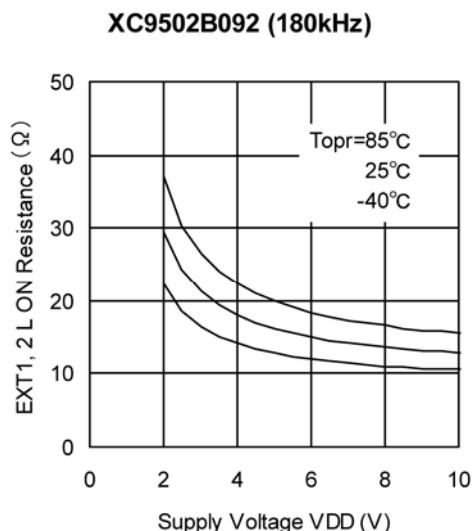

(21) Output Voltage vs. Ambient Temperature

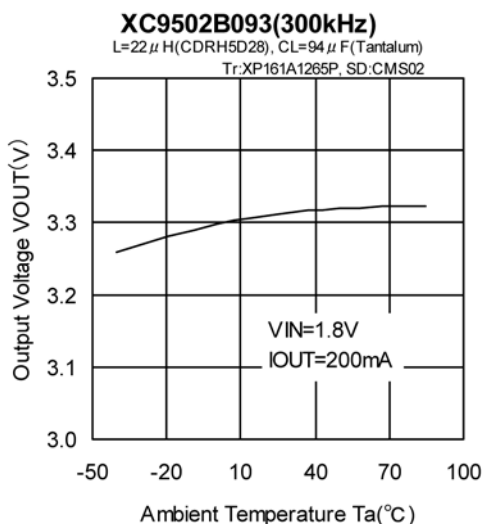

(22) Oscillation Start-Up Voltage vs. Ambient Temperature

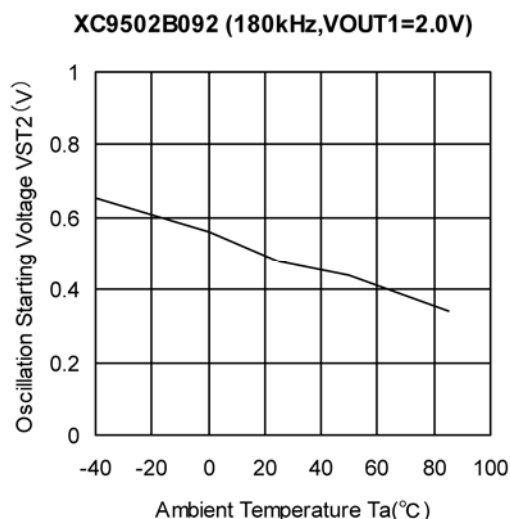

(23) Operation Retention Voltage vs. Ambient Temperature

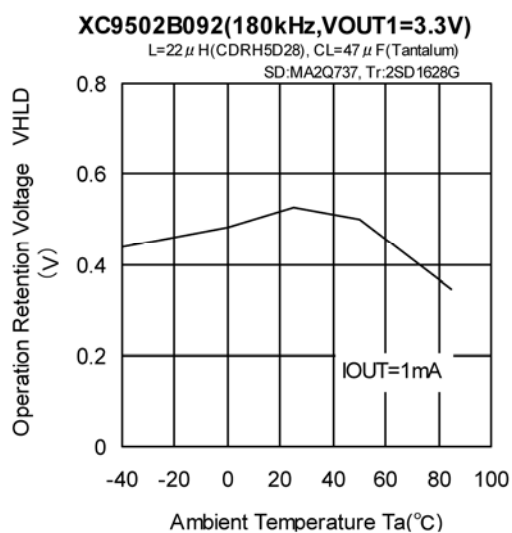

(24) Operation Start-Up Voltage vs. Ambient Temperature

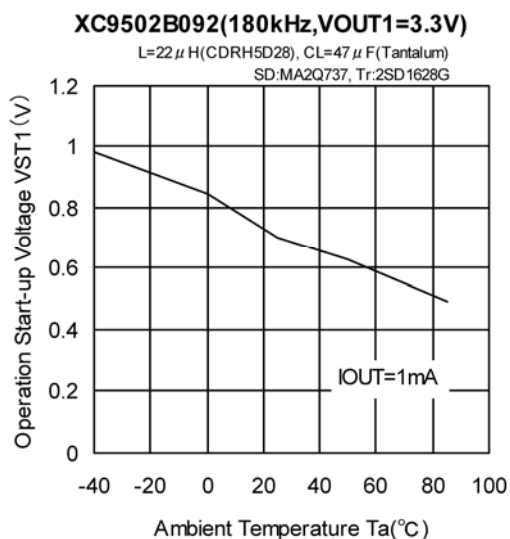

TYPICAL PERFORMANCE CHARACTERISTICS (Continued)

(25) Soft-Start Time 1, 2 vs. Supply Voltage

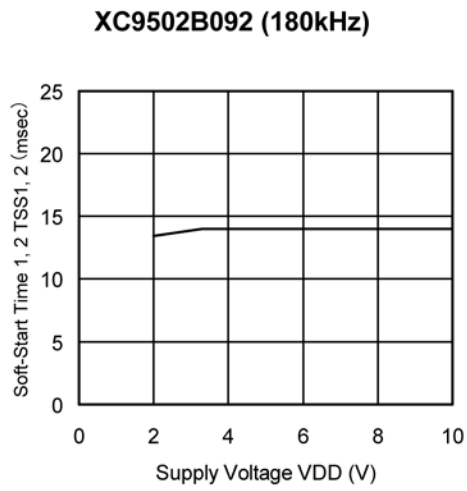

TYPICAL PERFORMANCE CHARACTERISTICS (Continued)

(26) Load Transient Response

[1 channel: Step-Up DC/DC Controller]

< $V_{OUT1} = 3.3V$, $V_{IN} = 2.0V$, $I_{OUT1, 2} = 100\mu A \leftrightarrow 100mA$ >

PWM Control

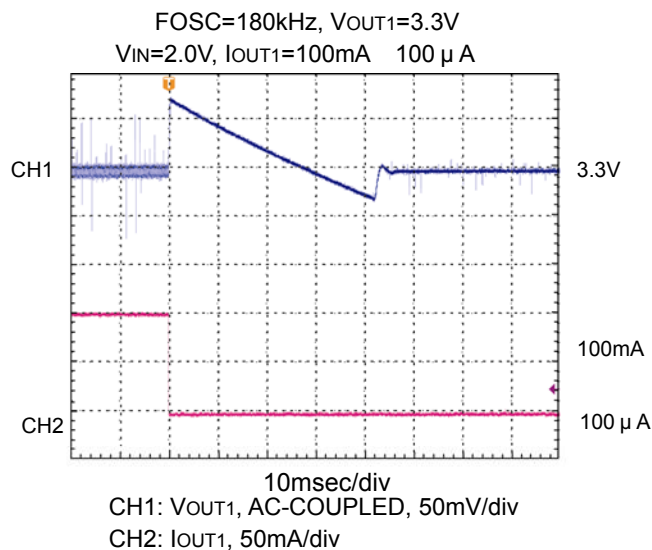
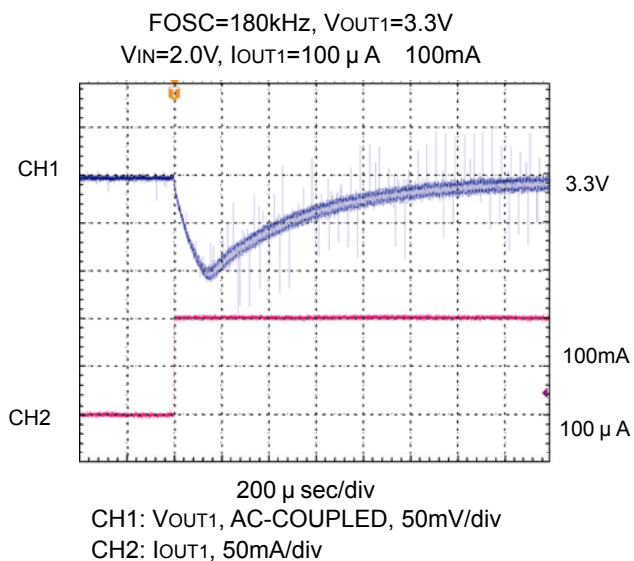

PWM/PFM Switching Control

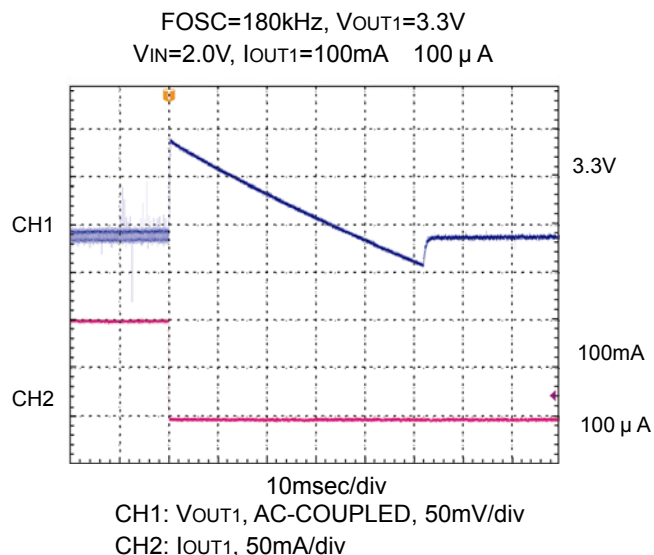
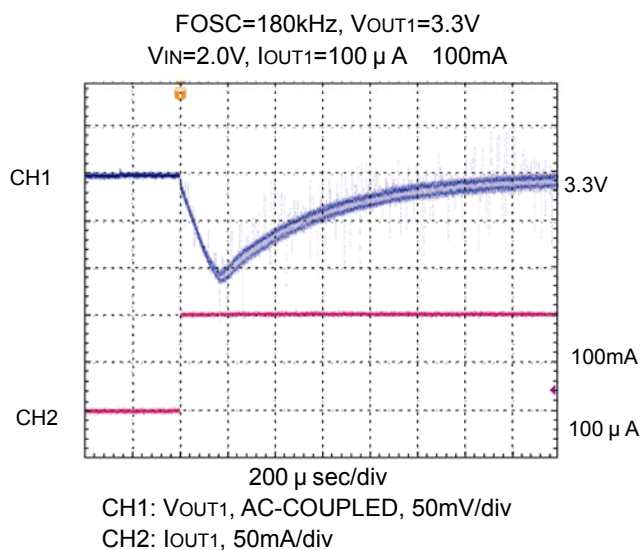

TYPICAL PERFORMANCE CHARACTERISTICS (Continued)

(26) Load Transient Response (Continued)

< $V_{OUT1} = 3.3V$, $V_{IN} = 2.0V$, $I_{OUT1,2} = 10mA \leftrightarrow 100mA$ >

PWM Control

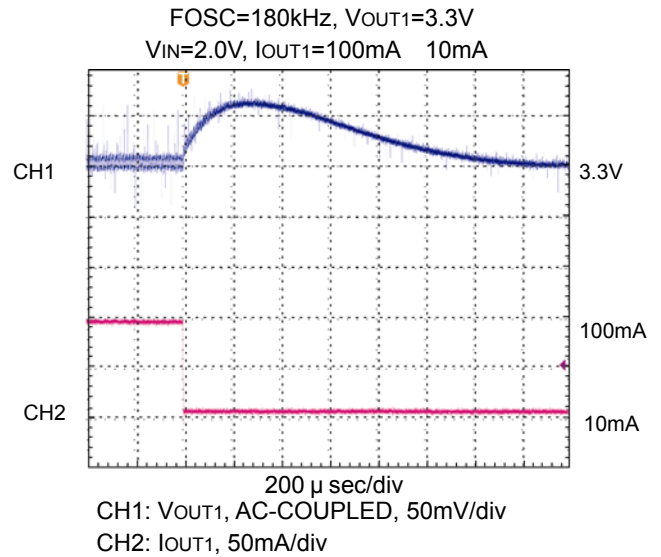
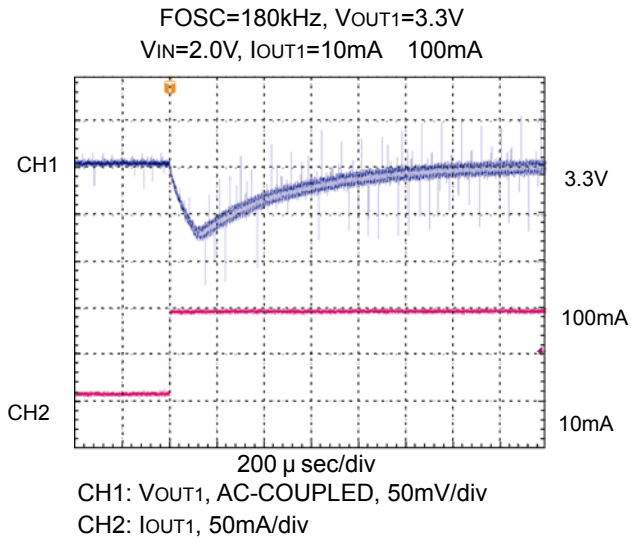

PWM/PFM Switching Control

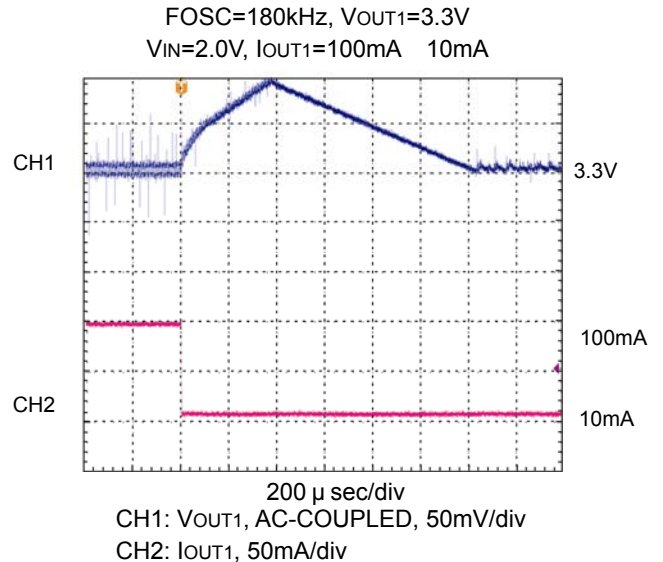
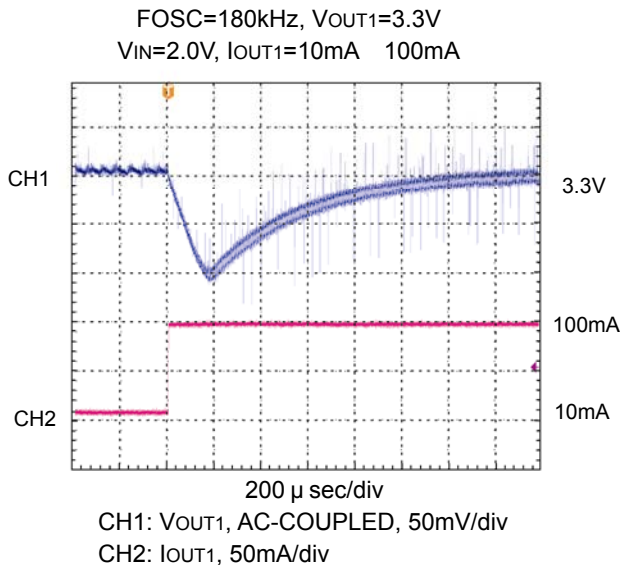

TYPICAL PERFORMANCE CHARACTERISTICS (Continued)

(26) Load Transient Response (Continued)

<PWM Control PWM/PFM Switching Control>

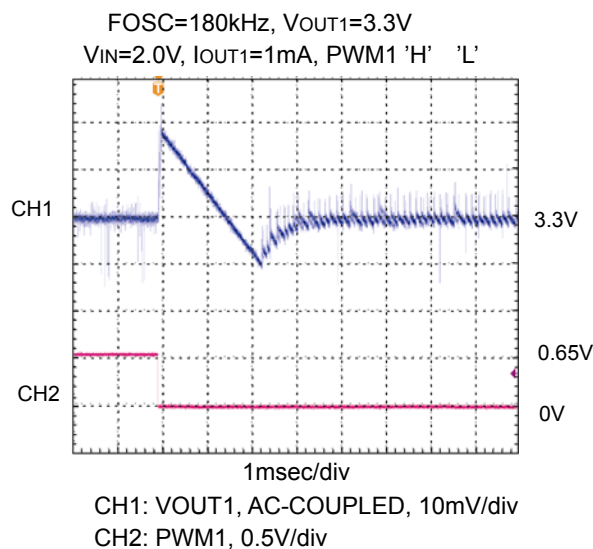
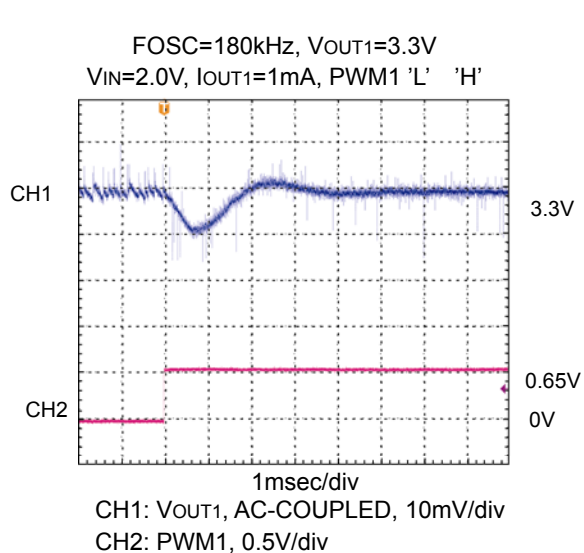

<Soft Start Wave Form>

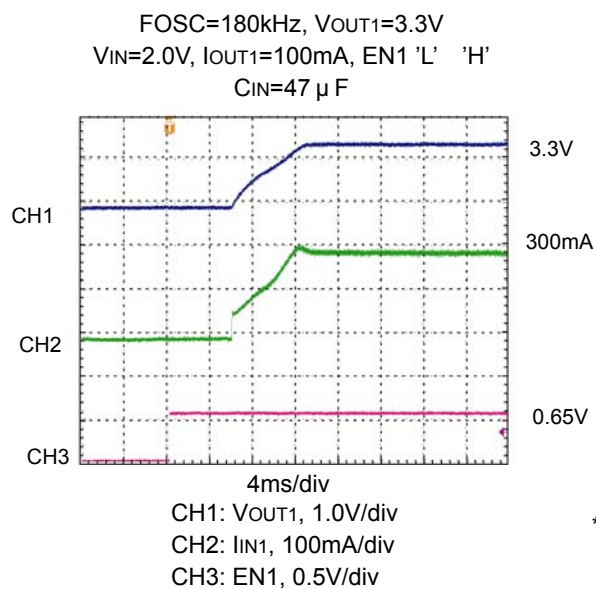

* EN2=GND

TYPICAL PERFORMANCE CHARACTERISTICS (Continued)

(26) Load Transient Response (Continued)

< $V_{OUT2}=3.3V$, $V_{IN}=5.0V$, $I_{OUT2}=100\mu A \leftrightarrow 300mA$ >

PWM Control

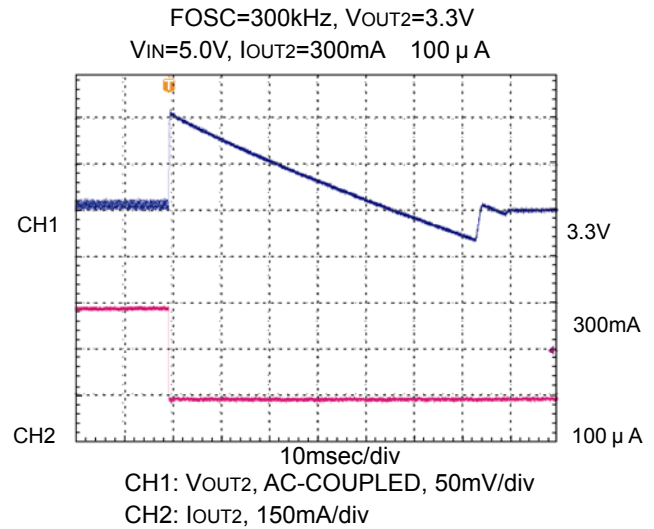
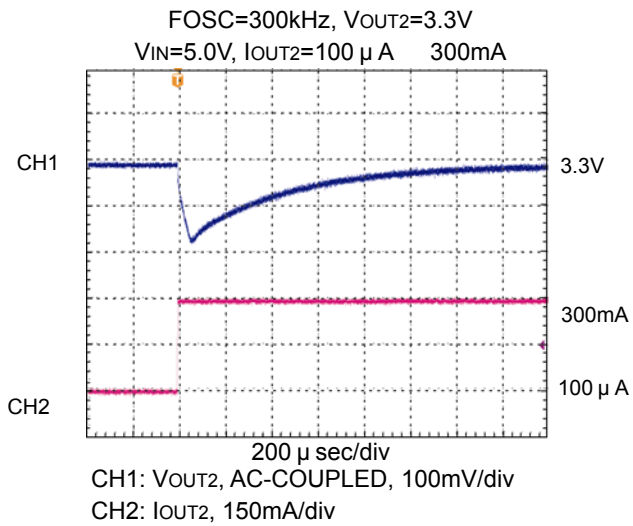

PWM/PFM Switching Control

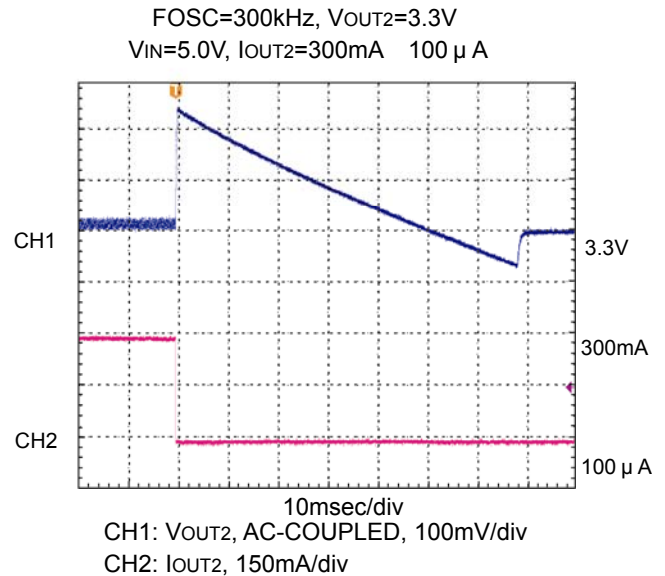
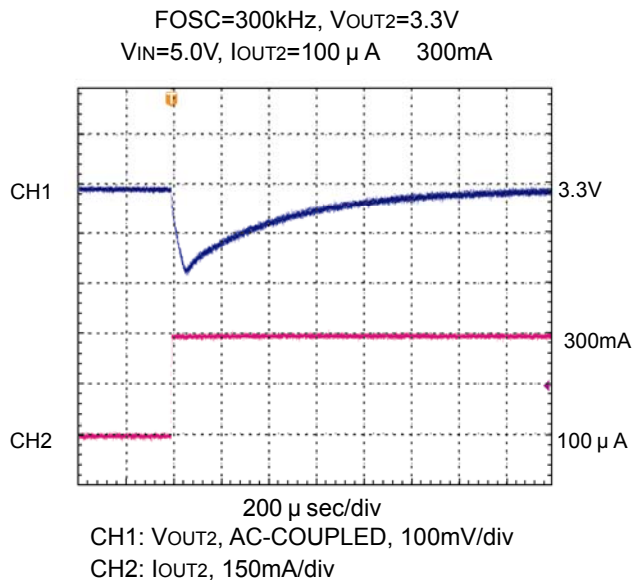

TYPICAL PERFORMANCE CHARACTERISTICS (Continued)

(26) Load Transient Response (Continued)

< $V_{OUT2}=3.3V$, $V_{IN}=5.0V$, $I_{OUT2}=10mA \leftrightarrow 300mA$ >

PWM Control

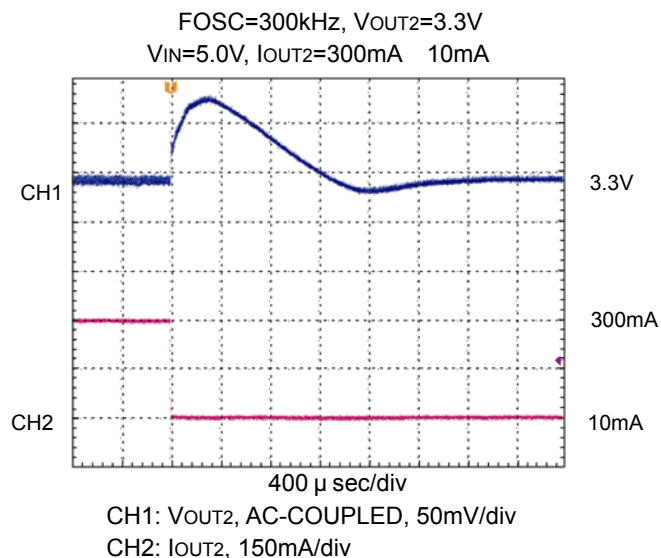
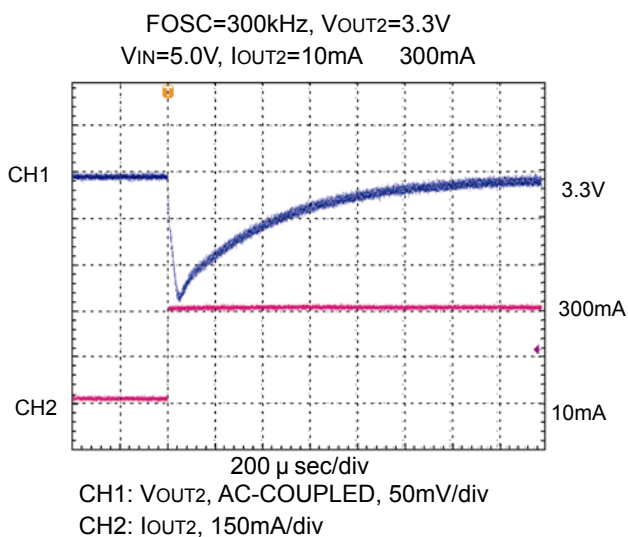

PWM/PFM Switching Control

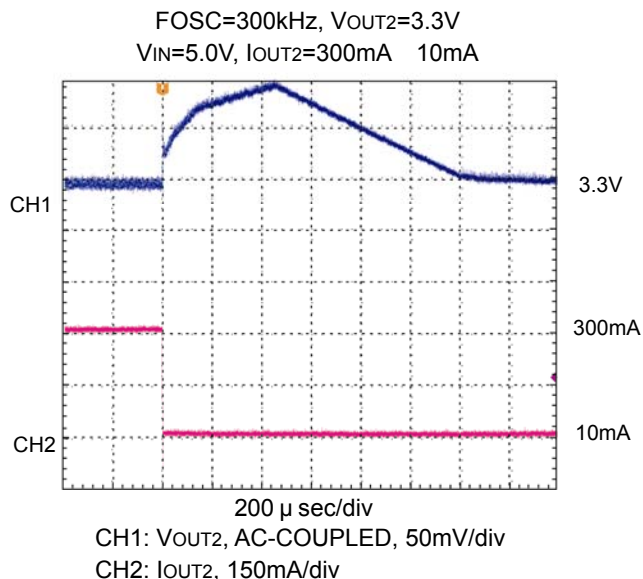
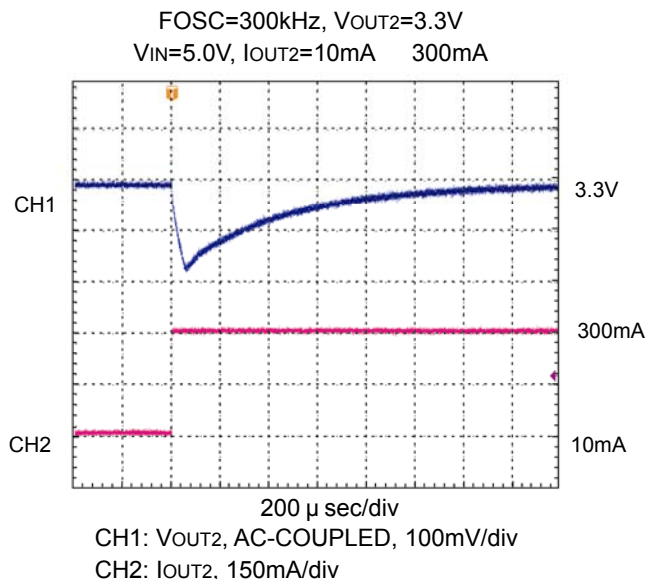

TYPICAL PERFORMANCE CHARACTERISTICS (Continued)

(26) Load Transient Response (Continued)

< $V_{OUT2}=0.9V$, $V_{IN}=3.3V$, $I_{OUT2}=100\mu A \leftrightarrow 300mA$ >

PWM Control

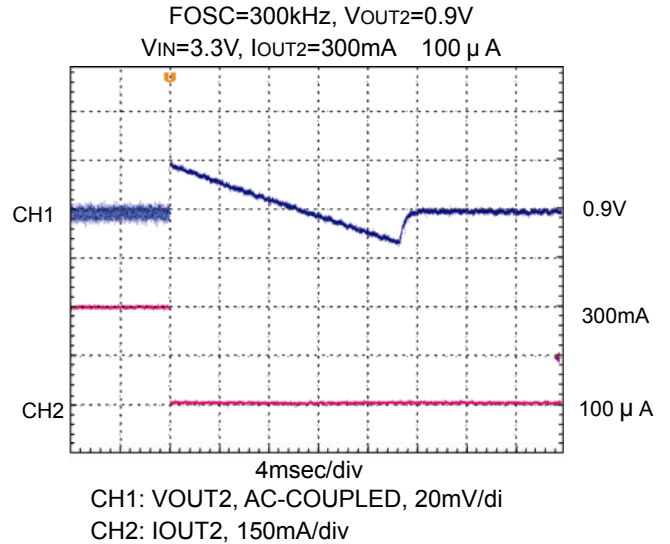
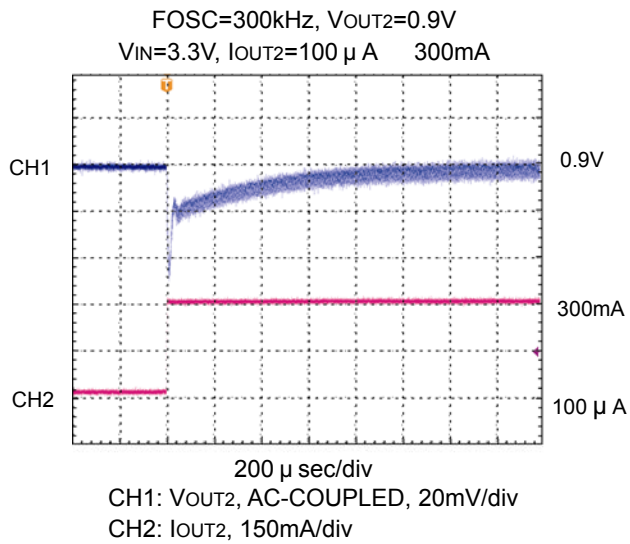

PWM/PFM Switching Control

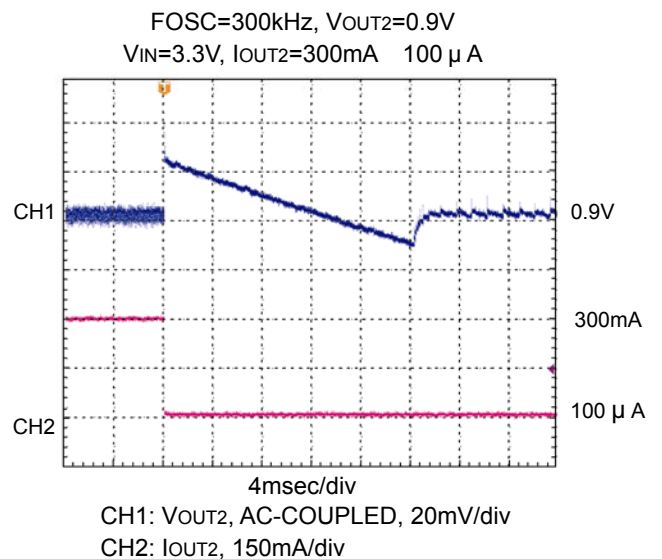
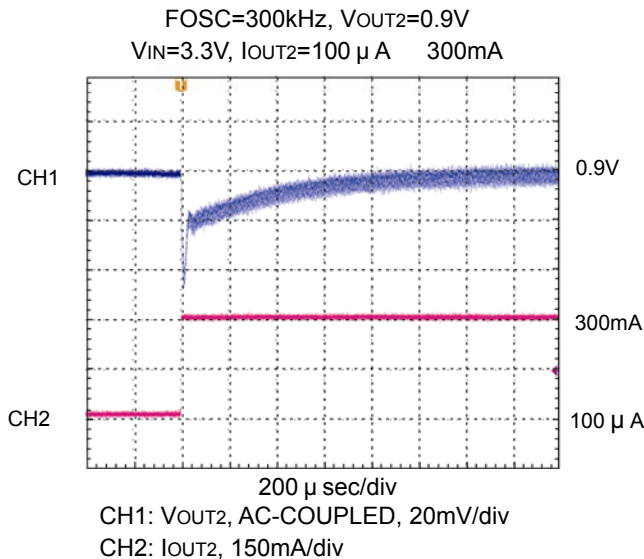

TYPICAL PERFORMANCE CHARACTERISTICS (Continued)

(26) Load Transient Response (Continued)

< $V_{OUT2}=0.9V$, $V_{IN}=3.3V$, $I_{OUT2}=10mA \leftrightarrow 300mA$ >

PWM Control

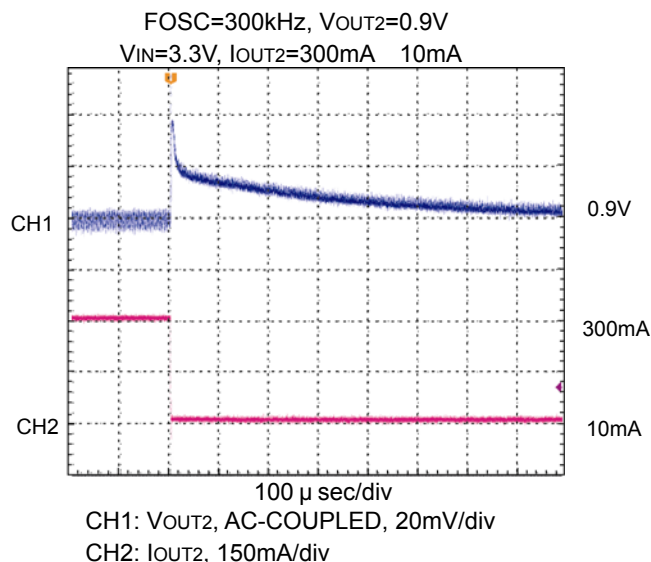
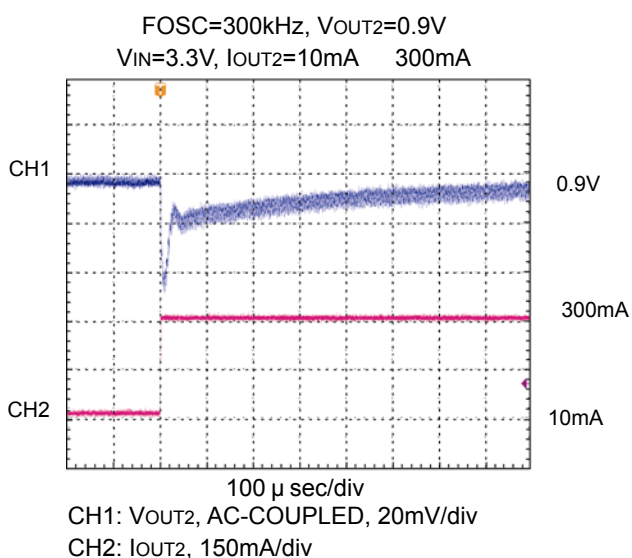

PWM/PFM Switching Control

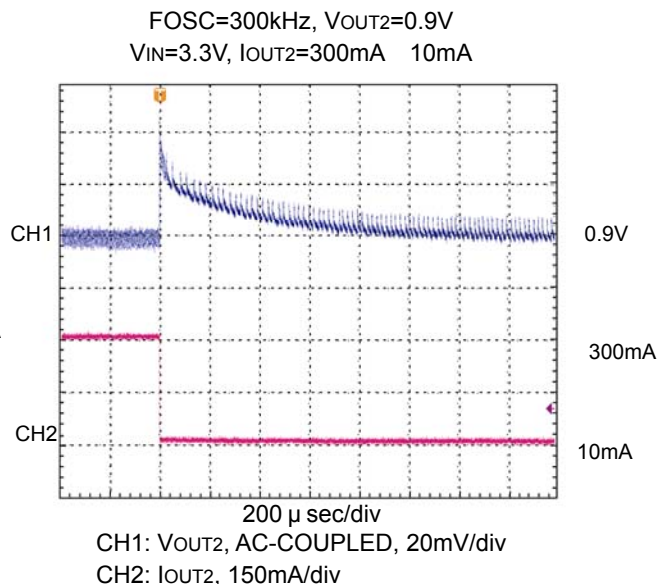
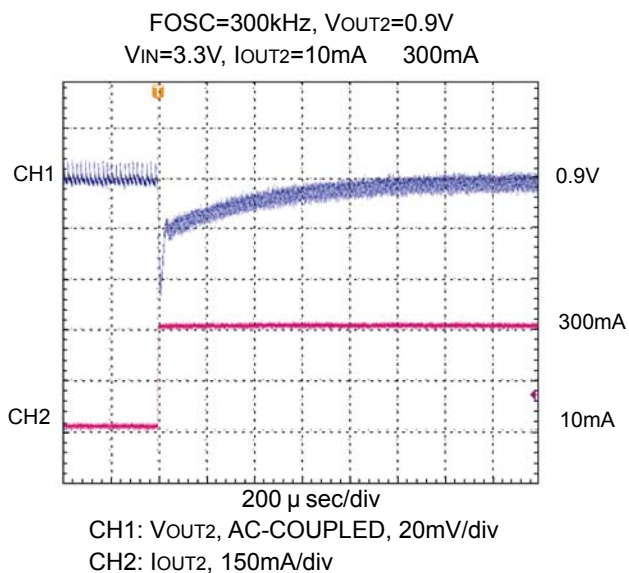

TYPICAL PERFORMANCE CHARACTERISTICS (Continued)

(26) Load Transient Response (Continued)

<PWM Control PWM/PFM Switching Control>

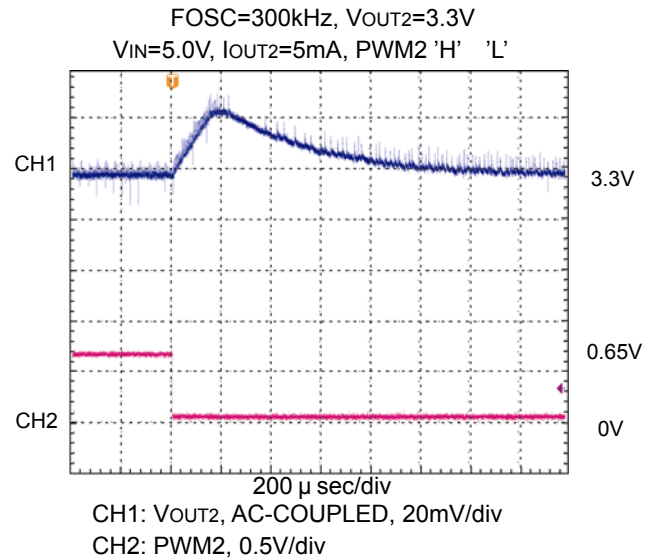
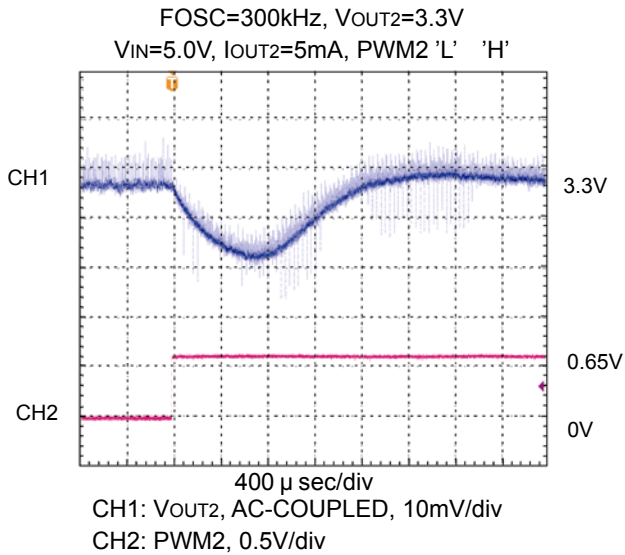

<Soft Start Wave Form>

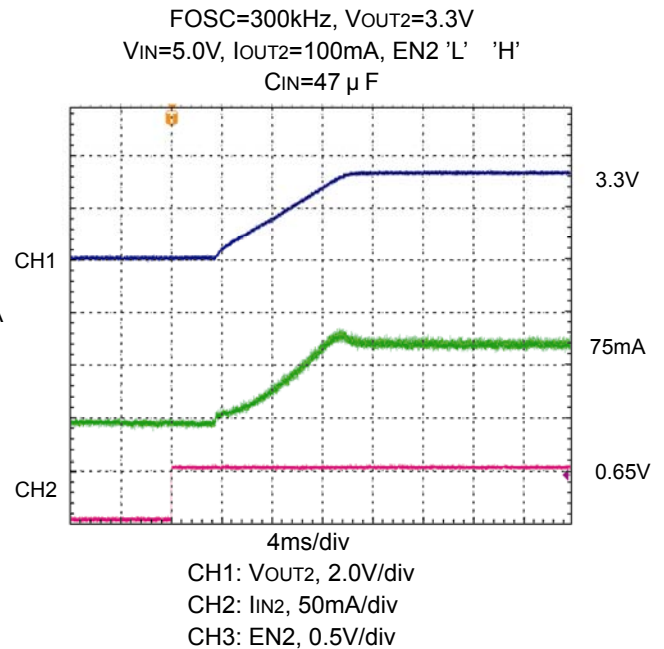
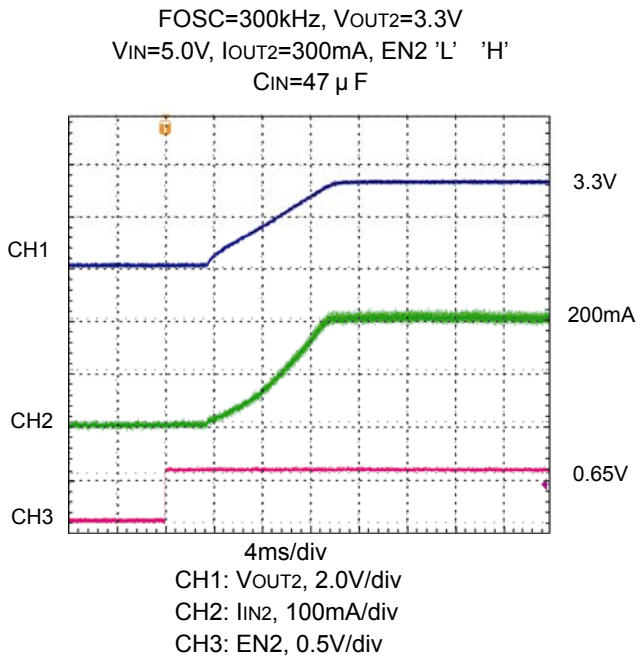

* EN1=GND

PACKAGING INFORMATION

MSOP-10

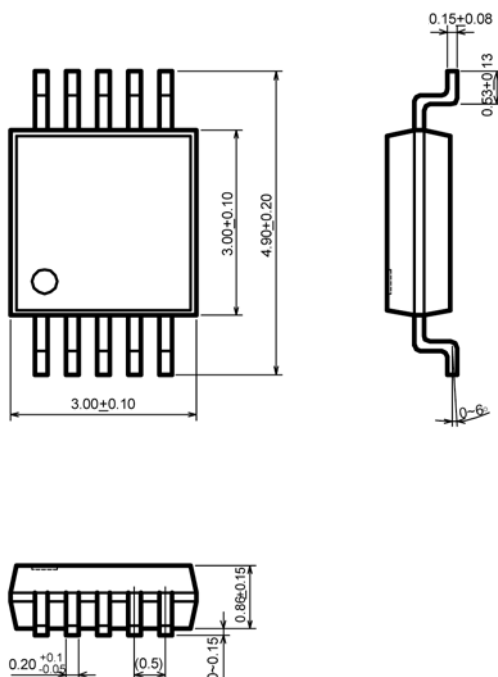

USP-10

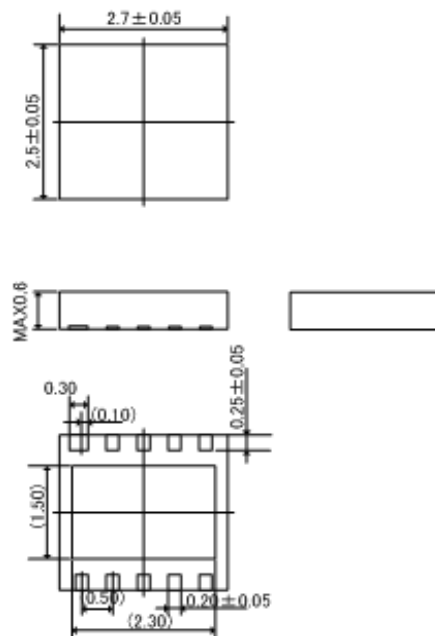

USP-10 Recommended Pattern Layout

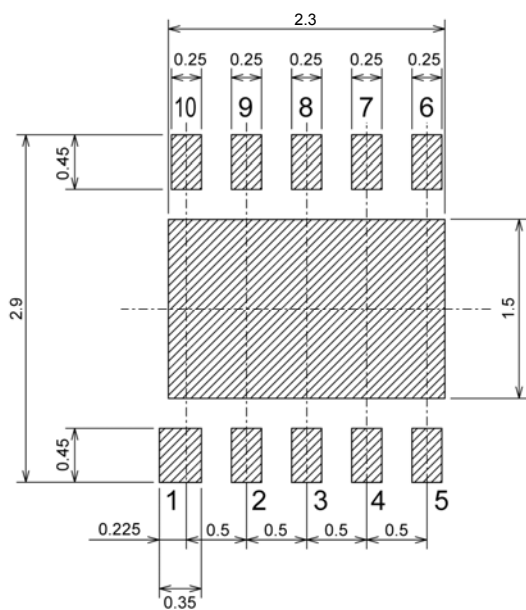

USP-10 Recommended Metal Mask Design

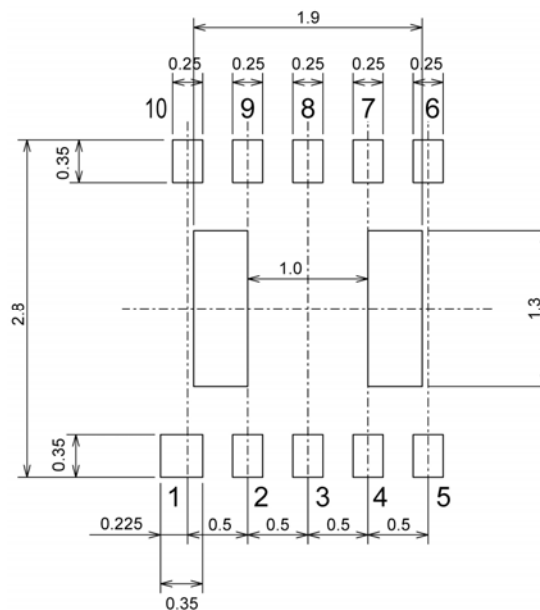

MARKING RULE

MSOP-10, USP-10

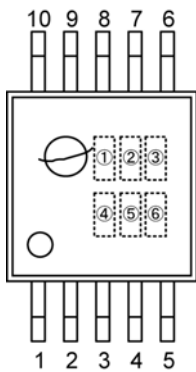

MSOP-10
(TOP VIEW)

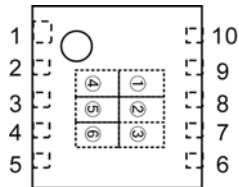

USP-10
(TOP VIEW)

represents product series

| MARK | PRODUCT SERIES |
|------|----------------|
| 3 | XC9502B09xxx |

represents type of DC/DC converter

| MARK | PRODUCT SERIES |
|------|----------------|
| B | XC9502B09xxx |

represents FB voltage

| MARK | | VOLTAGE (V) | PRODUCT SERIES |
|------|---|-------------|----------------|
| 0 | 9 | 0.9 | XC9502B09xxx |

represents oscillation frequency

| MARK | OSCILLATION FREQUENCY (kHz) | PRODUCT SERIES |
|------|-----------------------------|----------------|
| 2 | 180 | XC9502B092xx |
| 3 | 300 | XC9502B093xx |
| 5 | 500 | XC9502B095xx |

represents production lot number

0 to 9, A to Z repeated (G, I, J, O, Q, W excluded)

Note: No character inversion used.

1. The products and product specifications contained herein are subject to change without notice to improve performance characteristics. Consult us, or our representatives before use, to confirm that the information in this datasheet is up to date.
2. We assume no responsibility for any infringement of patents, patent rights, or other rights arising from the use of any information and circuitry in this datasheet.
3. Please ensure suitable shipping controls (including fail-safe designs and aging protection) are in force for equipment employing products listed in this datasheet.
4. The products in this datasheet are not developed, designed, or approved for use with such equipment whose failure or malfunction can be reasonably expected to directly endanger the life of, or cause significant injury to, the user.
(e.g. Atomic energy; aerospace; transport; combustion and associated safety equipment thereof.)
5. Please use the products listed in this datasheet within the specified ranges.
Should you wish to use the products under conditions exceeding the specifications, please consult us or our representatives.
6. We assume no responsibility for damage or loss due to abnormal use.
7. All rights reserved. No part of this datasheet may be copied or reproduced without the prior permission of TOREX SEMICONDUCTOR LTD.

TOREX SEMICONDUCTOR LTD.

单击下面可查看定价，库存，交付和生命周期等信息

[>>Torex Semiconductor\(特瑞仕\)](#)