

## 2 ch. Step-Up / Inverting DC/DC Controller ICs

☆GreenOperation Compatible

## ■GENERAL DESCRIPTION

The XC9504 series are PWM control, PWM/PFM switching, 2 channel (step-up and inverting) DC/DC controller ICs.

With 0.9V of standard voltage supply internal, and using externally connected components, the output 1 voltage (step-up DC/DC controller) can be set freely within a range of 1.5V ~ 30V. Since output 2 (inverting DC/DC controller) has a built-in 0.9V reference voltage (accuracy  $\pm 2\%$ ), a negative voltage can be set with the external components.

With a 180kHz frequency, the size of the external components can be reduced. Oscillation frequencies of 300kHz are also available as custom designed products.

The control of the XC9504 series can be switched between PWM control and PWM/PFM automatic switching control using external signals. Control switches from PWM to PFM during light loads when automatic switching is selected and the series is highly efficient from light loads through to large output currents. Noise is easily reduced with PWM control since the frequency is fixed.

The series gives freedom of control selection so that control suited to the application can be selected.

Soft-start time is internally set to 10ms (output 1) which offers protection against rush currents and voltage overshoot when the power is switched on.

## ■APPLICATIONS

- Power supplies for LCD
- PDAs
- Palm top computers
- Portable audio systems
- Various multi-function power supplies

## ■FEATURES

## 2ch. DC/DC Controller (Step-Up + Inverting)

## &lt;Output 1: Step-Up DC/DC Controller&gt;

- Output Voltage Range : 1.5V ~ 30V (set by FB1 pin)
- Output Current : More than 20mA  
( $V_{IN}=3.3V, V_{OUT}=15V$ )
- Soft-Start Internally Set-Up

## &lt;Output 2: Inverting DC/DC Controller &gt;

- Output Voltage Range : -30V ~ 0V (set by FB2 pin)
- Output Current :  $\geq -20mA$   
( $V_{IN}=3.3V, V_{OUT}=-7.0V$ )

## &lt;Common&gt;

- Supply Voltage Range : 2.0V ~ 10.0V
- Input Voltage Range : 0.9V ~ 10.0V
- Oscillation Frequency : 180kHz ( $\pm 15\%$ )  
\*300kHz, 500kHz custom
- Maximum Duty Cycle : 80% (TYP.)
- Control Method : PWM or PWM/PFM Selectable
- Stand-by Function : 3.0  $\mu F$  (MAX.)
- Packages : MSOP-10, USP-10
- Environmentally Friendly : EU RoHS Compliant, Pb Free

## ■TYPICAL APPLICATION CIRCUIT

<XC9504B092A Input: 3.3V, Output ①: 15V, Output ②: -7V>

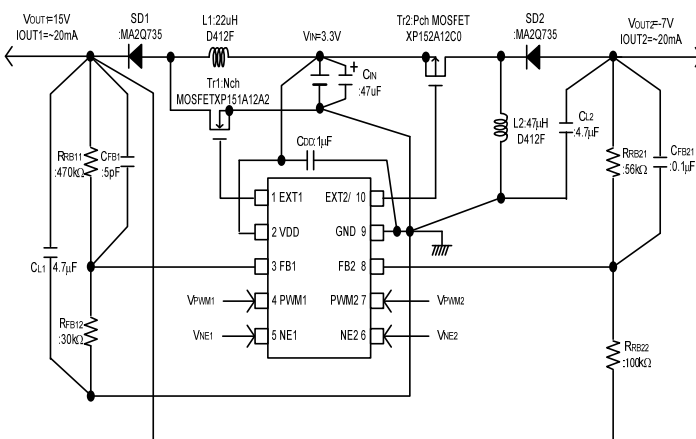

## ■TYPICAL PERFORMANCE CHARACTERISTICS

## ●Output Voltage vs. Output Current

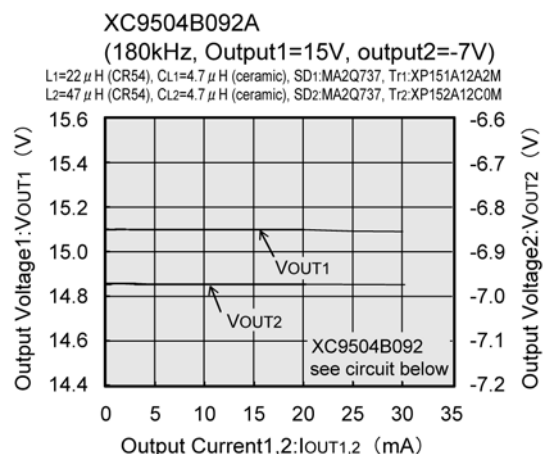

## PIN CONFIGURATION

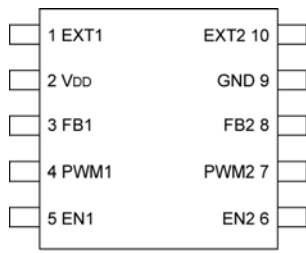

MSOP-10  
(TOP VIEW)

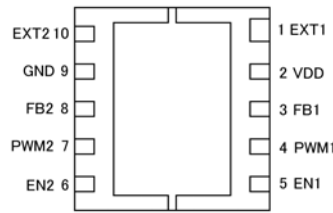

USP-10  
(BOTTOM VIEW)

## PIN ASSIGNMENT

PIN NUMBER	PIN NAME	FUNCTION
1	EXT 1	Channel 1: External Transistor Drive Pin <Connected to N-ch Power MOSFET Gate>
2	V <sub>DD</sub>	Supply Voltage
3	FB1	Channel 1: Output Voltage Monitor Feedback Pin <Threshold value: 0.9V. Output voltage can be set freely by connecting split resistor between V <sub>OUT1</sub> and GND.>
4	PWM1	Channel 1: PWM/PFM Switching Pin <Control Output 1. PMW control when connected to V <sub>DD</sub> , PWM/PFM auto switching when connected to GND.>
5	EN1	Channel 1: Enable Pin <Connected to GND when Output 1 is in stand-by mode. Connected to V <sub>DD</sub> when Output 1 is active. EXT1 is low when in stand-by mode.>
6	EN2	Channel 2: Enable Pin <Connected to GND when Output 2 is in stand-by mode. Connected to V <sub>DD</sub> when Output 2 is active. EXT1 is high when in stand-by mode.>
7	PWM2	Channel 2: PWM/PFM Switching Pin <Control Output 2. PMW control when connected to V <sub>DD</sub> , PWM/PFM auto switching when connected to GND.>
8	FB2	Channel 2: Output Voltage Monitor Feedback Pin <Threshold value: 0.9V. Output voltage can be set freely by connecting split resistor between V <sub>OUT2</sub> and GND.>
9	GND	Ground
10	EXT2/	Channel 2: External Transistor Drive Pin <Connected to P-ch Power MOSFET Gate>

## PRODUCT CLASSIFICATION

### Ordering Information

XC9504 ①②③④⑤⑥-⑦<sup>(\*)</sup>

DESIGNATOR	DESCRIPTION	SYMBOL	DESCRIPTION
①	Type of DC/DC Controller	B	Standard type (10 pin)
②③	Output Voltage	09	FB products⇒②=0, ③=9 fixed
④	Oscillation Frequency	2	180kHz
		3	300kHz (custom)
		5	500kHz (custom)
⑤⑥-⑦	Packages Taping Type <sup>(**)</sup>	AR	MSOP-10
		AR-G	MSOP-10
		DR	USP-10
		DR-G	USP-10

<sup>(\*)</sup> The “-G” suffix indicates that the products are Halogen and Antimony free as well as being fully RoHS compliant.

<sup>(\*\*)</sup> The device orientation is fixed in its embossed tape pocket. For reverse orientation, please contact your local Torex sales office or representative. (Standard orientation: ⑤R-⑦, Reverse orientation: ⑤L-⑦)

## ■ BLOCK DIAGRAM

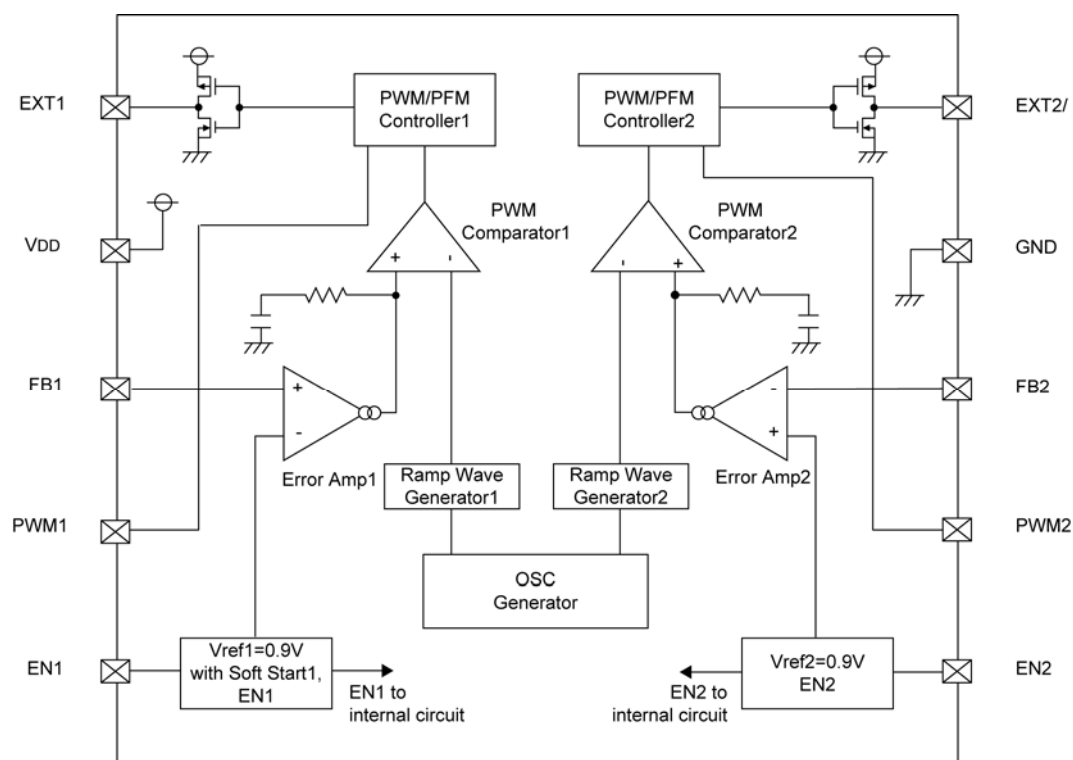

## ■ ABSOLUTE MAXIMUM RATINGS

Ta=25°C

PARAMETER	SYMBOL	RATINGS	UNITS
VDD Pin Voltage	VDD	- 0.3 ~ 12.0	V
FB1, 2 Pin Voltage	VFB	- 0.3 ~ 12.0	V
EN1, 2 Pin Voltage	VEN	- 0.3 ~ 12.0	V
PWM1, 2 Pin Voltage	VPWM	- 0.3 ~ 12.0	V
EXT1, 2 Pin Voltage	VEXT	- 0.3 ~ VDD + 0.3	V
EXT1, 2 Pin Current	IEXT	± 100	mA
Power Dissipation	MSOP-10	150	mW
	USP-10	150	
Operating Temperature Range	Topr	- 40 ~ + 85	°C
Storage Temperature Range	Tstg	- 55 ~ + 125	°C

## ELECTRICAL CHARACTERISTICS

XC9504B092A Common Characteristics

(FOSC = 180kHz) Ta=25°C

PARAMETER	SYMBOL	CONDITIONS	MIN.	TYP.	MAX.	UNITS	CIRCUIT	
Supply Voltage (*1)	VDD		2.0	-	10.0	V	-	
Output Voltage Range (*3)	VOUTSET	VDD ≥ 2.0V IOUT=1mA	VOUT1	0.9	-	-	V	①
			VOUT2	-	-	0.0	V	
		VIN ≥ 0.9V IOUT=1mA (*2)	VOUT1	2.0	-	10.0	V	②
			VOUT2	-	-	0.0	V	
Supply Current 1	IDD1	FB=0V, FB2=0.1	-	90	190	μA	③	
Supply Current 1-1	IDD1-1	EN1=3.0V, EN2=0V, FB1=0V	-	60	120	μA	③	
		EN2=3.0V, EN1=0V, FB2=1.2V						
Supply Current 1-2	IDD1-2	FB1=0V, FB2=0V	-	80	150	μA	③	
		FB1=1.2V, FB2=1.2V						
Supply Current 2	IDD2	FB1=1.2V, FB2=0V	-	70	132	μA	③	
Stand-by Current	ISTB	Same as IDD1, EN1=EN2=0V	-	1.0	3.0	μA	③	
Oscillation Frequency	FOSC	Same as IDD1	153	180	207	kHz	③	
EN1, 2 "High" Voltage	VENH	FB1=3.0V, FB2=0V	0.65	-	-	V	③	
EN1, 2 "Low" Voltage	VENL	FB1=3.0V, FB2=0V	-	-	0.20	V	③	
EN1, 2 "High" Current	IENH	FB1=3.0V, FB2=0V	-	-	0.50	μA	③	
EN1, 2 "Low" Current	IENL	EN1, 2=0V, FB1=3.0V, FB2=0V	-	-	-0.50	μA	③	
PWM1, 2 "High" Current	IPWMH	FB1=3.0V, FB2=0V, PWM1, 2=3.0V	-	-	0.50	μA	③	
PWM1, 2 "Low" Current	IPWML	FB1=3.0V, FB2=0V, PWM1, 2=0V	-	-	-0.50	μA	③	
FB1, 2 "High" Current	IFBH	FB1=3.0V, FB2=0.8V	-	-	0.50	μA	③	
FB1, 2 "Low" Current	VFBL	FB1=1.0V, FB2=0V	-	-	-0.50	μA	③	

Unless otherwise stated, VDD=3.0V, PWM1, 2=3.0V, EN1, 2 = 3.0V

Output 1 Characteristics Step-Up Controller

(FOSC = 180kHz) Ta=25°C

PARAMETER	SYMBOL	CONDITIONS	MIN.	TYP.	MAX.	UNITS	CIRCUIT
FB1 Voltage	VFB1	VDD=3.0V, VIN=1.5V, IOUT=10mA	0.882	0.900	0.918	V	④
Operating Start Voltage 1 (*2)	VST1-1	Using Tr: 2SD1628, IOUT=1.0mA, RFB11=200kΩ, RFB12=75kΩ	-	-	0.9	V	②
		VDD ≠ VOUT1 : IOUT1=10mA	-	-	2.0	V	①
Oscillation Start Voltage 1	VST2-1	FB1=0V	-	-	0.8	V	③
Maximum Duty Ratio 1	MINDTY1	Same as IDD1	75	80	87	%	③
Minimum Duty Ratio 1	MAXDTY1	Same as IDD2	-	-	0	%	③
PFM Duty Ratio 1	PFMDTY1	No Load, VPWM1=0V	22	30	38	%	⑤
Efficiency 1	EFFI1	IOUT1= 130mA, N-ch MOSFET: XP161A1355P	-	85	-	%	⑤
Soft-Start Time 1	TSS1	VOUT1 × 0.95V, EN1=0V → 0.65V	5.0	10.0	20.0	ms	⑤
EXT1 "High" ON Resistance	REXTBH1	FB1=0V, EXT1=VDD -0.4V	-	28	47	Ω	⑥
EXT1 "Low" ON Resistance	REXTBL1	EN1=FB1=1.2V, EXT1=0.4V	-	22	30	Ω	⑥
PWM1 "High" Voltage	VPWMH1	No Load	0.65	-	-	V	⑤
PWM1 "Low" Voltage	VPWML1	No Load	-	-	0.20	V	⑤

Unless otherwise stated, VDD=EN1=PWM1=3.0V, EN2=PWM2=GND, EXT2=OPEN, FB2=OPEN, VIN=1.8V

Output 2 Characteristics Inverting DC/DC Controller

(FOSC = 180kHz) Ta=25°C

PARAMETER	SYMBOL	CONDITIONS	MIN.	TYP.	MAX.	UNITS	CIRCUIT
FB2 Voltage	VFB2	VDD=3.0V	0.882	0.900	0.918	V	③
Operation Start Voltage 2	VST1-2	IOUT=1.0mA, RFB11=200kΩ, RFB12=75kΩ RFB21=17.5kΩ, RFB22=10kΩ, EN1=PWM1=3.0V	-	-	2.0	V	①②
		FB2=1.2V	-	-	2.0	V	③
Maximum Duty Ratio 2	MAXDTY2	Same as IDD1	75	80	87	%	③
Minimum Duty Ratio 2	MINDTY2	Same as IDD2	-	-	0	%	③
PFM Duty Ratio 2	PFMDTY2	No Load, VPWM2=0V	22	30	38	%	⑦
Efficiency 2	EFFI2	IOUT2=-150mA, P-ch MOSFET: XP162A12A6P	-	76	-	%	⑦
EXT2 "High" ON Resistance	REXTBH2	EN2=FB2= 0V, EXT2=VDD-0.4V	-	28	47	Ω	⑥
EXT2 "Low" ON Resistance	REXTBL2	FB2=3.0V, EXT2=0.4V	-	22	30	Ω	⑥
PWM2 "High" Voltage	VPWMH2	No Load	0.65	-	-	V	⑦
PWM2 "Low" Voltage	VPWML2	No Load	-	-	0.20	V	⑦

Unless otherwise stated, VDD=EN2=PWM2=3.0V, PWM1=EN1=GND, EXT1=OPEN, FB1=OPEN, VIN=3.0V

## ■ ELECTRICAL CHARACTERISTICS (Continued)

XC9504B093A Common Characteristics

(FOSC = 300kHz)

Ta=25°C

PARAMETER	SYMBOL	CONDITIONS	MIN.	TYP.	MAX.	UNITS	CIRCUIT	
Supply Voltage <sup>(1)</sup>	VDD		2.0	-	10.0	V	-	
Output Voltage Range <sup>(3)</sup>	VOUTSET	VDD ≥ 2.0V, IOUT=1mA	VOUT1	0.9	-	-	V	①
		VDD ≠ VOUT	VOUT2	-	-	0.0		
		VIN ≥ 0.9V, IOUT=1mA <sup>(2)</sup>	VOUT1	2.0	-	10.0	V	②
		VDD=VOUT	VOUT2	-	-	0.0		
Supply Current 1	IDD1	FB=0V, FB2=1.2V	-	110	250	μA	③	
Supply Current 1-1	IDD1-1	EN1=3.0V, EN2=0, FB1=0V EN2=3.0V, EN1=0V, FB2=1.2V	-	80	150	μA	③	
Supply Current 1-2	IDD1-2	FB1=0V, FB2=0V FB1=1.2V, FB2=1.2V	-	90	200	μA	③	
Supply Current 2	IDD2	FB1=1.2V, FB2=0V	-	80	160	μA	③	
Stand-by Current	ISTB	Same as IDD1, EN1=EN2=0V	-	1.0	3.0	μA	③	
Oscillation Frequency	FOSC	Same as IDD1	255	300	345	kHz	③	
EN1, 2 "High" Voltage	VENH	FB1=0V, FB2=3.0V	0.65	-	-	V	③	
EN1, 2 "Low" Voltage	VENL	FB1=0V, FB2=3.0V	-	-	0.20	V	③	
EN1, 2 "High" Current	IENH	FB1=3.0V, FB2=0V	-	-	0.50	μA	③	
EN1, 2 "Low" Current	IENL	EN1, 2=0V, FB1=3.0V, FB2=0V	-	-	-0.50	μA	③	
PWM1, 2 "High" Current	IPWMH	FB1=3.0V, FB2=0V, PWM1, 2=3.0V	-	-	0.50	μA	③	
PWM1, 2 "Low" Current	IPWML	FB1=3.0V, FB2=0V, PWM1, 2=0V	-	-	-0.50	μA	③	
FB1, 2 "High" Current	IFBH	FB1=3.0V, FB2=0.8V	-	-	0.50	μA	③	
FB1, 2 "Low" Current	VFBL	FB1=1.0V, FB2=0V	-	-	-0.50	μA	③	

Unless otherwise stated, VDD=3.0V, PWM1, 2=3.0V, EN1, 2 = 3.0V

Output 1 Characteristics Step-Up Controller

(FOSC = 300kHz)

Ta=25°C

PARAMETER	SYMBOL	CONDITIONS	MIN.	TYP.	MAX.	UNITS	CIRCUIT
FB 1 Voltage	VFB1	VDD=3.0V, VIN=1.5V, IOUT1=10mA	0.882	0.900	0.918	V	④
Operating Start Voltage 1 <sup>(2)</sup>	VST1-1	Using Tr: 2SD1628, IOUT=1.0mA, RFB11=200kΩ, RFB12=75kΩ	-	-	0.9	V	②
		VDD ≠ VOUT1 : IOUT1=10mA	-	-	2.0	V	①
Oscillation Start Voltage 1	VST2-1	FB1=0V	-	-	0.8	V	③
Maximum Duty Ratio 1	MINDTY1	Same as IDD1	75	80	87	%	③
Minimum Duty Ratio 1	MAXDTY2	Same as IDD2	-	-	0	%	③
PFM Duty Ratio 1	PFMDTY1	No Load, VPWM1=0V	22	30	38	%	⑤
Efficiency 1	EFFI1	IOUT1= 130mA, N-ch MOSFET: XP161A1355P	-	85	-	%	⑤
Soft-Start Time 1	TSS1	VOUT1 × 0.95V, EN1=0V → 0.65V	5.0	10.0	20.0	ms	⑤
EXT1 "High" ON Resistance	REXTBH1	FB1=0V, EXT1=VDD -0.4V	-	28	47	Ω	⑥
EXT1 "Low" ON Resistance	REXTBL1	EN1=FB1=1.2V, EXT1=0.4V	-	22	30	Ω	⑥
PWM1 "High" Voltage	VPWMH1	No Load	0.65	-	-	V	⑤
PWM1 "Low" Voltage	VPWML1	No Load	-	-	0.20	V	⑤

Unless otherwise stated, VDD=EN1=PWM1=3.0V, EN2=PWM2=GND, EXT2=OPEN, FB2=OPEN, VIN=1.8V

Output 2 Characteristics Inverting DC/DC Controller

(FOSC = 300kHz)

Ta=25°C

PARAMETER	SYMBOL	CONDITIONS	MIN.	TYP.	MAX.	UNITS	CIRCUIT
FB 2 Voltage	VFB2	VDD=3.0V	0.882	0.900	0.918	V	③
Operating Start Voltage 2	VST1-2	IOUT2=1.0mA, RFB11=200kΩ, RFB12=75kΩ RFB21=17.5kΩ, RFB22=10k, EN1=PWM1=3.0V	-	-	2.0	V	①②
Oscillation Start Voltage 2	VST2-2	FB2=1.2V	-	-	2.0	V	③
Maximum Duty Ratio 2	MAXDTY2	Same as IDD1	75	80	87	%	③
Minimum Duty Ratio 2	MINDTY3	Same as IDD2	-	-	0	%	③
PFM Duty Ratio 2	PFMDTY2	No Load, VPWM2=0V	22	30	38	%	⑦
Efficiency 2 (*4)	EFFI2	IOUT2= -150mA, P-ch MOSFET: XP162A12A6P	-	75	-	%	⑦
EXT2 "High" ON Resistance	REXTBH2	EN2=FB2= 0V, EXT2=VDD-0.4V	-	28	47	Ω	⑥
EXT2 "Low" ON Resistance	REXTBL2	FB2=3.0V, EXT2=0.4V	-	22	30	Ω	⑥
PWM2 "High" Voltage	VPWMH2	No Load	0.65	-	-	V	⑦
PWM2 "Low" Voltage	VPWML2	No Load	-	-	0.20	V	⑦

Unless otherwise stated, VDD=EN2=PWM2=3.0V, PWM1=EN1=GND, EXT1=OPEN, FB1=OPEN, VIN=3.0V

## ELECTRICAL CHARACTERISTICS (Continued)

XC9504B095A Common Characteristics			(FOSC = 500kHz)				Ta=25°C	
PARAMETER	SYMBOL	CONDITIONS	MIN.	TYP.	MAX.	UNITS	CIRCUIT	
Supply Voltage (*1)	VDD		2.0	-	10.0	V	-	
Output Voltage Range (*3)	VOUTSET	VDD ≥ 2.0V, IOUT=1mA	VOUT1	0.9	-	-	V	①
		VDD ≠ VOUT	VOUT2	-	-	0.0		
		VIN ≥ 0.9V, IOUT=1mA (note 2)	VOUT1	2.0	-	10.0	V	②
		VDD=VOUT	VOUT2	-	-	0.0		
Supply Current 1	IDD1	FB=0V, FB2=1.2V	-	165	350	μA	③	
Supply Current 1-1	IDD1-1	EN1=3.0V, EN2=0, FB1=0V EN2=3.0V, EN1=0V, FB2=1.2V	-	110	220	μA	③	
Supply Current 1-2	IDD1-2	FB1=0V, FB2=0V FB1=1.2V, FB2=1.2V	-	130	270	μA	③	
Supply Current 2	IDD2	FB1=1.2V, FB2=0V	-	100	200	μA	③	
Stand-by Current	ISTB	Same as IDD1, EN1=EN2=0V	-	1.0	3.0	μA	③	
Oscillation Frequency	FOSC	Same as IDD1	425	500	575	kHz	③	
EN1, 2 "High" Voltage	VENH	FB1=0V, FB2=3.0V	0.65	-	-	V	③	
EN1, 2 "Low" Voltage	VENL	FB1=0V, FB2=3.0V	-	-	0.20	V	③	
EN1, 2 "High" Current	IENH	FB1=3.0V, FB2=0V	-	-	0.50	μA	③	
EN1, 2 "Low" Current	IENL	EN1, 2=0V, FB1=3.0V, FB2=0V	-	-	-0.50	μA	③	
PWM1, 2 "High" Current	IPWMH	FB1=3.0V, FB2=0V, PWM1, 2=3.0V	-	-	0.50	μA	③	
PWM1, 2 "Low" Current	IPWML	FB1=3.0V, FB2=0V, PWM1, 2=0V	-	-	-0.50	μA	③	
FB1, 2 "High" Current	IFBH	FB1=3.0V, FB2=0.8V	-	-	0.50	μA	③	
FB1, 2 "Low" Current	VFBL	FB1=1.0V, FB2=0V	-	-	-0.50	μA	③	

Unless otherwise stated, VDD=3.0V, PWM1, 2=3.0V, EN1, 2 = 3.0V

Output 1 Characteristics Step-Up Controller			(FOSC = 500kHz)				Ta=25°C
PARAMETER	SYMBOL	CONDITIONS	MIN.	TYP.	MAX.	UNITS	CIRCUIT
FB 1 Voltage	VFB1	VDD=3.0V, VIN=1.5V, IOUT1=10mA	0.882	0.900	0.918	V	④
Operating Start Voltage 1 <sup>(2)</sup>	VST1-1	Using Tr: 2SD1628, IOUT=1.0mA, RFB11=200kΩ, RFB12=75kΩ	-	-	0.9	V	②
		VDD ≠ VOUT1 : IOUT1=10mA	-	-	2.0	V	①
Oscillation Start Voltage 1	VST2-1	FB1=0V	-	-	0.8	V	③
Maximum Duty Ratio 1	MINDTY1	Same as IDD1	75	80	87	%	③
Minimum Duty Ratio 1	MAXDTY2	Same as IDD2	-	-	0	%	③
PFM Duty Ratio 1	PFMDTY1	No Load, VPWM1=0V	22	30	38	%	⑤
Efficiency 1	EFFI1	IOUT1= 130mA, N-ch MOSFET: XP161A1355P	-	83	-	%	⑤
Soft-Start Time 1	TSS1	VOUT1 × 0.95V, EN1=0V → 0.65V	5.0	10.0	20.0	ms	⑤
EXT1 "High" ON Resistance	REXTBH1	FB1=0V, EXT1=VDD-0.4V	-	28	47	Ω	⑥
EXT1 "Low" ON Resistance	REXTBL1	EN1=FB1=1.2V, EXT1=0.4V	-	22	30	Ω	⑥
PWM1 "High" Voltage	VPWMH1	No Load	0.65	-	-	V	⑤
PWM1 "Low" Voltage	VPWML1	No Load	-	-	0.20	V	⑤

Unless otherwise stated, VDD=EN1=PWM1=3.0V, EN2=PWM2=GND, EXT2=OPEN, FB2=OPEN, VIN=1.8V

Output 2 Characteristics Inverting DC/DC Controller			(FOSC = 500kHz)				Ta=25°C
PARAMETER	SYMBOL	CONDITIONS	MIN.	TYP.	MAX.	UNITS	TEST CIRCUIT
FB 2 Voltage	VFB2	VDD=3.0V	0.882	0.900	0.918	V	③
Operating Start Voltage 2	VST1-2	IOUT2=1.0mA, RFB11=200kΩ, RFB12=75kΩ RFB21=17.5kΩ, RFB22=10kΩ, EN1=PWM1=3.0V	-	-	2.0	V	①②
Oscillation Start Voltage 2	VST2-2	FB2=1.2V	-	-	2.0	V	③
Maximum Duty Ratio 2	MAXDTY2	Same as IDD1	75	80	87	%	③
Minimum Duty Ratio 2	MINDTY2	Same as IDD2	-	-	0	%	③
PFM Duty Ratio 2	PFMDTY2	No Load, VPWM2=0V	22	30	38	%	⑦
Efficiency 2 <sup>(4)</sup>	EFFI2	IOUT2= -150mA, P-ch MOSFET: XP162A12A6P	-	71	-	%	⑦
EXT2 "High" ON Resistance	REXTBH2	EN2=FB2= 0V, EXT2=VDD-0.4V	-	28	47	Ω	⑥
EXT2 "Low" ON Resistance	REXTBL2	FB2=3.0V, EXT2=0.4V	-	22	30	Ω	⑥
PWM2 "High" Voltage	VPWMH2	No Load	0.65	-	-	V	⑦
PWM2 "Low" Voltage	VPWML2	No Load	-	-	0.20	V	⑦

Unless otherwise stated, VDD=EN2=PWM2=3.0V, PWM1=EN1=GND, EXT1=OPEN, FB1=OPEN, VIN=3.0V

## ■ ELECTRICAL CHARACTERISTICS (Continued)

### NOTE:

- \*1 Although the IC's step-up switching operations start from a  $V_{DD}$  of 0.8V, the output voltage and oscillation frequency are stabilized at  $V_{DD} \geq 2.0V$ . Therefore, a  $V_{DD}$  of more than 2.0V is recommended when  $V_{DD}$  is supplied from  $V_{IN}$  or other power sources.
- \*2 Although the IC's operations start from a  $V_{IN}$  of 0.9V, the IC's power supply pin ( $V_{DD}$ ) and output voltage monitor pin (FB1) should be connected to  $V_{OUT1}$ . With operations from  $V_{IN}=0.9V$ , the 2nd channel's (output 2) EN2 pin should be disabled. Once output voltage  $V_{OUT1}$  is more than 2.0V, the EN2 pin should be enabled.
- \*3 Please be careful not to exceed the breakdown voltage level of the peripheral parts.
- \*4  $EFFI = \{ [ (\text{output voltage}) \times (\text{output current}) ] / [ (\text{input voltage}) \times (\text{input current}) ] \} \times 100$

## ■ OPERATIONAL EXPLANATION

The XC9504 series are dual DC/DC (step-up + inverting) converter controller ICs with built-in high speed, low ON resistance buffers.

### <Error Amp. 1>

Error amplifier 1 is designed to monitor the output voltage and it compares the feedback voltage1 (FB1) with the reference voltage Vref1. In response to feedback of a voltage lower than the reference voltage Vref1, the output voltage of the error amp. decreases

### <Error Amp. 2>

Error amplifier 2 is designed to monitor the output voltage and it compares the feedback voltage 2 (FB2) with the reference voltage Vref 2. In response to feedback of a voltage lower than the reference voltage Vref2, the output voltage of the error amp. decreases.

### <OSC Generator>

This circuit generates the internal reference clock.

### <Ramp Wave Generator 1, 2>

The ramp wave generator generates a saw-tooth waveform based on outputs from the OSC generator.

### <PWM Comparator 1, 2>

The PWM comparator compares outputs from the error amp. and saw-tooth waveform. When the voltage from the error amp's output is low, the external will be set to ON.

### <PWM/PFM Controller 1, 2>

This circuit generates PFM pulses.

Control can be switched between PWM control and PWM/PFM automatic switching control using external signals.

The PWM/PFM automatic switching mode is selected when the voltage of the PWM1 (2) pin is less than 0.2V, and the control switches between PWM and PFM automatically depending on the load. As the PFM circuit generates pulses based on outputs from the PWM comparator, shifting between modes occurs smoothly. PWM control mode is selected when the voltage of the PWM1 (2) pin is more than 0.65V. Noise is easily reduced with PWM control since the oscillation frequency is fixed. Control suited to the application can easily be selected which is useful in audio applications, for example, where traditionally, efficiencies have been sacrificed during stand-by as a result of using PWM control (due to the noise problems associated with the PFM mode in stand-by).

### <Vref 1 with Soft Start 1>

The reference voltage, Vref1 (FB1 pin voltage)=0.9V, is adjusted and fixed by laser trimming (for output voltage settings, please refer to the functional settings notes below.). To protect against inrush current, when the power is switched on, and also to protect against voltage overshoot, soft-start time is set internally to 10ms. It should be noted, however, that this circuit does not protect the load capacitor (CL) from inrush current. With the Vref voltage limited, and depending upon the input to error amp 1, the operation maintains a balance between the two inputs of error amps and controls the EXT pin's ON time so that it doesn't increase more than is necessary.

### <Vref 2>

The reference voltage, Vref2 (FB2 pin voltage)=0.9V, is adjusted and fixed by laser trimming.

### <Enable Function 1,2>

This function controls the operation and shutdown of the IC. When the voltage of the EN1 or EN2 pins is 0.2V or less, the mode will be disable, the channel's operations will stop and the EXT1 pin will be kept at a low level (the external N-ch MOSFET will be OFF) and the EXT2 pin will be kept at a high level (the external P-ch MOSFET will be OFF). When both EN1 and EN2 are in a state of chip disable, current consumption will be no more than 3.0  $\mu$  A.

When the EN1 or EN2 pin's voltage is 0.65V or more, the mode will be enable and operations will recommence. With channel one (output 1) soft-start, 95% of the set output voltage will be reached within 10msec (TYP.) from the moment of enable.



## ■ OPERATIONAL EXPLANATION (Continued)

< Output Voltage Setting, Ch.1 (Step-Up DC/DC Converter Controller) >

Output voltage can be set by adding external split resistors. Output voltage is determined by the following equation, based on the values of RFB11 and RFB12. The sum of RFB11 and RFB12 should normally be 1 MΩ or less.

$$V_{OUT1} = 0.9 \times (R_{FB11} + R_{FB12}) / R_{FB12}$$

The speed-up capacitor for phase compensation's (CFB1) value should be adjusted using the formula  $f_{zfb} = 1 / (2 \times \pi \times C_{FB1} \times R_{FB11})$  so that it equals 12kHz. Depending on the application, the inductance value L, and the load capacity value CL, adjustments to this value are suggested so that the value is somewhere between 1kHz to 50kHz.

[Calculation Example]

When  $R_{FB11} = 470k\Omega$  and  $R_{FB12} = 30k\Omega$  :  $V_{OUT1} = 0.9 \times (470k + 30k) / 30k = 15.0V$ .

[Typical Example]

VOUT (V)	RFB11 (kΩ)	RFB12 (kΩ)	CFB1 (pF)	VOUT (V)	RFB11 (kΩ)	RFB12 (kΩ)	CFB1 (pF)	VOUT (V)	RFB11 (kΩ)	RFB12 (kΩ)	CFB1 (pF)
1.5	220	330	62	2.7	360	180	33	10.0	680	68	18
1.8	220	220	62	3.0	560	240	24	12.0	160	13	82
2.0	330	330	39	3.3	200	75	62	15.0	470	30	27
2.2	390	390	33	5.0	82	18	160	20.0	470	22	27
2.5	390	390	33	8.0	120	15	100	30.0	390	12	34

< Output Voltage Setting, Ch. 2 (Inverting DC/DC Converter) >

Output voltage can be set by adding reference voltage and split resistors externally. Output voltage is determined using the following equation and is based on the values of RFB21 and RFB22. The sum of RFB21 and RFB22 should normally be 200kΩ or less. The equation uses Ch 1's (VOUT1) output voltage calculation method for the reference voltage.

$$V_{OUT2} = (0.9 - V_{OUT1}) \times (R_{FB21} / R_{FB22}) + 0.9V$$

[Calculation Example]

When  $R_{FB21} = 17.5k\Omega$ ,  $R_{FB22} = 10k\Omega$ ,  $V_{OUT1} = 3.3V$ ,  $V_{OUT2} = -3.3V$

The value of speed-up capacitor for phase compensation CFB21:

**[Conditions: Heavy load (when coil current is continuous.)]**

$$f_{zfb2} = 1 / 2 \times \pi \times C_{FB21} \times R_{FB21} = 10kHz$$

Depending on the application, the inductance value L, and the load capacity value CL, adjustments to this value are suggested so that the value is somewhere between 1kHz to 50kHz.

**[Conditions: Light load (when coil current is discontinuous.)]**

Less than  $C_{FB21} = 0.1 \mu F$

Depending on the application, the inductance value L, and the load capacity value CL, adjustments to this value are suggested.

> Example Circuit 1: Using voltage of Ch 1 (Step-Up)

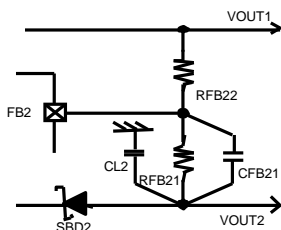

Channel 1 (Step-Up) circuits should be enable by setting EN1 to High level so that a stable voltage is provided. Inrush current to the inverter when the supply voltage VDD of the IC is 2.0 V or higher can be controlled by setting EN 1 and EN 2 to enable ("H" level) simultaneously.

> Example Circuit 2: Using a positive regulator

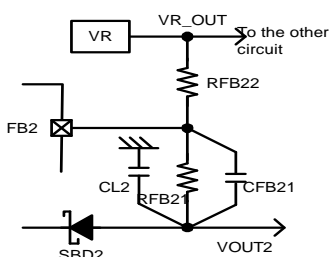

A stable positive voltage produced by a positive voltage regulator or by other means is usable.

$$V_{OUT2} = (0.9 - V_{R_{OUT}}) \times (R_{FB21} / R_{FB22}) + 0.9V$$

## NOTES ON USE

### External Components

**Conditions: Light load (when coil current is discontinuous.)**

#### Channel One: Step-Up DC/DC Converter Controller ICs

\* MOSFET

Tr.1: XP151A12A2 (N-ch Power MOSFET, TOREX)  
 Note: V<sub>GS</sub> break down voltage of the XP151A12A2 is 12V so please be careful with the power supply voltage.

SD1: MA2Q737 (Schottky diode, MATSUSHITA)

L1: 15 μH (D412F, TOKO, FOSC=300kHz)

22 μH (D412F, TOKO, FOSC=180kHz)

Please set so that the coil current is discontinuous.

CL1: 25V, 4.7 μF (Ceramic)

\* NPN Tr.

Tr.1: 2SD1628 (SANYO)

RB1: 500Ω Adjust in accordance with load & Tr.'s hFE.

$$RB1 \leq (VIN - 0.7) \times (hFE/IC - REXTBH)$$

CB1: 2200pF (Ceramic)

$$CB1 \leq (2 \pi \times RB1 \times FOSC \times 0.7)$$

#### Channel Two: Inverter DC/DC Converter

\* MOSFET

Tr.2: XP151A12C0 (P-ch Power MOSFET, TOREX)  
 Note: V<sub>GS</sub> break down voltage of the XP151A12C0 is 12V so please be careful with the power supply voltage.

SD2: MA2Q737 (Schottky diode, MATSUSHITA)

L2: 22 μH (D412F, TOKO, FOSC=300kHz)

44 μH (D412F, TOKO, FOSC=180kHz)

Please set so that the coil current is discontinuous.

CL2: 10V, 4.7 μF (Ceramic)

\* PNP Tr.

Tr.2: 2SA1213 (TOSHIBA)

RB2: 500Ω Adjust in accordance with load & Tr.'s hFE.

$$RB2 \leq (VIN - 0.7) \times (hFE/IC - REXTBL)$$

CB2: 2200pF (Ceramic)

$$CB2 \leq (2 \pi \times RB2 \times FOSC \times 0.7)$$

**Conditions: Light load (when coil current is discontinuous.)**

#### Channel One: Step-Up DC/DC Converter Controller ICs

\* MOSFET

Tr.1: XP151A12A2 (N-ch Power MOSFET, TOREX)  
 Note: V<sub>GS</sub> break down voltage of the XP151A12A2 is 12V so please be careful with the power supply voltage.

SD1: MA2Q737 (Schottky diode, MATSUSHITA)

L1: 15 μH (CDRH5D28, SUMIDA, FOSC=300kHz)

22 μH (CDRH5D28, SUMIDA, FOSC=180kHz)

CL1: 16V, 4.7 μF (Tantalum)  
 Increase capacity according to the equation below when the step-up voltage ratio is large and output current is high.

$$CL = (CL \text{ standard value}) \times (IOUT1 \text{ (mA)} / 300\text{mA} \times VOUT1 / VIN)$$

\* NPN Tr.

Tr.1: 2SD1628 (SANYO)

RB1: 500Ω Adjust in accordance with load & Tr.'s hFE.

$$RB1 \leq (VIN - 0.7) \times (hFE/IC - REXTBH)$$

CB1: CB1 ≤ (2 π × RB1 × FOSC × 0.7)

#### Channel Two: Inverter DC/DC Converter

\* MOSFET

Tr.2: XP151A12C0 (P-ch Power MOSFET, TOREX)  
 Note: V<sub>GS</sub> break down voltage of the XP151A12C0 is 12V so please be careful with the power supply voltage.

SD2: MA2Q737 (Schottky diode, MATSUSHITA)

CRS02, (Schottky diode, TOSHIBA)  
 CMS02

L2: 15 μH (CDRH5D28, SUMIDA, FOSC=300kHz)

22 μH (CDRH5D28, SUMIDA, FOSC=180kHz)

CL2: 16V, 4.7 μF (Tantalum)  
 Increase capacity according to the equation below when the step-up voltage ratio is large and output current is high.

$$CL = (CL \text{ standard value}) \times (IOUT2 \text{ (mA)} / 300\text{mA} \times VOUT2 / VIN)$$

\* PNP Tr.

Tr.2: 2SA1213 (TOSHIBA)

RB2: 500Ω Adjust in accordance with load & Tr.'s hFE.

$$RB2 \leq (VIN - 0.7) \times (hFE/IC - REXTBL)$$

CB2: 2200pF (Ceramic)

$$CB2 \leq (2 \pi \times RB2 \times FOSC \times 0.7)$$

## ■ NOTES ON USE (Continued)

### ● Hint on application

#### 1. Channel 1 (Step-Up) How to shut down the output voltage during standby mode

If the circuit configuration shown as an example of typical application circuits is used, voltage  $V_{IN}$  will occur at  $V_{OUT1}$  when the IC is in standby, the diode being bypassed. This can cause circuits connected to  $V_{OUT1}$  to malfunction.

#### > Example of typical application circuit 1:

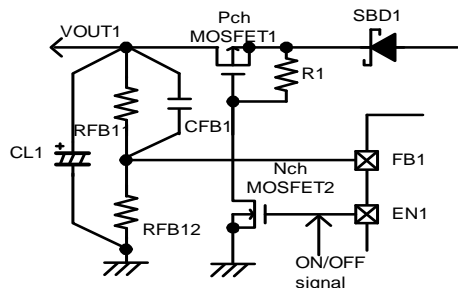

Set R1 so as to prevent leakage current of N-ch MOSFET 2.

#### > Example of typical application circuit 2: Power Ready Function

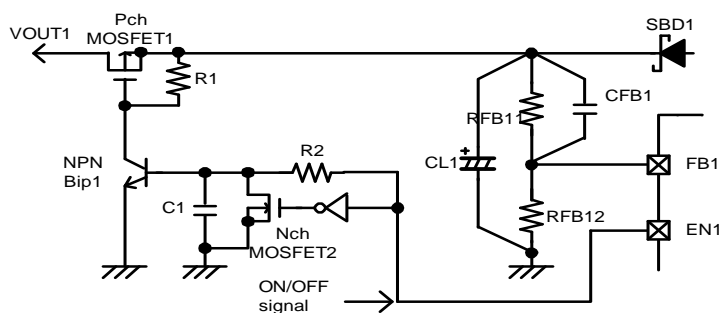

Time to make power ready is calculated by the equation below.

$$Time = -R2 \times C1 \times \ln(1 - 0.7 / [ON / OFF Signal Voltage])$$

Set R1 so as to prevent leakage current of NPN (Bip 1).

N-ch MOSFET 2 and the inverter enables power to be turned off quickly.

The combination of R 2, C 1, and the threshold voltage of approximately 0.7 V of NPN Bip 1 is used to produce a delay time between the circuits being enabled and P-ch MOSFET 1 being switched on. Delay time set to 20ms ensures power to be made ready in a favorable manner, as soft start of this product is completed during the delay time.

Set Value (Example)

VOLTAGE (V)	R2 (kΩ)	C1 (μF)
2.5	430	0.15
3.3	470	0.18
5.0	430	0.33

#### 2. Channel 2 (Inverting): Soft start circuit

Channel 2 (inverting) is subject to the overshoot of output voltage 2 ( $V_{OUT2}$ ) at start-up. It is possible to control the overshoot of output voltage 2 ( $V_{OUT2}$ ), as shown by circuit example 1 in "Output Voltage Settings for Channel 2" in "Function Settings." In this circuit configuration, EN 1 and EN 2 are enabled (set to "H" level) simultaneously. This lets output voltage 1 ( $V_{OUT1}$ ) of channel 1 increase gently as soft start, thereby controlling the overshoot.

#### > Example of typical application circuit: Improved Soft start

This example is effective when EN 1 and EN 2 are enabled with different timings under light load condition (the coil current being discontinuous).

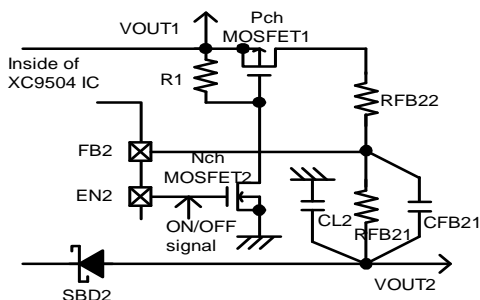

Time to make soft start time is calculated by the equation below.

$$Time_{ss2} = -RFB21 \times CFB21 / \ln \left( 1 - \frac{(0.9 - V_{OUT2}) \times RFB22}{(V_{OUT1} - 0.9) \times RFB21} \right)$$

Example)

When  $V_{OUT1} = 15V$  and  $V_{OUT2} = -7.5V$ ,

$RFB21 = 59.6k\Omega$ ,  $RFB22 = 100k\Omega$  by the equation below.

$$V_{OUT2} = (0.9 - V_{OUT1}) \times (RFB21 / RFB22) + 0.9$$

When the light load,  $CFB21 = 0.1\mu F$  or lower value can be used.

Therefore, when  $CFB21 = 0.027\mu F$ ,

$Time_{ss2} = 5.0ms$  and  $V_{OUT2} = 95\%$  of setting value

#### 3. Channel 2 (Inverting): Withstand voltage of transistor

The voltage applied between the drain and source is the sum of  $V_{IN}$  and  $V_{OUT2}$ . Select a transistor with an absolute  $V_{DSS}$  rating that is suitable for your operating conditions. Example: The voltage applied across  $V_{DS}$  of a transistor will be 20.0V if  $V_{IN} = 5.0V$  and  $V_{OUT2} = -15.0V$ . Under this condition, a transistor with  $V_{DSS}$  higher than 20.0V should be selected. (Use a transistor with  $V_{DSS}$  that is 1.5 times the applied voltage or more, as a standard.)

## TEST CIRCUITS

Circuit 1

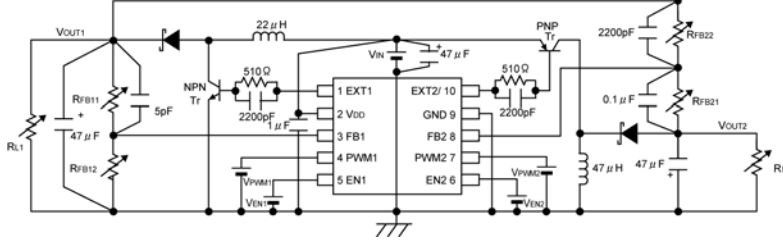

Circuit 2

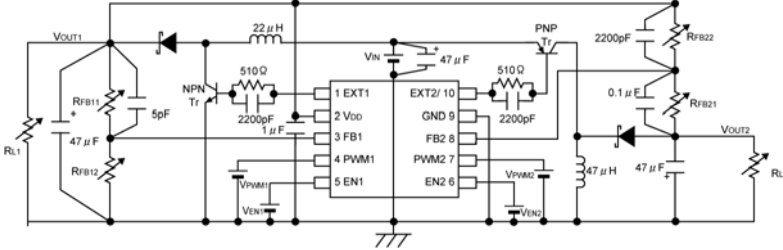

Circuit 3

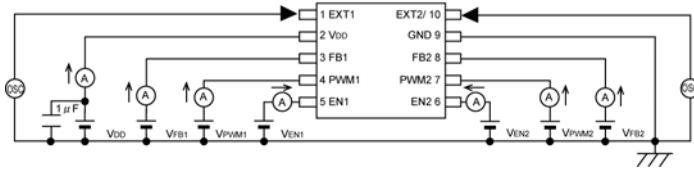

Circuit 4

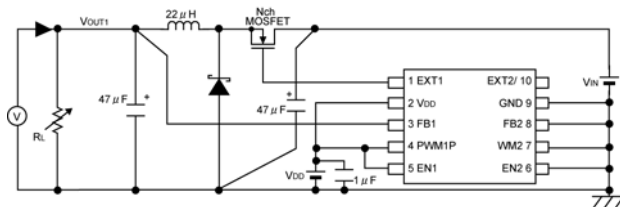

■ TEST CIRCUITS(Continued)

Circuit 5

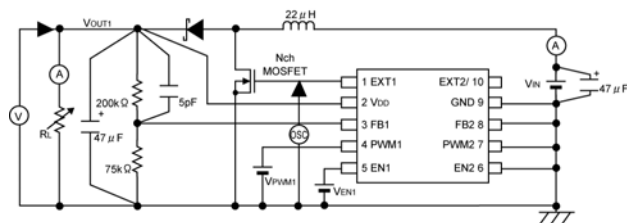

Circuit 6

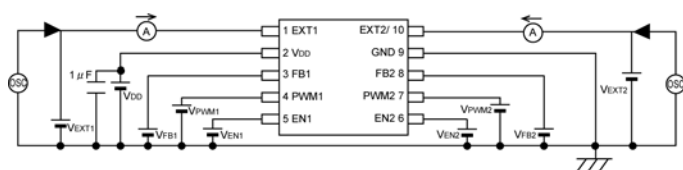

Circuit 7

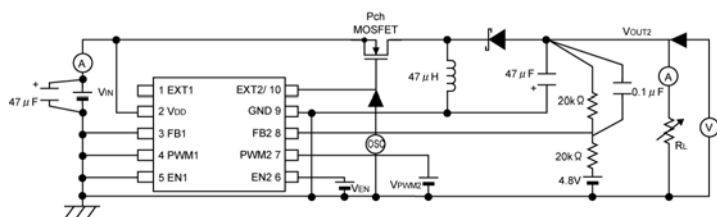

## EXTERNAL COMPONENTS USED FOR THE TEST CIRCUITS

### Circuit 1, Circuit 2

L1, L2: 22  $\mu$  H (CDRH5D28, SUMIDA) : XC9504B092A  
 15  $\mu$  H (CDRH5D28, SUMIDA) : XC9504B093A  
 10  $\mu$  H (CDRH5D28, SUMIDA) : XC9504B095A  
 SD1, SD2 : CRS02 (Schottky, TOSHIBA)  
 EC10QS06 (Schottky, NIHON INTER)  
 CL1, CL2 : 16MCE476MD2 (Tantalum, NIHON CHEMICON)  
 35MCE335MB x 3 (Tantalum, NIHON CHEMICON)  
 C<sub>IN</sub> : 16MCE476MD2  
 NPN Tr 1 : 2SD1628 (SANYO)  
 PNP Tr 2 : 2SA1213 (TOSHIBA)  
 RFB : Please use by the conditions as below.  
 $R_{FB11} + R_{FB12} \leq 1M\Omega$   
 $R_{FB21} + R_{FB22} \leq 1M\Omega$   
 $R_{FB11} / R_{FB12} = (\text{Setting Output Voltage} / 0.9) - 1$   
 $V_{OUT2} = (0.9 - V_{OUT1}) / (R_{FB21} / R_{FB22}) + 0.9$   
 $f_{zfb} = 1 / (2 \times \pi \times C_{FB1} \times R_{FB11}) = 1\text{kHz to } 50\text{kHz (12kHz usual)}$   
 $f_{zfb} = 1 / (2 \times \pi \times C_{FB2} \times R_{FB21}) = 1\text{kHz to } 50\text{kHz (12kHz usual)}$

### Circuit 4

L1 : 22  $\mu$  H (CDRH5D28 SUMIDA)  
 SD 1 : MA2Q737 (Schottky, MATSUSHITA)  
 CL 1 : 16MCE476MD2 (Tantalum, NIHONCHEMICON)  
 C<sub>IN</sub> : 16MCE476MD2 (Tantalum, NIHONCHEMICON)  
 N-ch MOSFET : XP161A1355P (TOREX)

### Circuit 5

L1 : 22  $\mu$  H (CDRH5D28, SUMIDA) : XC9504B092A  
 15  $\mu$  H (CDRH5D28, SUMIDA) : XC9504B093A  
 10  $\mu$  H (CDRH5D28, SUMIDA) : XC9504B095A  
 SD 1 : MA2Q737 (Schottky, MATSUSHITA)  
 CL 1 : 16MCE476MD2 (Tantalum, NIHONCHEMICON)  
 C<sub>IN</sub> : 16MCE476MD2 (Tantalum, NIHONCHEMICON)  
 N-ch MOSFET : XP161A1355P (TOREX)

### Circuit 7

L2 : 22  $\mu$  H (CDRH5D28, SUMIDA) : XC9504B092A  
 15  $\mu$  H (CDRH5D28, SUMIDA) : XC9504B093A  
 10  $\mu$  H (CDRH5D28, SUMIDA) : XC9504B095A  
 SD 2 : MA2Q737 (Schottky, MATSUSHITA)  
 CL 2 : 16MCE476MD2 (Tantalum, NIHONCHEMICON)  
 C<sub>IN</sub> : 16MCE476MD2 (Tantalum, NIHONCHEMICON)  
 P-ch MOSFET : XP162A12A6P (TOREX)

## NOTE ON USE

### 1. PWM/PFM Automatic Switching

If PWM/PFM automatic switching control is selected and the step-up ratio is low (e.g., from 4.5 V to 5.0 V), the control mode remains in PFM setting over the whole load range, since the duty ratio under continuous-duty condition is smaller than the PFM duty ratio of the XC9504 series. The output voltage's ripple voltage becomes substantially high under heavy load conditions, with the XC9504 series appearing to be producing an abnormal oscillation. If this operation becomes a concern, set pins PWM to High to set the control mode to PWM setting. For use under the above-mentioned condition, measured data of PWM/PFM automatic switching control shown on the data sheets are available up to I<sub>OUT</sub> = 100 mA.

### 2. Ratings

Use the XC9504 series and peripheral components within the limits of their ratings.

## ■ TYPICAL PERFORMANCE CHARACTERISTICS

< 1 ch. Step-Up DC/DC Controller >

(1) Output Voltage vs. Output Current

(Ceramic capacitor and compact Inductor use )

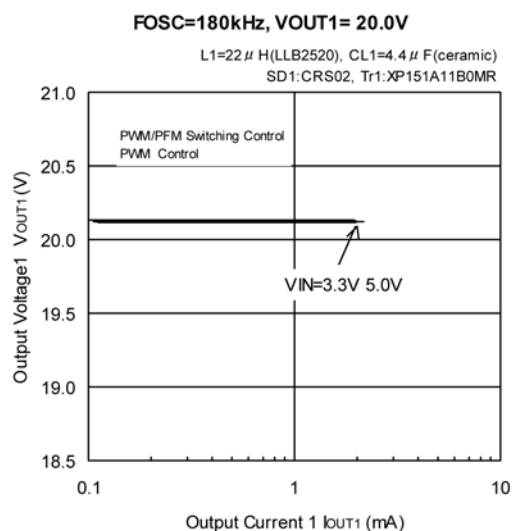
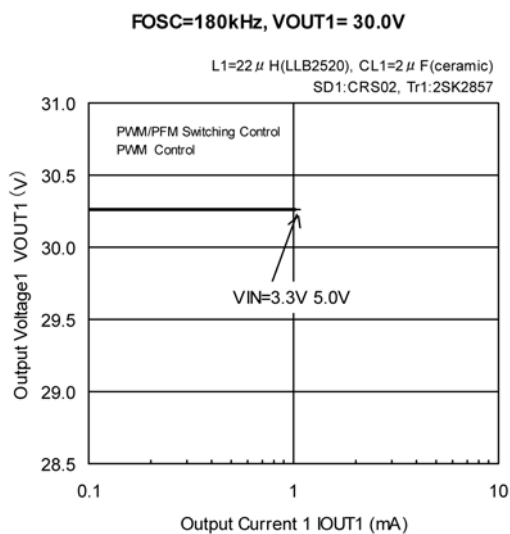
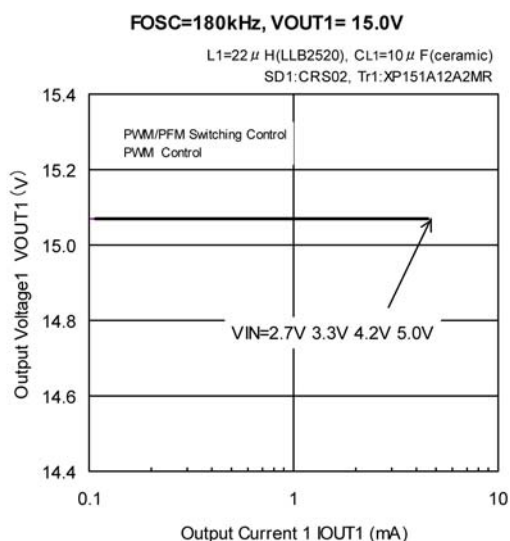
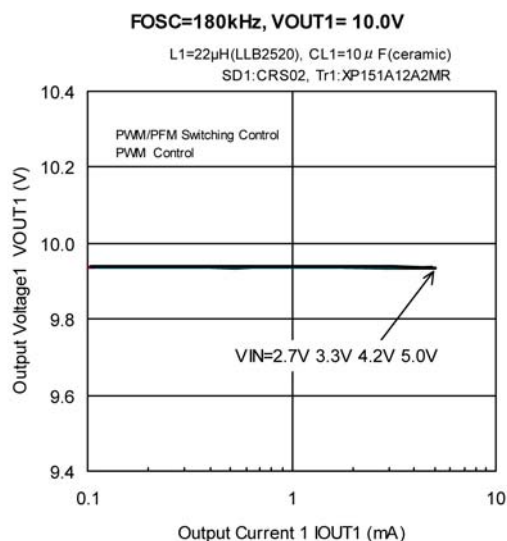

## TYPICAL PERFORMANCE CHARACTERISTICS (Continued)

< 1 ch. Step-Up DC/DC Controller > (Continued)

(1) Output Voltage vs. Output Current (Continued)

(Ceramic capacitor use)

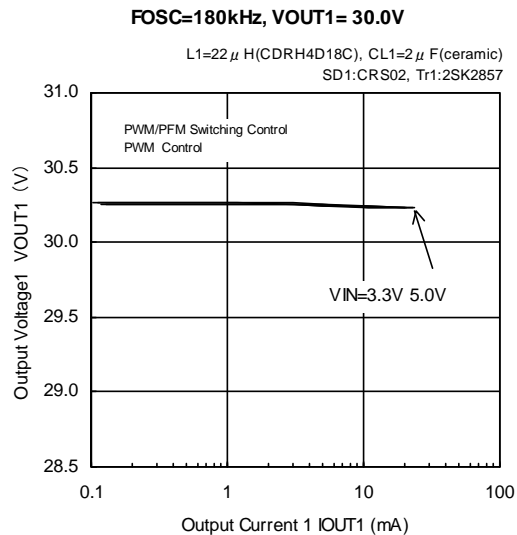
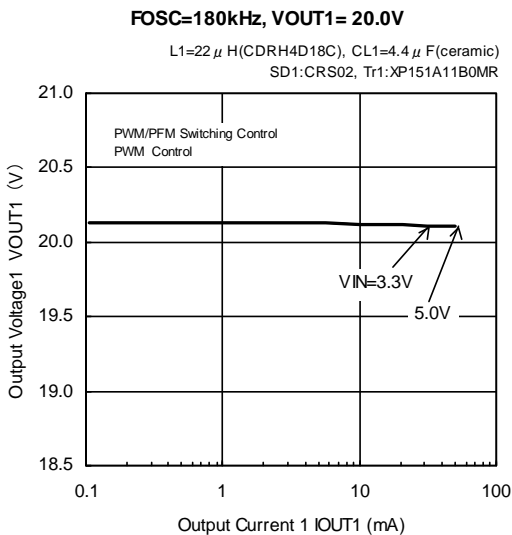
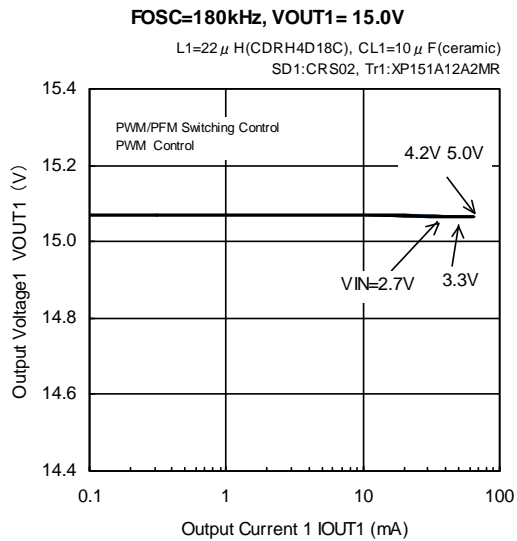
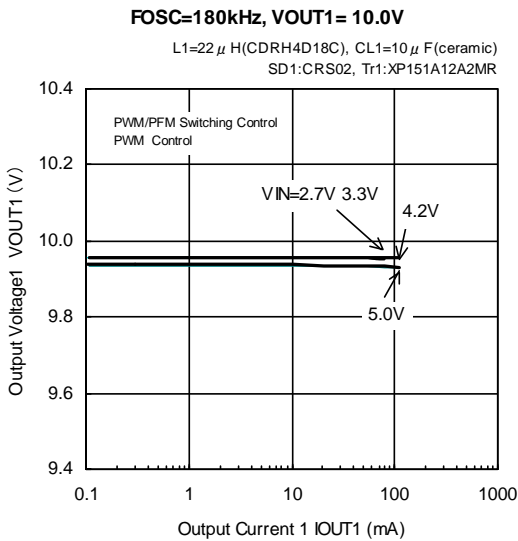
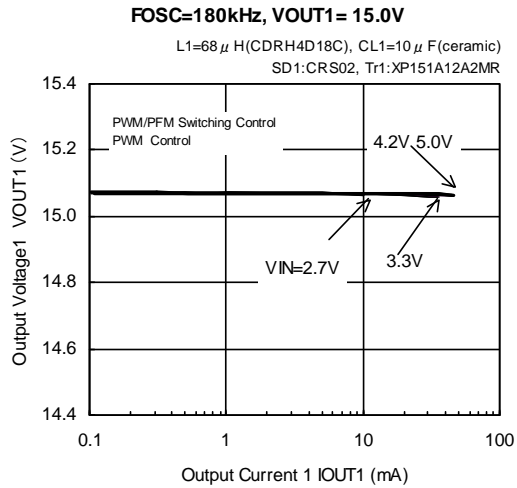
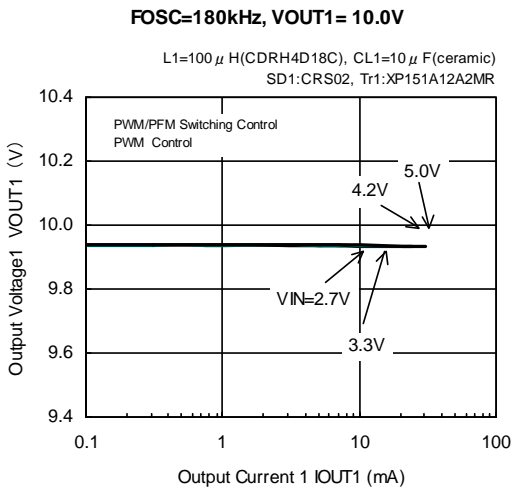



# ■ TYPICAL PERFORMANCE CHARACTERISTICS (Continued)

< 1 ch. Step-Up DC/DC Controller > (Continued)

(1) Output Voltage vs. Output Current (Continued)

(Tantalum capacitor use)

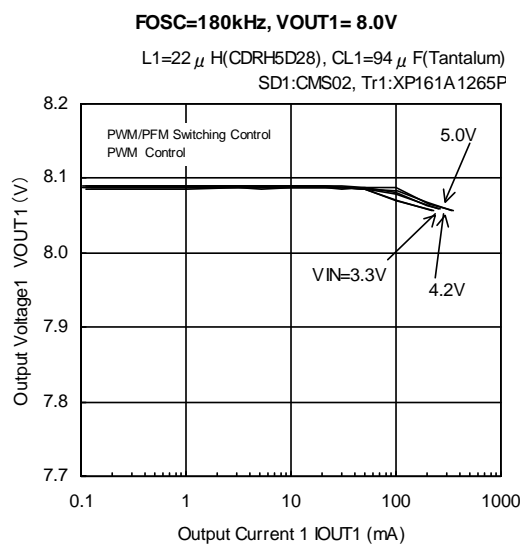
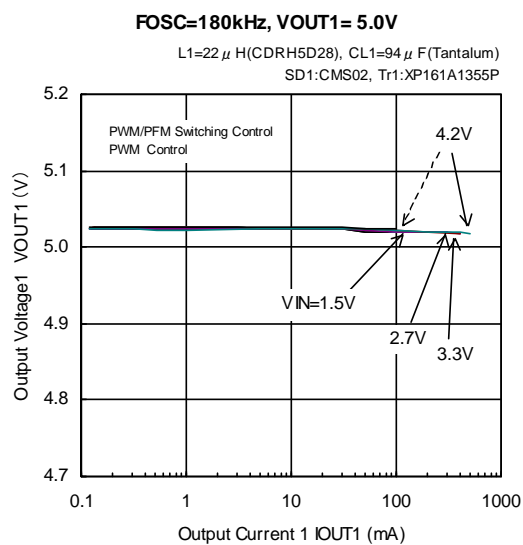
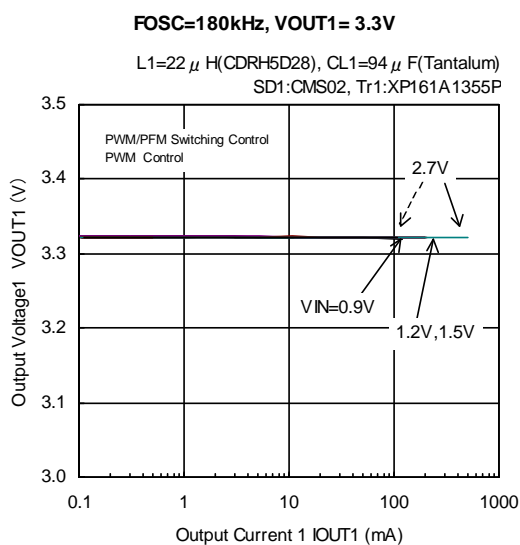
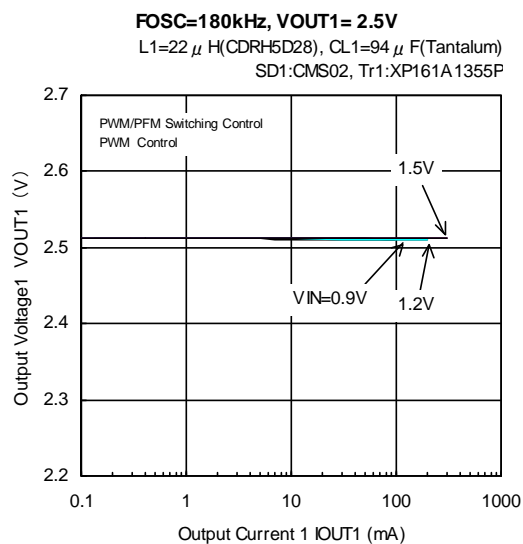
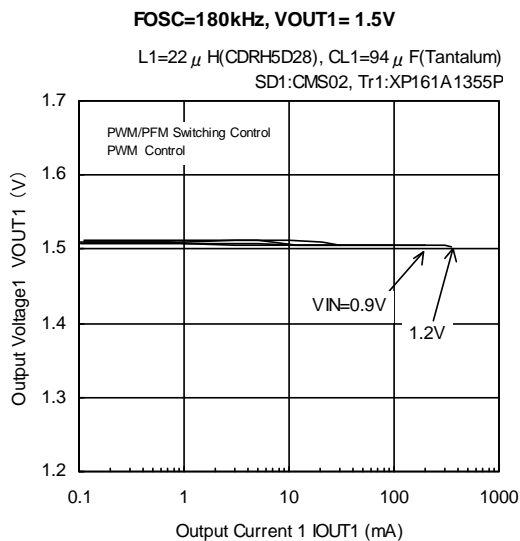

\* Dotted Arrow Head ----> PWM/PFM Switching Control

## TYPICAL PERFORMANCE CHARACTERISTICS (Continued)

< 1 ch. Step-Up DC/DC Controller > (Continued)

(1) Output Voltage vs. Output Current (Continued)

(Tantalum capacitor use)

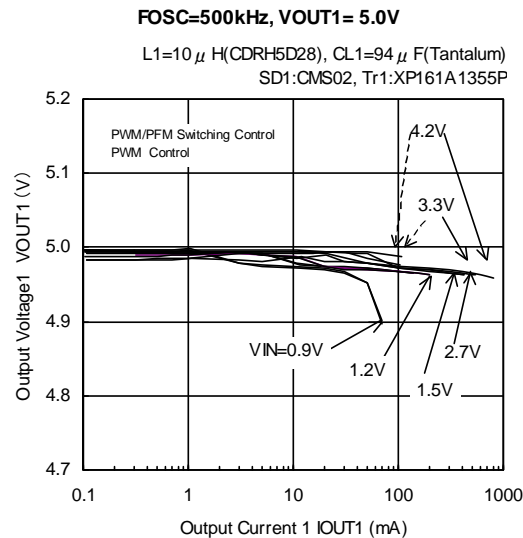
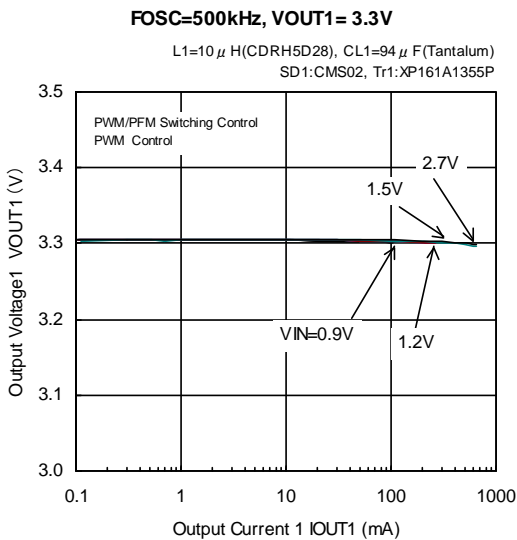
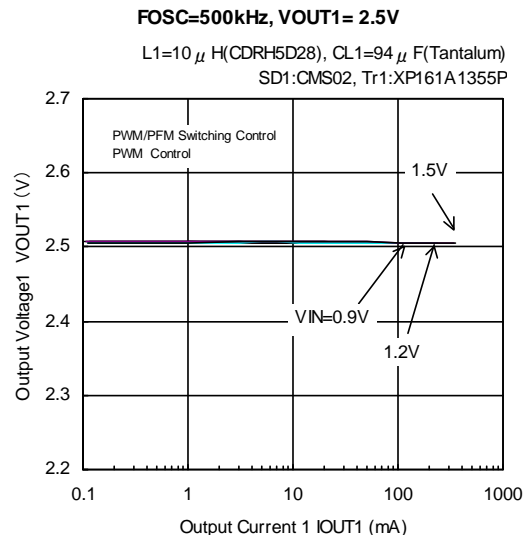
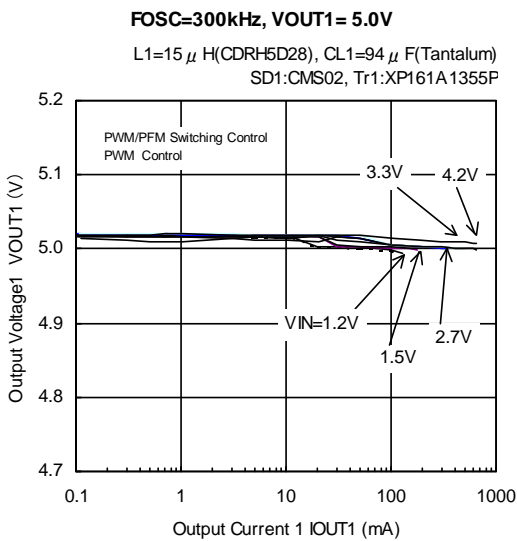
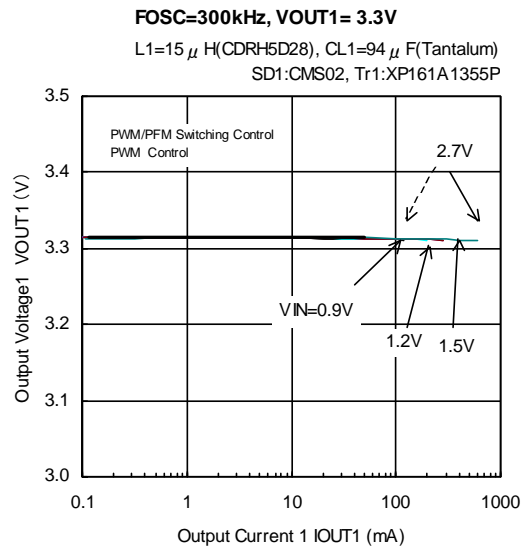
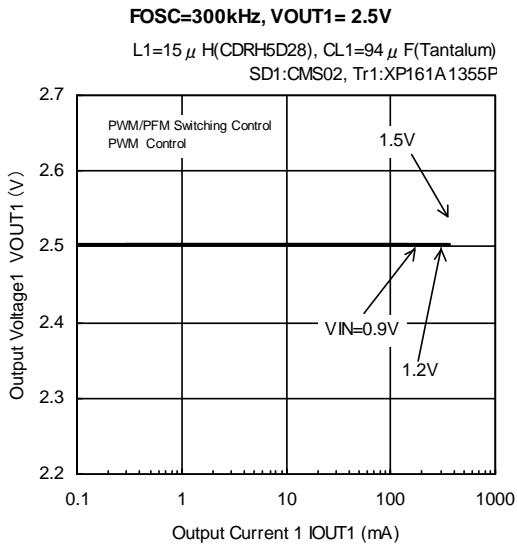

\* Dotted Arrow Head -----> PWM/PFM Switching Control

## ■ TYPICAL PERFORMANCE CHARACTERISTICS (Continued)

< 1 ch. Step-Up DC/DC Controller > (Continued)

(2) Efficiency vs. Output Current

(Ceramic capacitor and compact inductor use)

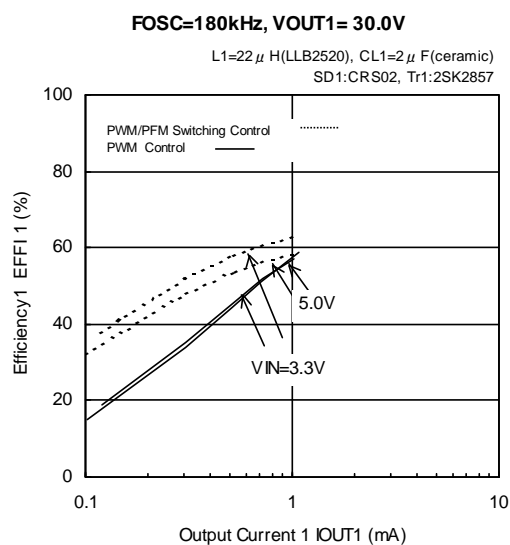
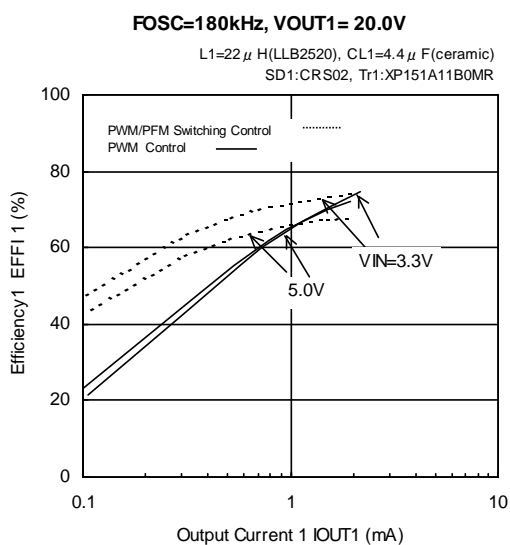
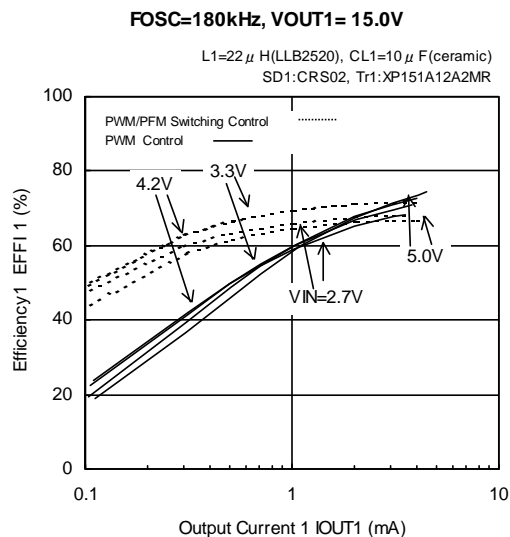
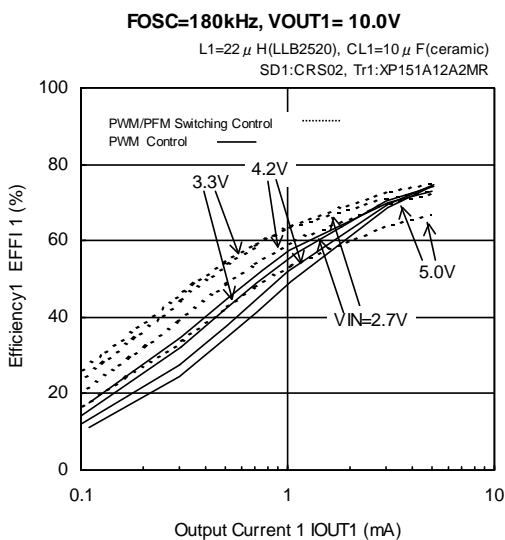

## TYPICAL PERFORMANCE CHARACTERISTICS (Continued)

< 1 ch. Step-Up DC/DC Controller > (Continued)

(2) Efficiency vs. Output Current (Continued)

(Ceramic capacitor use)

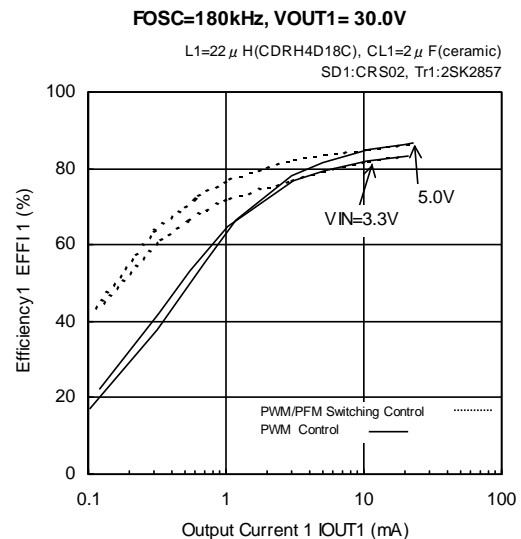
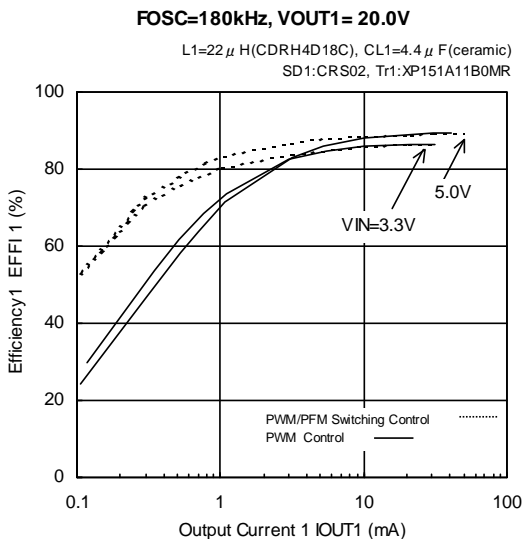
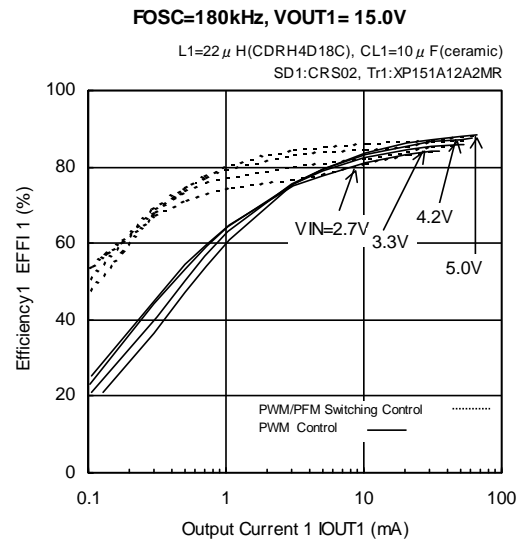
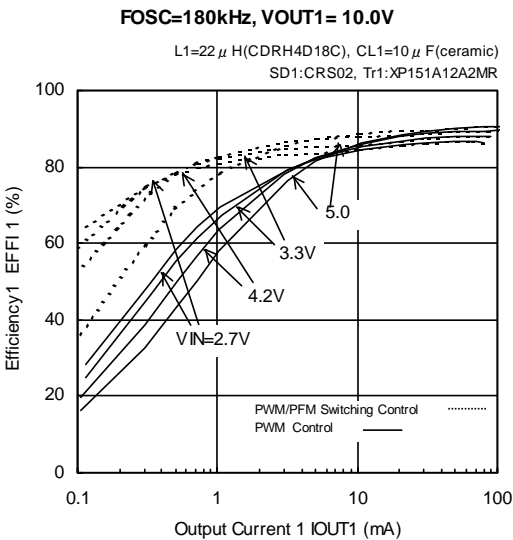
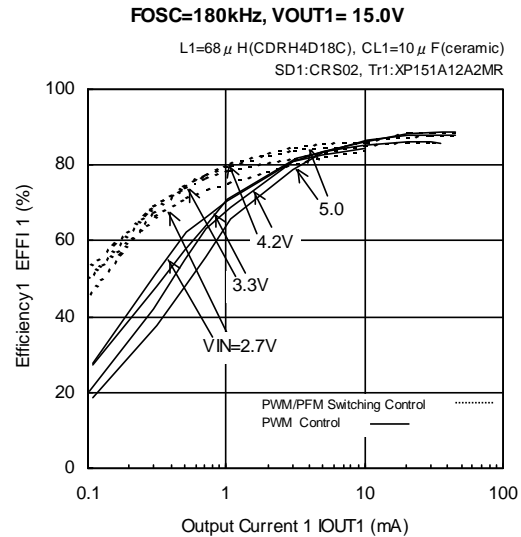
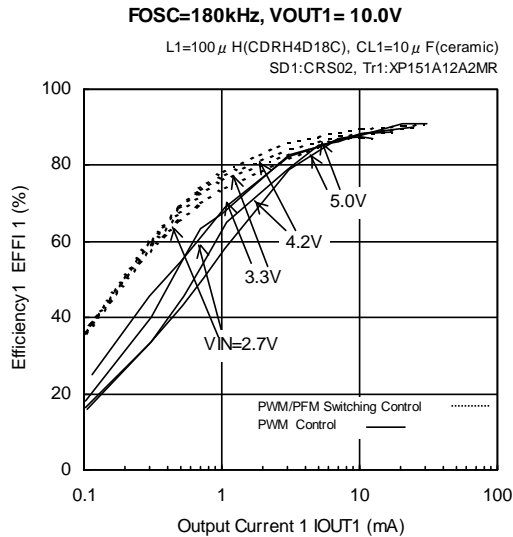

## ■ TYPICAL PERFORMANCE CHARACTERISTICS (Continued)

< 1 ch. Step-Up DC/DC Controller > (Continued)

(2) Efficiency vs. Output Current (Continued)

(Tantalum capacitor use)

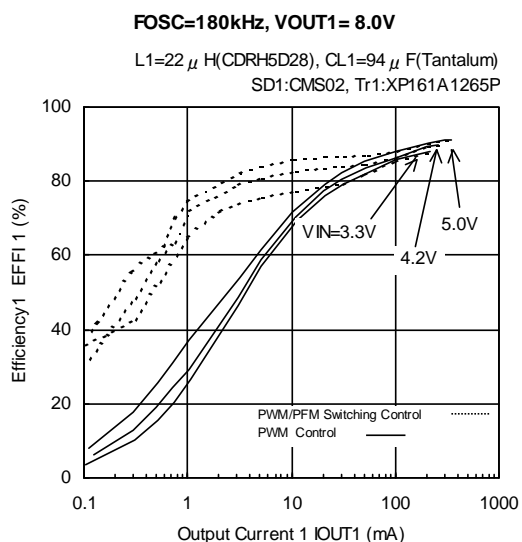
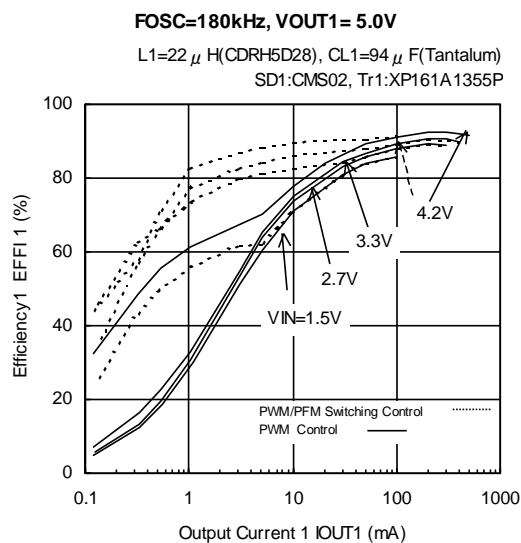
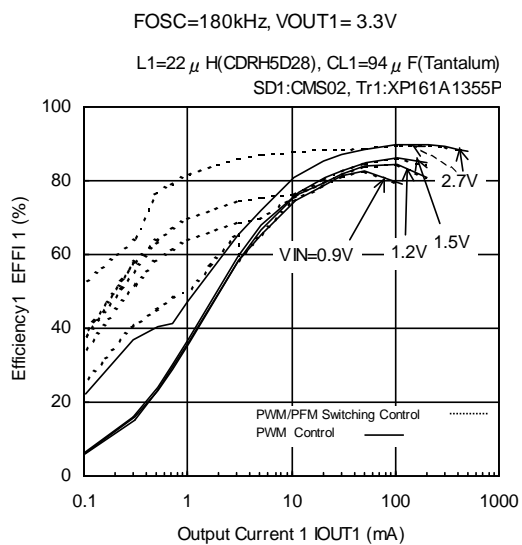
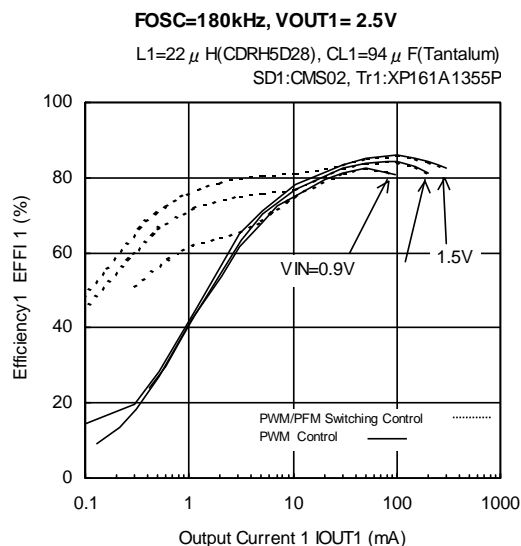
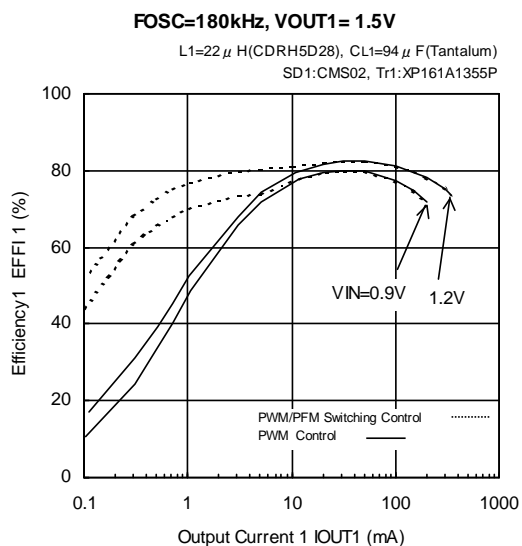

\* Dotted Arrow Head -----> PWM/PFM Switching Control

## TYPICAL PERFORMANCE CHARACTERISTICS (Continued)

< 1 ch. Step-Up DC/DC Controller > (Continued)

(2) Efficiency vs. Output Current (Continued)

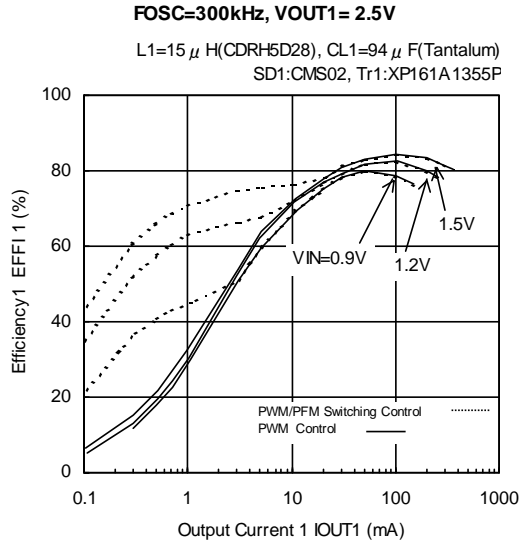

(Tantalum capacitor use)

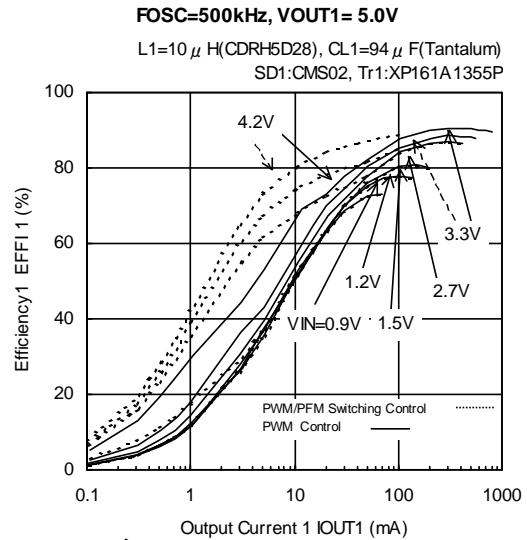
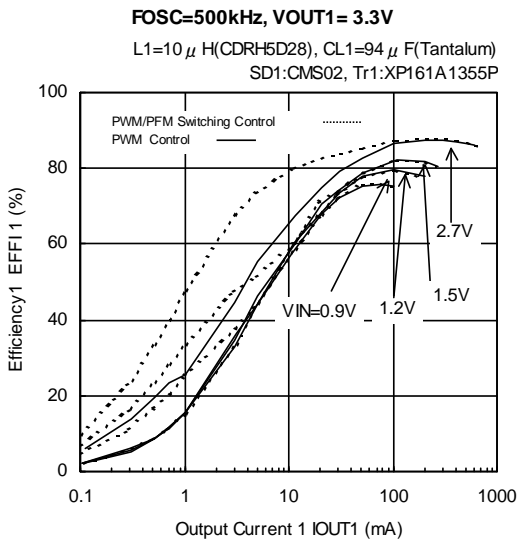
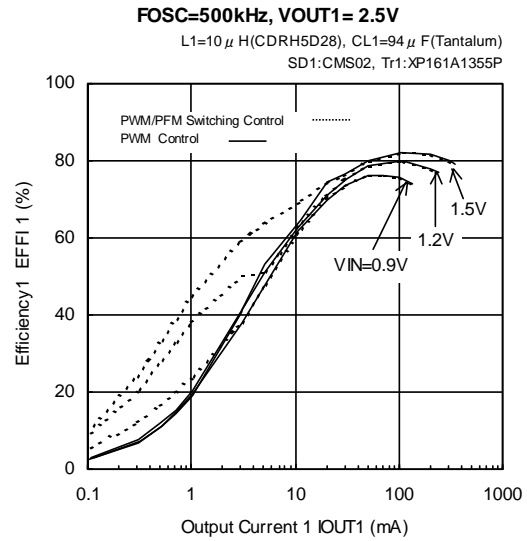
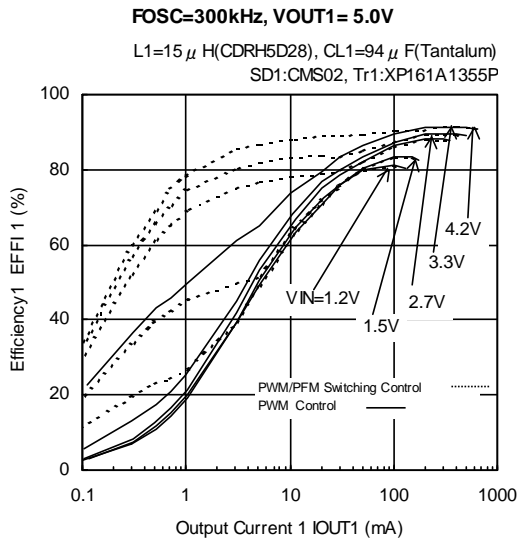
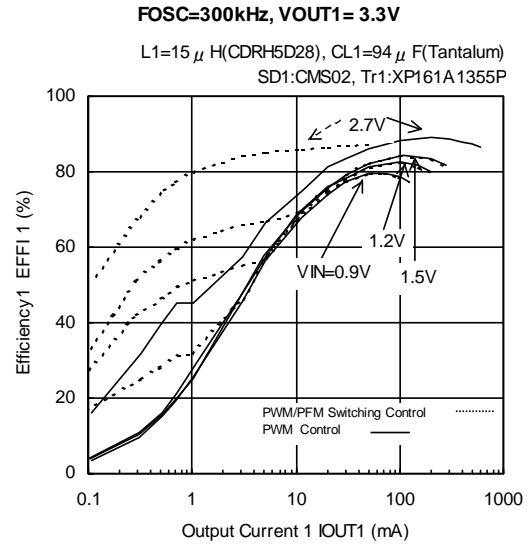

\* Dotted Arrow Head -----> PWM/PFM Switching Control

## ■ TYPICAL PERFORMANCE CHARACTERISTICS (Continued)

< 1 ch. Step-Up DC/DC Controller > (Continued)

(3) Ripple Voltage vs. Output Current

(Ceramic capacitor and compact inductor use)

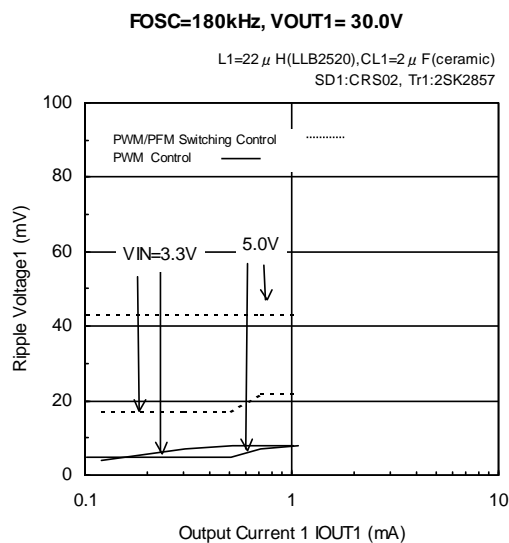
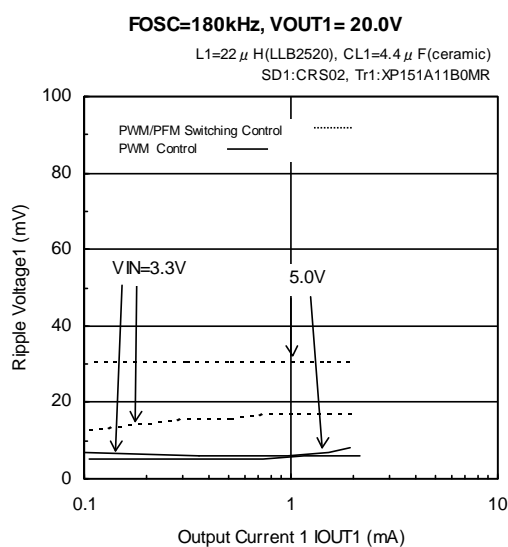
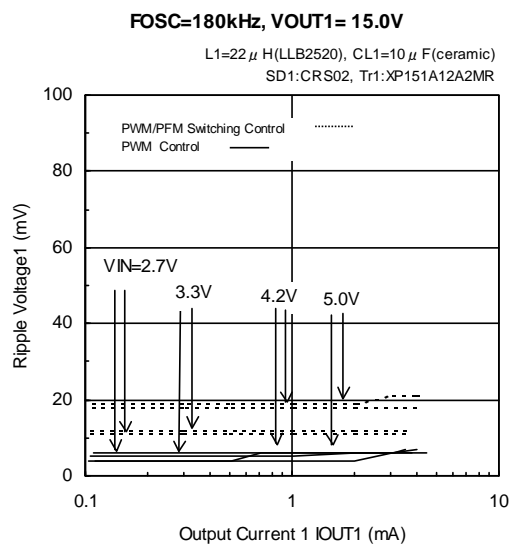
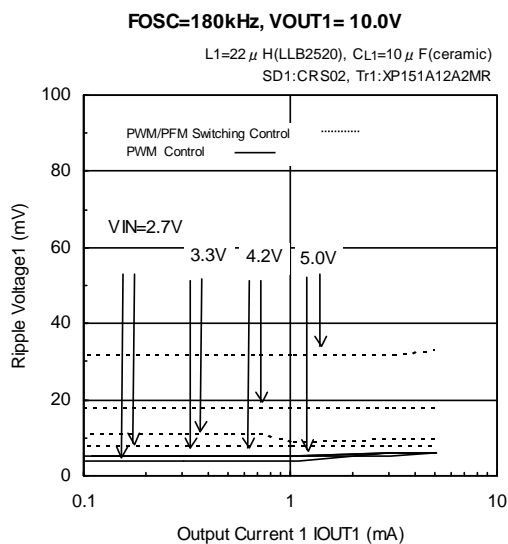

## TYPICAL PERFORMANCE CHARACTERISTICS (Continued)

< 1 ch. Step-Up DC/DC Controller > (Continued)

(3) Ripple Voltage vs. Output Current (Continued)

(Ceramic capacitor use)

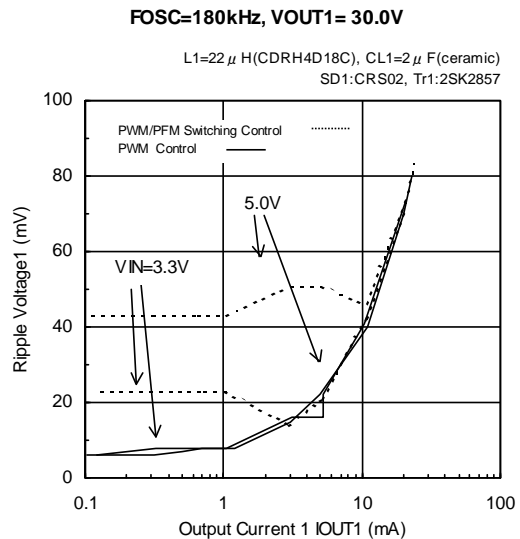
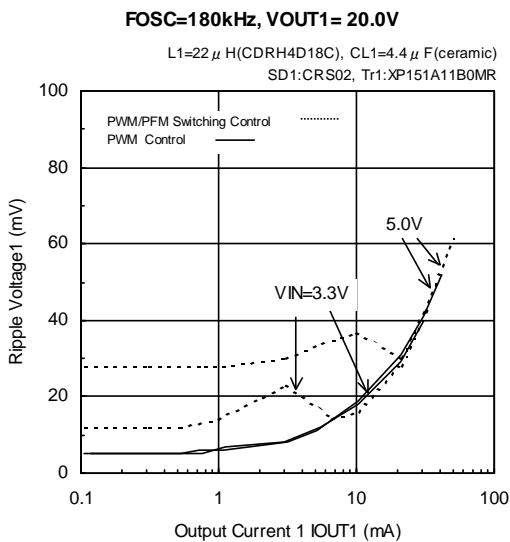
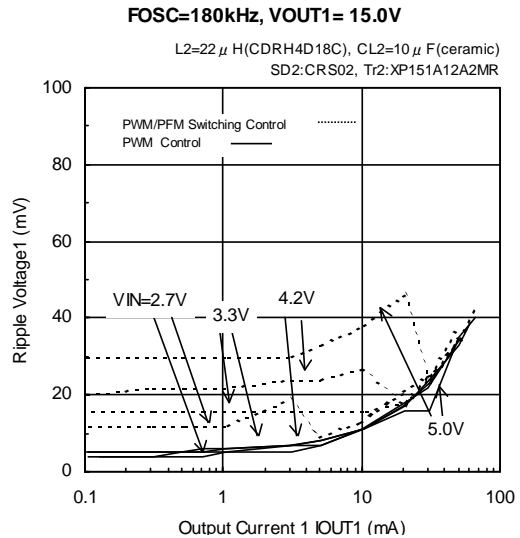
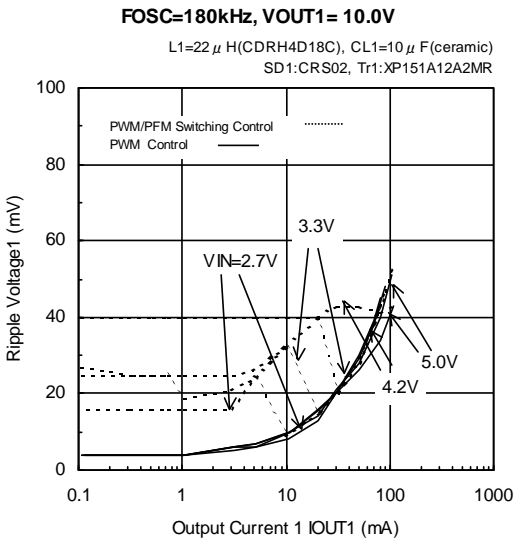
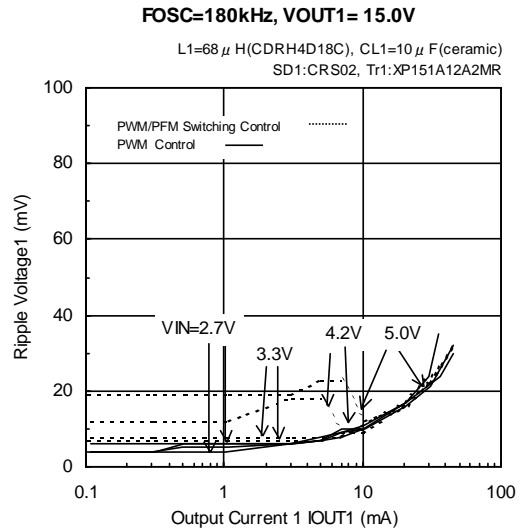
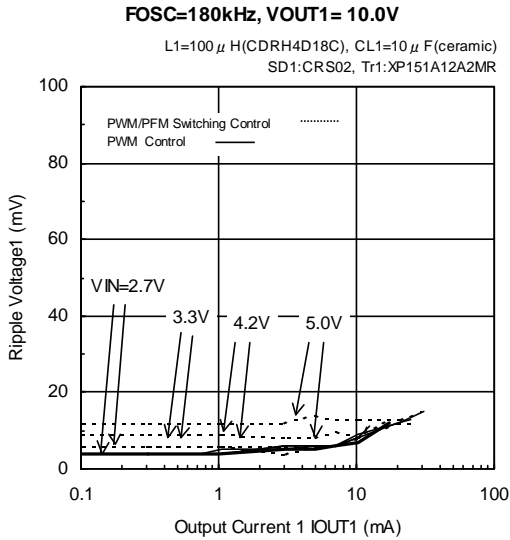



## TYPICAL PERFORMANCE CHARACTERISTICS (Continued)

< 1 ch. Step-Up DC/DC Controller > (Continued)

(3) Ripple Voltage vs. Output Current (Continued)

(Tantalum capacitor use)

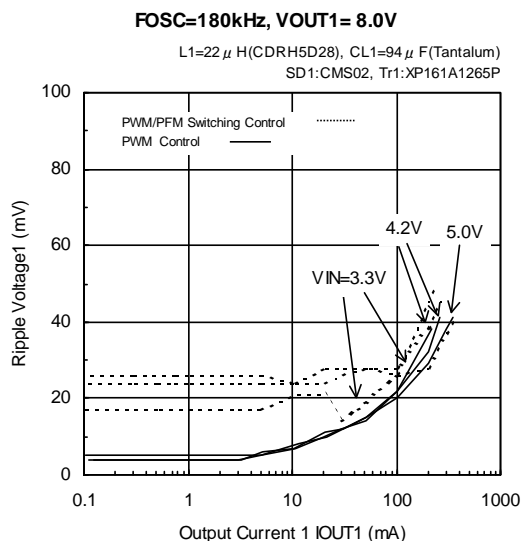
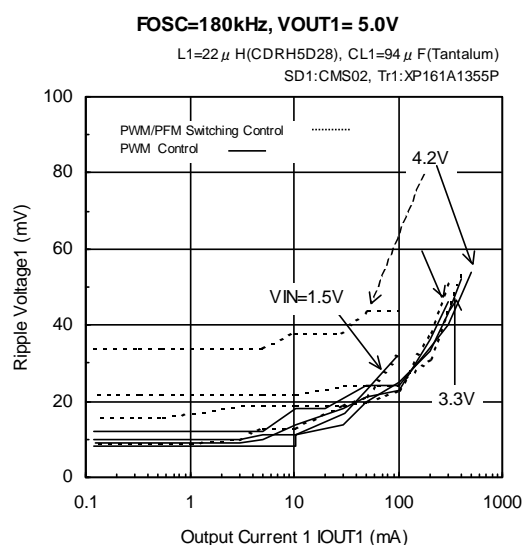
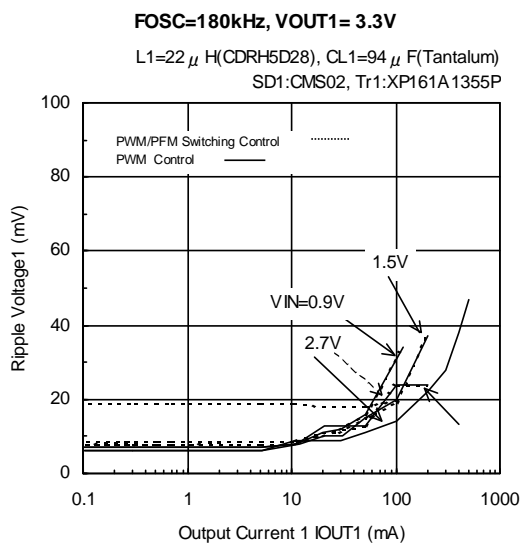
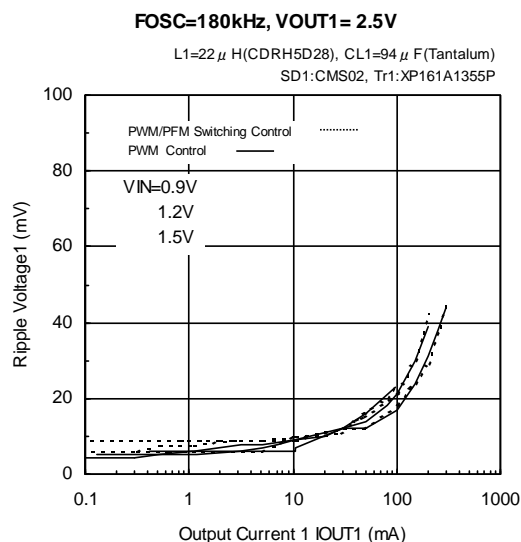
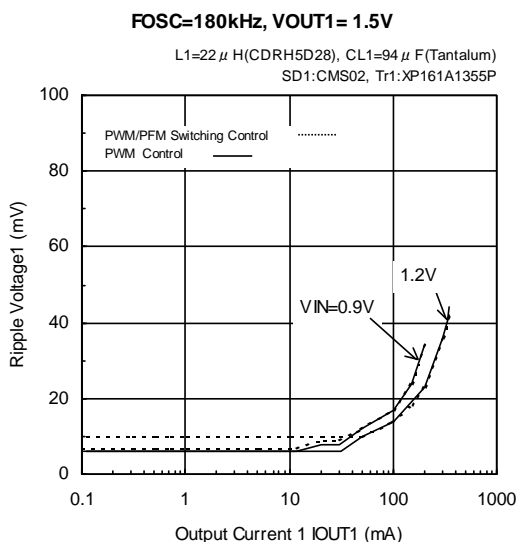

\* Dotted Arrow Head -----> PWM/PFM Switching Control

## TYPICAL PERFORMANCE CHARACTERISTICS (Continued)

< 1 ch. Step-Up DC/DC Controller > (Continued)

(3) Ripple Voltage vs. Output Current (Continued)

(Tantalum capacitor use)

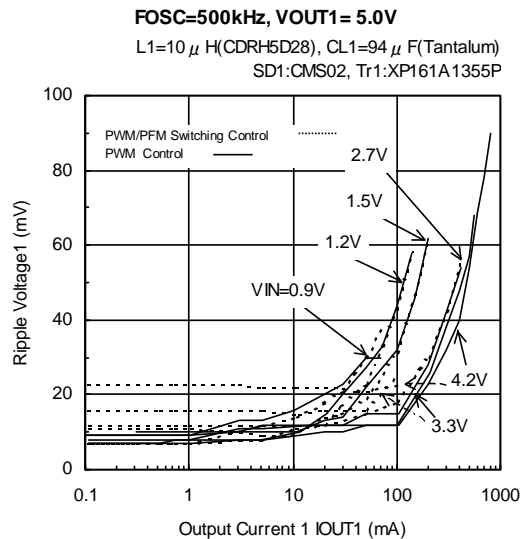
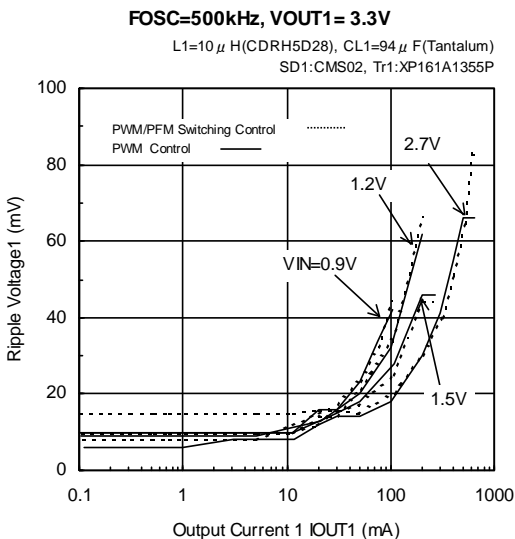
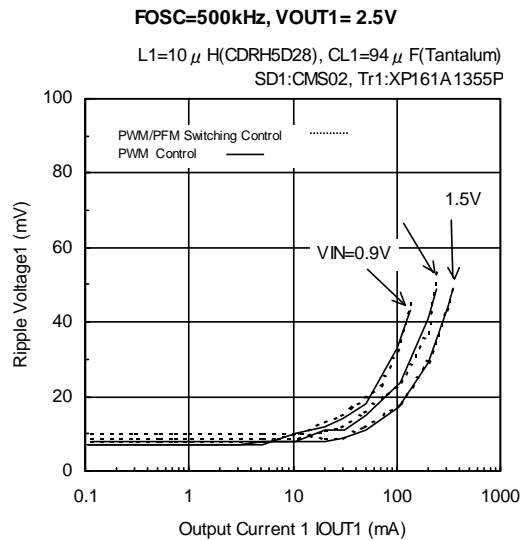
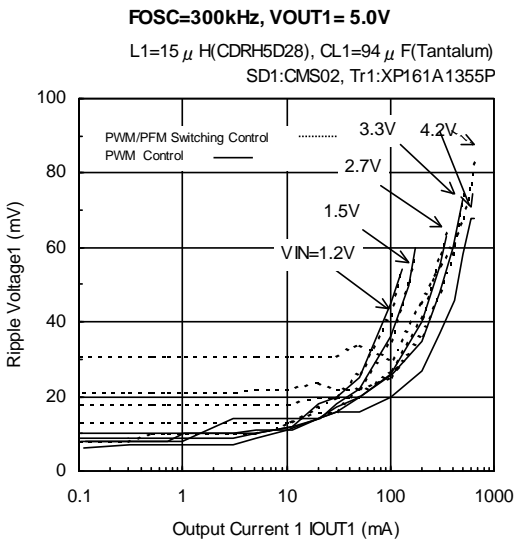
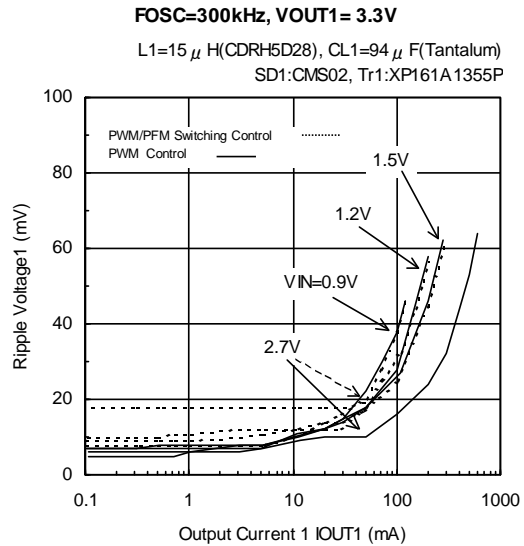
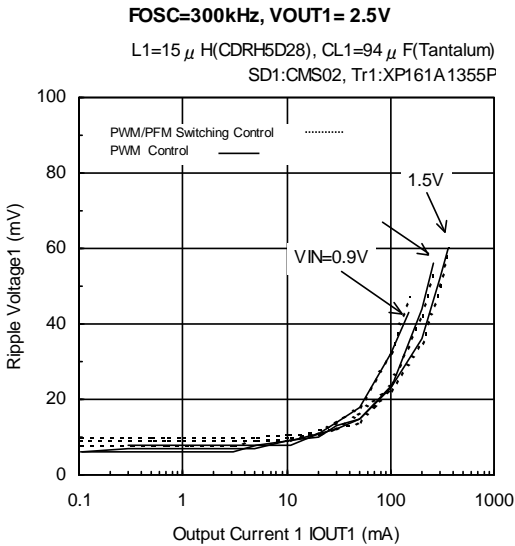

\* Dotted Arrow Head -----> PWM/PFM Switching Control

## ■ TYPICAL PERFORMANCE CHARACTERISTICS (Continued)

< 2 ch. Inverting DC/DC Controller >

(4) Output Voltage vs. Output Current

(Ceramic capacitor and compact inductor use)

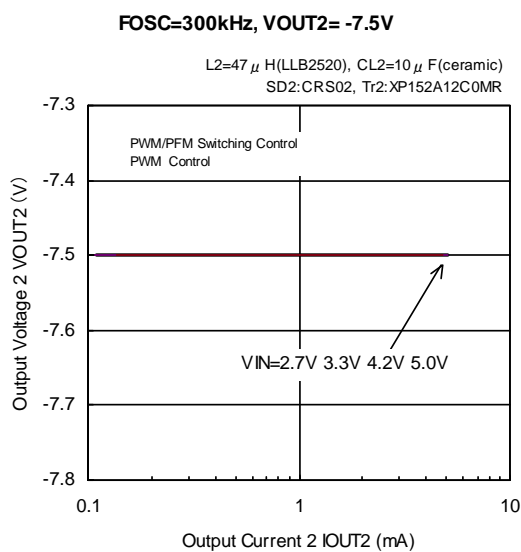
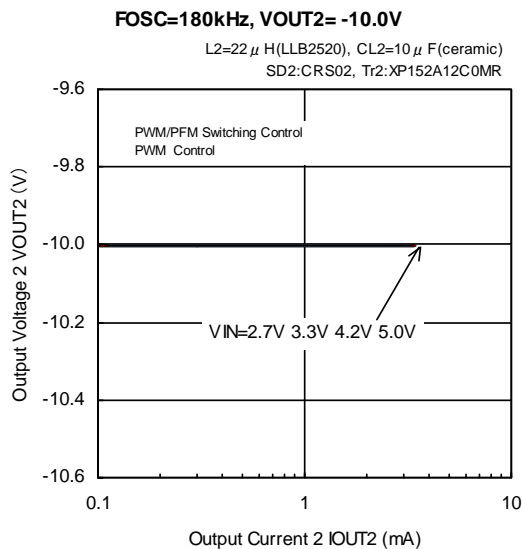
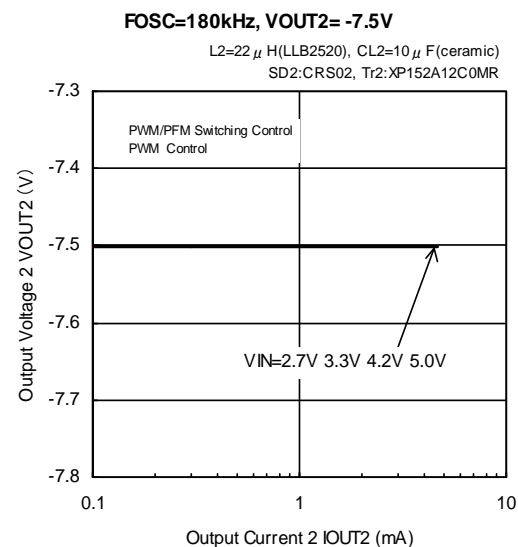

## TYPICAL PERFORMANCE CHARACTERISTICS (Continued)

< 2 ch. Inverting DC/DC Controller > (Continued)

(4) Output Voltage vs. Output Current (Continued)

(Ceramic capacitor use)

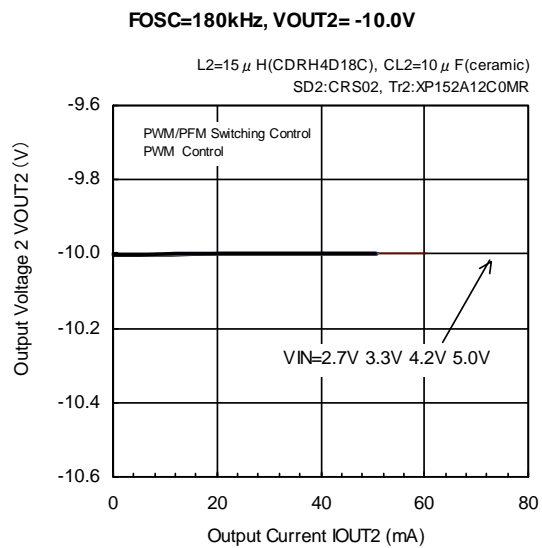
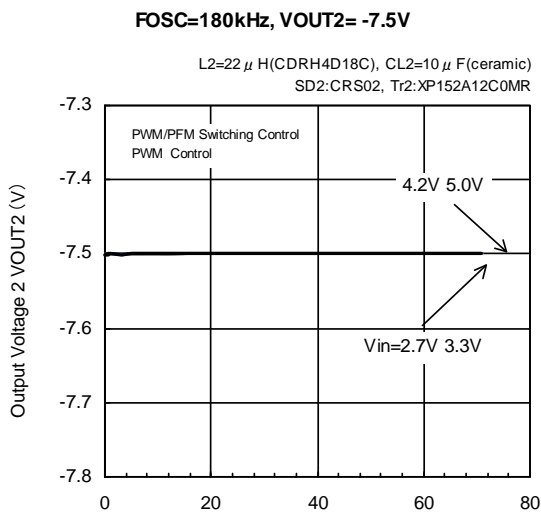
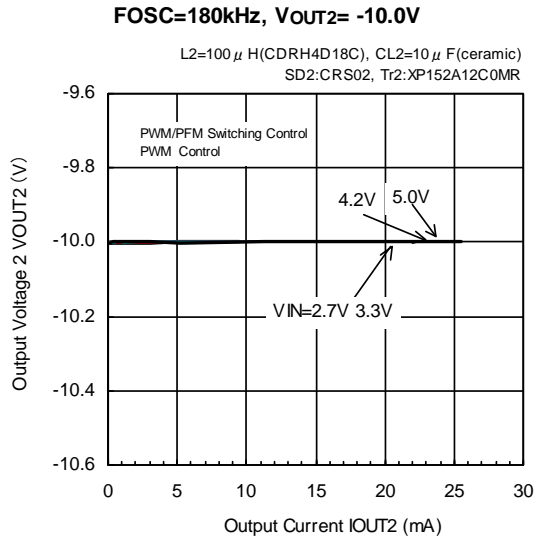
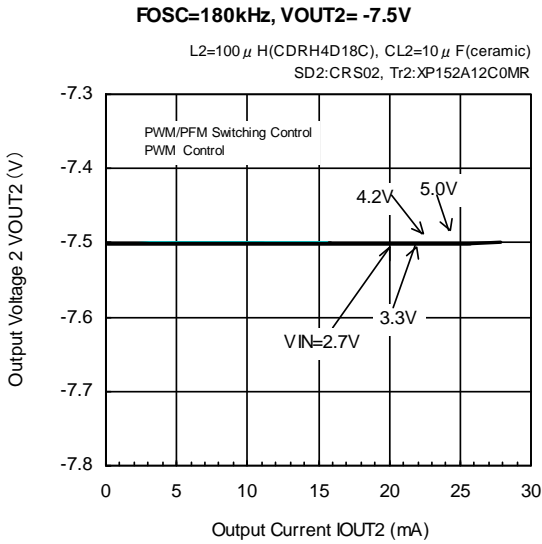

## ■ TYPICAL PERFORMANCE CHARACTERISTICS (Continued)

< 2 ch. Inverting DC/DC Controller > (Continued)

(4) Output Voltage vs. Output Current (Continued)

(Tantalum capacitor use)

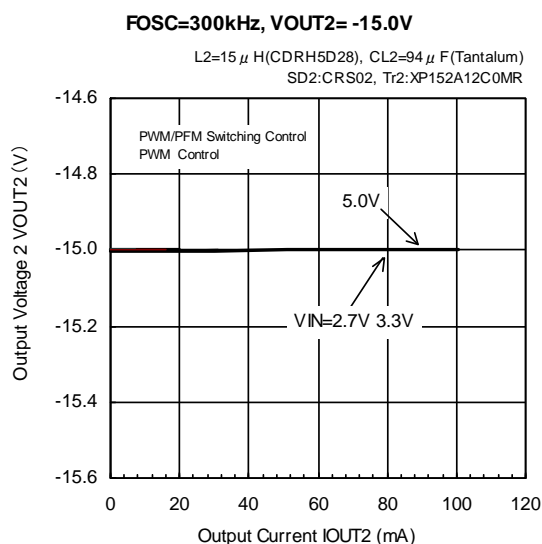
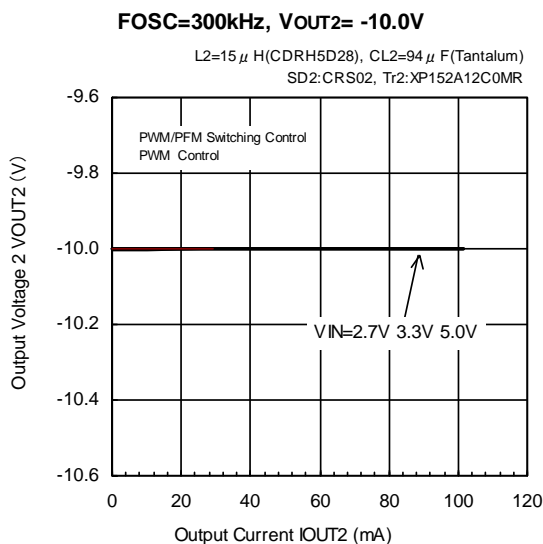
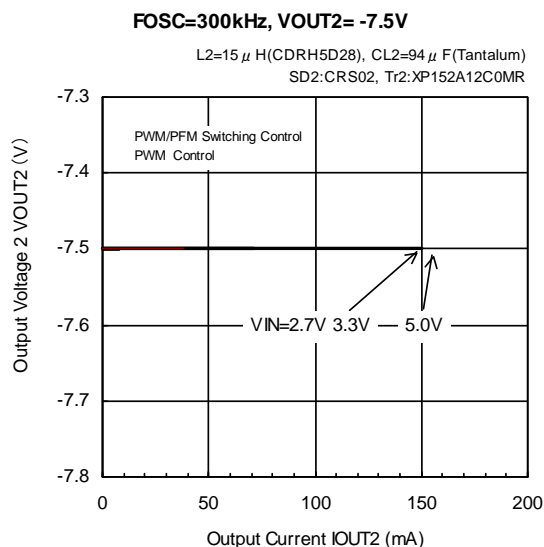
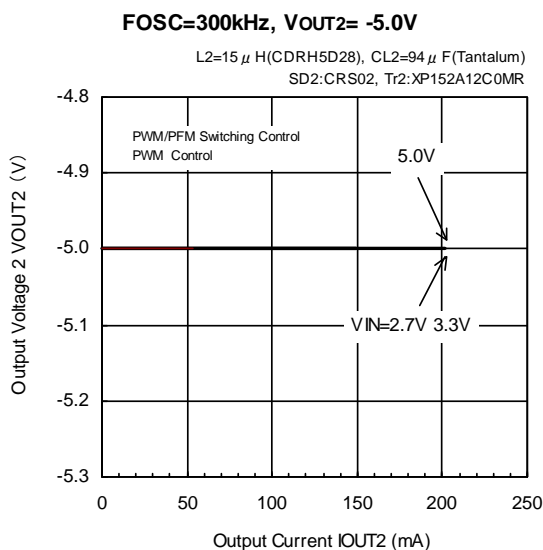
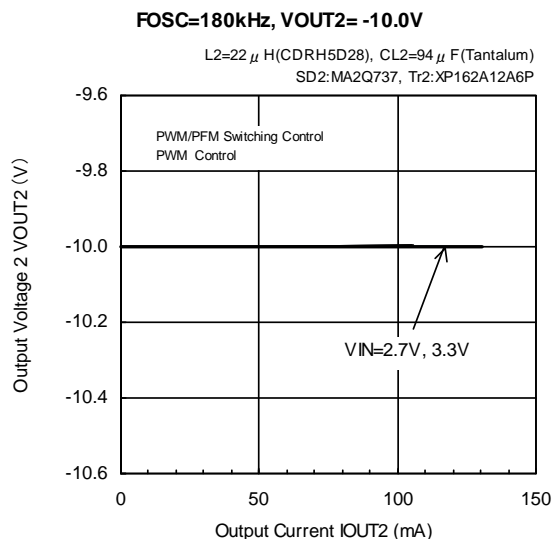
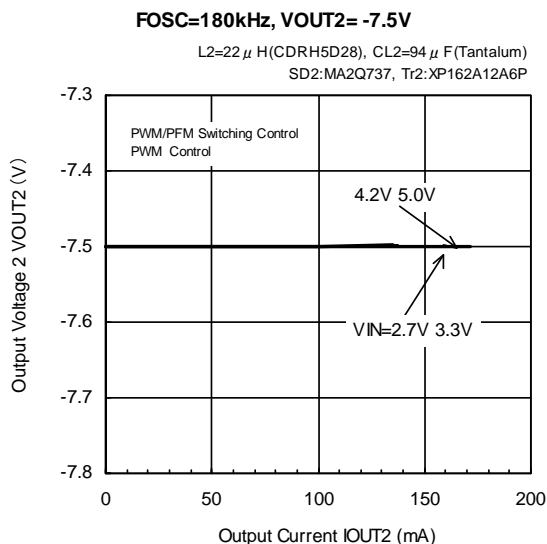

## TYPICAL PERFORMANCE CHARACTERISTICS (Continued)

< 2 ch. Inverting DC/DC Controller > (Continued)

(5) Efficiency vs. Output Current

(Ceramic capacitor and compact inductor use)

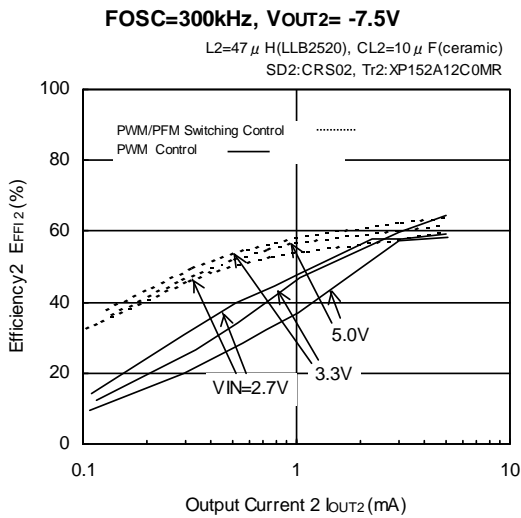
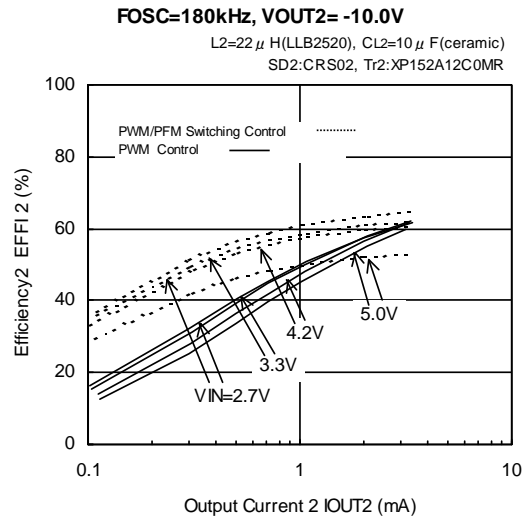
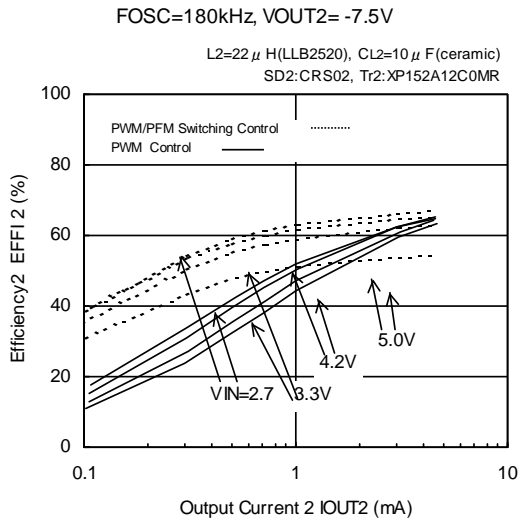

## ■ TYPICAL PERFORMANCE CHARACTERISTICS (Continued)

< 2 ch. Inverting DC/DC Controller > (Continued)

(5) Efficiency vs. Output Current (Continued)

(Ceramic capacitor use)

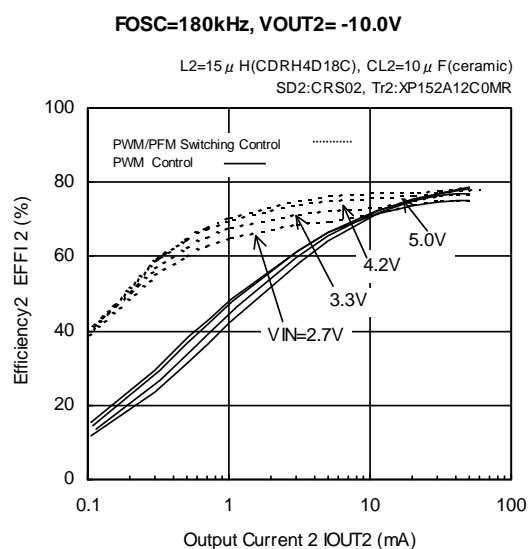
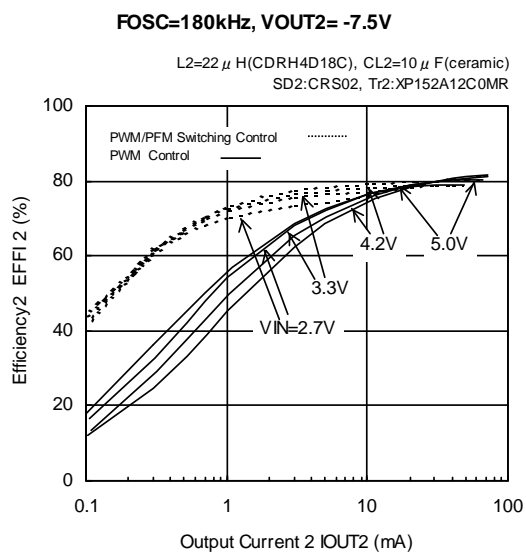
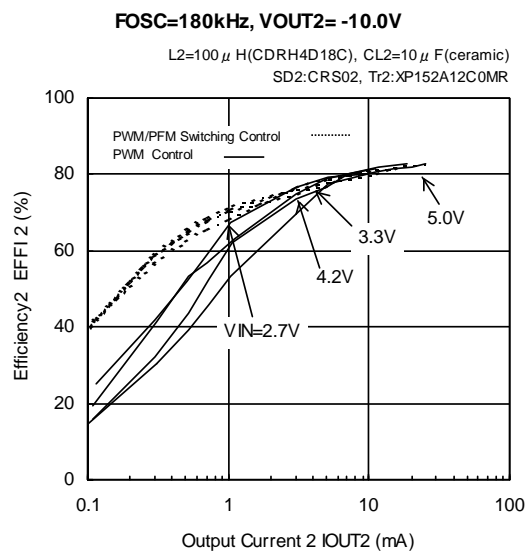
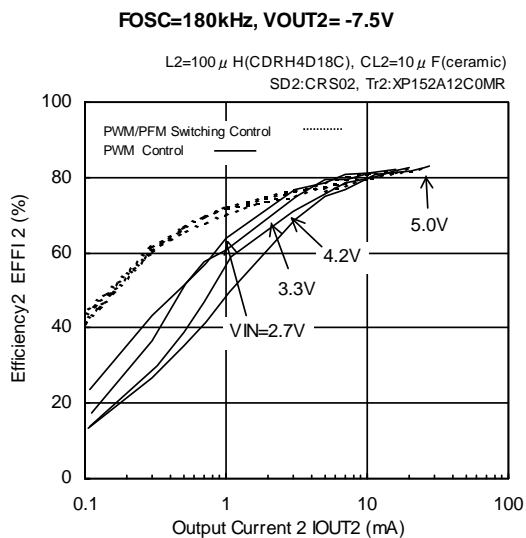

## TYPICAL PERFORMANCE CHARACTERISTICS (Continued)

< 2 ch. Inverting DC/DC Controller > (Continued)

(5) Efficiency vs. Output Current (Continued)

(Tantalum capacitor use)

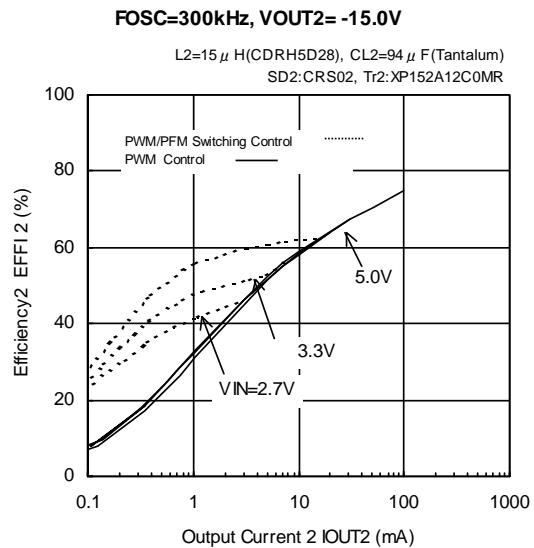
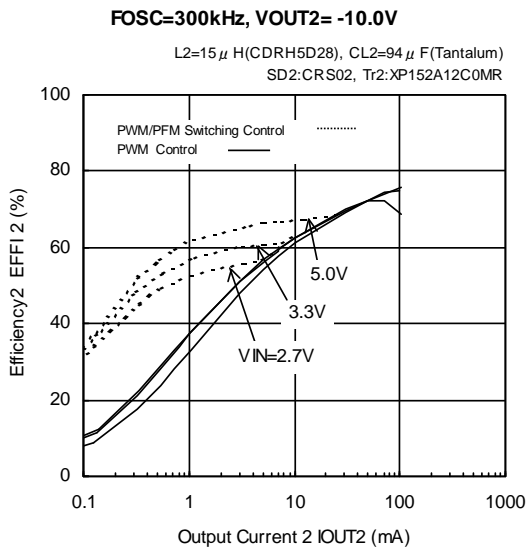
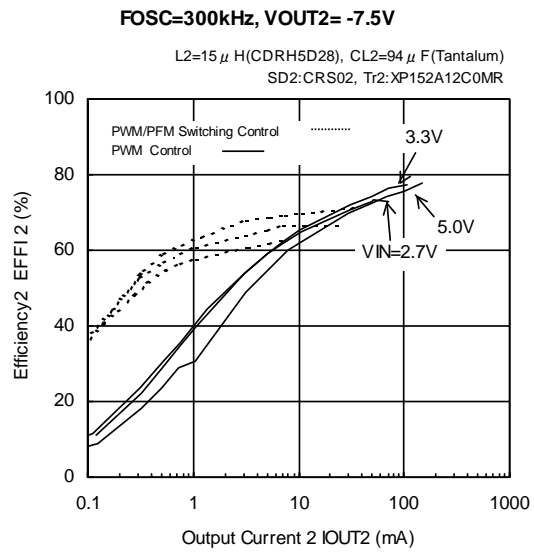
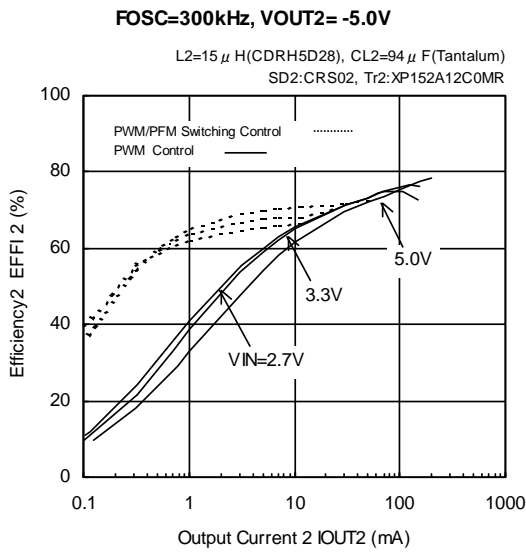
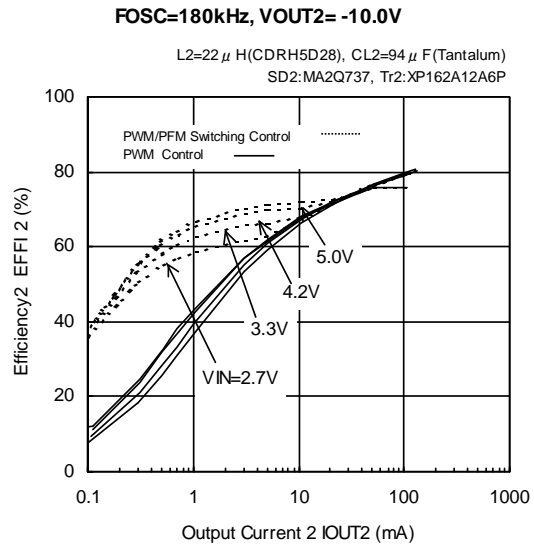
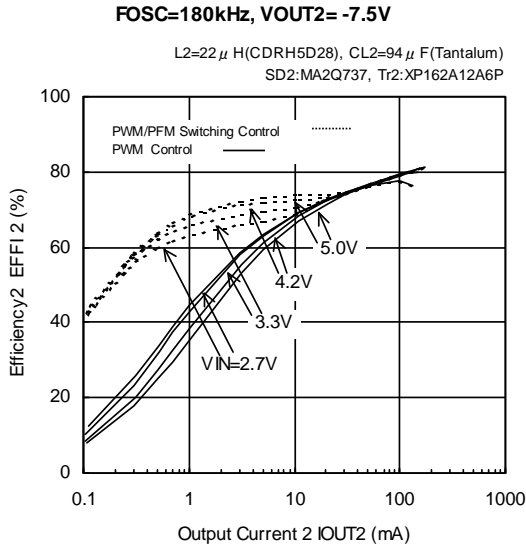



## ■ TYPICAL PERFORMANCE CHARACTERISTICS (Continued)

< 2 ch. Inverting DC/DC Controller > (Continued)

(5) Ripple Voltage vs. Output Current

(Ceramic capacitor and compact inductor use)

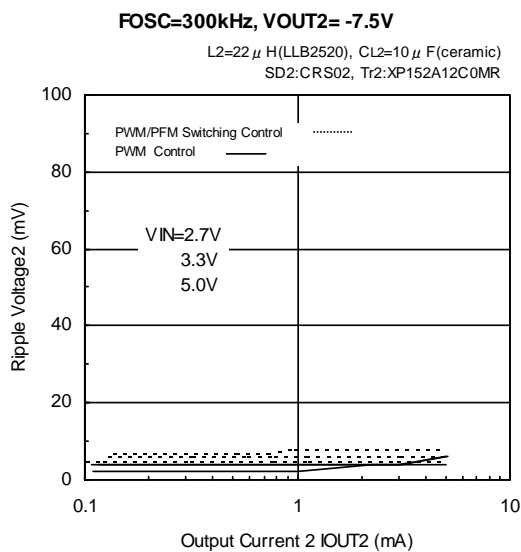
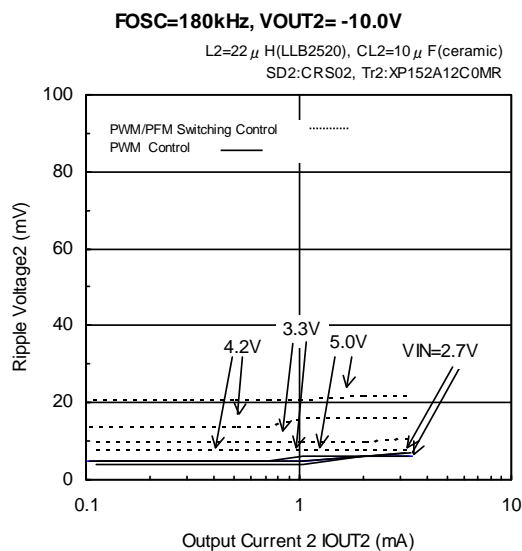
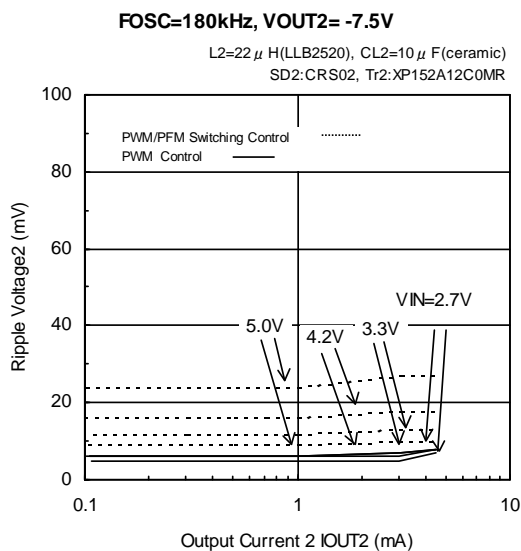

## TYPICAL PERFORMANCE CHARACTERISTICS (Continued)

< 2 ch. Inverting DC/DC Controller > (Continued)

(5) Ripple Voltage vs. Output Current (Continued)

(Ceramic capacitor use)

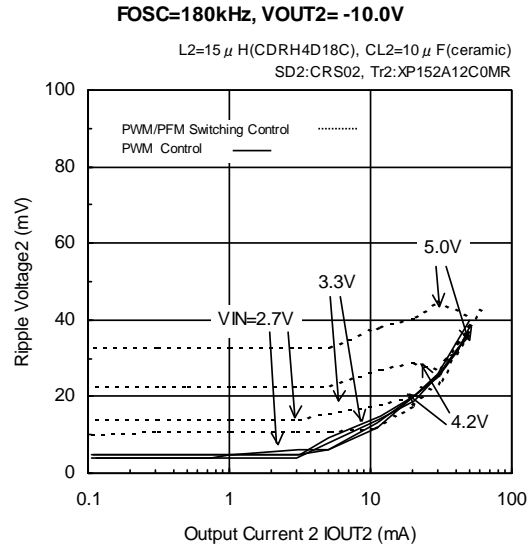
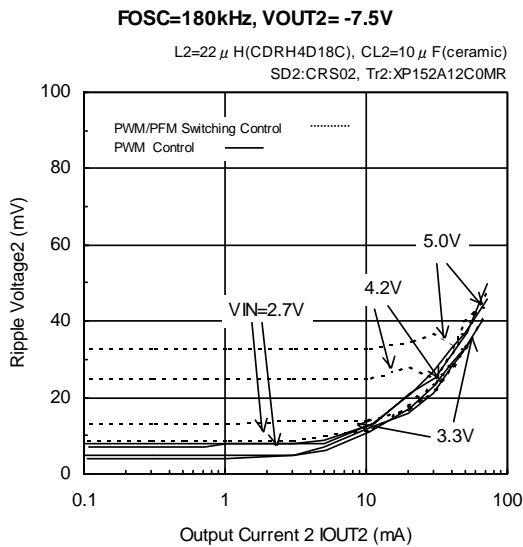
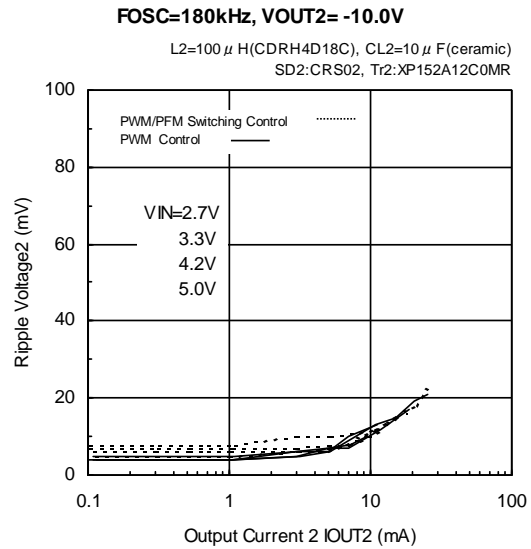
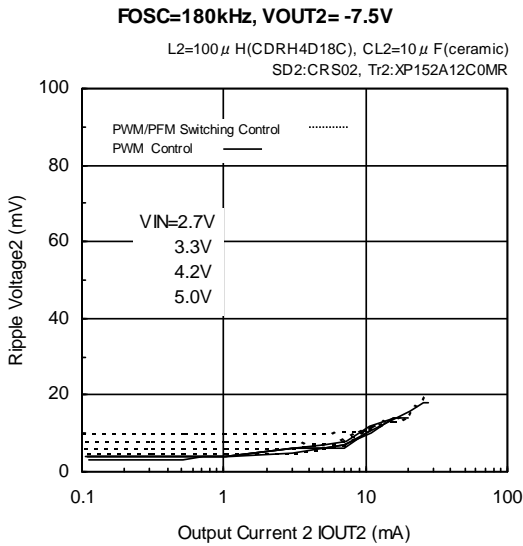

## TYPICAL PERFORMANCE CHARACTERISTICS (Continued)

< 2 ch. Inverting DC/DC Controller > (Continued)

(5) Ripple Voltage vs. Output Current (Continued)

(Tantalum capacitor use)

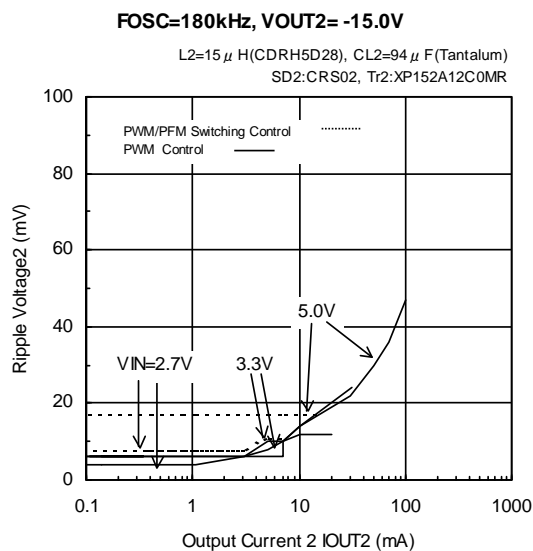
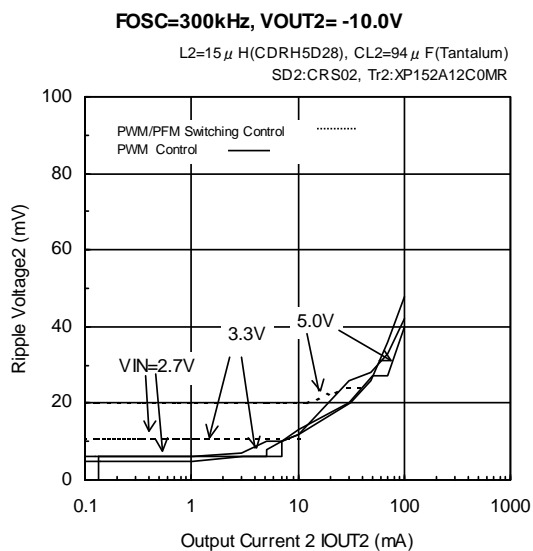
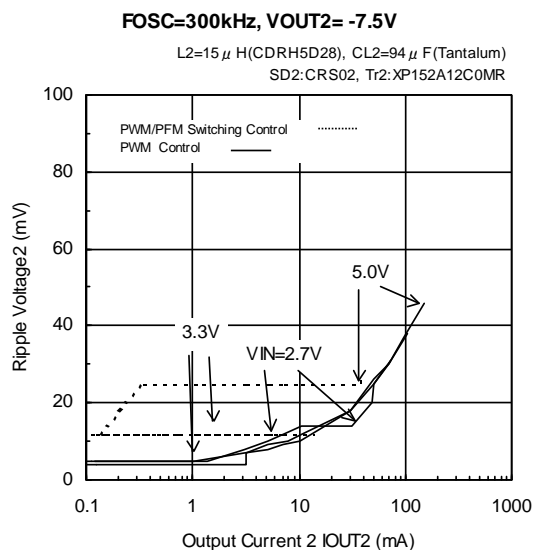
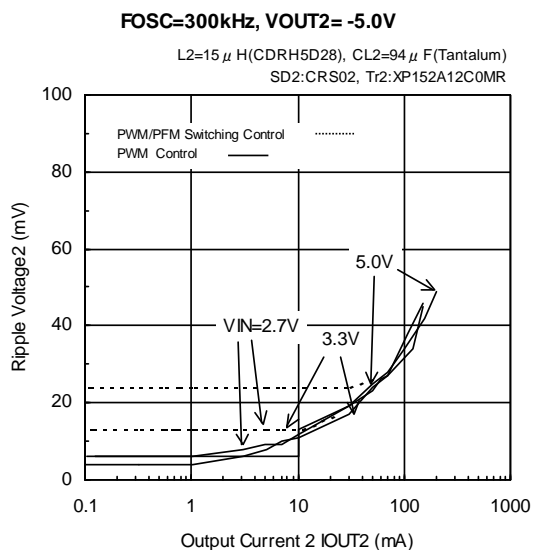
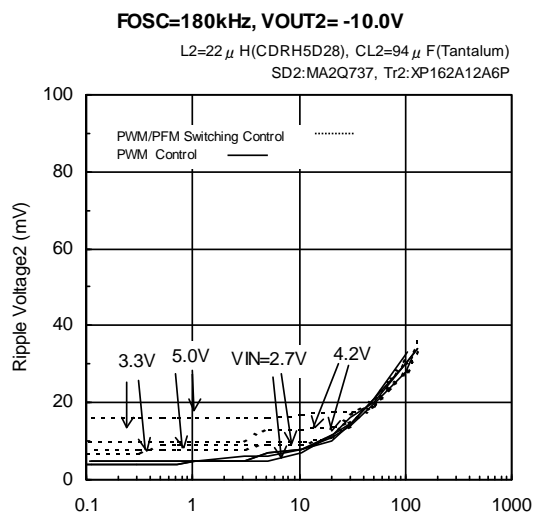
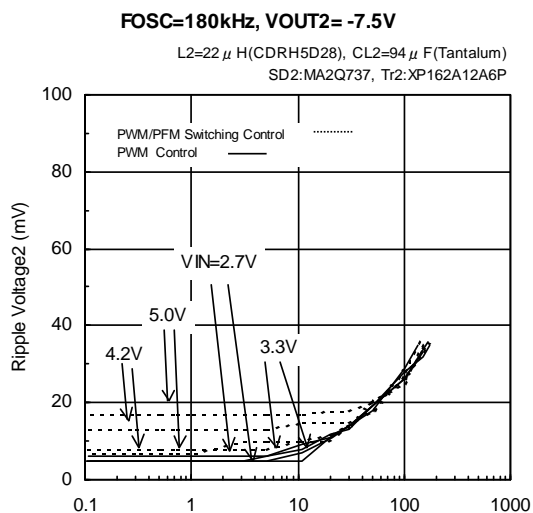

## TYPICAL PERFORMANCE CHARACTERISTICS (Continued)

< 2 ch. Inverting DC/DC Controller > (Continued)

### (6) Breakdown of Output Voltage

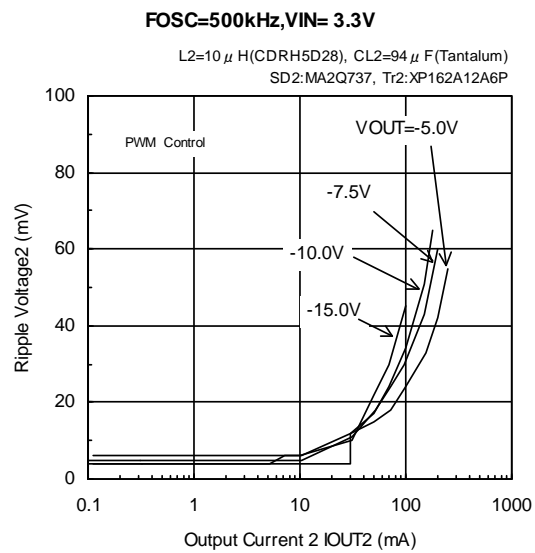
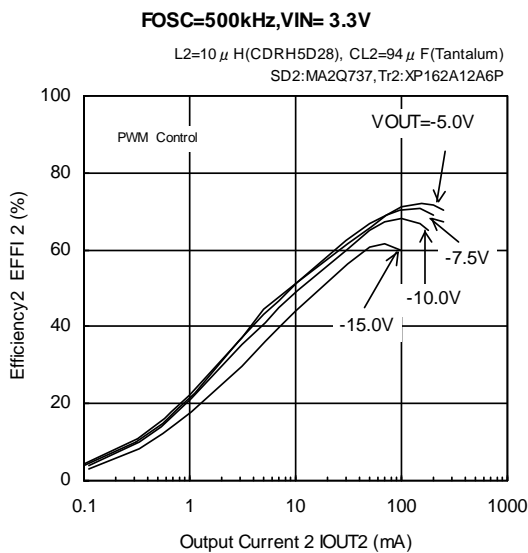
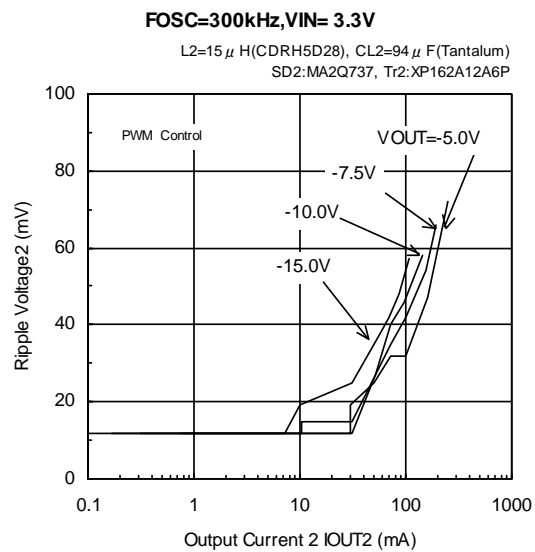
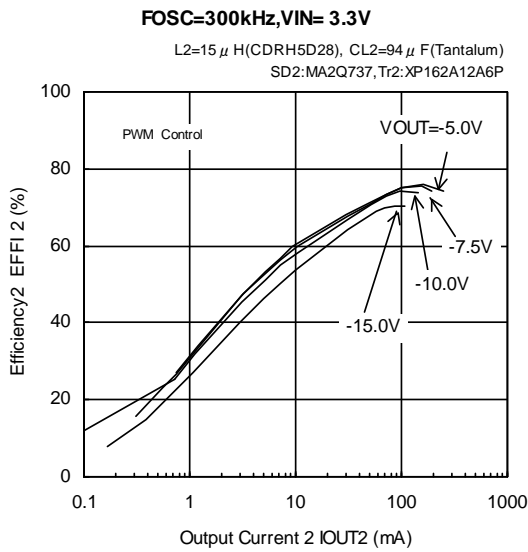
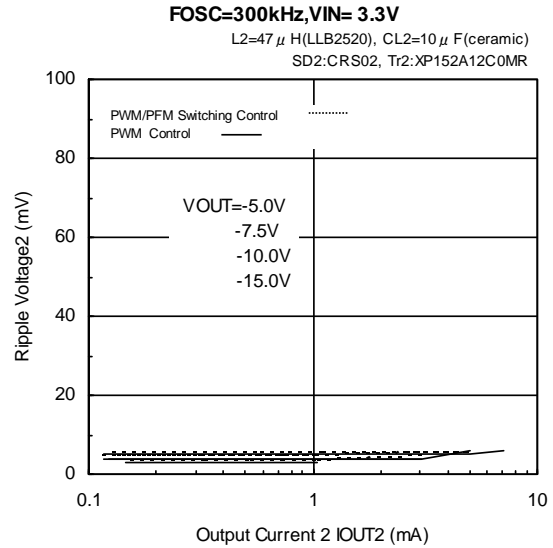
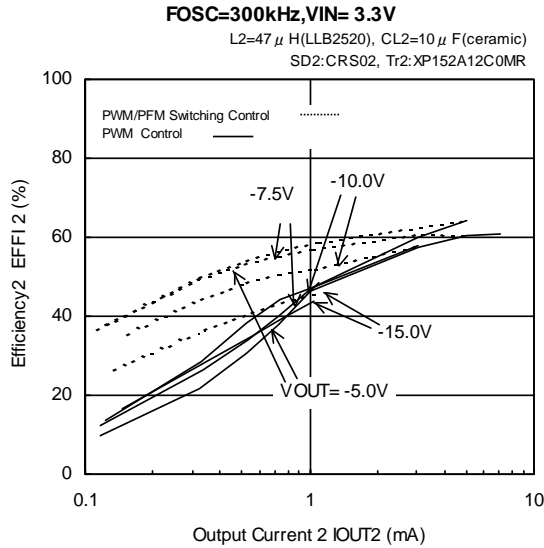

## ■ TYPICAL PERFORMANCE CHARACTERISTICS (Continued)

< 2 ch. Inverting DC/DC Controller > (Continued)

### (7) Breakdown of Coil Inductance Value

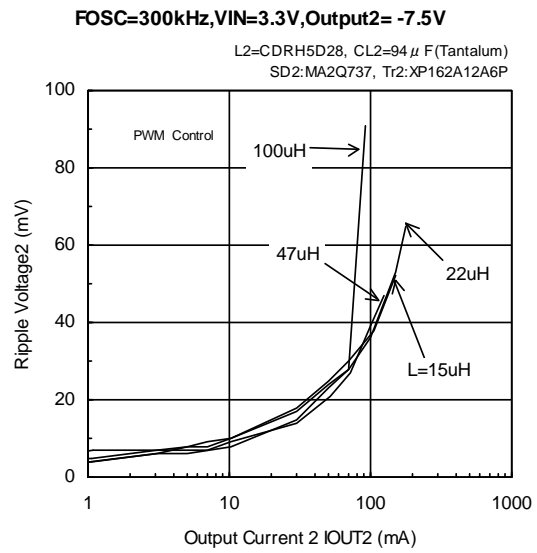
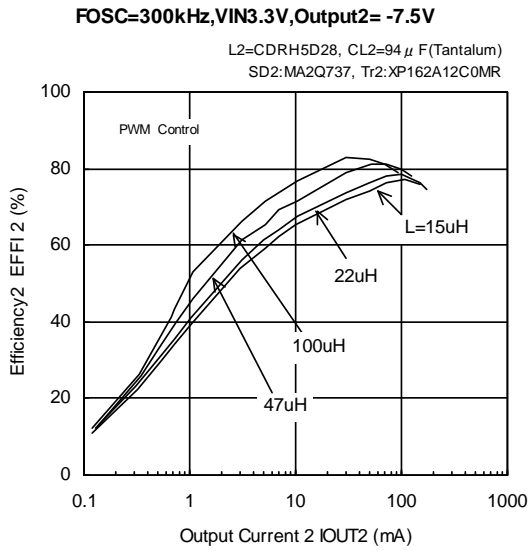

## TYPICAL PERFORMANCE CHARACTERISTICS (Continued)

(8) Supply Current vs. Supply Voltage

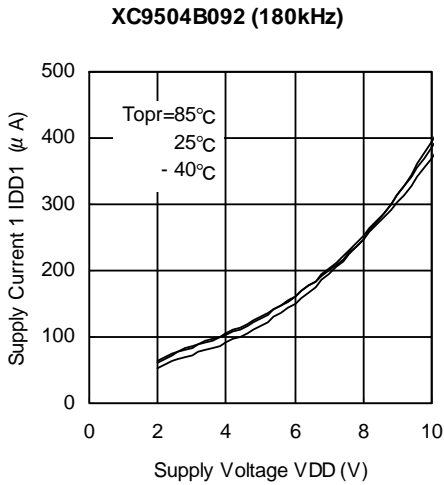

(9) Supply Current vs. Supply Voltage

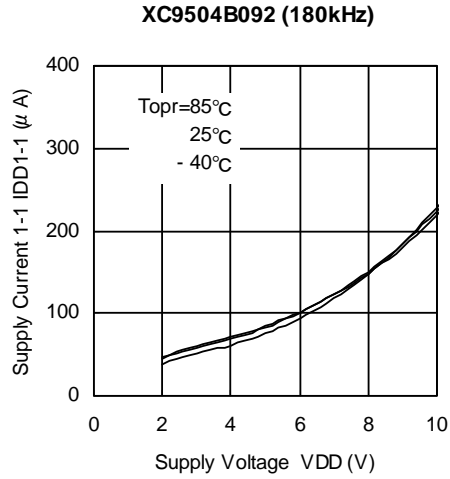

(10) Supply Current 1-2 vs. Supply Voltage

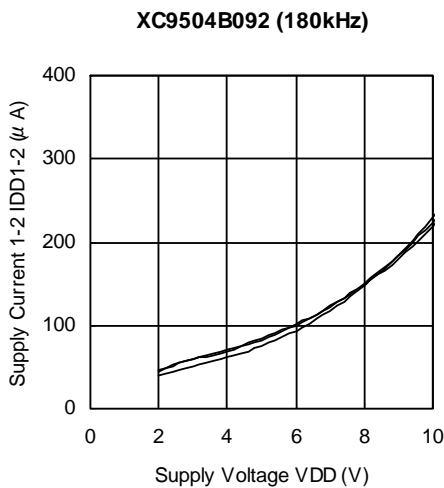

(11) Supply Current 2 vs. Supply Voltage

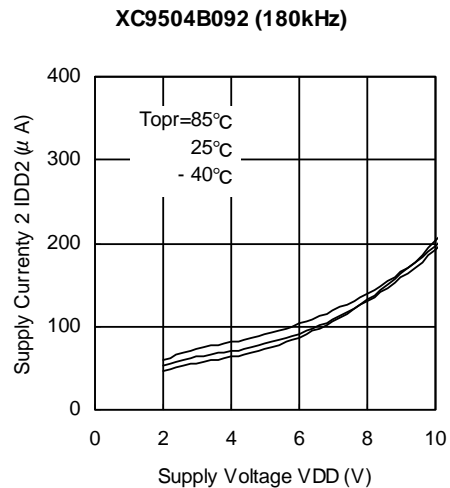

(12) Standby Current vs. Supply Voltage

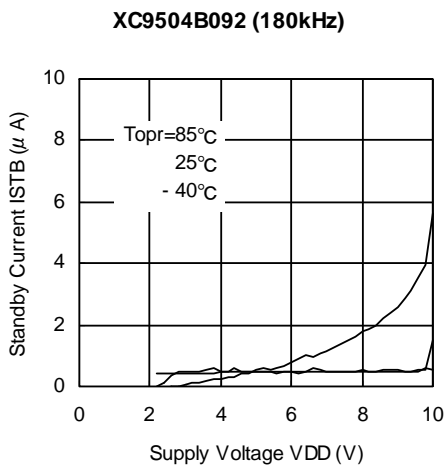

(13) Oscillation Frequency vs. Supply Voltage

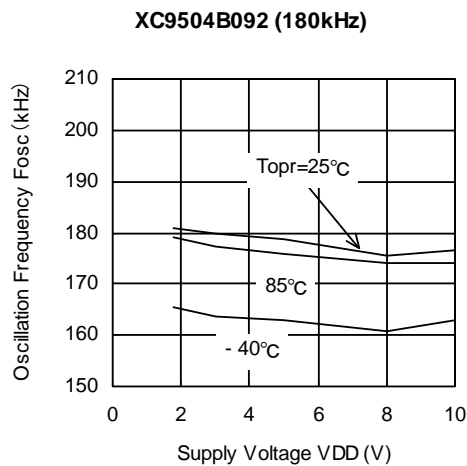

## ■ TYPICAL PERFORMANCE CHARACTERISTICS (Continued)

(14) PWM1, 2 'H'/'L' Voltage vs. Supply Voltage

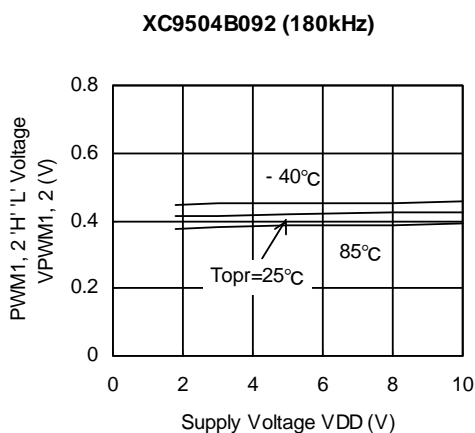

(15) EN1, 2 'H'/'L' Voltage vs. Supply Voltage

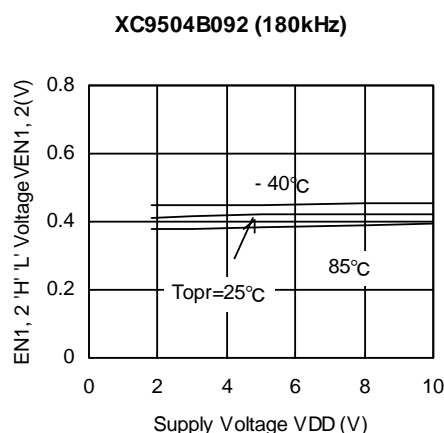

(16) Maximum Duty Ratio 1, 2 vs. Supply Voltage

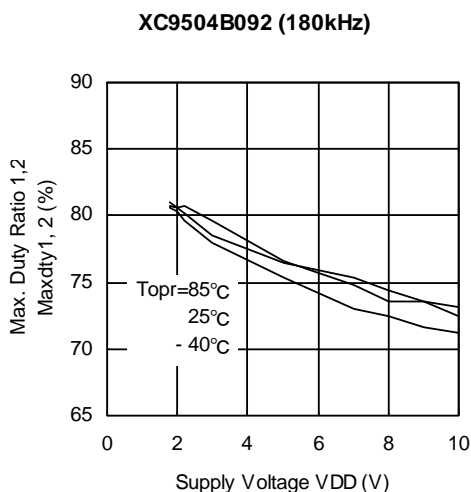

(17) Soft-Start Time 1 vs. Supply Voltage

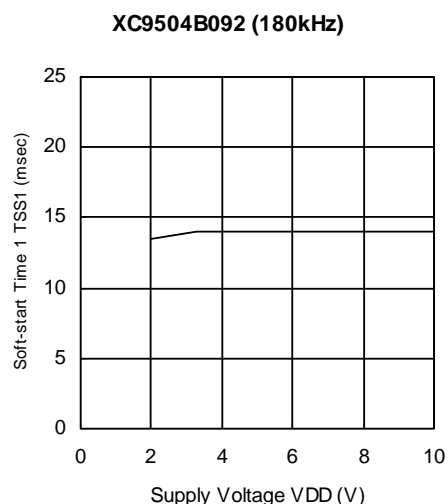

(18) EXT1, 2 High ON Resistance vs. Supply Voltage

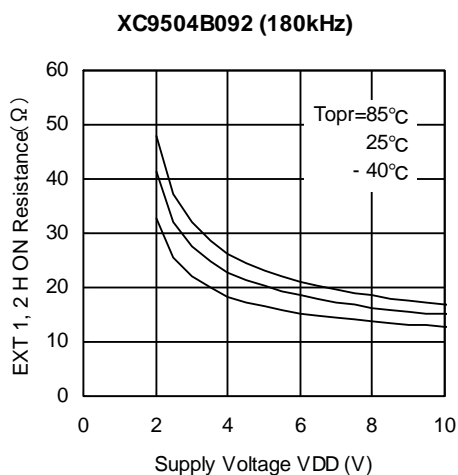

(19) EXT1, 2 Low ON Resistance vs. Supply Voltage

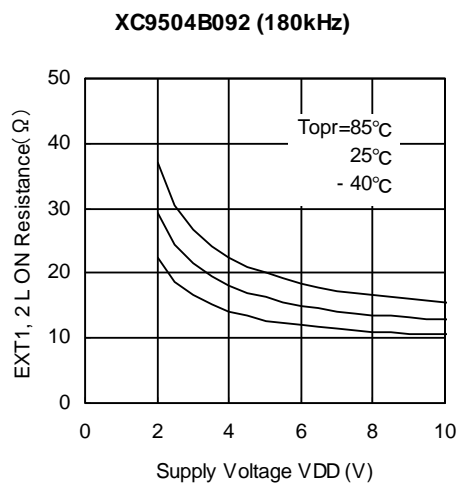

## TYPICAL PERFORMANCE CHARACTERISTICS (Continued)

(20) Operation Start Voltage vs. Ambient Temperature

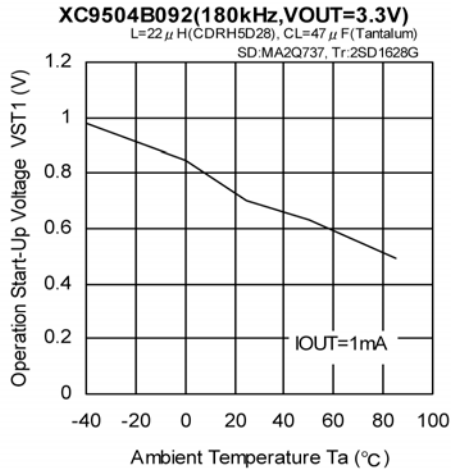

(21) Operation Retention Voltage vs. Ambient Temperature

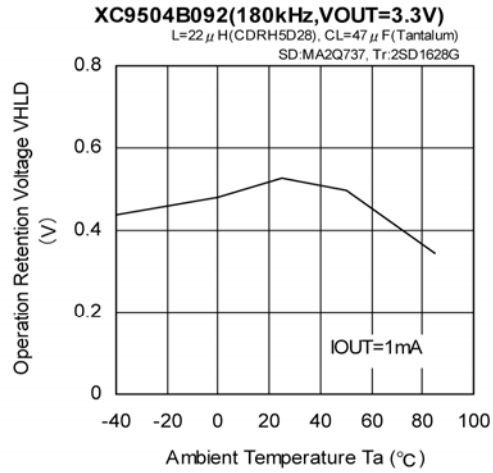

(22) Oscillation Start Voltage vs. Ambient Temperature

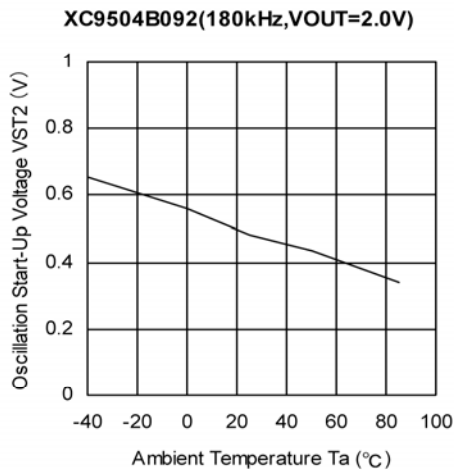

(23) PFM Duty Ratio 1, 2 vs. Supply Voltage

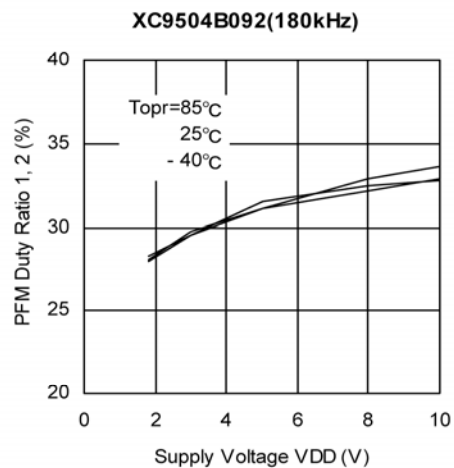

(24) Output Voltage vs. Ambient Temperature

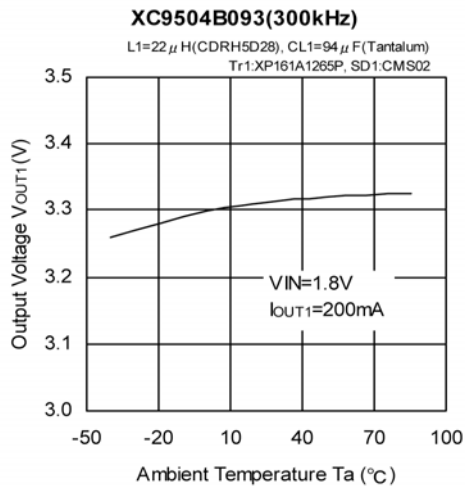



## ■ TYPICAL PERFORMANCE CHARACTERISTICS (Continued)

< 1 ch. Step-Up DC/DC Controller >

(25) Load Transient Response

(Tantalum capacitor use)

<  $V_{OUT1} = 3.3V$ ,  $V_{IN} = 2.0V$ ,  $I_{OUT1} = 100\mu A \leftrightarrow 100mA$  >

### ● PWM Control

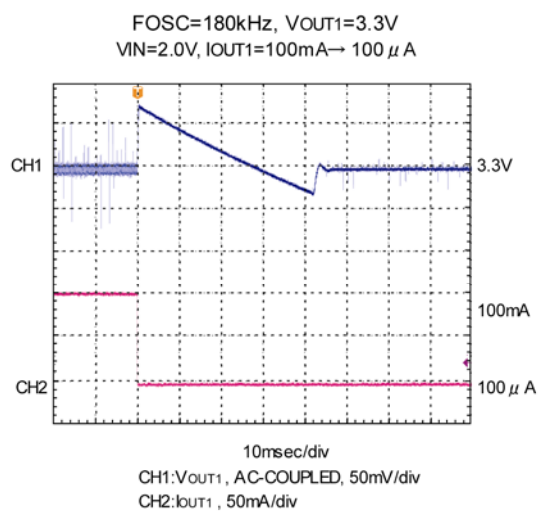
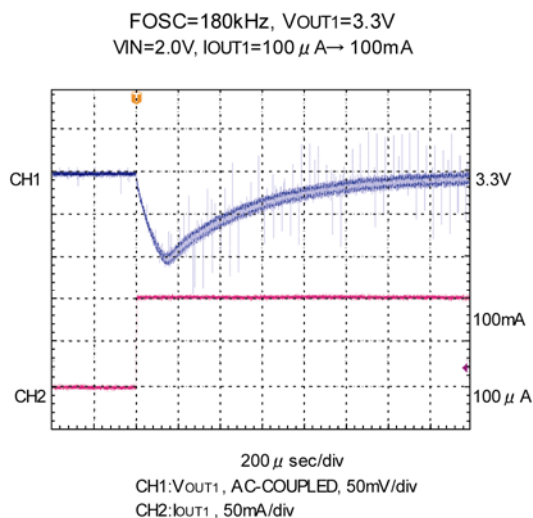

### ● PWM/PFM Switching Control

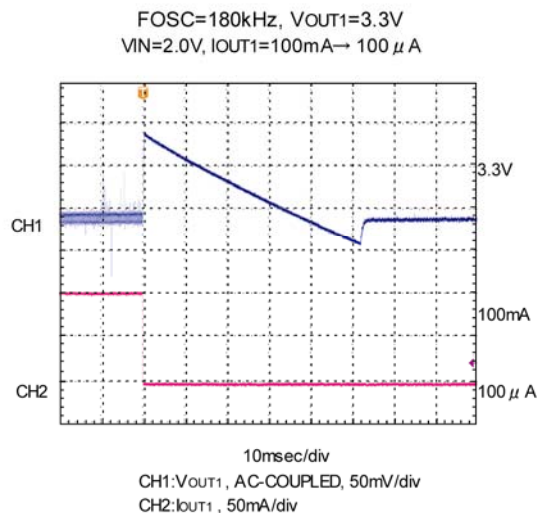
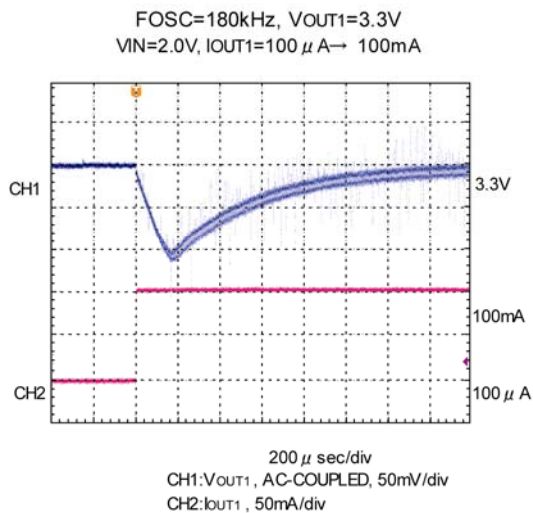

## TYPICAL PERFORMANCE CHARACTERISTICS (Continued)

< 1 ch. Step-Up DC/DC Controller > (Continued)

(25) Load Transient Response (Continued)

(Tantalum capacitor use)

<  $V_{OUT1} = 3.3V$ ,  $V_{IN} = 2.0V$ ,  $I_{OUT1} = 10mA \leftrightarrow 100mA$  >

### PWM Control

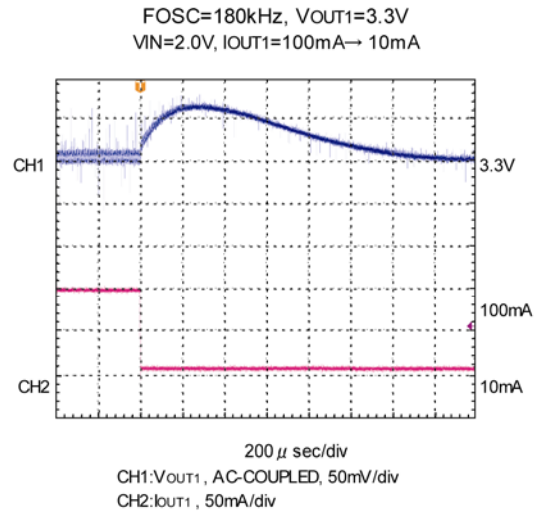
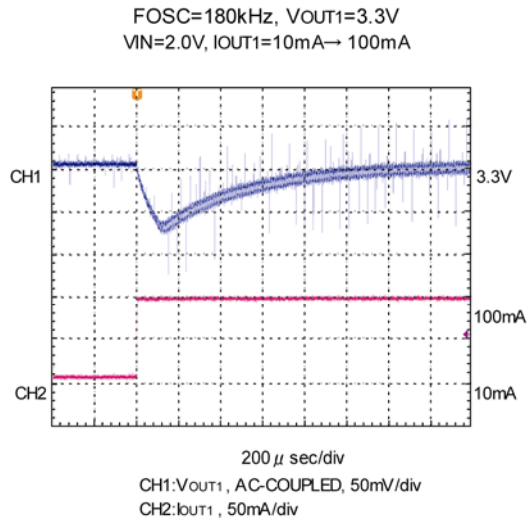

### PWM/PFM Switching Control

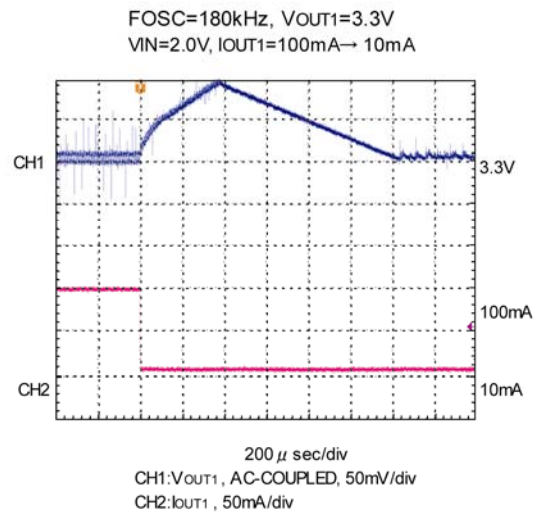
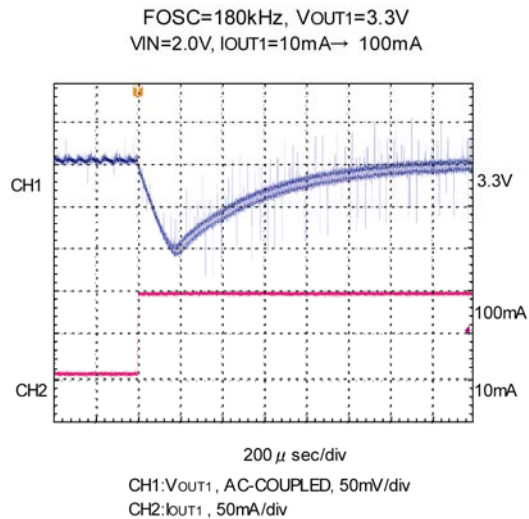

## ■ TYPICAL PERFORMANCE CHARACTERISTICS (Continued)

< 1 ch. Step-Up DC/DC Controller > (Continued)

(25) Load Transient Response (Continued)

(Ceramic capacitor use when coil current is discontinuous. )

<  $V_{OUT1} = 15.0V$ ,  $V_{IN} = 3.3V$ ,  $I_{OUT1} = 100\mu A \leftrightarrow 20mA$  >

### ● PWM Control

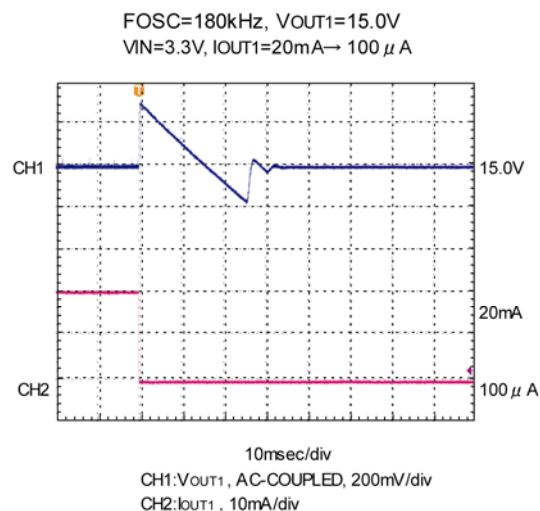
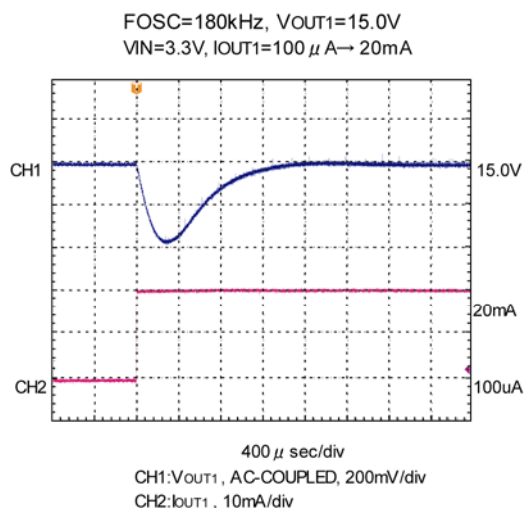

### ● PWM/PFM Switching Control

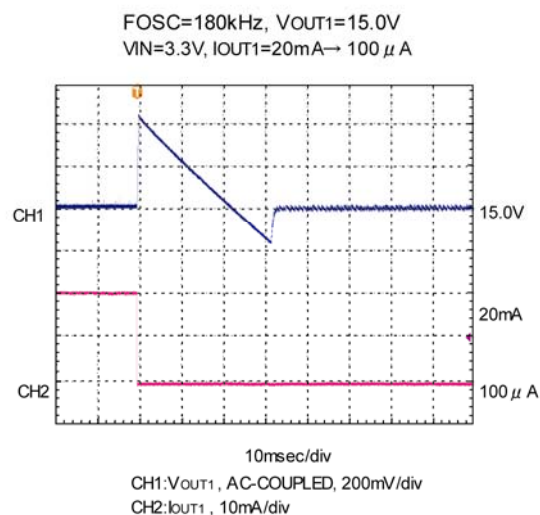
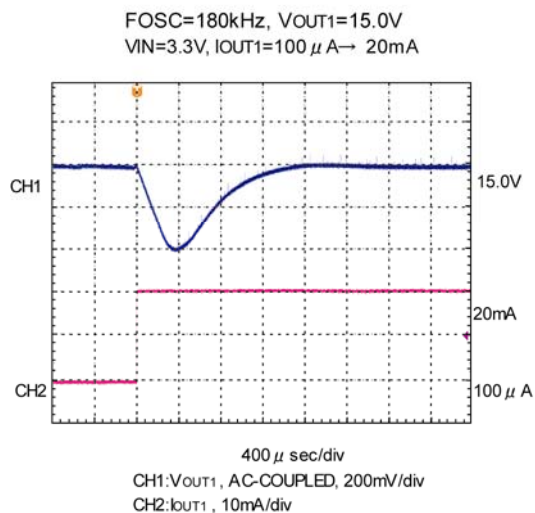

## TYPICAL PERFORMANCE CHARACTERISTICS (Continued)

< 1 ch. Step-Up DC/DC Controller > (Continued)

(25) Load Transient Response (Continued)

(Ceramic capacitor use when coil current is discontinuous.)

<  $V_{OUT1} = 15.0V$ ,  $V_{IN} = 3.3V$ ,  $I_{OUT1} = 1mA \leftrightarrow 20mA$  >

### ● PWM Control

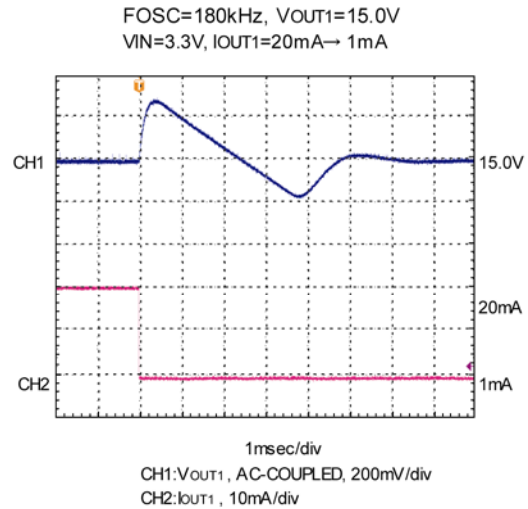
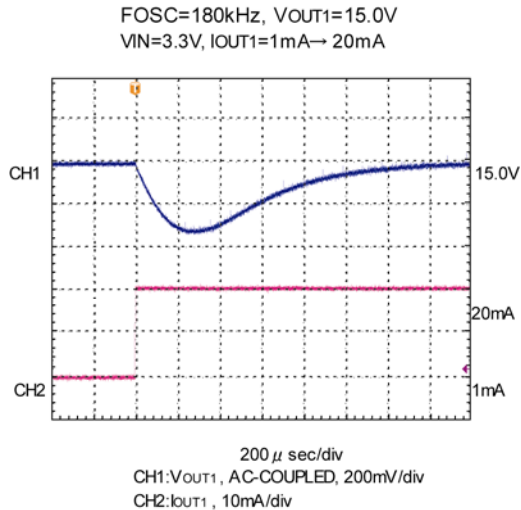

### ● PWM/PFM Switching Control

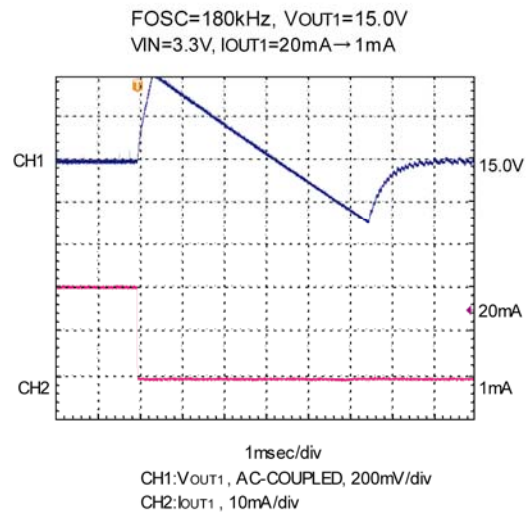
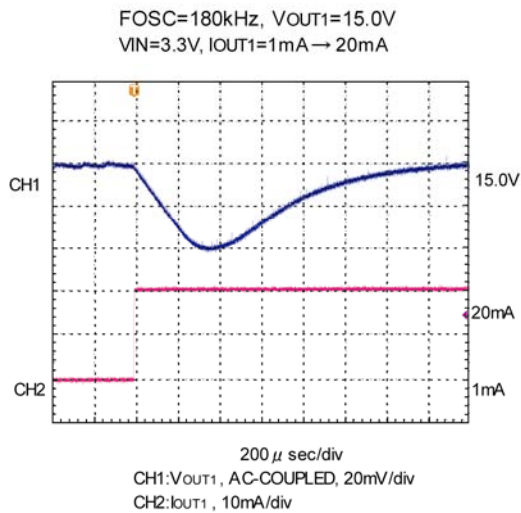

## ■ TYPICAL PERFORMANCE CHARACTERISTICS (Continued)

< 1 ch. Step-Up DC/DC Controller > (Continued)

(25) Load Transient Response (Continued)

(Ceramic capacitor use when coil current is discontinuous.)

< PWM Control ⇔ PWM / PFM Switching Control >

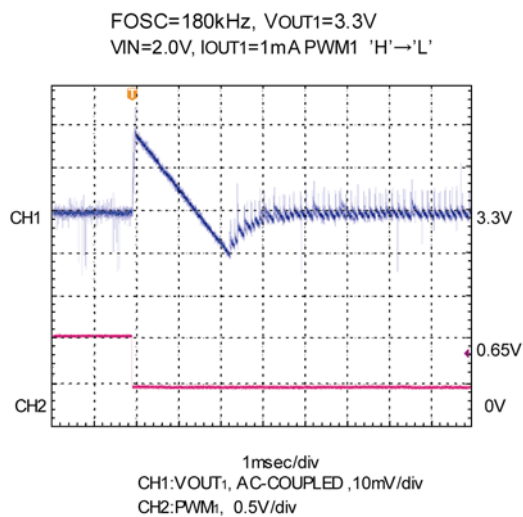
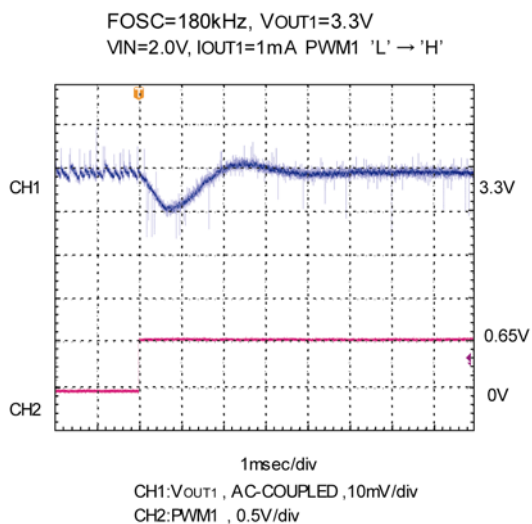

<Soft-start Wave Form>

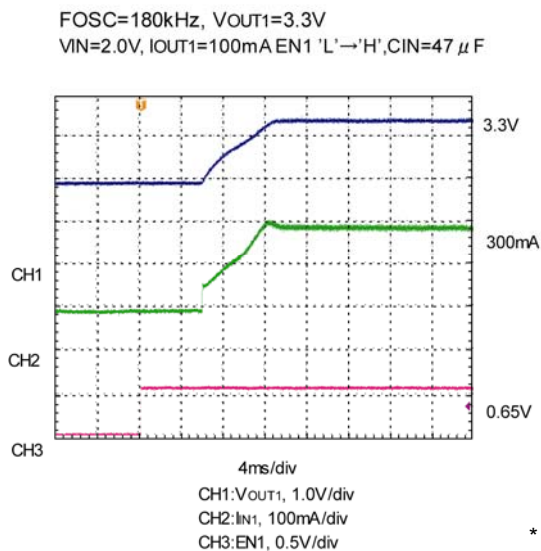

## TYPICAL PERFORMANCE CHARACTERISTICS (Continued)

< 2 ch. Inverting DC/DC Controller >

(25) Load Transient Response (Continued)

(Tantalum capacitor use)

<  $V_{OUT2} = -7.5V$ ,  $V_{IN} = 3.3V$ ,  $I_{OUT2} = 100\mu A \leftrightarrow -50mA$  >

### ● PWM Control

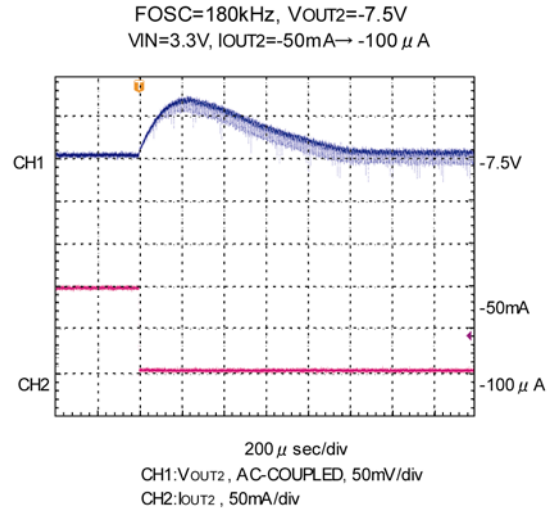
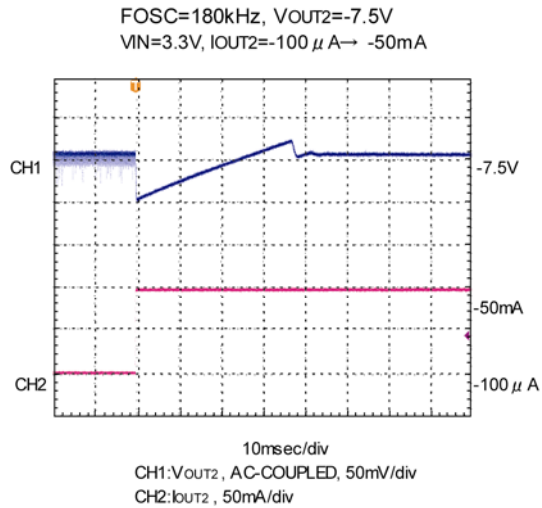

### ● PWM/PFM Switching Control

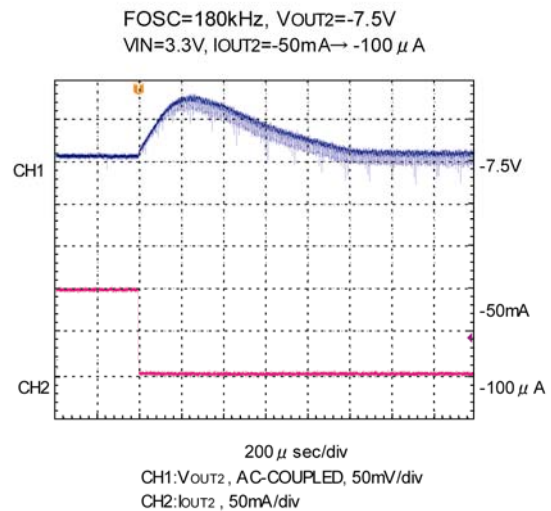
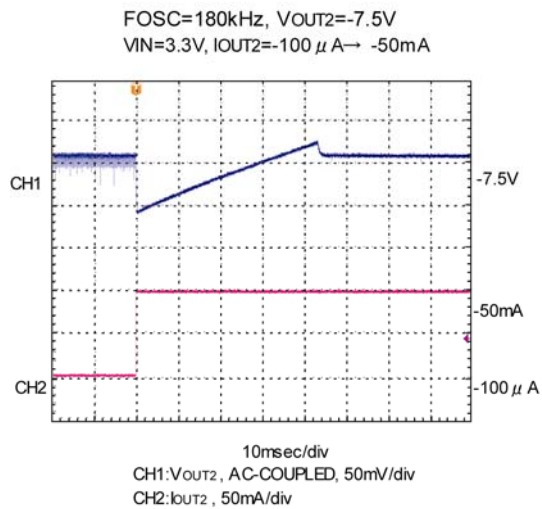

## TYPICAL PERFORMANCE CHARACTERISTICS (Continued)

< 2 ch. Inverting DC/DC Controller > (Continued)

(25) Load Transient Response (Continued)

(Ceramic capacitor Use when coil current is discontinuous.)

<  $V_{OUT2} = -7.5V$ ,  $V_{IN} = 3.3V$ ,  $I_{OUT2} = 100\mu A \leftrightarrow -20mA$  >

### ● PWM Control

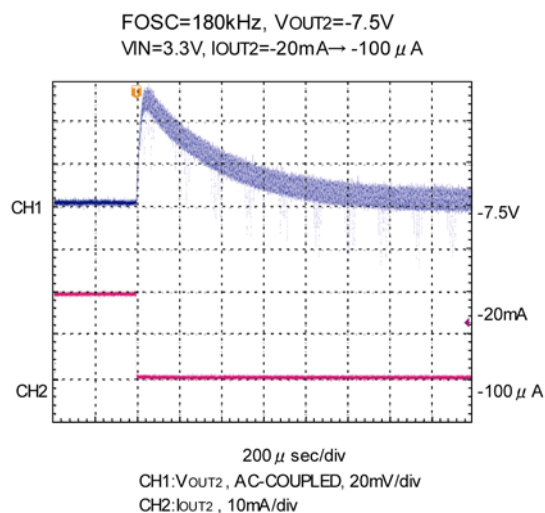
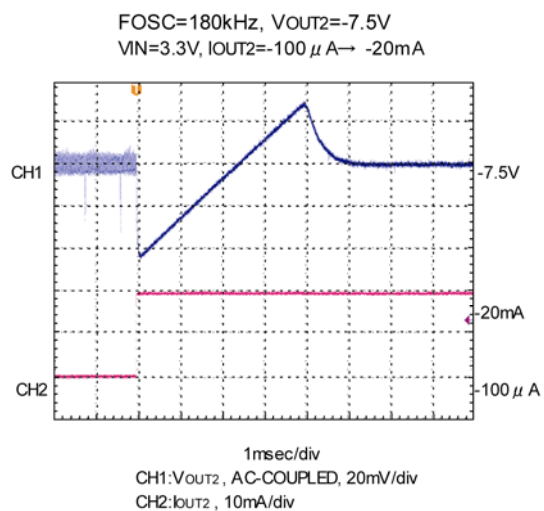

### ● PWM/PFM Switching Control

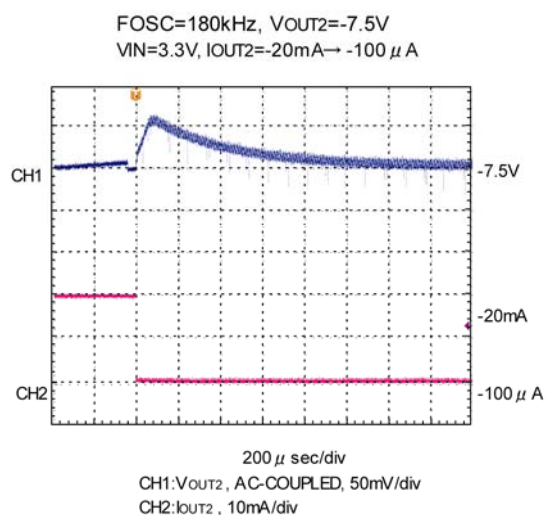
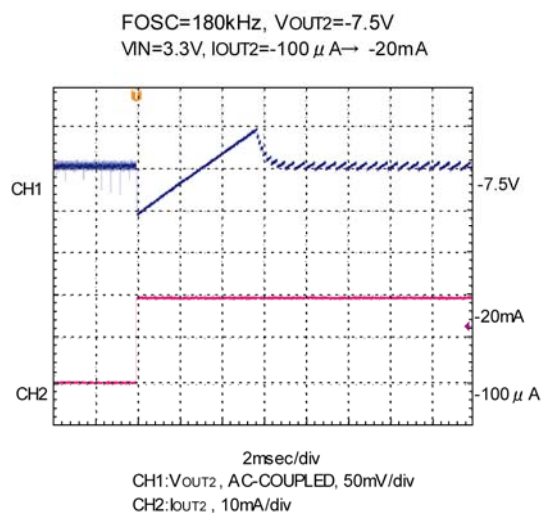

## TYPICAL PERFORMANCE CHARACTERISTICS (Continued)

< 2 ch. Inverting DC/DC Controller > (Continued)

(25) Load Transient Response (Continued)

(Ceramic capacitor use when coil current is discontinuous.)

<  $V_{OUT2} = -7.5V$ ,  $V_{IN} = 3.3V$ ,  $I_{OUT2} = 1mA \leftrightarrow -20mA$  >

### ● PWM Control

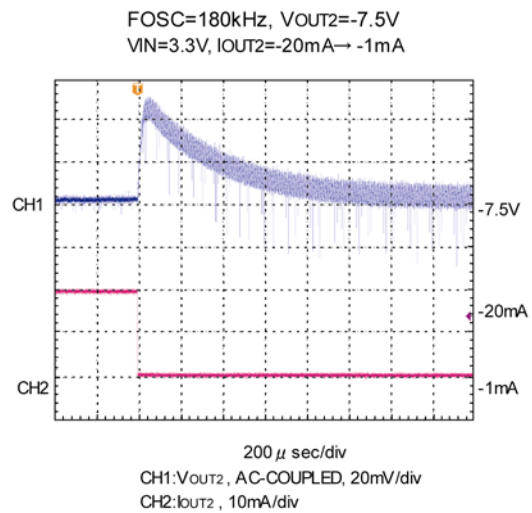
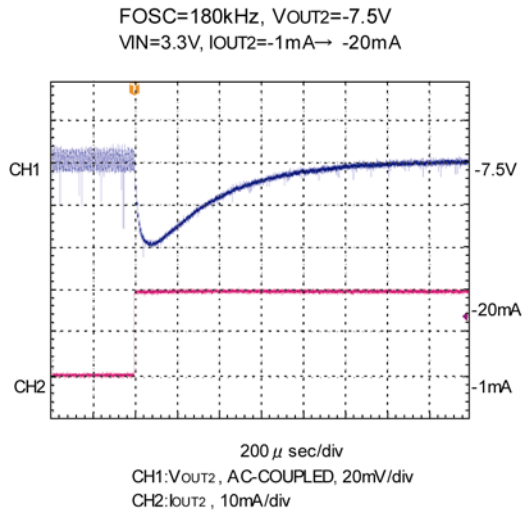

### ● PWM/PFM Switching Control

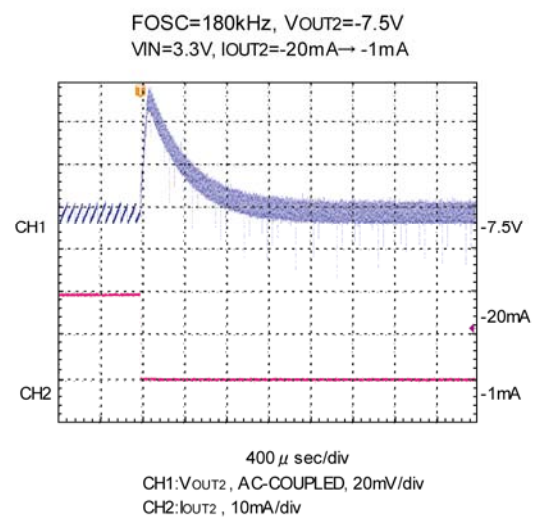
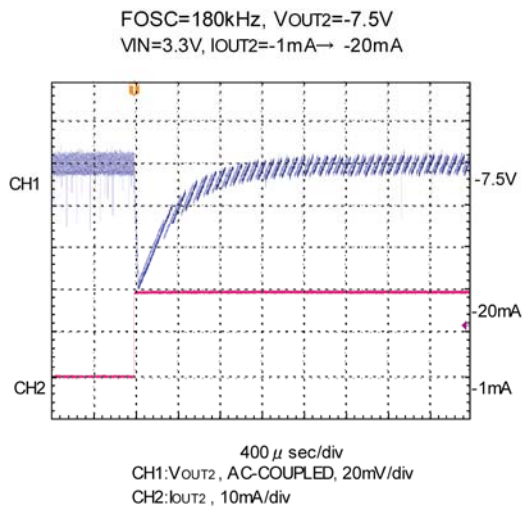



## ■ TYPICAL PERFORMANCE CHARACTERISTICS (Continued)

< 2 ch. Inverting DC/DC Controller > (Continued)

(25) Load Transient Response (Continued)

(Ceramic capacitor use when coil current is discontinuous.)

< PWM Control ⇔ PWM / PFM Switching Control >

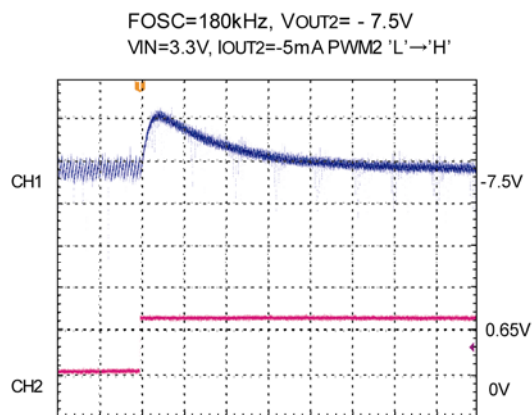

200  $\mu$  sec/div  
CH1:VOUT2 , AC-COUPLED ,20mV/div  
CH2:PWM2 , 0.5V/div

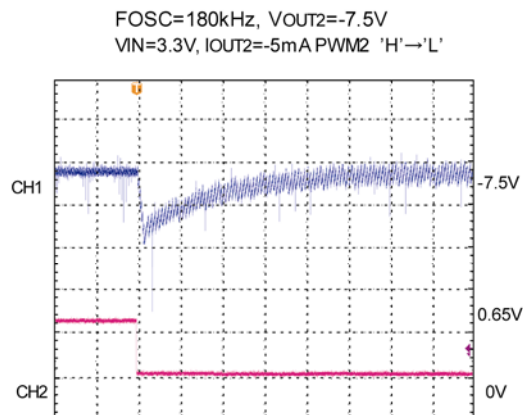

200  $\mu$  sec/div  
CH1:VOUT2 , AC-COUPLED ,20mV/div  
CH2:PWM2 , 0.5V/div

## TYPICAL PERFORMANCE CHARACTERISTICS (Continued)

< 2 ch. Inverting DC/DC Controller > (Continued)

(25) Load Transient Response (Continued)

(Ceramic capacitor use when coil current is discontinuous.)

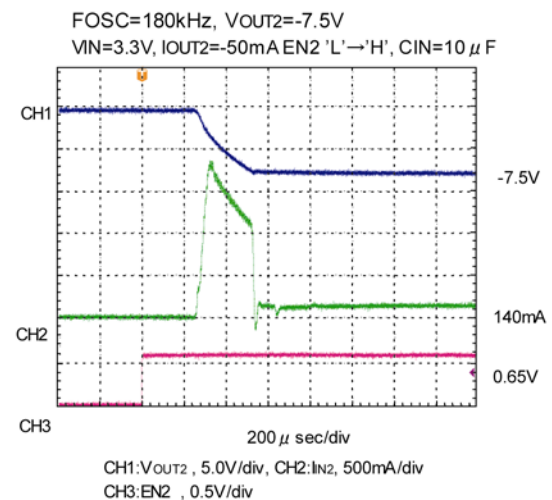
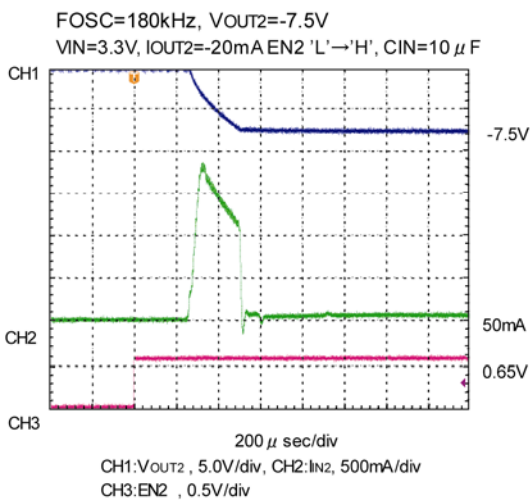
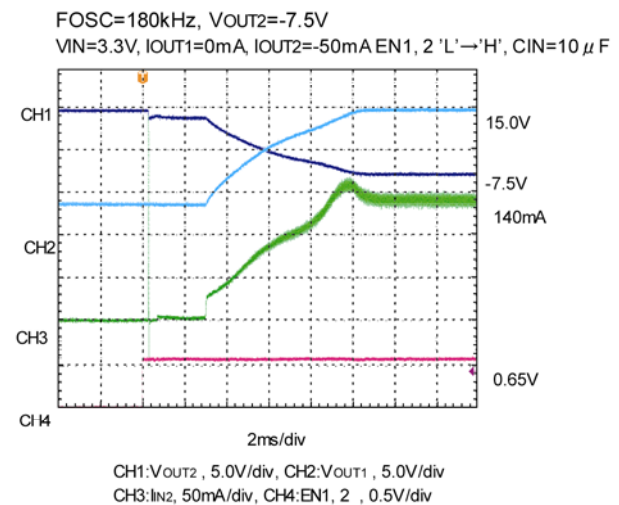
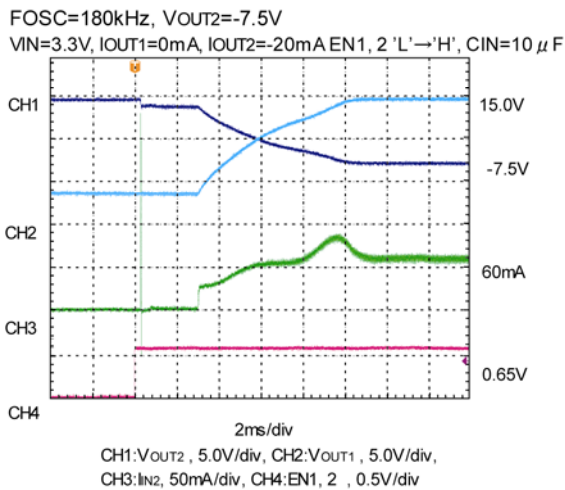
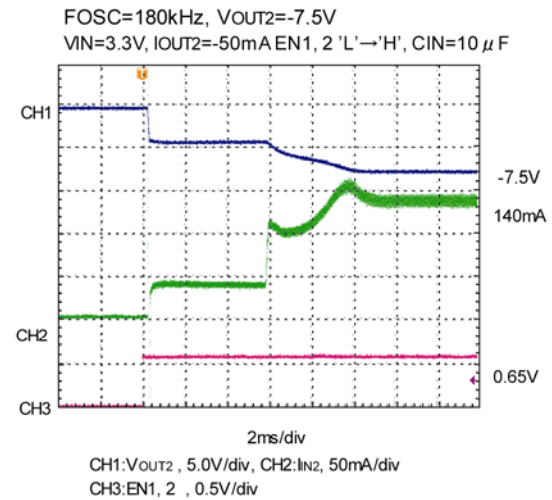
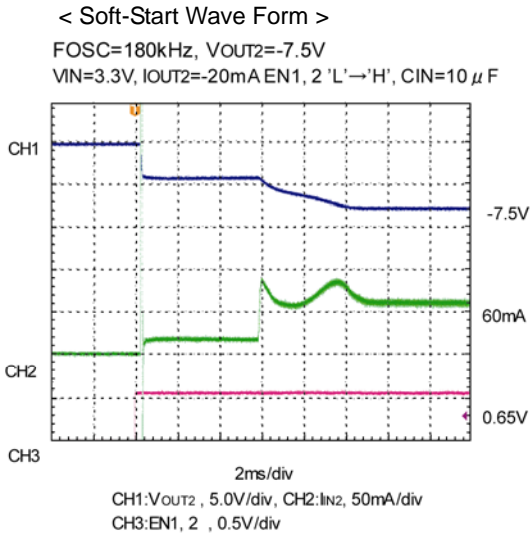

\* EN1=GND

## PACKAGING INFORMATION

● MSOP-10

Unit:mm

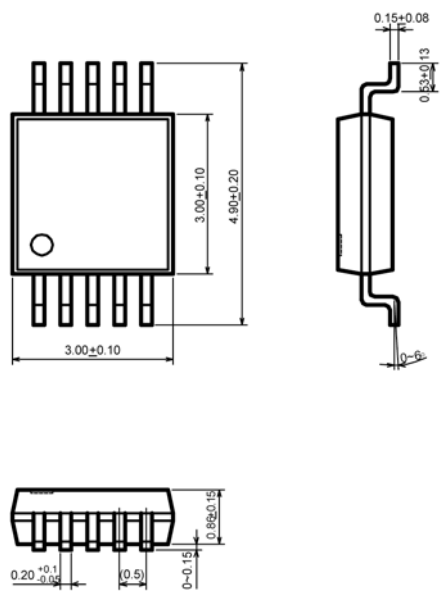

● USP-10

Unit:mm

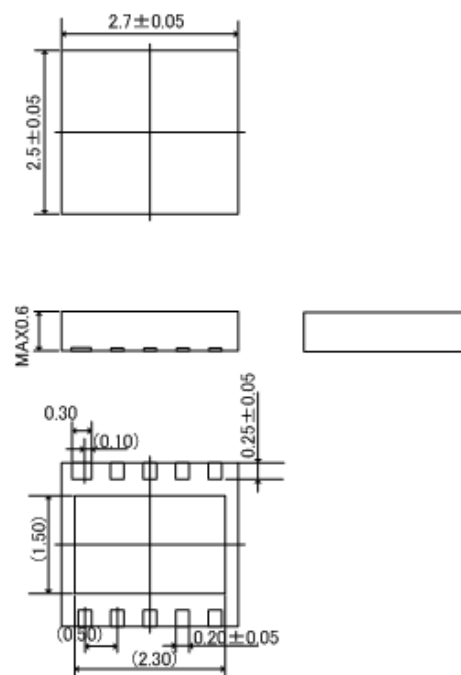

● USP-10 Reference Pattern Layout

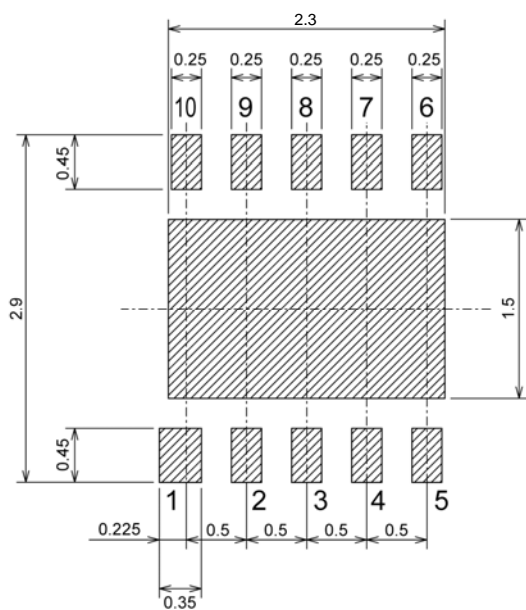

● USP-10 Reference Metal Mask Design

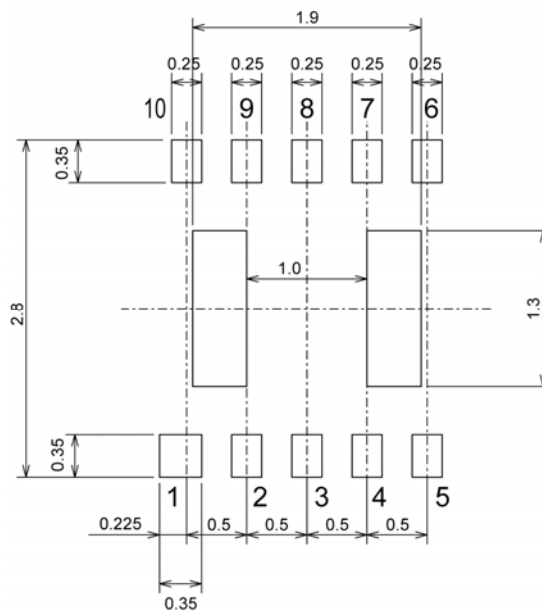

## MARKING RULE

### ● MSOP-10, USP-10

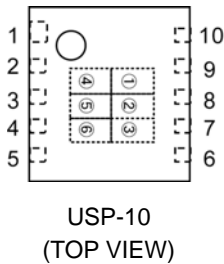
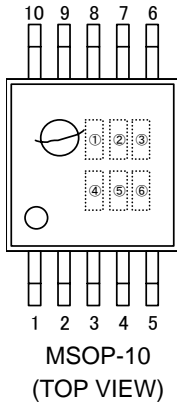

① represents product series

MARK	PRODUCT SERIES
1	XC9504B09xxx

② represents type of DC/DC controller

MARK	PRODUCT SERIES
B	XC9504B09xxx

③,④ represents FB voltage

MARK		VOLTAGE (V)	PRODUCT SERIES
③	④		
0	9	0.9	XC9504B09xxx

⑤ represents oscillation frequency

MARK	OSCILLATION FREQUENCY (kHz)	PRODUCT SERIES
2	180	XC9504B092xx
3	300	XC9504B093xx
5	500	XC9504B095xx

⑥ represents production lot number

0 to 9, A to Z repeated (G, I, J, O, Q, W excluded)

Note: No character inversion used.

1. The products and product specifications contained herein are subject to change without notice to improve performance characteristics. Consult us, or our representatives before use, to confirm that the information in this datasheet is up to date.
2. We assume no responsibility for any infringement of patents, patent rights, or other rights arising from the use of any information and circuitry in this datasheet.
3. Please ensure suitable shipping controls (including fail-safe designs and aging protection) are in force for equipment employing products listed in this datasheet.
4. The products in this datasheet are not developed, designed, or approved for use with such equipment whose failure or malfunction can be reasonably expected to directly endanger the life of, or cause significant injury to, the user.  
(e.g. Atomic energy; aerospace; transport; combustion and associated safety equipment thereof.)
5. Please use the products listed in this datasheet within the specified ranges.  
Should you wish to use the products under conditions exceeding the specifications, please consult us or our representatives.
6. We assume no responsibility for damage or loss due to abnormal use.
7. All rights reserved. No part of this datasheet may be copied or reproduced without the prior permission of TOREX SEMICONDUCTOR LTD.

**TOREX SEMICONDUCTOR LTD.**

单击下面可查看定价，库存，交付和生命周期等信息

[>>Torex Semiconductor\(特瑞仕\)](#)