

2ch. Step-Down / Inverting DC/DC Controller IC

☆GreenOperation-Compatible

■GENERAL DESCRIPTION

XC9505 series are PWM controlled, PWM/PFM switching 2 channel (step-down and inverting) DC/DC controller ICs. With 0.9V of internal standard voltage supply, and using externally connected components, the output 1 voltage (step-down DC/DC controller) can be set freely within a range of 0.9V to 6.0V. Since output 2 (inverting DC/DC controller) has a built-in 0.9V reference voltage (accuracy $\pm 2\%$), a negative voltage can be set with the external components.

With a 180 kHz frequency, the size of the external components can be reduced. Switching frequencies of 300 kHz and 500 kHz are also available as custom designed products.

The control of the XC9505 series can be switched between PWM control and PWM/PFM automatic switching control using external signals. Control switches from PWM to PFM during light loads when automatic switching is selected and the series is highly efficient from light loads through to large output currents. Noise is easily reduced with PWM control since the frequency is fixed.

The series gives freedom of control selection so that control suited to the application can be selected. Soft-start time is internally set to 10ms (output1) which offers protection against rush currents and voltage overshoot when the power is switched on.

■APPLICATIONS

- PDAs
- Palm top computers
- Digital cameras
- Various power supplies

■FEATURES

2 ch. DC/DC Controller (Step-Down / Inverting)

<Output 1: Step-Down DC/DC Controller>

Output Voltage Range : 0.9V ~ 6.0V (set by FB1 pin)
Output Current : More than 1000mA
($V_{IN}=5.0V$, $V_{OUT}=3.3V$)

Maximum Duty Cycle : 100%

Soft-Start Internally Set-Up

<Output 2: Inverting DC/DC Controller>

Output Voltage Range : -30V ~ 0V (set by FB2 pin)
Output Current : More than -100mA
($V_{IN}=5.0V$, $V_{OUT}= -3.3V$)

Maximum Duty Cycle : 80% (TYP.)

<Common>

Operating Voltage Range : 2.0V ~ 10.0V

Oscillation Frequency : 180kHz ($\pm 15\%$)

* 300kHz, 500kHz custom

Control Method : PWM or PWM/PFM Selectable

Stand-by Function : 3.0 μ A (MAX.)

Packages : MSOP-10, USP-10

Environmentally Friendly : EU RoHS Compliant, Pb Free

■TYPICAL APPLICATION CIRCUIT

<XC9505B092A Input: 2 cell, V_{OUT} : 3.3V, V_{OUT} : -5.0V >

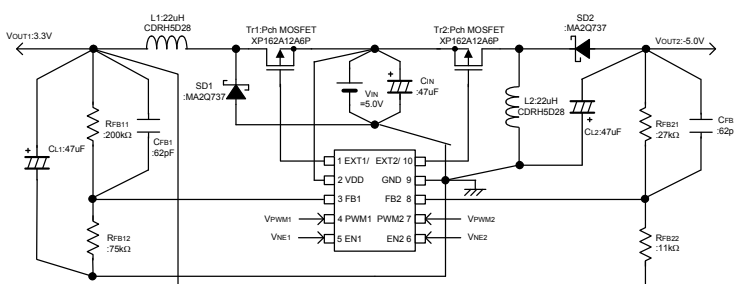

■TYPICAL PERFORMANCE CHARACTERISTICS

●Efficiency vs. Output Current

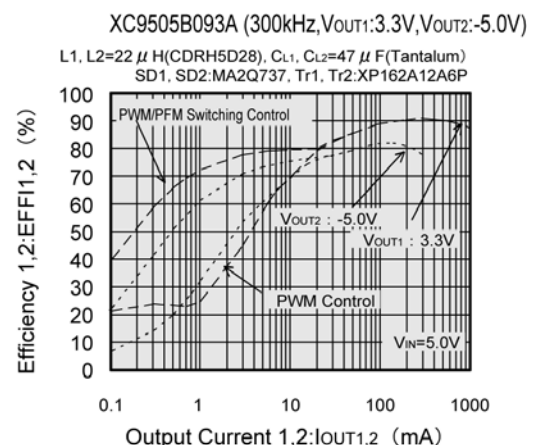

■ PIN CONFIGURATION

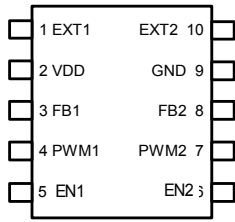

MSOP-10
(TOP VIEW)

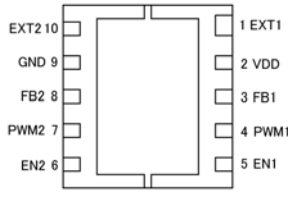

USP-10
(BOTTOM VIEW)

■ PIN ASSIGNMENT

PIN NUMBER	PIN NAME	FUNCTIONS
1	EXT 1	Channel 1: External Transistor Drive Pin <Connected to P-ch Power MOSFET Gate>
2	VDD	Supply Voltage
3	FB1	Channel 1: Output Voltage Monitor Feedback Pin <Threshold value: 0.9V. Output voltage can be set freely by connecting split resistors between VOUT1 and Ground.>
4	PWM1	Channel 1: PWM/PFM Switching Pin <Control Output 1. PWM control when connected to VDD, PWM / PFM auto switching when connected to Ground. >
5	EN1	Channel 1: Enable Pin <Connected to Ground when Output 1 is in stand-by mode. Connected to VDD when Output 1 is active. EXT1 is high when in stand-by mode.>
6	EN2	Channel 2: Enable Pin <Connected to Ground when Output 2 is in stand-by mode. Connected to VDD when Output 2 is active. EXT2/ is high when in stand-by mode.>
7	PWM2	Channel 2: PWM/PFM Switching Pin <Control Output 2. PWM control when connected to VDD, PWM / PFM auto switching when connected to Ground.>
8	FB2	Channel 2: Output Voltage Monitor Feedback Pin <Threshold value: 0.9V. Output voltage can be set freely by connecting split resistors between VOUT2 and VOUT1.>
9	GND	Ground
10	EXT2/	Channel 2: External Transistor Drive Pin <Connected to P-ch Power MOSFET Gate>

■ PRODUCT CLASSIFICATION

● Ordering Information

XC9505①②③④⑤⑥-⑦^(*)

MARK	ITEM	SYMBOL	DESCRIPTION
①	Type of DC/DC Controller	B	Standard type (10 pin)
②③	Output Voltage	09	FB products→②=0, ③=9 fixed
④	Oscillation Frequency	2	180kHz
		3	300kHz (custom)
		5	500kHz (custom)
⑤⑥-⑦	Packages (Oder Unit)	AR	MSOP-10 (1,000/Reel)
		AR-G	MSOP-10 (1,000/Reel)
		DR	USP-10 (3,000/Reel)
		DR-G	USP-10 (3,000/Reel)

^(*) The "-G" suffix indicates that the products are Halogen and Antimony free as well as being fully RoHS compliant.

■ BLOCK DIAGRAM

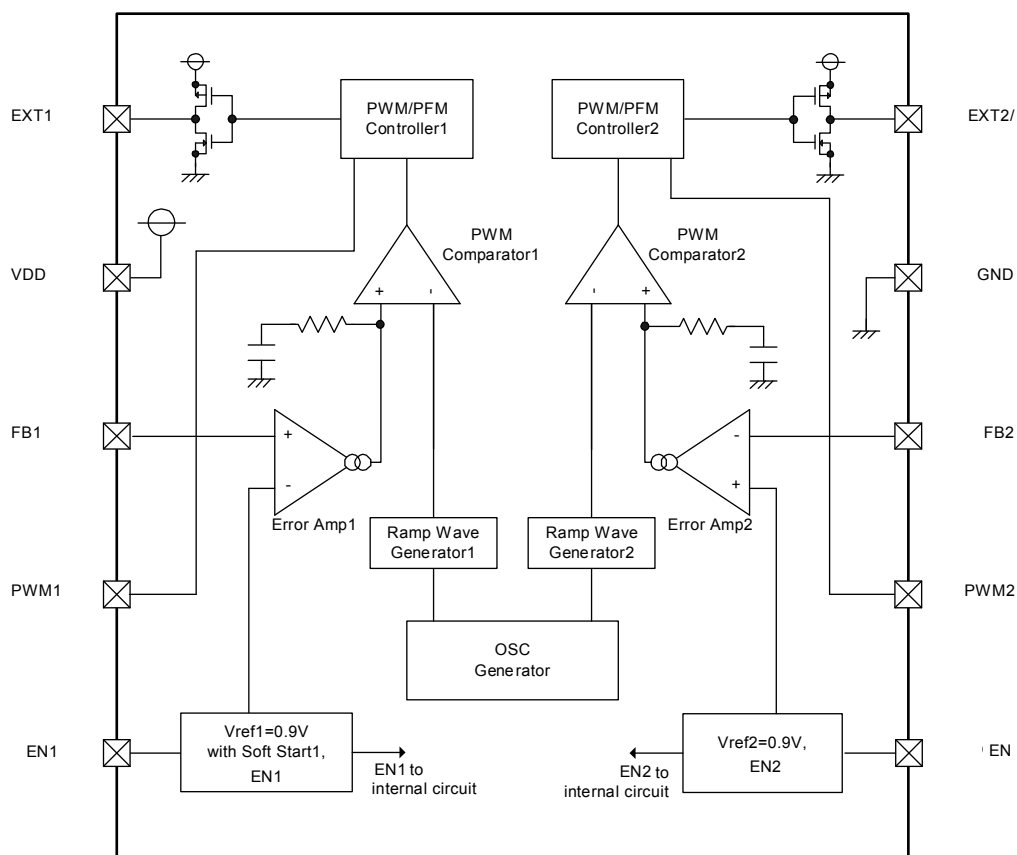

■ ABSOLUTE MAXIMUM RATINGS

Ta=25°C

PARAMETER	SYMBOL	RATINGS	UNITS
VDD Pin Voltage	VDD	- 0.3 ~ 12.0	V
FB1, 2 Pin Voltage	VFB	- 0.3 ~ 12.0	V
EN1, 2 Pin Voltage	VEN	- 0.3 ~ 12.0	V
PWM1, 2 Pin Voltage	VPWM	- 0.3 ~ 12.0	V
EXT1, 2 Pin Voltage	VEXT	- 0.3 ~ VDD + 0.3	V
EXT1, 2 Pin Current	IEXT	± 100	mA
Power Dissipation	MSOP-10	Pd	mW
	USP-10		
Operating Temperature Range	Topr	- 40 ~ + 85	°C
Storage Temperature Range	Tstg	- 55 ~ + 125	°C

ELECTRICAL CHARACTERISTICS

XC9505B092A

Common Characteristics

Ta=25°C

PARAMETER	SYMBOL	CONDITIONS	MIN.	TYP.	MAX.	UNITS	CIRCUIT
Supply Voltage	VDD		2.0	-	10.0	V	-
Output Voltage Range(*1)	VOUTSET	VDD ≥ 2.0V, IOUT1, 2=1mA	$\frac{V_{OUT1}}{V_{OUT2}}$	$\frac{V_{IN}}{V_{OUT2}}$	0.0	V	①
Supply Current 1	IDD1	FB=0V, FB2=1.2V	-	80	160	μA	②
Supply Current 1-1	IDD1-1	EN1=3.0V, EN2=0, FB1=0V	-	50	110	μA	②
Supply Current 1-2	IDD1-2	EN2=3.0V, EN1=0, FB2=1.2V	-	60	120	μA	②
Supply Current 1-3	IDD1-3	FB1=0V, FB2=0V	-	70	120	μA	②
Supply Current 1-4	IDD1-4	FB1=1.2V, FB2=1.2V	-	80	150	μA	②
Supply Current 2	IDD2	FB1=1.2V, FB2=0V	-	70	130	μA	②
Stand-by Current	ISTB	Same as IDD1, EN1=EN2=0V	-	1.0	3.0	μA	②
Oscillation Frequency	fosc	Same as IDD1	153	180	207	kHz	②
EN1, 2 "High" Voltage	VENH	FB1=0V, FB2=3.0V	0.65	-	-	V	②
EN1, 2 "Low" Voltage	VENL	FB1=0V, FB2=3.0V	-	-	0.20	V	②
EN1, 2 "High" Current	IENH	FB1=3.0V, FB2=0V	-	-	0.50	μA	②
EN1, 2 "Low" Current	IENL	EN1, 2=0V, FB1=3.0V, FB2=0V	-	-	-0.50	μA	②
PWM1, 2 "High" Current	IPWMH	FB1=3.0V, FB2=0V, PWM1, 2=3.0V	-	-	0.50	μA	②
PWM1, 2 "Low" Current	IPWML	FB1=3.0V, FB2=0V, PWM1, 2=0V	-	-	-0.50	μA	②
FB1, 2 "High" Current	IFBH	FB1=3.0V, FB2=0.8V	-	-	0.50	μA	②
FB1, 2 "Low" Current	VFBL	FB1=1.0V, FB2=0V	-	-	-0.50	μA	②

Unless otherwise stated, VDD=3.0V, PWM1, 2=3.0V, EN1, 2 = 3.0V

Output 1 Characteristics

Step-Down Controller

Ta=25°C

PARAMETER	SYMBOL	CONDITIONS	MIN.	TYP.	MAX.	UNITS	CIRCUIT
FB1 Voltage	VFB1	VDD=3.0V, VIN=1.5V, IOUT1=10mA	0.882	0.900	0.918	V	③
Minimum Operating Voltage	VINmin1		-	-	2.0	V	①
Maximum Duty Ratio1	MINDTY1	Same as IDD1	100	-	-	%	②
Minimum Duty Ratio1	MAXDTY1	Same as IDD2	-	-	0	%	②
PFM Duty Ratio1	PFMDTY1	No Load, VPWM1=0V	22	30	38	%	④
Efficiency1 (*2)	EFFI1	IOUT1= 250mA, Pch MOSFET: XP162A12A6P	-	92	-	%	④
Soft-Start Time1	tss1	VOUT1 × 0.95V, EN1=0V → 0.65V	5.0	10.0	20.0	ms	④
EXT1 "High" ON Resistance	REXTBH1	FB1=0V, EXT1=VDD -0.4V	-	28	47	Ω	⑤
EXT1 "Low" ON Resistance	REXTBL1	EN1=FB1=1.2V, EXT1=0.4V	-	22	30	Ω	⑤
PWM1 "High" Voltage	VPWMH1	No Load	0.65	-	-	V	④
PWM1 "Low" Voltage	VPWML1	No Load	-	-	0.20	V	④

Unless otherwise stated, VDD=EN1=PWM1=3.0V, EN2=PWM2=GND, EXT2=OPEN, FB2=OPEN, VIN=1.8V

Output 2 Characteristics

Inverting DC/DC Controller

Ta=25°C

PARAMETER	SYMBOL	CONDITIONS	MIN.	TYP.	MAX.	UNITS	CIRCUIT
FB2 Voltage	VFB2	VDD=3.0V	0.882	0.900	0.918	V	②
Operation Start Voltage2	VST1-2	IOUT2=1.0mA, RFB11=200kΩ, RFB12=75kΩ, RFB21=17.5kΩ, RFB22=10kΩ, EN1=PWM1=3.0V	-	-	2.0	V	①
Oscillation Start Voltage2	VST2-2	FB2=1.2V	-	-	2.0	V	②
Maximum Duty Ratio2	MAXDTY2	Same as IDD1	75	80	87	%	②
Minimum Duty Ratio2	MINDTY3	Same as IDD2	-	-	0	%	②
PFM Duty Ratio2	PFMDTY2	No Load, VPWM2=0V	22	30	38	%	⑥
Efficiency2 (*2)	EFFI2	IOUT2= -150mA, Pch MOSFET: XP162A12A6P	-	76	-	%	⑥
EXT2 "High" ON Resistance	REXTBH2	EN2=FB2= 0V, EXT2=VDD-0.4V	-	28	47	Ω	⑤
EXT2 "Low" ON Resistance	REXTBL2	FB2=3.0V, EXT2=0.4V	-	22	30	Ω	⑤
PWM2 "High" Voltage	VPWMH2	No Load	0.65	-	-	V	⑥
PWM2 "Low" Voltage	VPWML2	No Load	-	-	0.20	V	⑥

Unless otherwise stated, VDD=EN2=PWM2=3.0V, PWM1=EN1=GND, EXT1=OPEN, FB1=OPEN, VIN=3.0V

NOTE: *1: Please be careful not to exceed the breakdown voltage level of the peripheral parts.

*2: $EFFI1, 2 = \left\{ \frac{(\text{output voltage}) \times (\text{output current})}{(\text{input voltage}) \times (\text{input current})} \right\} \times 100$

ELECTRICAL CHARACTERISTICS (Continued)

XC9505B093A

Common Characteristics

Ta=25°C

PARAMETER	SYMBOL	CONDITIONS	MIN.	TYP.	MAX.	UNITS	CIRCUIT
Supply Voltage	VDD		2.0	-	10.0	V	-
Output Voltage Range(*1)	VOUTSET	VDD ≥ 2.0V, IOUT1, 2=1mA	0.9	-	VIN	V	①
			-	-	0.0		
Supply Current 1	IDD1	FB=0V, FB2=1.2V	-	100	190	μA	②
Supply Current 1-1	IDD1-1	EN1=3.0V, EN2=0, FB1=0V	-	60	120	μA	②
Supply Current 1-2	IDD1-2	EN2=3.0V, EN1=0, FB2=1.2V	-	80	150	μA	②
Supply Current 1-3	IDD1-3	FB1=0V, FB2=0V	-	80	140	μA	②
Supply Current 1-4	IDD1-4	FB1=1.2V, FB2=1.2V	-	100	180	μA	②
Supply Current 2	IDD2	FB1=1.2V, FB2=0V	-	80	150	μA	②
Stand-by Current	ISTB	Same as IDD1, EN1=EN2=0V	-	1.0	3.0	μA	②
Oscillation Frequency	fosc	Same as IDD1	255	300	345	kHz	②
EN1, 2 "High" Voltage	VENH	FB1=0V, FB2=3.0V	0.65	-	-	V	②
EN1, 2 "Low" Voltage	VENL	FB1=0V, FB2=3.0V	-	-	0.20	V	②
EN1, 2 "High" Current	IENH	FB1=3.0V, FB2=0V	-	-	0.50	μA	②
EN1, 2 "Low" Current	IENL	EN1, 2=0V, FB1=3.0V, FB2=0V	-	-	-0.50	μA	②
PWM1, 2 "High" Current	IPWMH	FB1=3.0V, FB2=0V, PWM1, 2=3.0V	-	-	0.50	μA	②
PWM1, 2 "Low" Current	IPWML	FB1=3.0V, FB2=0V, PWM1, 2=0V	-	-	-0.50	μA	②
FB1, 2 "High" Current	IFBH	FB1=3.0V, FB2=0.8V	-	-	0.50	μA	②
FB1, 2 "Low" Current	VFBL	FB1=1.0V, FB2=0V	-	-	-0.50	μA	②

Unless otherwise stated, VDD=3.0V, PWM1, 2=3.0V, EN1, 2 = 3.0V

Output 1 Characteristics

Step-Down Controller

Ta=25°C

PARAMETER	SYMBOL	CONDITIONS	MIN.	TYP.	MAX.	UNITS	CIRCUIT
FB1 Voltage	VFB1	VDD=3.0V, VIN=1.5V, IOUT1=10mA	0.882	0.900	0.918	V	③
Minimum Operating Voltage	VINmin1		-	-	2.0	V	①
Maximum Duty Ratio1	MINDTY1	Same as IDD1	-	-	100	%	②
Minimum Duty Ratio1	MAXDTY2	Same as IDD2	-	-	-	%	②
PFM Duty Ratio1	PFMDTY1	No Load, VPWM1=0V	22	30	38	%	④
Efficiency1 (*2)	EFFI1	IOUT1= 250mA, Pch MOSFET: XP162A12A6P	-	92	-	%	④
Soft-Start Time1	tss1	VOUT1 × 0.95V, EN1=0V → 0.65V	5.0	10.0	20.0	ms	④
EXT1 "High" ON Resistance	REXTBH1	FB1=0V, EXT1=VDD -0.4V	-	28	47	Ω	⑤
EXT1 "Low" ON Resistance	REXTBL1	EN1=FB1=1.2V, EXT1=0.4V	-	22	30	Ω	⑤
PWM1 "High" Voltage	VPWMH1	No Load	0.65	-	-	V	④
PWM1 "Low" Voltage	VPWML1	No Load	-	-	0.20	V	④

Unless otherwise stated, VDD=EN1=PWM1=3.0V, EN2=PWM2=GND, EXT2=OPEN, FB2=OPEN, VIN=1.8V

Output 2 Characteristics

Inverting DC/DC Controller

Ta=25°C

PARAMETER	SYMBOL	CONDITIONS	MIN.	TYP.	MAX.	UNITS	CIRCUIT
FB2 Voltage	VFB2	VDD=3.0V	0.882	0.900	0.918	V	②
Operation Start Voltage2	VST1-2	IOUT2=1.0mA, RFB11=200kΩ, RFB12=75kΩ, RFB21=17.5kΩ, RFB22=10kΩ, EN1=PWM1=3.0V	-	-	2.0	V	①
Oscillation Start Voltage2	VST2-2	FB2=1.2V	-	-	2.0	V	②
Maximum Duty Ratio2	MAXDTY2	Same as IDD1	75	80	87	%	②
Minimum Duty Ratio2	MINDTY3	Same as IDD2	-	-	0	%	②
PFM Duty Ratio2	PFMDTY2	No Load, VPWM2=0V	22	30	38	%	⑥
Efficiency2 (*2)	EFFI2	IOUT2= -150mA, Pch MOSFET: XP162A12A6P	-	75	-	%	⑥
EXT2 "High" ON Resistance	REXTBH2	EN2=FB2= 0V, EXT2=VDD-0.4V	-	28	47	Ω	⑤
EXT2 "Low" ON Resistance	REXTBL2	FB2=3.0V, EXT2=0.4V	-	22	30	Ω	⑤
PWM2 "High" Voltage	VPWMH2	No Load	0.65	-	-	V	⑥
PWM2 "Low" Voltage	VPWML2	No Load	-	-	0.20	V	⑥

Unless otherwise stated, VDD=EN2=PWM2=3.0V, PWM1=EN1=GND, EXT1=OPEN, FB1=OPEN, VIN=3.0V

NOTE: *1: Please be careful not to exceed the breakdown voltage level of the peripheral parts.

*2: EFFI1, 2={ [(output voltage) x (output current)] / [(input voltage) x (input current)] } x 100

ELECTRICAL CHARACTERISTICS (Continued)

XC9505B095A

Common Characteristics

Ta=25°C

PARAMETER	SYMBOL	CONDITIONS	MIN.	TYP.	MAX.	UNITS	CIRCUIT	
Supply Voltage	VDD		2.0	-	10.0	V	-	
Output Voltage Range(*1)	VOUTSET	VDD ≥ 2.0V, IOUT1, 2=1mA	VOUT1	0.9	-	VIN	V	①
			VOUT2	-	-	0.0		
Supply Current 1	IDD1	FB=0V, FB2=1.2V	-	130	250	μA	②	
Supply Current 1-1	IDD1-1	EN1=3.0V, EN2=0, FB1=0V	-	80	150	μA	②	
Supply Current 1-2	IDD1-2	EN2=3.0V, EN1=0, FB2=1.2V	-	110	220	μA	②	
Supply Current 1-3	IDD1-3	FB1=0V, FB2=0V	-	100	170	μA	②	
Supply Current 1-4	IDD1-4	FB1=1.2V, FB2=1.2V	-	140	230	μA	②	
Supply Current 2	IDD2	FB1=1.2V, FB2=0V	-	100	190	μA	②	
Stand-by Current	ISTB	Same as IDD1, EN1=EN2=0V	-	1.0	3.0	μA	②	
Oscillation Frequency	fOSC	Same as IDD1	425	500	575	kHz	②	
EN1, 2 "High" Voltage	VENH	FB1=0V, FB2=3.0V	0.65	-	-	V	②	
EN1, 2 "Low" Voltage	VENL	FB1=0V, FB2=3.0V	-	-	0.20	V	②	
EN1, 2 "High" Current	IENH	FB1=3.0V, FB2=0V	-	-	0.50	μA	②	
EN1, 2 "Low" Current	IENL	EN1, 2=0V, FB1=3.0V, FB2=0V	-	-	-0.50	μA	②	
PWM1, 2 "High" Current	IPWMH	FB1=3.0V, FB2=0V, PWM1, 2=3.0V	-	-	0.50	μA	②	
PWM1, 2 "Low" Current	IPWML	FB1=3.0V, FB2=0V, PWM1, 2=0V	-	-	-0.50	μA	②	
FB1, 2 "High" Current	IFBH	FB1=3.0V, FB2=0.8V	-	-	0.50	μA	②	
FB1, 2 "Low" Current	VFBL	FB1=1.0V, FB2=0V	-	-	-0.50	μA	②	

Unless otherwise stated, VDD=3.0V, PWM1, 2=3.0V, EN1, 2 = 3.0V

Output 1 Characteristics

Step-Down Controller

Ta=25°C

PARAMETER	SYMBOL	CONDITIONS	MIN.	TYP.	MAX.	UNITS	CIRCUIT
FB1 Voltage	VFB1	VDD=3.0V, VIN=1.5V, IOUT1=10mA	0.882	0.900	0.918	V	③
Minimum Operating Voltage	VINmin1		-	-	2.0	V	①
Maximum Duty Ratio1	MINDTY1	Same as IDD1	-	-	100	%	②
Minimum Duty Ratio1	MAXDTY2	Same as IDD2	-	-	0	%	②
PFM Duty Ratio1	PFMDTY1	No Load, VPWM1=0V	22	30	38	%	④
Efficiency1 (*2)	EFFI1	IOUT1= 250mA, P-ch MOSFET: XP162A12A6P	-	91	-	%	④
Soft-Start Time1	tSS1	VOUT1 × 0.95V, EN1=0V → 0.65V	5.0	10.0	20.0	ms	④
EXT1 "High" ON Resistance	REXTBH1	FB1=0V, EXT1=VDD -0.4V	-	28	47	Ω	⑤
EXT1 "Low" ON Resistance	REXTBL1	EN1=FB1=1.2V, EXT1=0.4V	-	22	30	Ω	⑤
PWM1 "High" Voltage	VPWMH1	No Load	0.65	-	-	V	④
PWM1 "Low" Voltage	VPWML1	No Load	-	-	0.20	V	④

Unless otherwise stated, VDD=EN1=PWM1=3.0V, EN2=PWM2=GND, EXT2=OPEN, FB2=OPEN, VIN=1.8V

Output 2 Characteristics

Inverting DC/DC Controller

Ta=25°C

PARAMETER	SYMBOL	CONDITIONS	MIN.	TYP.	MAX.	UNITS	CIRCUIT
FB2 Voltage	VFB2	VDD=3.0V	0.882	0.900	0.918	V	②
Operation Start Voltage2	VST1-2	IOUT2=1.0mA, RFB11=200kΩ, RFB12=75kΩ, RFB21=17.5kΩ, RFB22=10kΩ, EN1=PWM1=3.0V	-	-	2.0	V	①
Oscillation Start Voltage2	VST2-2	FB2=1.2V	-	-	2.0	V	②
Maximum Duty Ratio2	MAXDTY2	Same as IDD1	75	80	87	%	②
Minimum Duty Ratio2	MINDTY3	Same as IDD2	-	-	0	%	②
PFM Duty Ratio2	PFMDTY2	No Load, VPWM2=0V	22	30	38	%	⑥
Efficiency2 (*2)	EFFI2	IOUT2= -150mA, P-ch MOSFET: XP162A12A6P	-	71	-	%	⑥
EXT2 "High" ON Resistance	REXTBH2	EN2=FB2= 0V, EXT2=VDD-0.4V	-	28	47	Ω	⑤
EXT2 "Low" ON Resistance	REXTBL2	FB2=3.0V, EXT2=0.4V	-	22	30	Ω	⑤
PWM2 "High" Voltage	VPWMH2	No Load	0.65	-	-	V	⑥
PWM2 "Low" Voltage	VPWML2	No Load	-	-	0.20	V	⑥

Unless otherwise stated, VDD=EN2=PWM2=3.0V, PWM1=EN1=GND, EXT1=OPEN, FB1=OPEN, VIN=3.0V

NOTE: *1: Please be careful not to exceed the breakdown voltage level of the peripheral parts.

*2: EFFI1, 2= { [(output voltage) x (output current)] / [(input voltage) x (input current)] } x 100

■ OPERATIONAL DESCRIPTION

The XC9505 series are dual DC/DC (step-down + inverting) converter controller ICs with built-in high speed, low ON resistance buffers.

<Error Amp. 1>

Error amplifier 1 is designed to monitor the output voltage and it compares the feedback voltage 1 (FB1) with the reference voltage Vref1. In response to feedback of a voltage lower than the reference voltage Vref1, the output voltage of the error amp. decreases.

<Error Amp. 2>

Error amplifier 2 is designed to monitor the output voltage and it compares the feedback voltage 2 (FB2) with the reference voltage Vref 2. In response to feedback of a voltage lower than the reference voltage Vref2, the output voltage of the error amp. decreases.

<OSC Generator>

This circuit generates the internal reference clock.

<Ramp Wave Generator 1, 2>

The ramp wave generator generates a saw-tooth waveform based on outputs from the OSC generator.

<PWM Comparator 1, 2>

The PWM comparator compares outputs from the error amp. and saw-tooth waveform. When the voltage from the error amp's output is low, the external switch will be set to ON.

<PWM/PFM Controller 1, 2>

This circuit generates PFM pulses.

Control can be switched between PWM control and PWM/PFM automatic switching control using external signals.

The PFM/PWM automatic switching mode is selected when the voltage of the PWM1 (2) pin is less than 0.2V, and the control switches between PWM and PFM automatically depending on the load. As the PFM circuit generates pulses based on outputs from the PWM Comparator, shifting between modes occurs smoothly. PWM control mode is selected when the voltage of the PWM1 (2) pin is more than 0.65V. Noise is easily reduced with PWM control since the switching frequency is fixed. Control suited to the application can easily be selected which is useful in audio applications, for example, where traditionally, efficiencies have been sacrificed during stand-by as a result of using PWM control (due to the noise problems associated with the PFM mode in stand-by).

<Vref 1 with Soft Start 1>

The reference voltage, Vref1 (FB1 pin voltage)=0.9V, is adjusted and fixed by laser trimming (for output voltage settings, please refer to the functional settings on next page.). To protect against inrush current, when the power is switched on, and also to protect against voltage overshoot, soft-start time is set internally to 10ms. It should be noted, however, that this circuit does not protect the load capacitor (CL) from inrush current. With the Vref voltage limited, and depending upon the input to error amp 1, the operation maintains a balance between the two inputs of error amps and controls the EXT pin's ON time so that it doesn't increase more than is necessary.

<Vref 2>

The reference voltage, Vref2 (FB2 pin voltage)=0.9V, is adjusted and fixed by laser trimming.

<Enable Function 1,2>

This function controls the operation and shutdown of the IC. When the voltage of the EN1 or EN2 pins is 0.2V or less, the mode will be disable, the channel's operations will stop and the EXT1 and the EXT2 pin will be kept at a high level (the external P-ch MOSFET will be OFF). When both EN1 and EN2 are in a state of chip disable, current consumption will be no more than 3.0 μ A. When the EN1 or EN2 pin's voltage is 0.65V or more, the mode will be enable and operations will recommence. With channel one (output 1) soft-start, 95% of the set output voltage will be reached within 10ms (TYP.) from the moment of enable.

OPERATING EXPLANATION

< Output Voltage Setting, Ch.1 (Step-up DC/DC Converter Controller) >

Output voltage can be set by adding external split resistors. Output voltage is determined by the following equation, based on the values of RFB11 and RFB12. The sum of RFB11 and RFB12 should normally be 1MΩ or less.

$$V_{OUT1} = 0.9 \times (R_{FB11} + R_{FB12}) / R_{FB12}$$

The speed-up capacitor for phase compensation's (CFB1) value should be adjusted using the formula $f_{zfb} = 1 / (2 \times \pi \times C_{FB1} \times R_{FB11})$ so that it equals 12kHz. Depending on the application, the inductance value L, and the load capacity value C_L, adjustments to this value are suggested so that the value is somewhere between 1kHz to 50kHz.

[Calculation Example]

When RFB11=200kΩ and RFB12=75kΩ : $V_{OUT1} = 0.9 \times (200k + 75k) / 75k = 3.3V$.

[Typical Example]

VOUT (V)	RFB11 (kΩ)	RFB12 (kΩ)	CFB1 (pF)	VOUT (V)	RFB11 (kΩ)	RFB12 (kΩ)	CFB1 (pF)
1.0	30	270	430	2.5	390	220	33
1.5	220	330	62	2.7	360	180	33
1.8	220	220	62	3.0	560	240	24
2.0	330	270	39	3.3	200	75	62
2.2	390	270	33	5.0	82	18	160

< Output Voltage Setting, Ch.2 (Inverting DC/DC Converter) >

Output voltage can be set by adding reference voltage and split resistors externally. Output voltage is determined using the following equation and is based on the values of RFB21 and RFB22. The sum of RFB21 and RFB22 should normally be 500kΩ or less. The equation uses Ch 1's (VOUT1) output voltage calculation method for the reference voltage.

$$V_{OUT2} = (0.9 - V_{OUT1}) \times (R_{FB21} / R_{FB22}) + 0.9V$$

[Calculation Example]

When RFB21=17.5kΩ RFB22=10kΩ, VOUT1=3.3V, VOUT2= - 3.3V

The value of speed-up capacitor for phase compensation CFB21:

[Conditions: Heavy load (when coil current is continuous.)]

$$f_{zfb2} = 1/2 \times \pi \times C_{FB21} \times R_{FB21} = 10kHz$$

Depending on the application, the inductance value L, and the load capacity value C_L, adjustments to this value are suggested so that the value is somewhere between 0.1kHz to 50kHz.

[Conditions: Light load (when coil current is discontinuous.)]

Less than CFB21=0.1μF

Depending on the application, the inductance value L, and the load capacity value C_L, adjustments to this value are suggested.

> Example Circuit 1: Using voltage of Ch 1 (Step-Down)

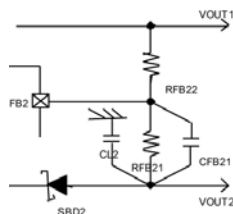

Channel 1 (Step-Down) circuits should be enabled by setting EN1 to High level so that a stable voltage is provided. Inrush current to the inverter when the supply voltage V_{DD} of the IC is 2.0 V or higher can be controlled by setting EN 1 and EN 2 to enable ("H" level) simultaneously.

> Example Circuit 2: Using a positive regulator

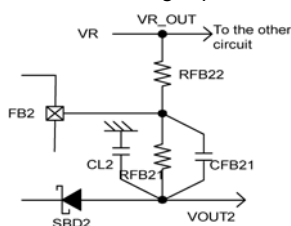

A stable positive voltage produced by a positive-voltage regulator or by other means is usable.

$$V_{OUT2} = (0.9 - V_{ROUT}) \times (R_{FB21} / R_{FB22}) + 0.9V$$

EXTERNAL COMPONENTS

Conditions: Light load (when coil current is discontinuous)

Channel One (Step-Down DC/DC Converter Controller)

Tr 1 : * MOSFET

XP152A12C0 (P-ch Power MOSFET, TOREX)
Note: V_{GS} Breakdown Voltage of this Tr. is 12V so please be careful with the power supply voltage.

SD 1 : CRS02 (Schottky, TOSHIBA)
L1 : 10 μH (CDRH4D18C, SUMIDA, D412F, TOKO, f_{OSC} = 500kHz)
15 μH (CDRH4D18C, SUMIDA, D412F, TOKO, f_{OSC} = 300kHz)
22 μH (CDRH4D18C, SUMIDA, D412F, TOKO, f_{OSC} = 180kHz)

Please set so that the coil current is discontinuous.

CL1 : 10V, 4.7 μF (Ceramic)

***PNP Tr**

2SA1213 (TOSHIBA)

RB1 : 500Ω Adjust in accordance with load & Tr.'s h_{FE}

$$RB1 \leq (VIN - 0.7) \times (h_{FE} / I_C - R_{EXTBL})$$

CB1 : 2200pF (Ceramic)

$$CB1 \leq (2\pi \times RB1 \times f_{OSC} \times 0.7)$$

Channel Two (Inverter DC/DC Controller)

Tr 2 : * MOSFET

XP152A12C0 (P-ch Power MOSFET, TOREX)
Note: V_{GS} Breakdown Voltage of this Tr. is 12V so please be careful with the power supply voltage.

SD 2 : CRS02 (Schottky, TOSHIBA)
L2 : 10 μH (CDRH4D18C, SUMIDA, D412F, TOKO, f_{OSC} = 500kHz)
15 μH (CDRH4D18C, SUMIDA, D412F, TOKO, f_{OSC} = 300kHz)
22 μH (CDRH4D18C, SUMIDA, D412F, TOKO, f_{OSC} = 180kHz)

Please set so that the coil current is discontinuous.

CL2 : 10V, 4.7 μF (Ceramic)

***PNP Tr**

2SA1213 (TOSHIBA)

RB2 : 500Ω Adjust in accordance with load & Tr.'s h_{FE}

$$RB2 \leq (VIN - 0.7) \times (h_{FE} / I_C - R_{EXTBL})$$

CB2 : 2200pF (Ceramic)

$$CB2 \leq (2\pi \times RB2 \times f_{OSC} \times 0.7)$$

Conditions: Heavy load (when coil current is continuous)

Channel One (Step-Down DC/DC Converter Controller)

Tr 1 : * MOSFET

XP162A12A6P (P-ch Power MOSFET, TOREX)
Note: V_{GS} Breakdown Voltage of this Tr. is 12V so please be careful with the power supply voltage.

SD 1 : MA2Q737 (Schottky, MATSUSHITA)
L1 : CMS02 (Schottky, TOSHIBA) (CDRH5D28, SUMIDA, f_{OSC} = 500kHz)
10 μH (CDRH5D28, SUMIDA, f_{OSC} = 300kHz)
22 μH (CDRH5D28, SUMIDA, f_{OSC} = 180kHz)
47 μH (CDRH5D28, SUMIDA, f_{OSC} = 180kHz)

CL1 : 16V, 47 μF (Tantalum)
CL = (CL standard value) × (I_{OUT1} (mA) / 500mA) × V_{OUT1} / V_{IN}

***PNP Tr**

2SA1213 (TOSHIBA)

RB1 : 500Ω Adjust in accordance with load & Tr.'s h_{FE}

$$RB1 \leq (VIN - 0.7) \times (h_{FE} / I_C - R_{EXTBL})$$

CB1 : 2200pF (Ceramic)

$$CB1 \leq (2\pi \times RB1 \times f_{OSC} \times 0.7)$$

Channel Two (Inverter DC/DC Controller)

Tr 2 : * MOSFET

XP162A12A6P (P-ch Power MOSFET, TOREX)
Note: V_{GS} Breakdown Voltage of this Tr. is 12V so please be careful with the power supply voltage.

SD 2 : MA2Q737 (Schottky, MATSUSHITA)
L2 : CRS02, CMS02 (Schottky, TOSHIBA) (CDRH5D28, SUMIDA, f_{OSC} = 500kHz)
10 μH (CDRH5D28, SUMIDA, f_{OSC} = 300kHz)
15 μH (CDRH5D28, SUMIDA, f_{OSC} = 180kHz)
22 μH (CDRH5D28, SUMIDA, f_{OSC} = 180kHz)

CL2 : 16V, 47 μF (Tantalum)
CL = (CL standard value) × (I_{OUT2} (mA) / 150mA) × V_{OUT2} / V_{IN}

***PNP Tr**

2SA1213 (TOSHIBA)

RB2 : 500Ω Adjust in accordance with load & Tr.'s h_{FE}

$$RB2 \leq (VIN - 0.7) \times (h_{FE} / I_C - R_{EXTBL})$$

CB2 : 2200pF (Ceramic)

$$CB2 \leq (2\pi \times RB2 \times f_{OSC} \times 0.7)$$

NOTES ON USE

Application Hint

1. Channel 2 (Inverting) Soft start circuit

Channel 2 (inverting) is subject to the overshoot of output voltage 2 (V_{OUT2}) at start-up. It is possible to control the overshoot of output voltage 2 (V_{OUT2}), as shown by circuit example 1 in “Output Voltage Settings for Channel 2” in “Function Settings.” In this circuit configuration, EN 1 and EN 2 are enabled simultaneously. This lets output voltage 1 (V_{OUT1}) of channel 1 increase gently as soft start, thereby controlling the overshoot.

> Example of Typical application circuit: Improved Soft start

This example is effective when EN 1 and EN 2 are enabled with different timings under light load condition (the coil current being discontinuous).

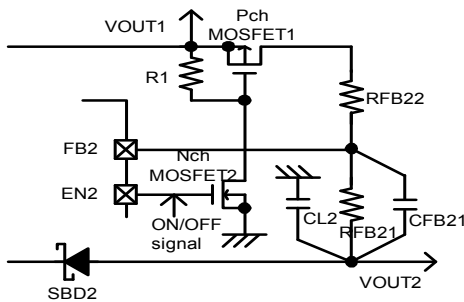

Time to make soft start time t_{SS2} is calculated by the equation below.

$$Time_{SS2} = -R_{FB21} \times C_{CFB21} / \ln \left[1 - \frac{(0.9 - V_{OUT2}) \times R_{FB22}}{(V_{OUT1} - 0.9) \times R_{FB21}} \right]$$

Example)

When $V_{OUT1} = 3.3V$ and $V_{OUT2} = -7.5V$,

$R_{FB21} = 350k\Omega$, $R_{FB22} = 100k\Omega$ by the equation below.

$$V_{OUT2} = (0.9 - V_{OUT1}) \times (R_{FB21} / R_{FB22}) + 0.9$$

When the light load, $C_{FB21} = 0.1 \mu F$ or lower value can be used.

Therefore, when $C_{FB21} = 0.027 \mu F$,

$t_{SS2} = 5.0ms$ and $V_{OUT2} = 95\%$ of setting value

2. Channel 2 (Inverting)

Withstand voltage of transistor

The voltage applied between the drain and source is the sum of V_{IN} and V_{OUT2} .

Select a transistor with an absolute V_{DSS} rating that is suitable for your operating conditions.

Example: The voltage applied across V_{DS} of a transistor will be 20.0V if $V_{IN} = 5.0V$ and $V_{OUT2} = -15.0V$.

Under this condition, a transistor with V_{DSS} higher than 20.0V should be selected. (Use a transistor with V_{DSS} that is 1.5 times the applied voltage or more, as a standard.)

EXTERNAL COMPONENTS OF TEST CIRCUITS

Circuit ①

- L1, L2: 22 μ H (CDRH5D28, SUMIDA) : XC9505B092A
 15 μ H (CDRH5D28, SUMIDA) : XC9505B093A
 10 μ H (CDRH5D28, SUMIDA) : XC9505B095A
- SD1, SD2 : CRS02 (Schottky, TOSHIBA)
 EC10QS06 (Schottky, NIHON INTER)
- CL1, CL2 : 16MCE476MD2 (Tantalum, NIHON CHEMICON)
 35MCE335MB x 3 (Tantalum, NIHON CHEMICON)
- CIN : 16MCE476MD2
- PNP Tr 1 : 2SA1213 (TOSHIBA)
- PNP Tr 2 : 2SA1213 (TOSHIBA)
- RFB : Please use by the conditions as below.
 $R_{FB11} + R_{FB12} \leq 1M \Omega$
 $R_{FB21} + R_{FB22} \leq 1M \Omega$
 $R_{FB11} / R_{FB12} = (\text{Setting Output Voltage} / 0.9) - 1$
 $V_{OUT2} = (0.9 - V_{OUT1}) / (R_{FB21} / R_{FB22}) + 0.9V$
- CFB : $f_{zfb} = 1 / (2 \times \pi \times C_{FB1} \times R_{FB11}) = 1kHz \text{ to } 50kHz (12kHz \text{ usual})$
 $f_{zfb} = 1 / (2 \times \pi \times C_{FB2} \times R_{FB21}) = 1kHz \text{ to } 50kHz (12kHz \text{ usual}).$

Circuit ③

- L1 : 22 μ H (SUMIDA CDRH5D28)
- SD 1 : MA2Q737 (Schottky, MATSUSHITA)
- CL1 : 16MCE476MD2 (Tantalum, NIHONCHEMICON)
- CIN : 16MCE476MD2 (Tantalum, NIHONCHEMICON)
- Pch MOSFET : XP162A12A6P (TOREX)

Circuit ④

- L1 : 22 μ H (CDRH5D28, SUMIDA) : XC9505B092A
 15 μ H (CDRH5D28, SUMIDA) : XC9505B093A
 10 μ H (CDRH5D28, SUMIDA) : XC9505B095A
- SD 1 : MA2Q737 (Schottky, MATSUSHITA)
- CL1 : 16MCE476MD2 (Tantalum, NIHONCHEMICON)
- CIN : 16MCE476MD2 (Tantalum, NIHONCHEMICON)
- Pch MOSFET : XP162A12A6P (TOREX)

Circuit ⑥

- L2 : 22 μ H (CDRH5D28, SUMIDA) : XC9505B092A
 15 μ H (CDRH5D28, SUMIDA) : XC9505B093A
 10 μ H (CDRH5D28, SUMIDA) : XC9505B095A
- SD 2 : MA2Q737 (Schottky, MATSUSHITA)
- CL2 : 16MCE476MD2 (Tantalum, NIHONCHEMICON)
- CIN : 16MCE476MD2 (Tantalum, NIHONCHEMICON)
- Pch MOSFET : XP162A12A6P (TOREX)

■ NOTES ON USE

1. Checking for Intermittent Oscillation

The XC9505 series is subject to intermittent oscillation in the proximity of the maximum duty cycle if the step-down ratio is low (e.g., from 4.2 V to 3.3 V) or a heavy load is applied where the duty ratio becomes high. Check waveforms at EXT under your operating conditions. A remedy for this problem is to raise the inductance of coil L or increase the load capacitance C_L .

2. PWM/PFM Automatic Switching

If PWM/PFM automatic switching control is selected and the step-down ratio is high (e.g., from 10.0 V to 1.0 V), the control mode remains in PFM setting over the whole load range, since the duty ratio under continuous-duty condition is smaller than the PFM duty ratio of the XC9505 series. The output voltage's ripple voltage becomes substantially high under heavy load conditions, with the XC9505 series appearing to be producing an abnormal oscillation. If this operation becomes a concern, set pins PWM to High to set the control mode to PWM setting. For use under the above-mentioned condition, measured data of PWM/PFM automatic switching control shown on the data sheets are available up to $I_{OUT} = 100$ mA.

3. Ratings

Use the XC9505 series and peripheral components within the limits of their ratings.

TYPICAL PERFORMANCE CHARACTERISTICS

< 1 ch Step-Down DC/DC Controller >

(1) Output Voltage vs. Output Current

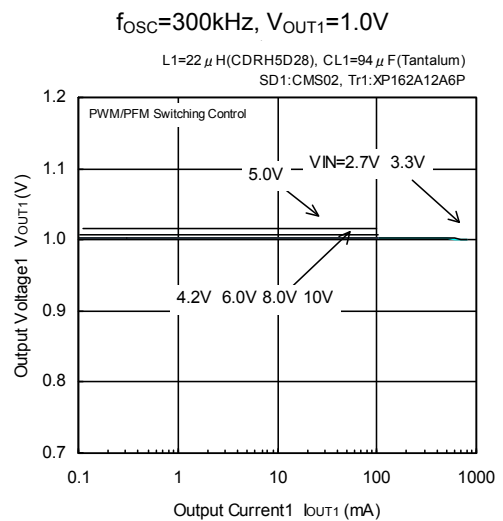
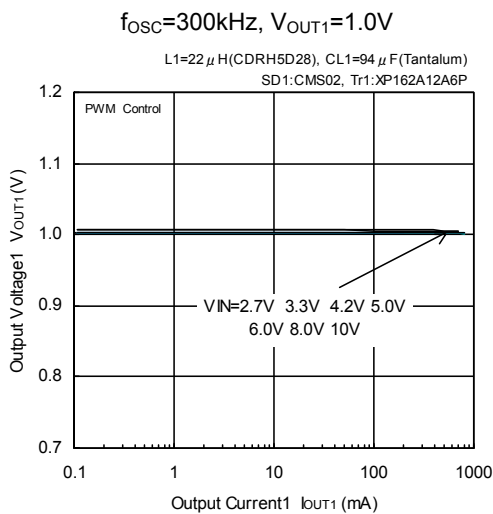
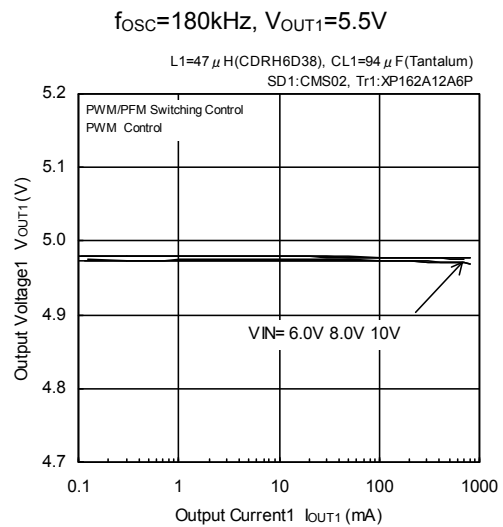
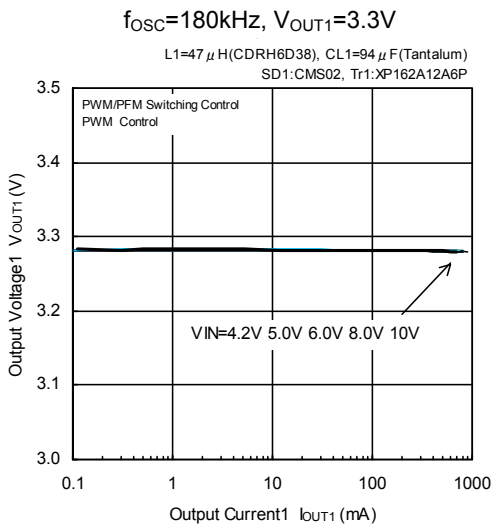
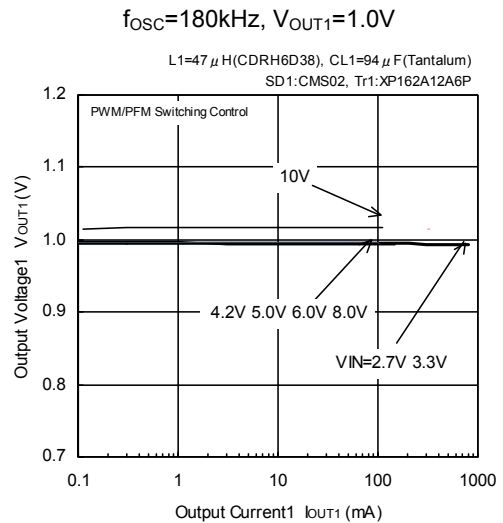
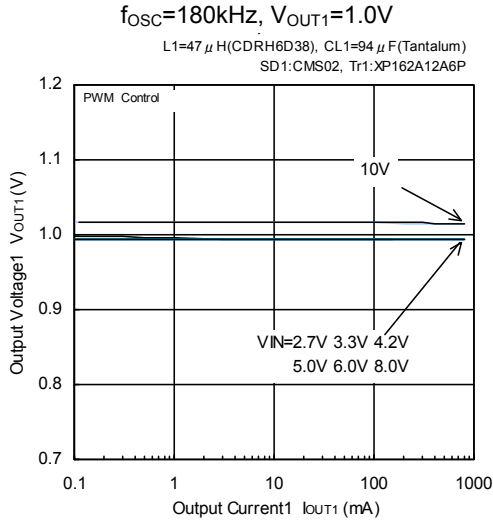

* When setting $V_{OUT1}=1.0V$, $V_{IN}=8.0V$ or $10.0V$,
 $CL=94 \mu$ F (Tantalum) + 100μ F (OS Capacitor)

■ TYPICAL PERFORMANCE CHARACTERISTICS (Continued)

< 1 ch Step-Down DC/DC Controller > (Continued)

(1) Output Voltage vs. Output Current (Continued)

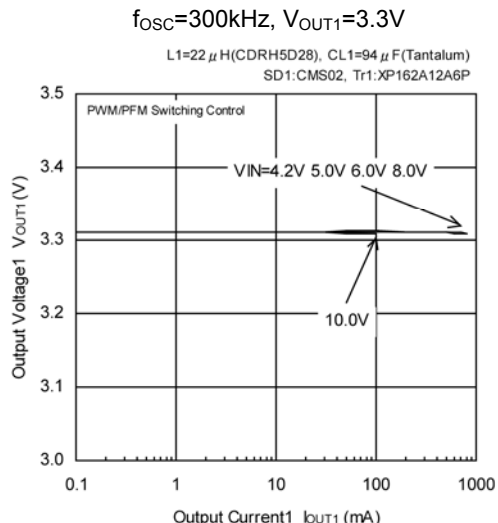
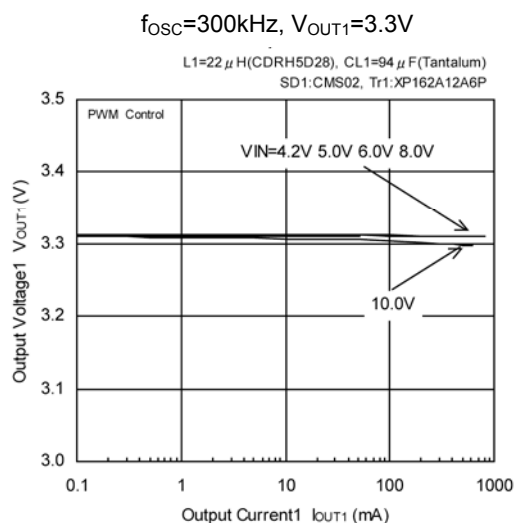
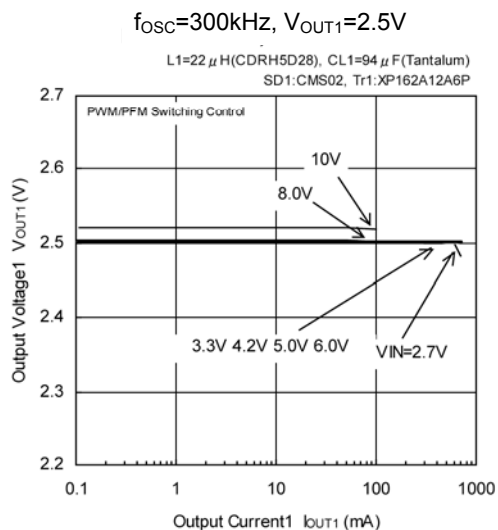
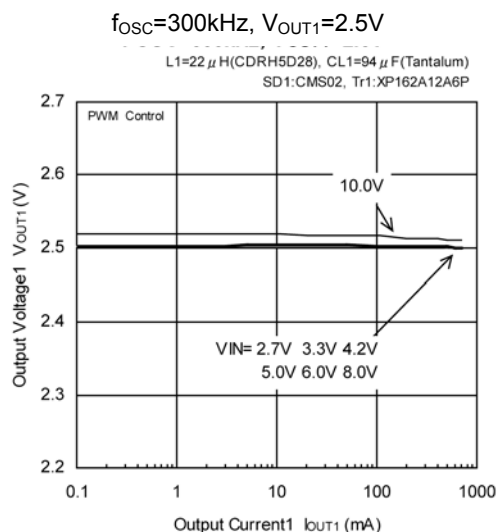
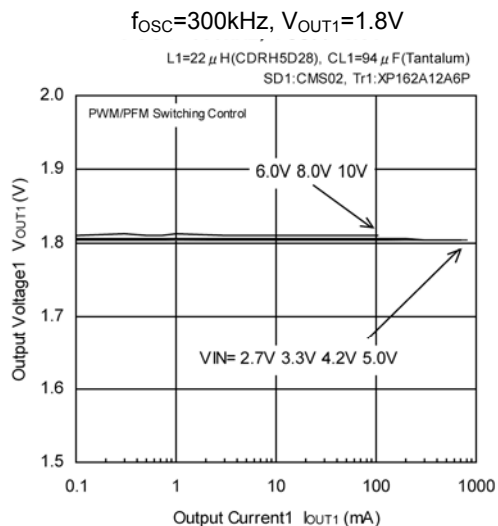
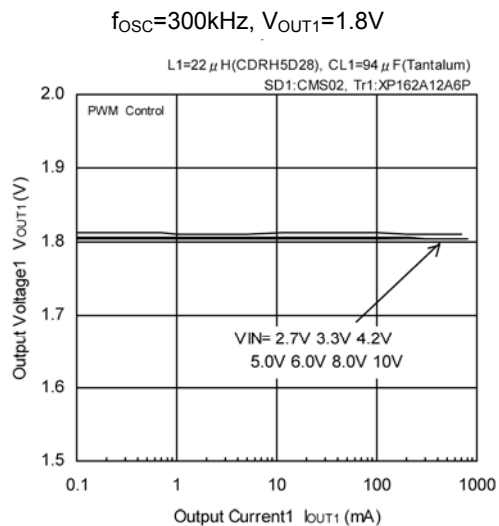

* When setting $V_{OUT1}=1.0V$, $V_{IN}=8.0V$ or $10.0V$
CL=94 μ F (Tantalum) + 100 μ F (OS Capacitor)

■ TYPICAL PERFORMANCE CHARACTERISTICS (Continued)

< 1 ch Step-Down DC/DC Controller > (Continued)

(1) Output Voltage vs. Output Current (Continued)

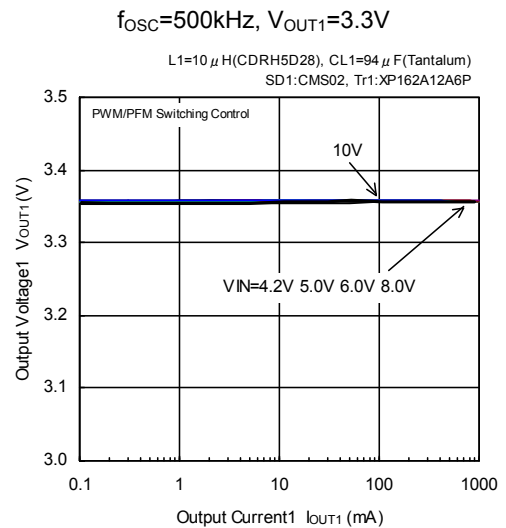
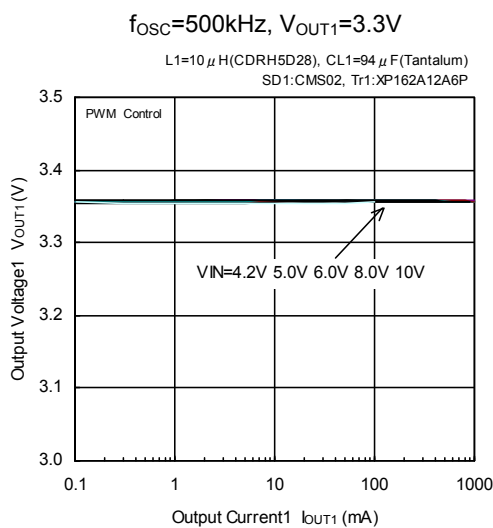
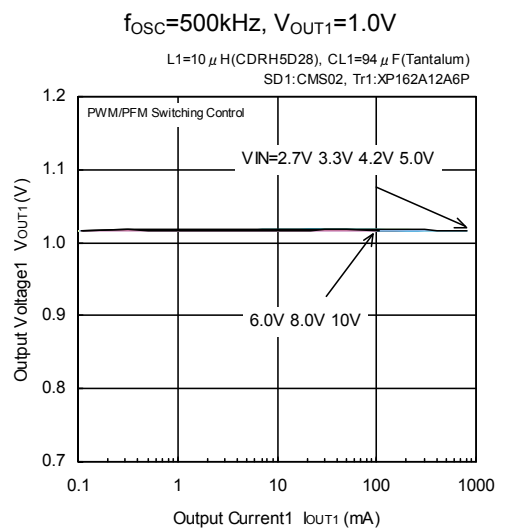
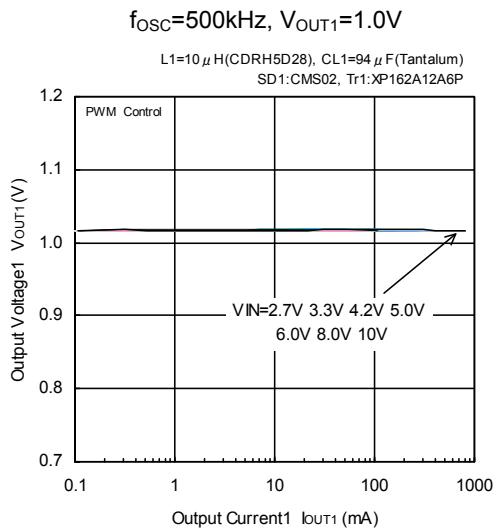
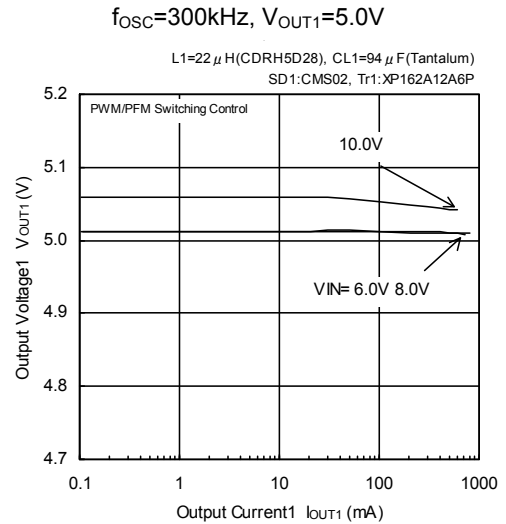
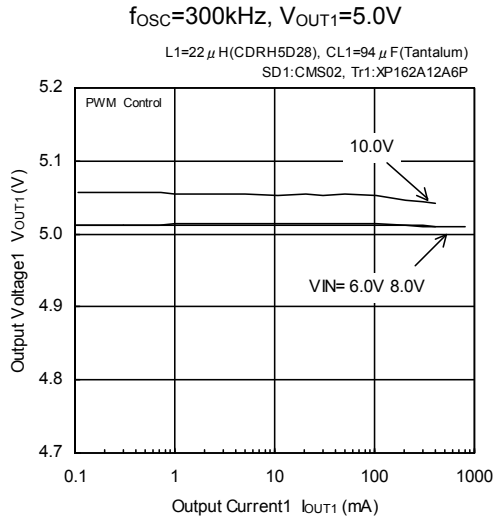

* When setting $V_{OUT1}=1.0V$, $V_{IN}=8.0V$ or $10.0V$,
 $CL=94 \mu$ F (Tantalum) + 100μ F (OS Capacitor)

■ TYPICAL PERFORMANCE CHARACTERISTICS (Continued)

< 1 ch Step-Down DC/DC Controller > (Continued)

(1) Output Voltage vs. Output Current (Continued)

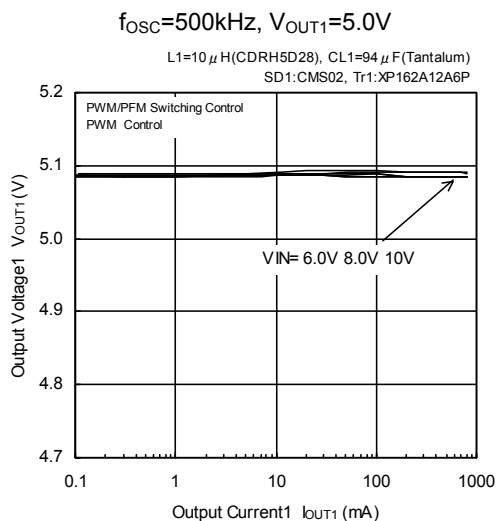

* When setting $V_{OUT1}=1.0V$, $V_{IN}=8.0V$ or $10.0V$,
 $CL=94\mu F$ (Tantalum) + $100\mu F$ (OS Capacitor)

TYPICAL PERFORMANCE CHARACTERISTICS (Continued)

< 1 ch Step-Down DC/DC Controller > (Continued)

(2) Efficiency vs. Output Current

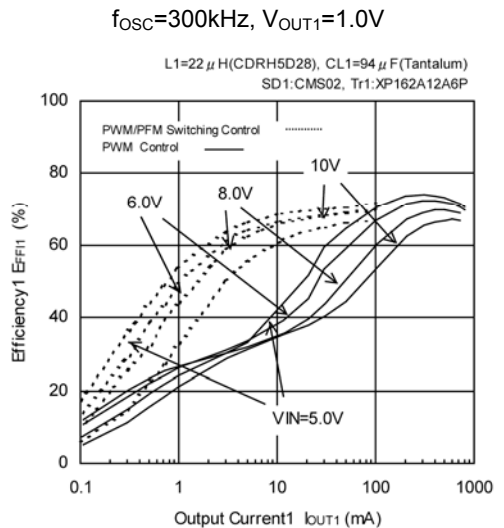
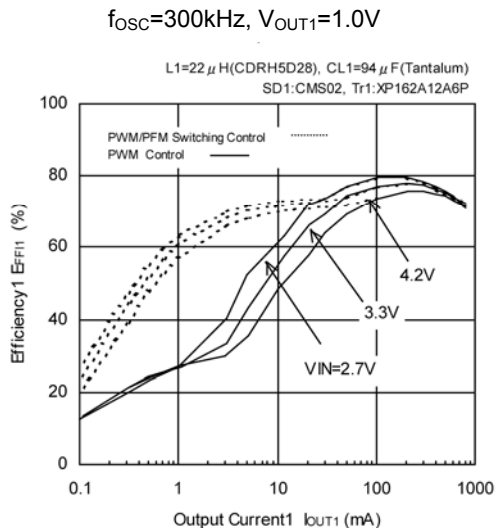
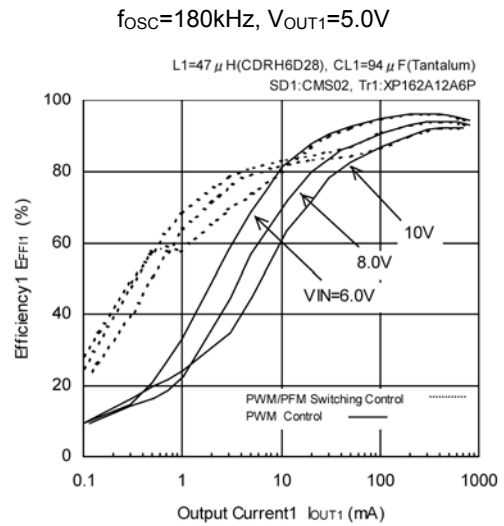
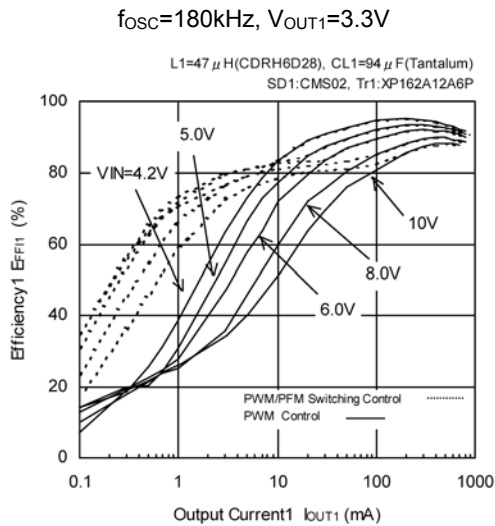
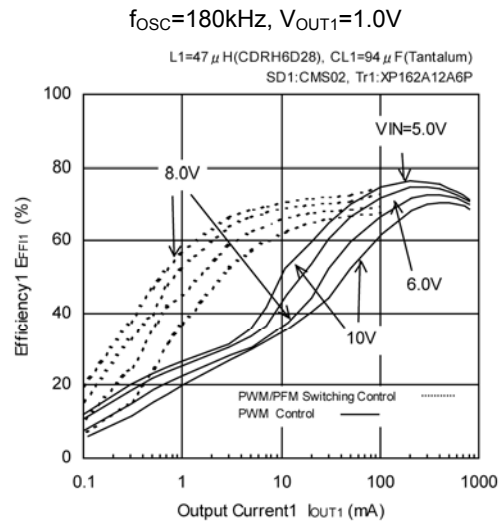
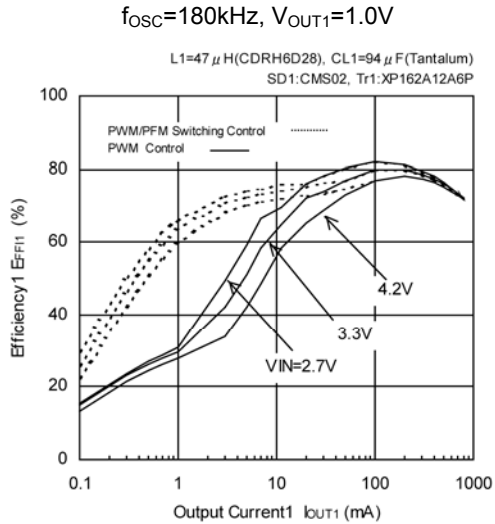

* When setting $V_{OUT1}=1.0V$, $V_{IN}=8.0V$ or $10.0V$,
CL=94 μ F (Tantalum) + 100 μ F (OS Capacitor)

■ TYPICAL PERFORMANCE CHARACTERISTICS (Continued)

< 1 ch Step-Down DC/DC Controller > (Continued)

(2) Efficiency vs. Output Current (Continued)

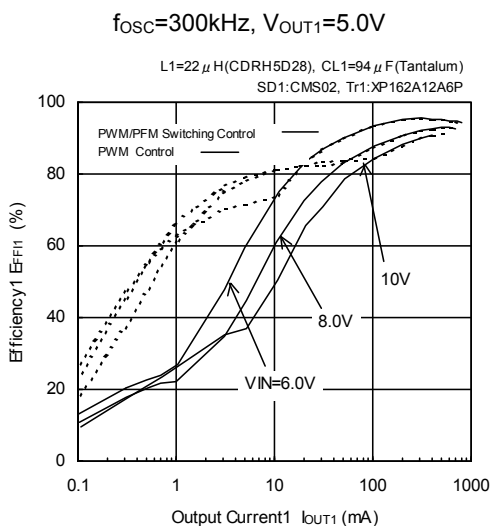
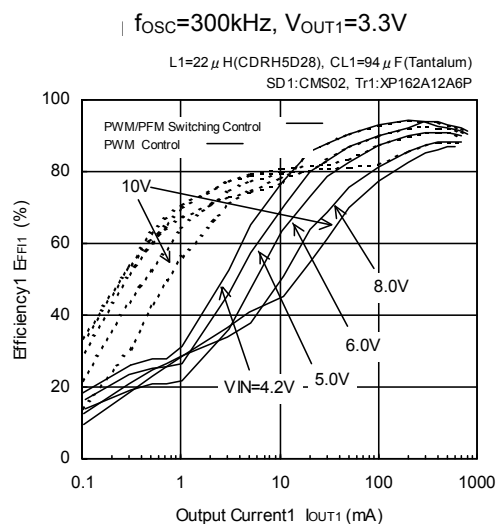
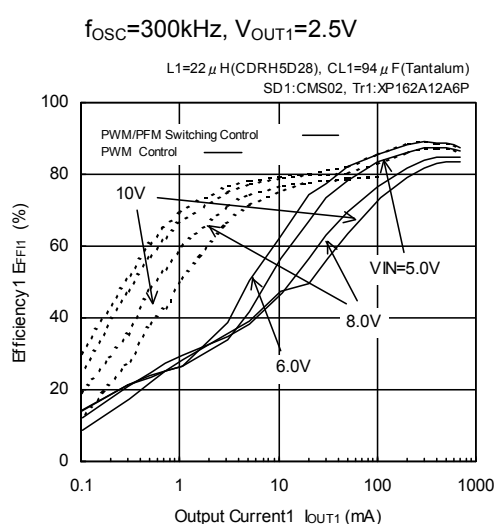
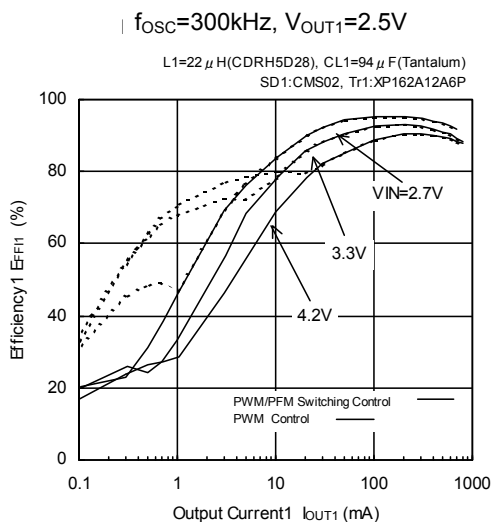
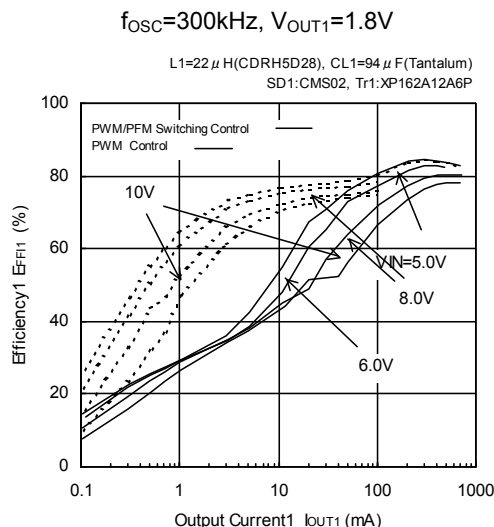
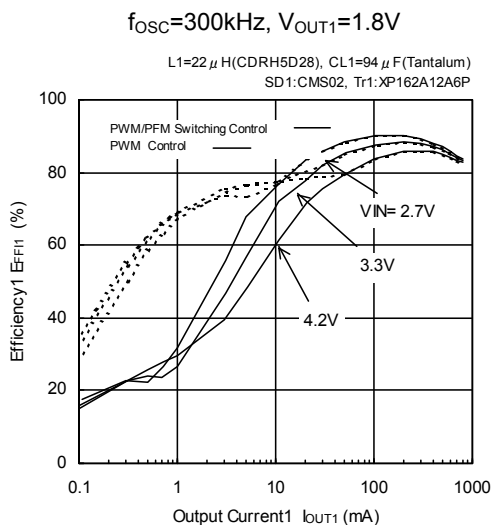

* When setting $V_{OUT1}=1.0V$, $V_{IN}=8.0V$ or $10.0V$,
CL=94 μ F (Tantalum) + 100 μ F (OS Capacitor)

TYPICAL PERFORMANCE CHARACTERISTICS (Continued)

< 1 ch Step-Down DC/DC Controller > (Continued)

(2) Efficiency vs. Output Current (Continued)

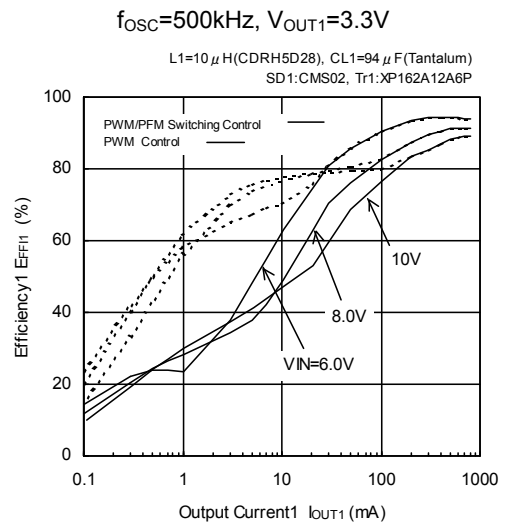
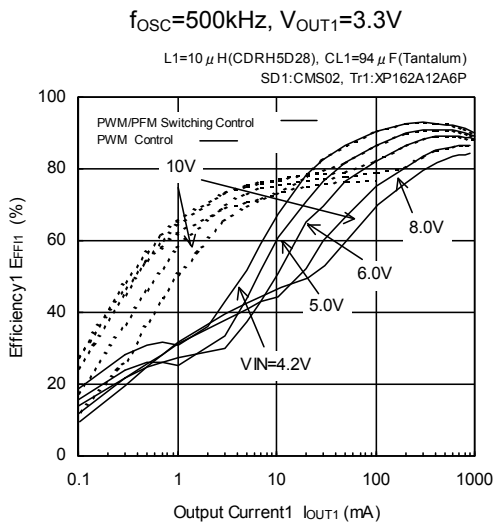
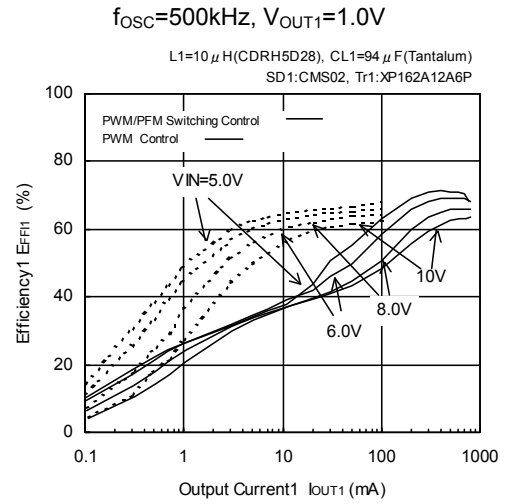
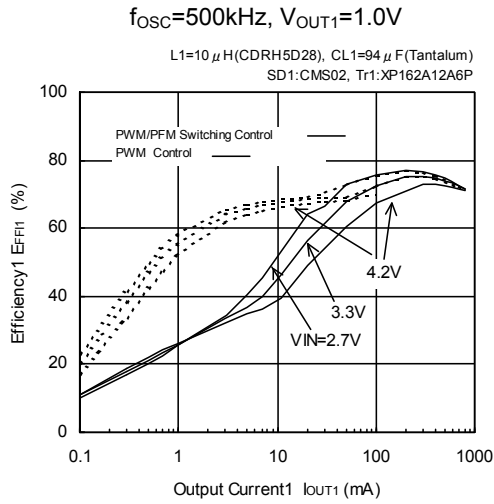

* When setting $V_{OUT1}=1.0V, V_{IN}=8.0V$ or $10.0V,$
 $CL=94\mu F$ (Tantalum) + $100\mu F$ (OS Capacitor)

■ TYPICAL PERFORMANCE CHARACTERISTICS (Continued)

< 1 ch Step-Down DC/DC Controller > (Continued)

(3) Ripple Voltage vs. Output Current

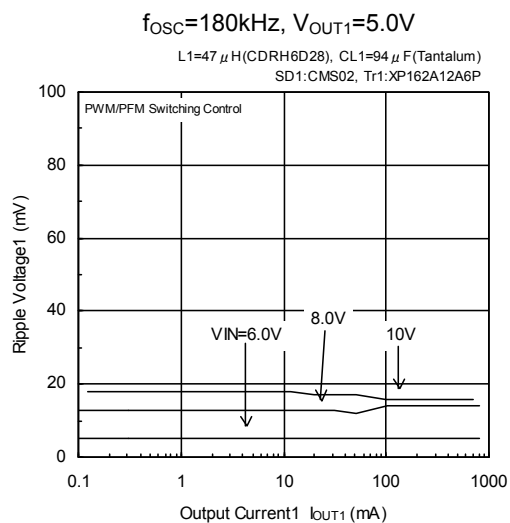
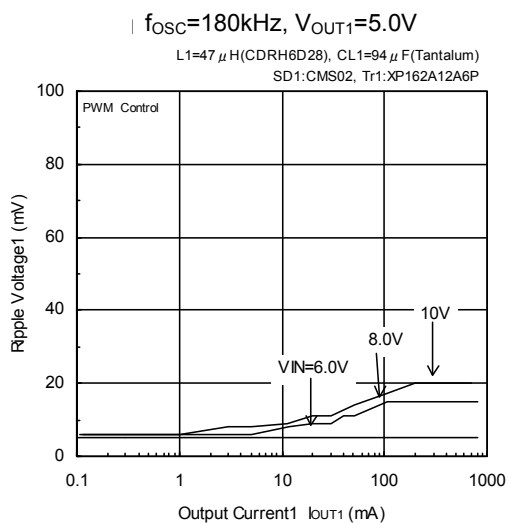
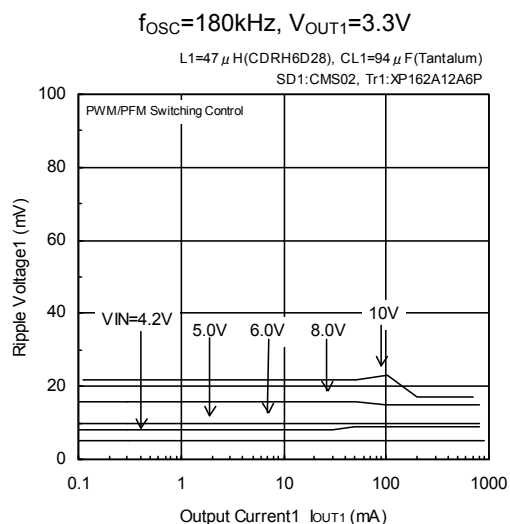
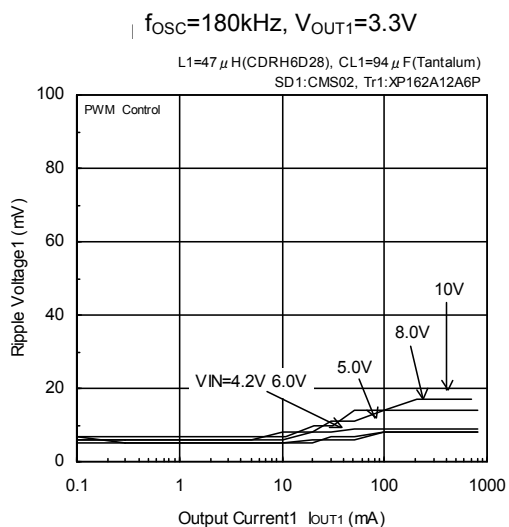
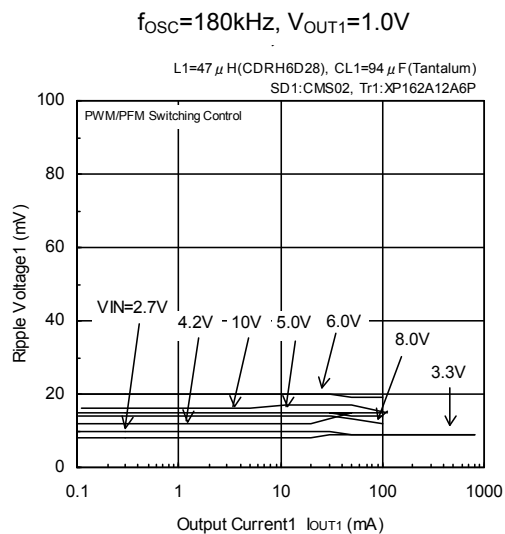
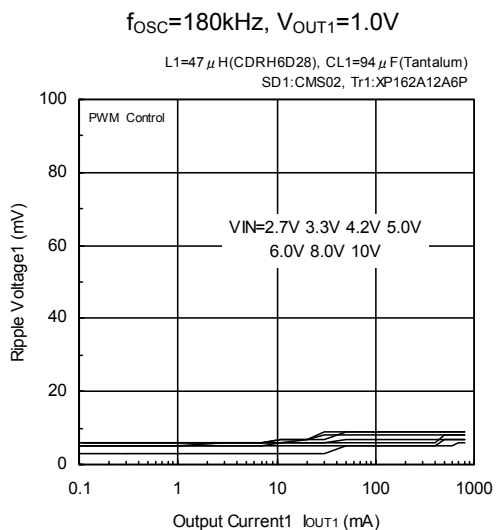

* When setting $V_{OUT1}=1.0V$, $V_{IN}=8.0V$ or $10.0V$,
CL=94 μ F (Tantalum) + 100 μ F (OS Capacitor)

■ TYPICAL PERFORMANCE CHARACTERISTICS (Continued)

< 1 ch Step-Down DC/DC Controller > (Continued)

(3) Ripple Voltage vs. Output Current (Continued)

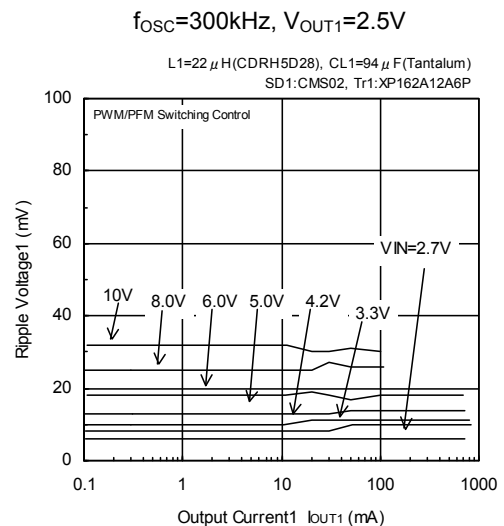
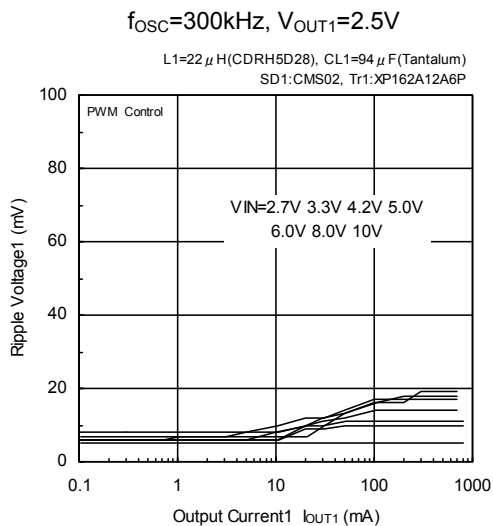
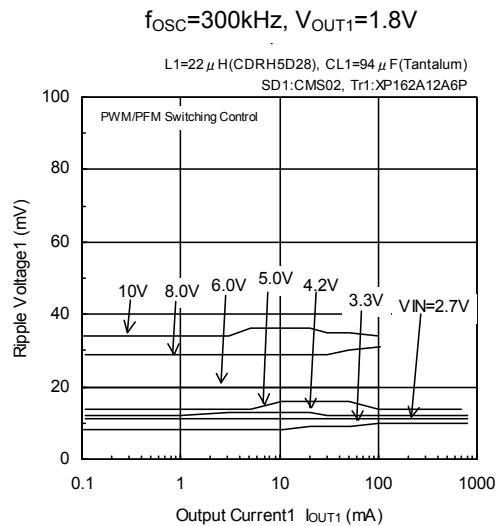
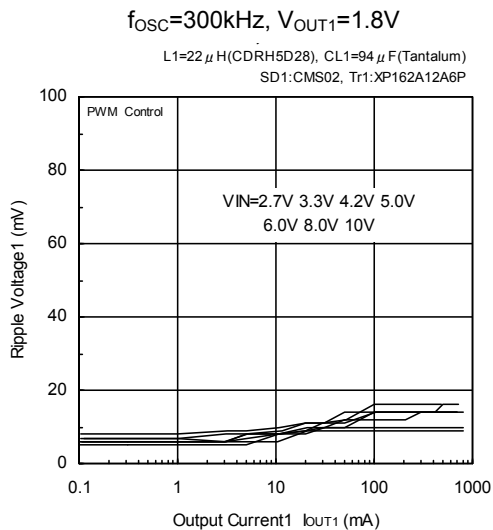
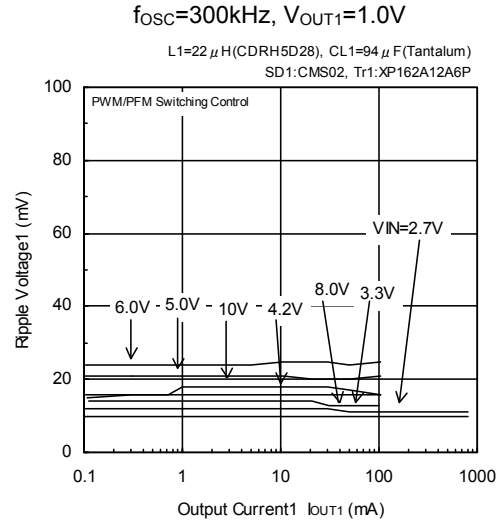
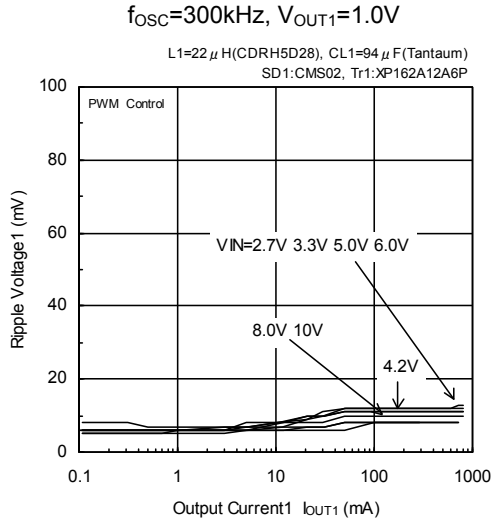

* When setting $V_{OUT1}=1.0V$, $V_{IN}=8.0V$ or $10.0V$,
CL=94 μ F (Tantalum) + 100 μ F (OS Capacitor)

TYPICAL PERFORMANCE CHARACTERISTICS (Continued)

< 1 ch Step-Down DC/DC Controller > (Continued)

(3) Ripple Voltage vs. Output Current (Continued)

$f_{OSC}=300kHz, V_{OUT1}=3.3V$

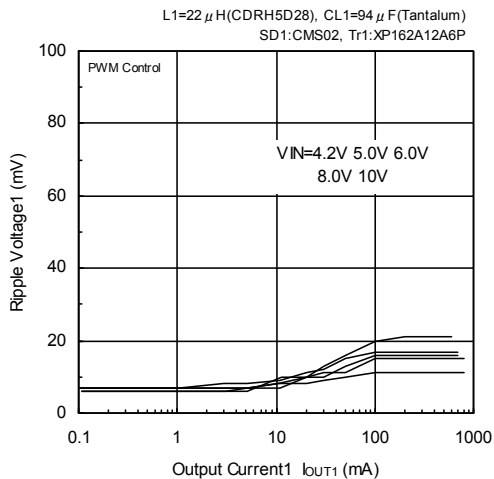

$f_{OSC}=300kHz, V_{OUT1}=3.3V$

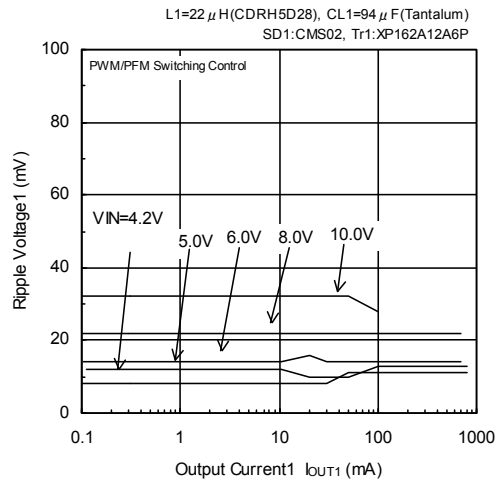

$f_{OSC}=300kHz, V_{OUT1}=5.0V$

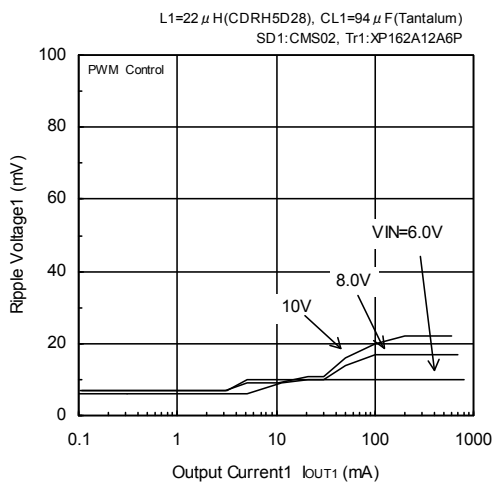

$f_{OSC}=300kHz, V_{OUT1}=5.0V$

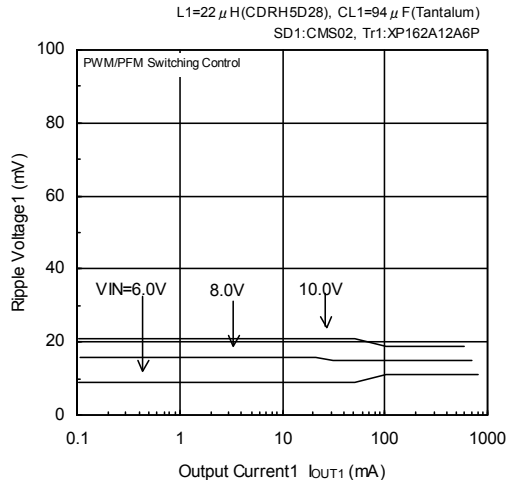

$f_{OSC}=500kHz, V_{OUT1}=1.0V$

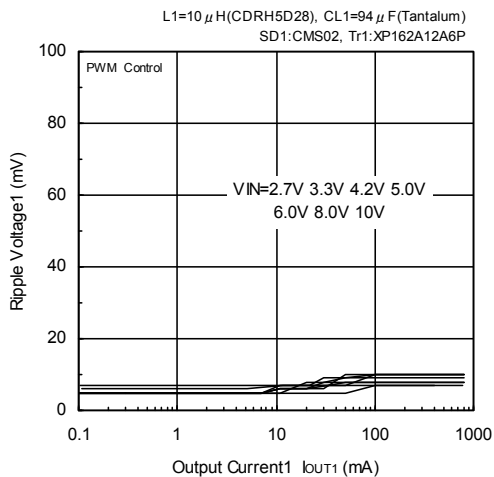

$f_{OSC}=500kHz, V_{OUT1}=1.0V$

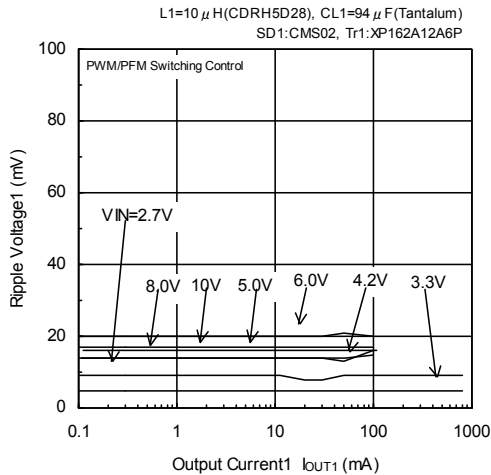

* When setting $V_{OUT1}=1.0V$, $V_{IN}=8.0V$ or $10.0V$,
CL=94 μ F (Tantalum) + 100 μ F (OS Capacitor)

TYPICAL PERFORMANCE CHARACTERISTICS (Continued)

< 1 ch Step-Down DC/DC Controller > (Continued)

(3) Ripple Voltage vs. Output Current (Continued)

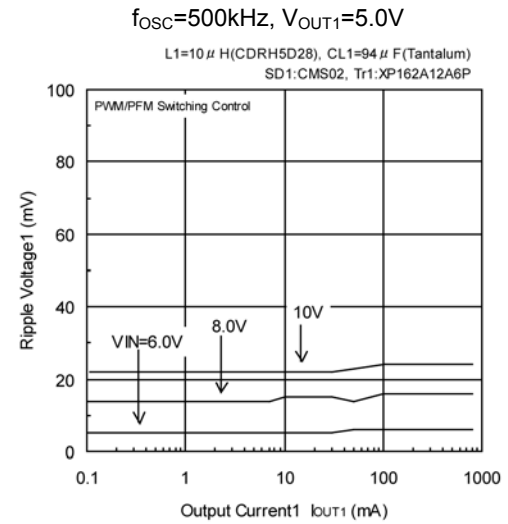
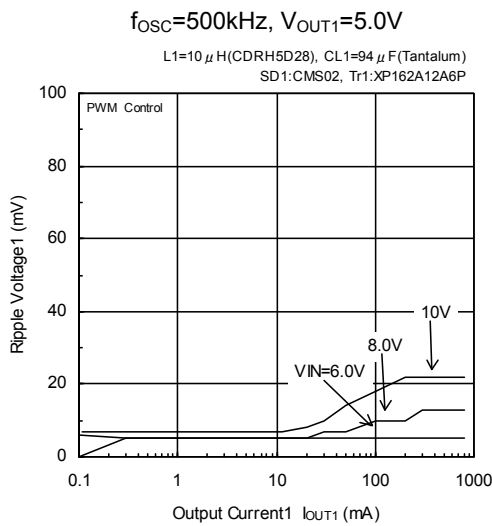
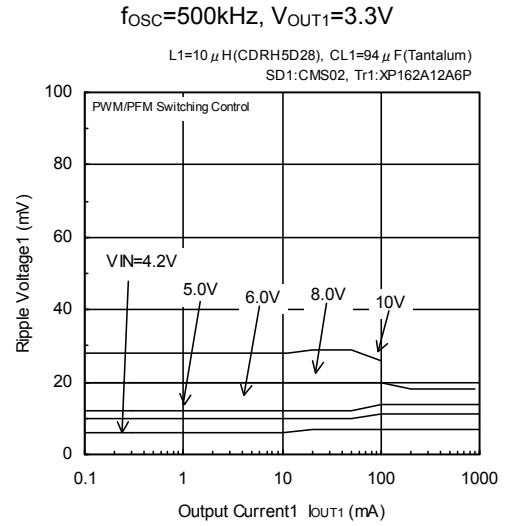
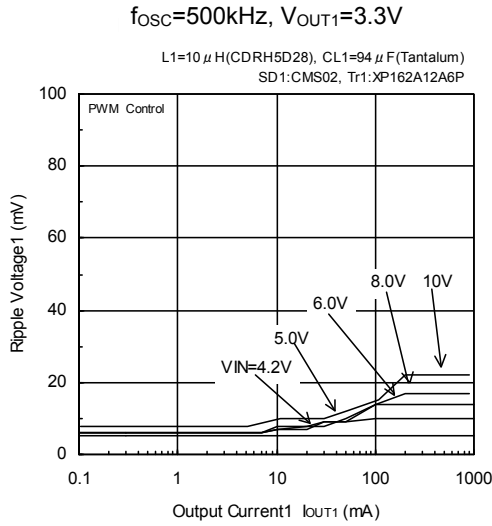

* When setting $V_{OUT1}=1.0V$, $V_{IN}=8.0V$ or $10.0V$,
 $C_L=94 \mu F$ (Tantalum) + $100 \mu F$ (OS Capacitor)

■ TYPICAL PERFORMANCE CHARACTERISTICS (Continued)

< 2 ch. Inverting DC/DC Controller >

(4) Output Voltage vs. Output Current

<Ceramic capacitor and compact inductor use>

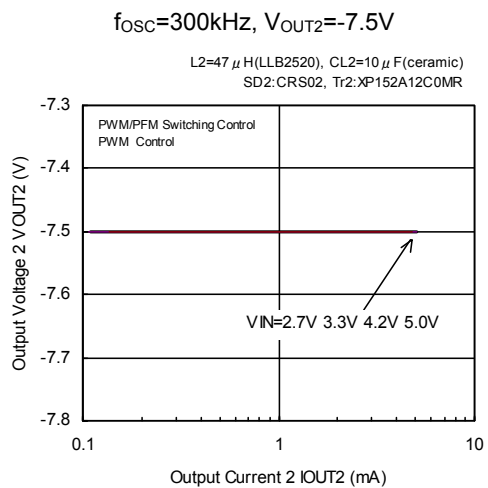
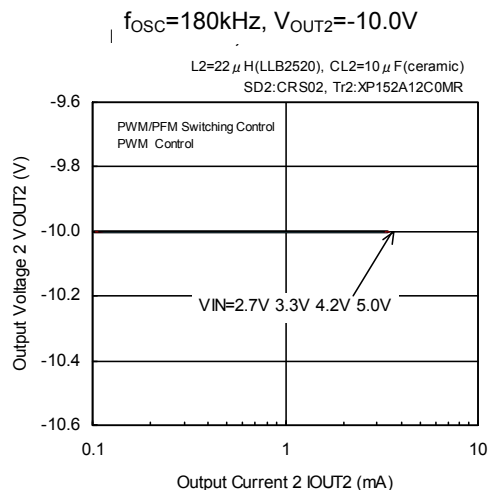
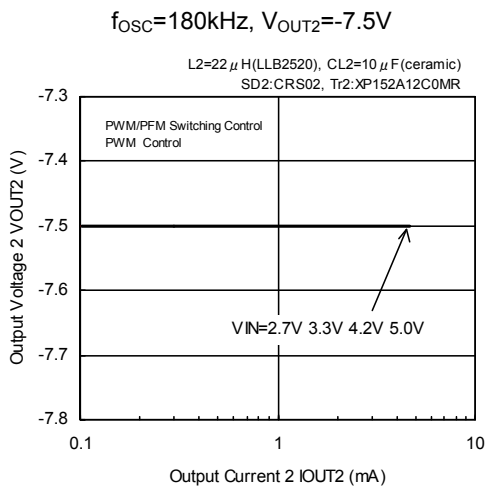

TYPICAL PERFORMANCE CHARACTERISTICS (Continued)

< 2 ch. Inverting DC/DC Controller > (Continued)

(4) Output Voltage vs. Output Current (Continued)

<Ceramic capacitor use>

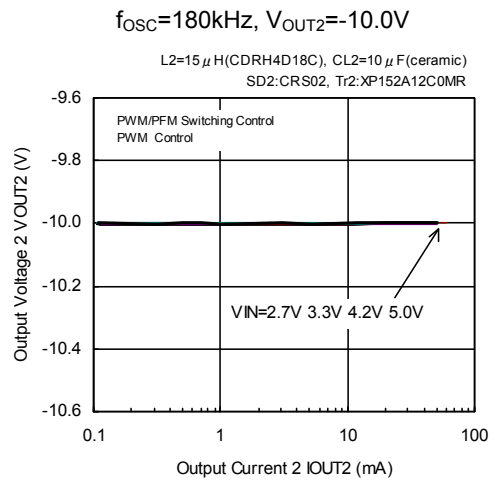
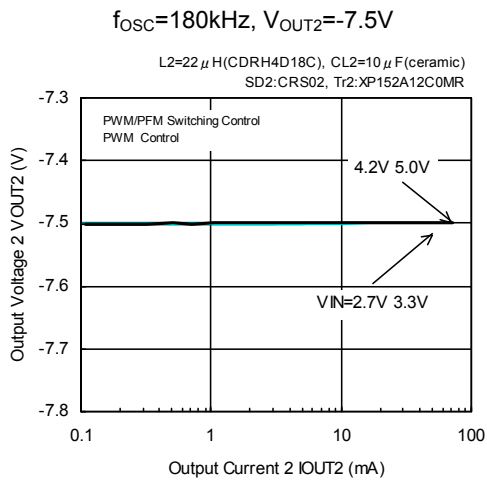
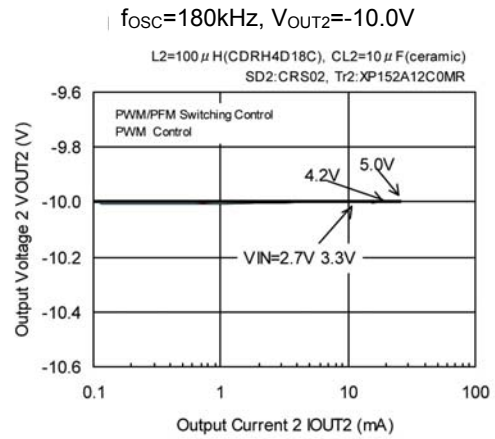
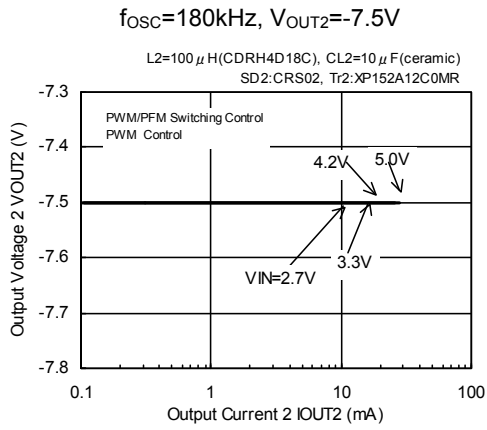

TYPICAL PERFORMANCE CHARACTERISTICS (Continued)

< 2 ch. Inverting DC/DC Controller > (Continued)

(4) Output Voltage vs. Output Current (Continued)

<Ceramic capacitor use>

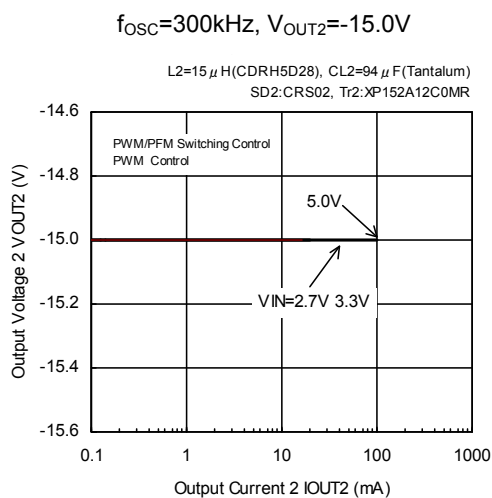
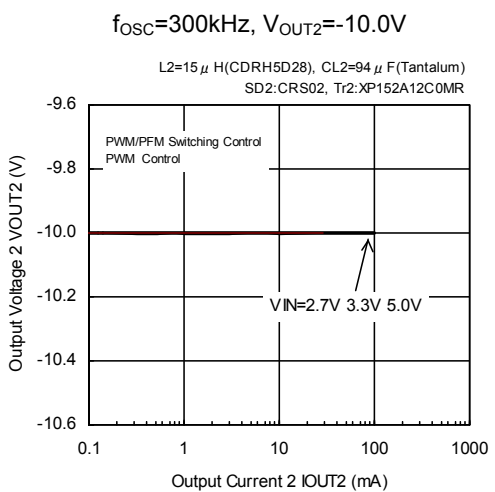
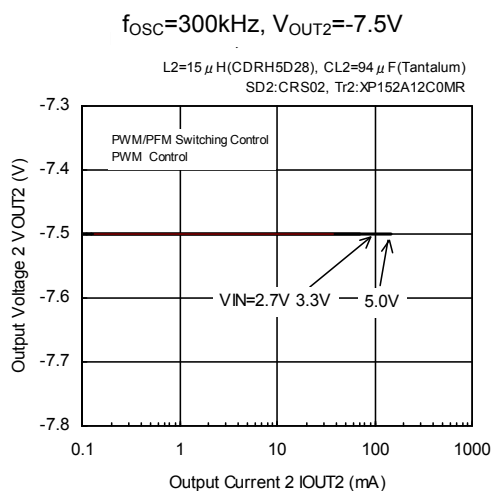
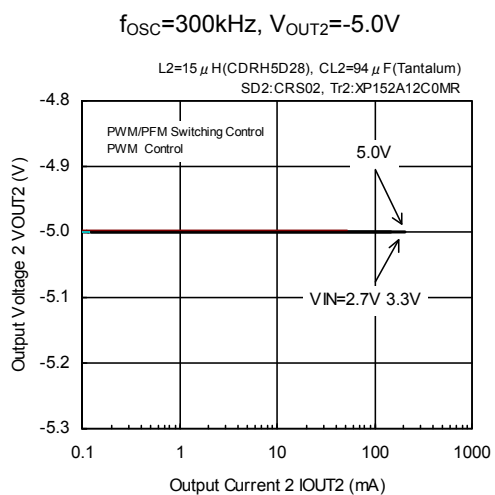
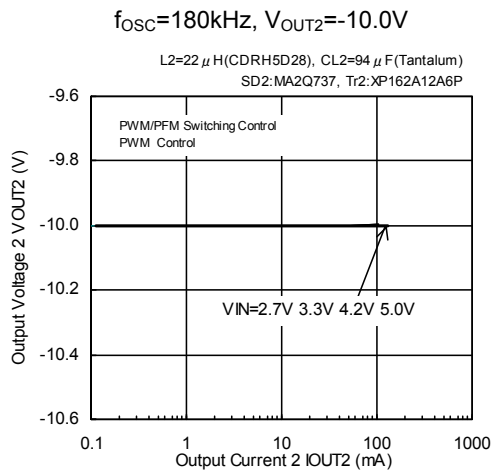
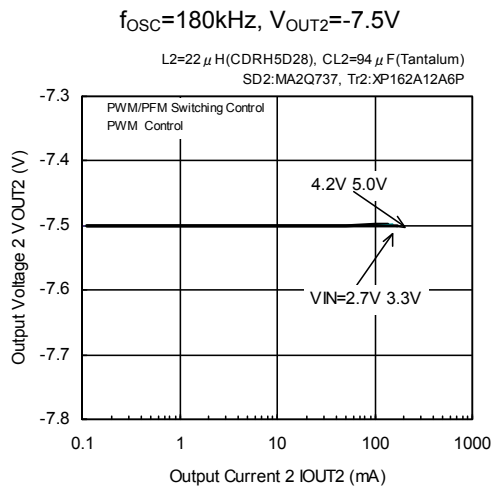

■ TYPICAL PERFORMANCE CHARACTERISTICS (Continued)

< 2 ch. Inverting DC/DC Controller > (Continued)

(5) Efficiency vs. Output Current

<Ceramic capacitor and compact inductor use>

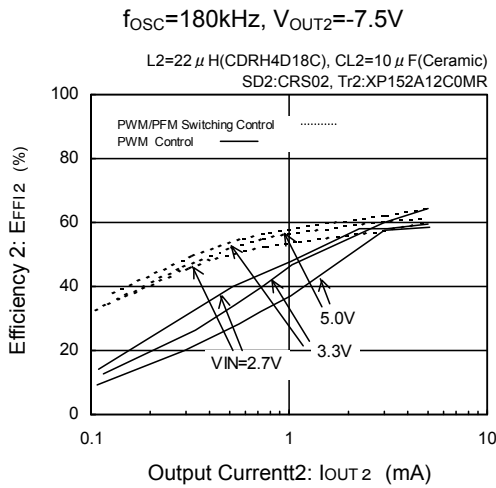
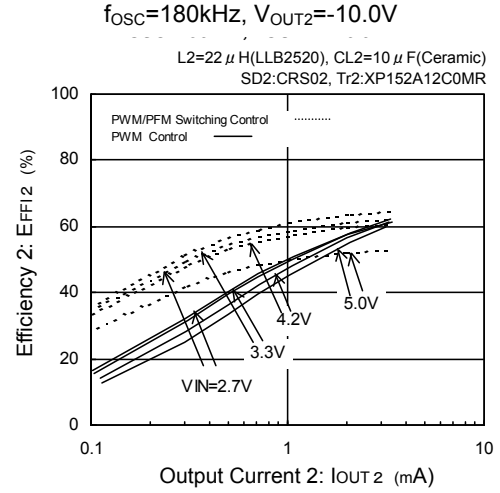
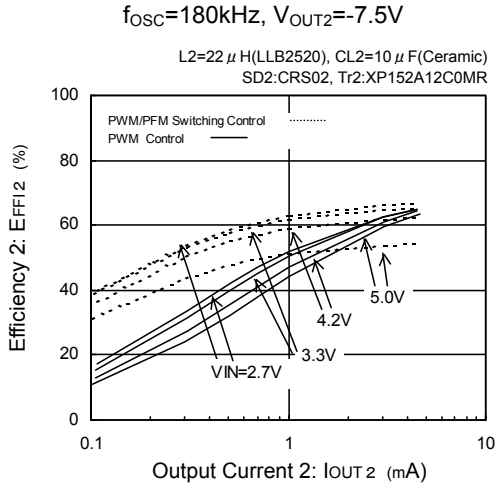

TYPICAL PERFORMANCE CHARACTERISTICS (Continued)

< 2 ch. Inverting DC/DC Controller > (Continued)

(5) Efficiency vs. Output Current (Continued)

<Ceramic capacitor use>

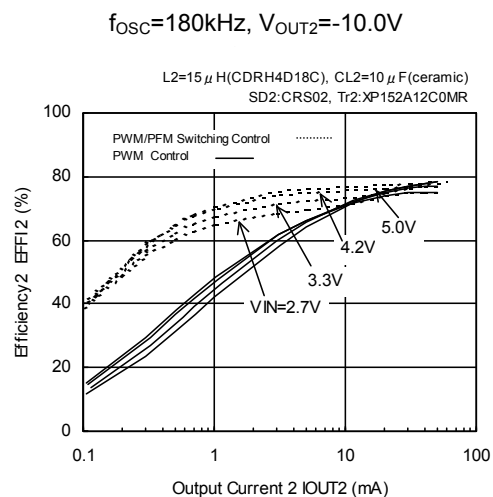
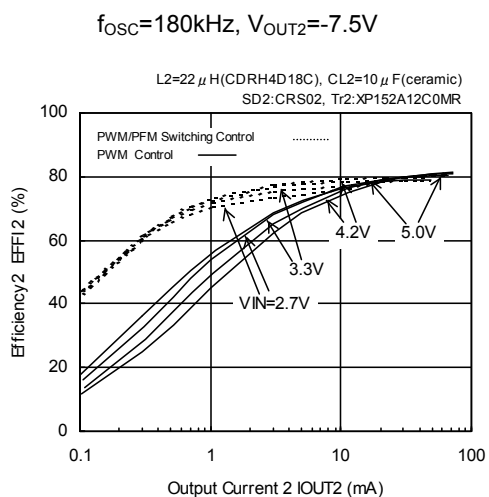
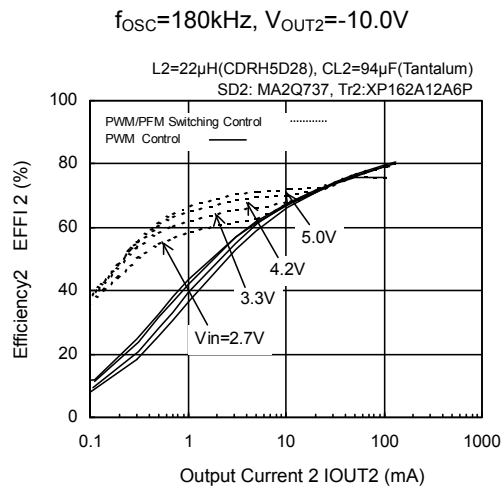
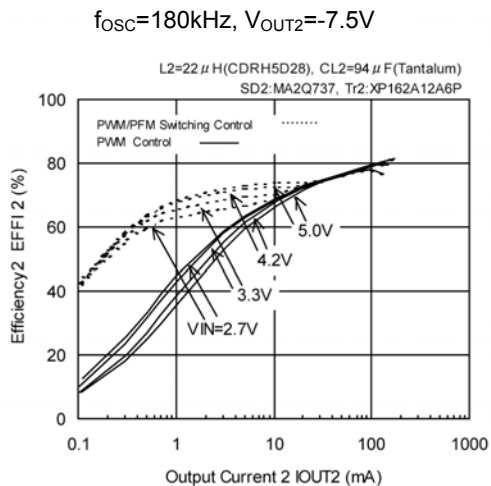

■ TYPICAL PERFORMANCE CHARACTERISTICS (Continued)

< 2 ch. Inverting DC/DC Controller > (Continued)

(5) Efficiency vs. Output Current (Continued)

<Tantalum capacitor use>

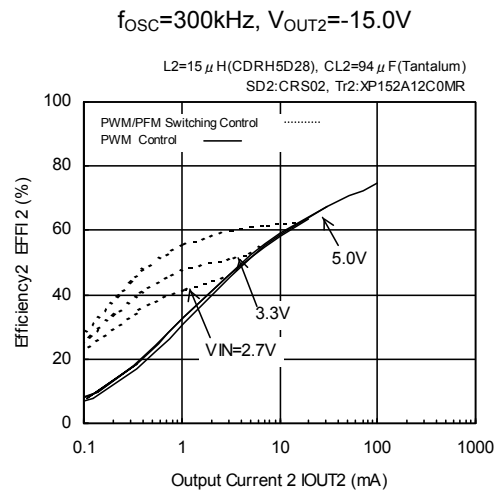
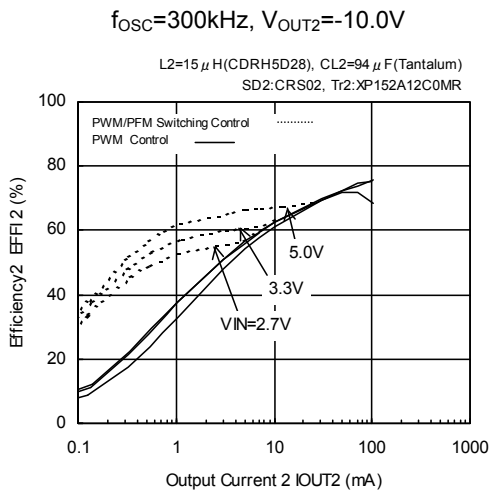
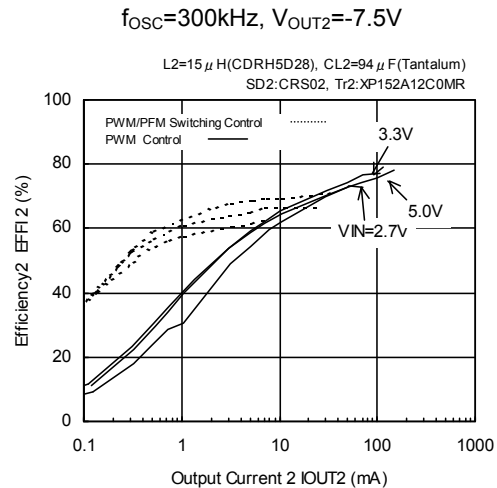
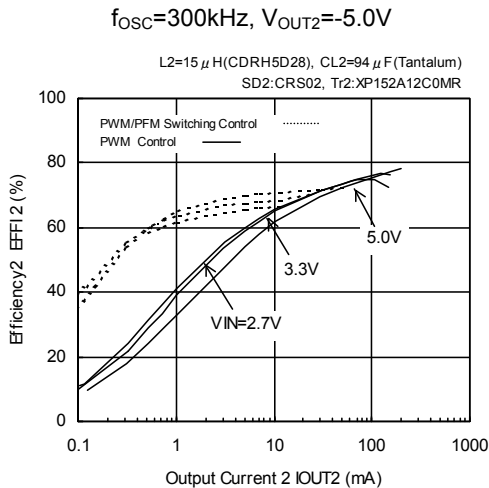
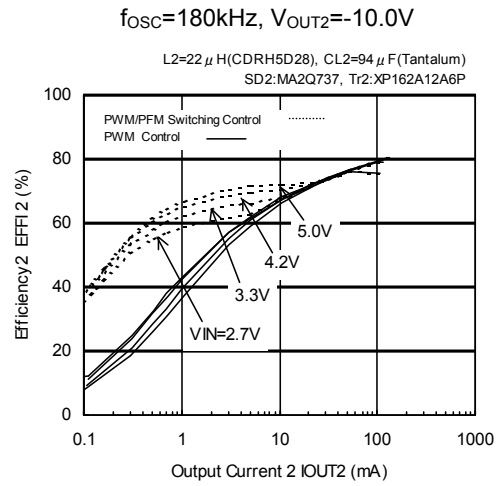
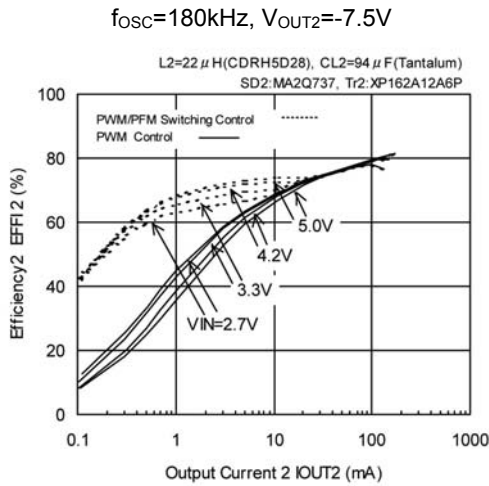

■ TYPICAL PERFORMANCE CHARACTERISTICS (Continued)

< 2 ch. Inverting DC/DC Controller > (Continued)

(6) Ripple Voltage vs. Output Current

<Ceramic capacitor and compact inductor use>

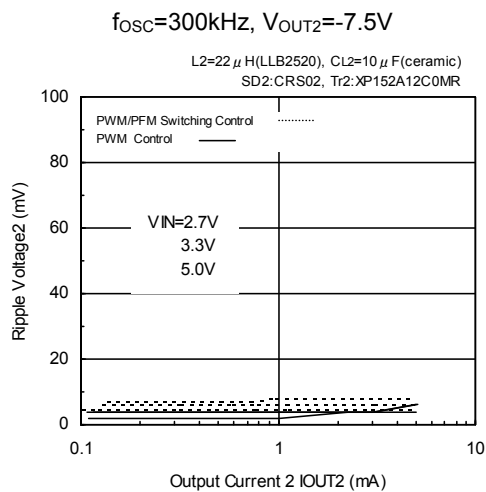
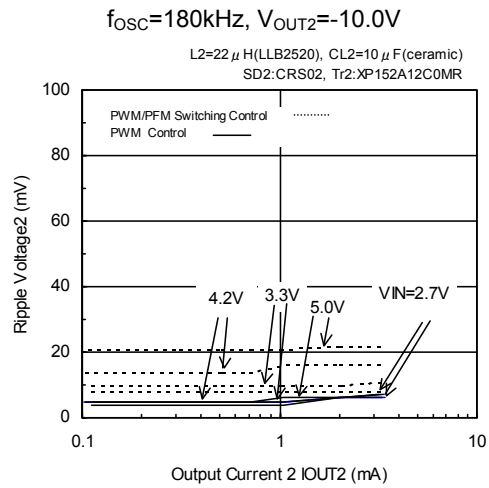
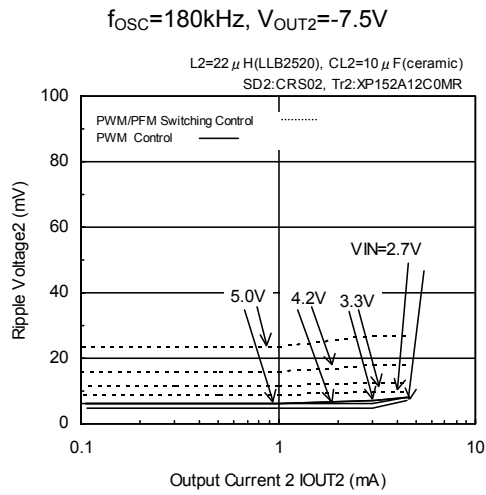

TYPICAL PERFORMANCE CHARACTERISTICS (Continued)

< 2 ch. Inverting DC/DC Controller > (Continued)

(6) Ripple Voltage vs. Output Current (Continued)

<Ceramic capacitor use>

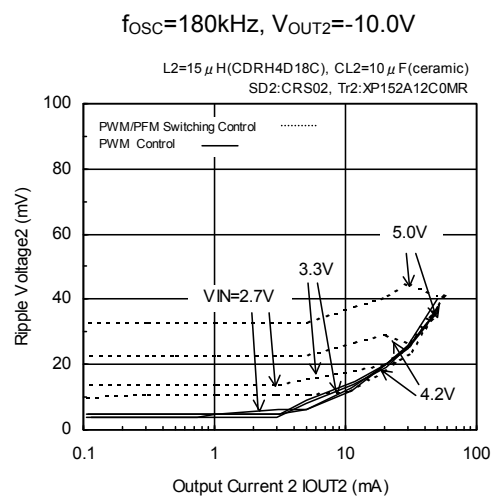
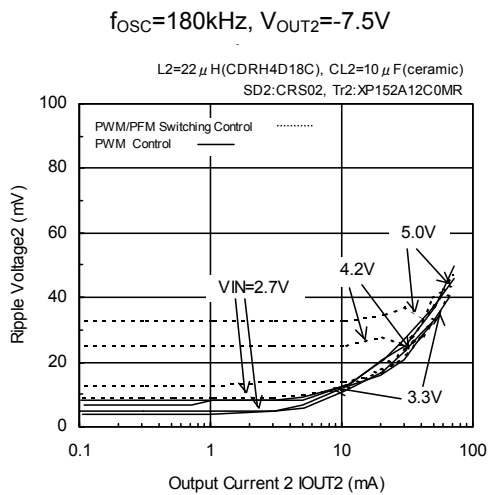
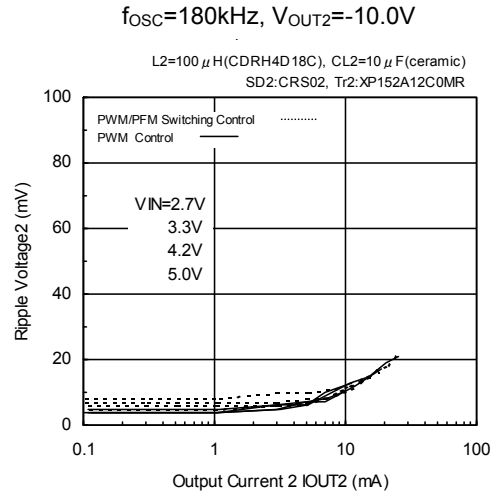
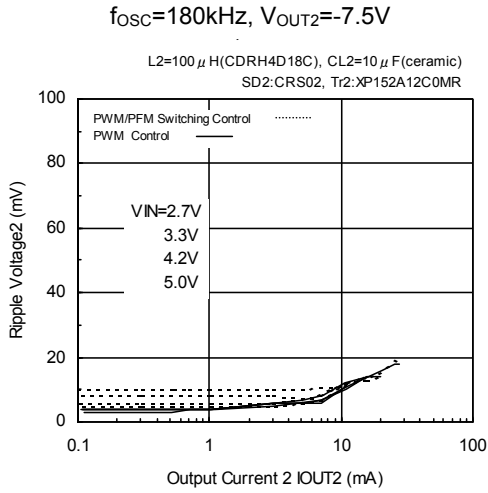

TYPICAL PERFORMANCE CHARACTERISTICS (Continued)

< 2 ch. Inverting DC/DC Controller > (Continued)

(6) Ripple Voltage vs. Output Current (Continued)

<Tantalum capacitor use>

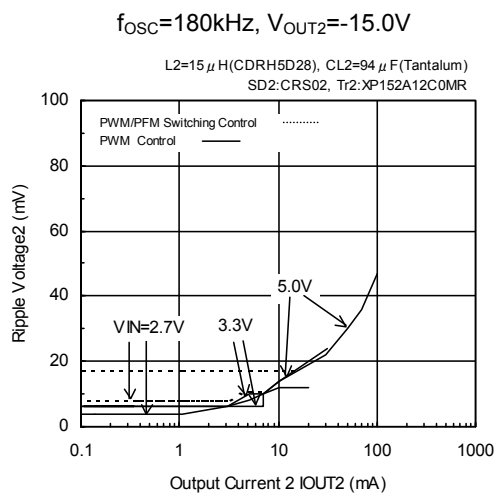
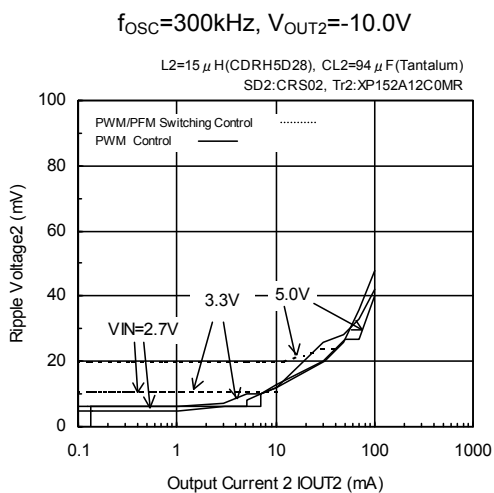
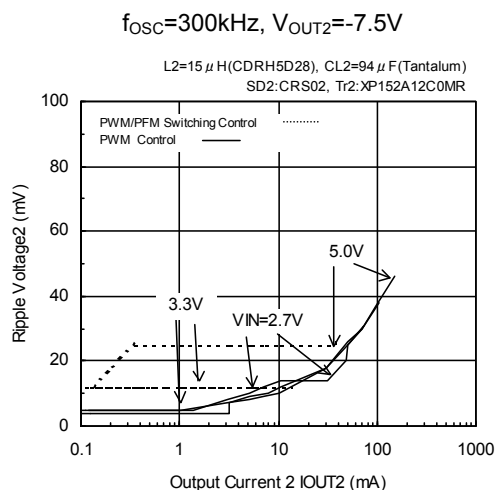
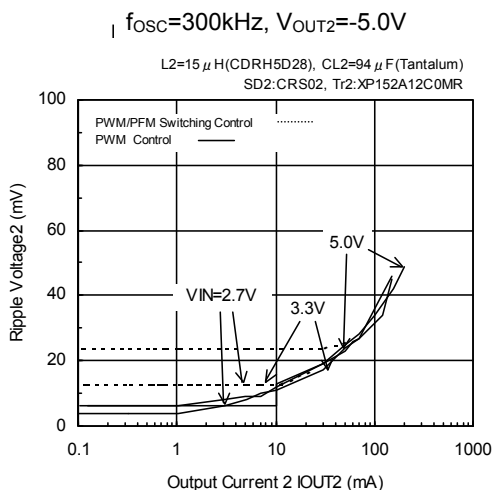
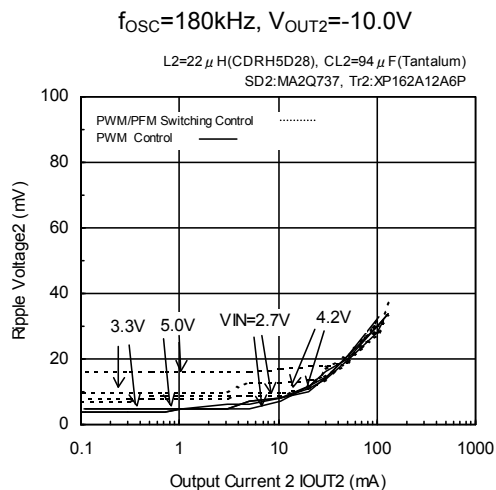
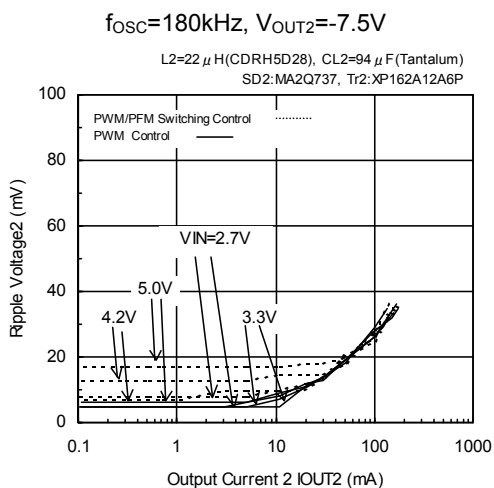

TYPICAL PERFORMANCE CHARACTERISTICS (Continued)

< 2 ch. Inverting DC/DC Controller > (Continued)

(7) Breakdown of Output Voltage

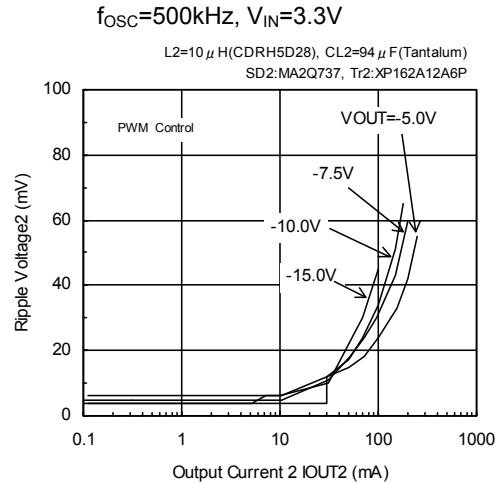
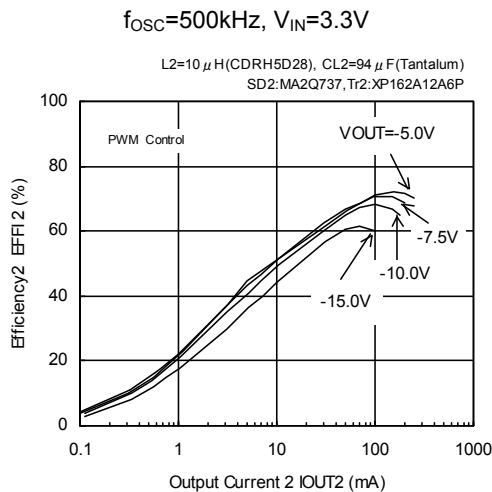
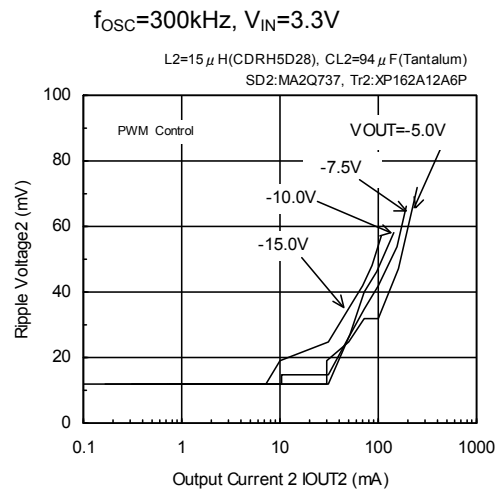
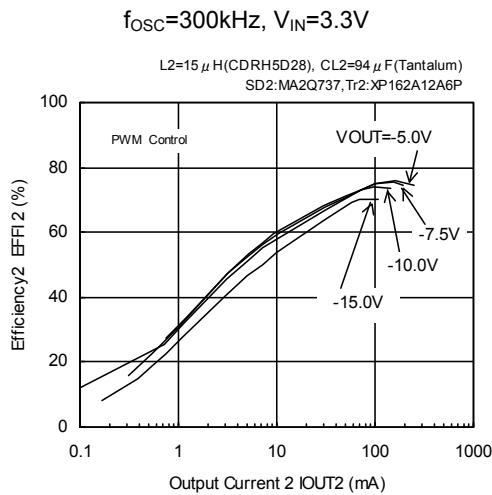
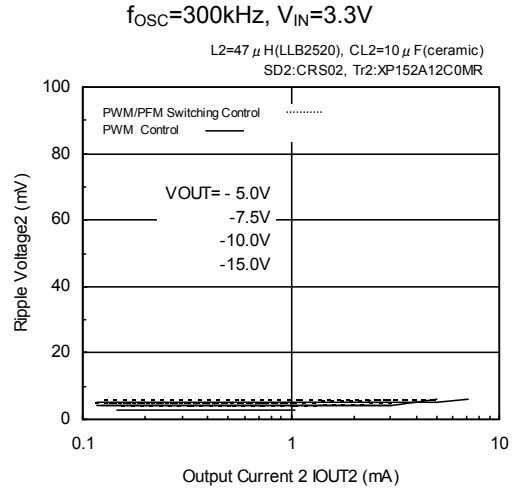
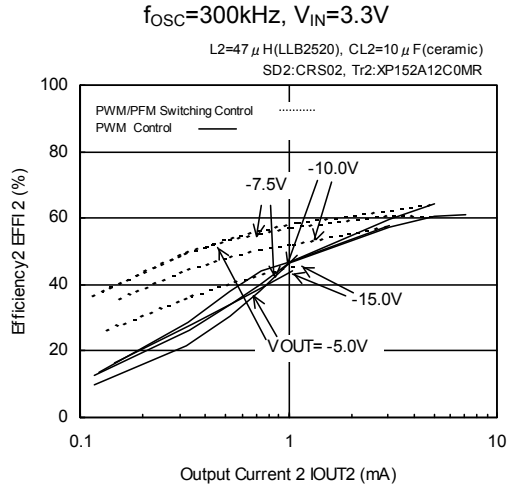

■ TYPICAL PERFORMANCE CHARACTERISTICS (Continued)

< 2 ch. Inverting DC/DC Controller > (Continued)

(8) Breakdown of Coil Inductance Value

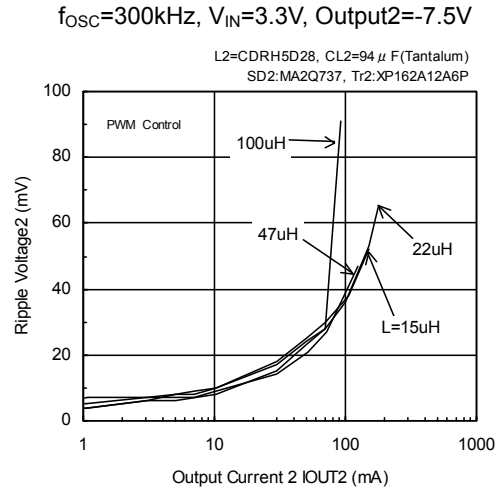
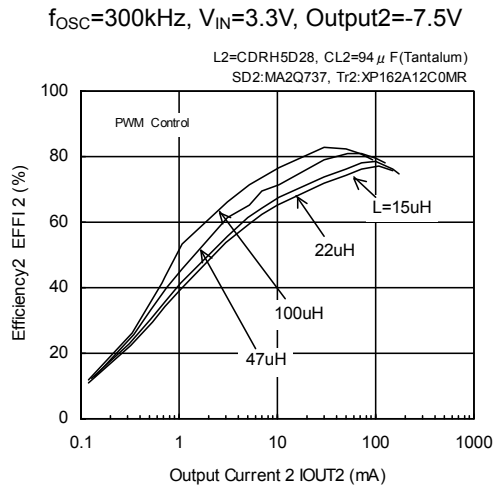

TYPICAL PERFORMANCE CHARACTERISTICS (Continued)

(9) Supply Current 1 vs. Supply Voltage

XC9505B092 (180KHz)

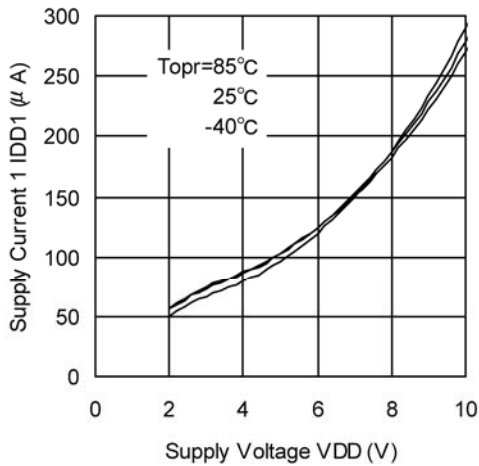

(10) Supply Current 1-1 vs. Supply Voltage

XC9505B092 (180KHz)

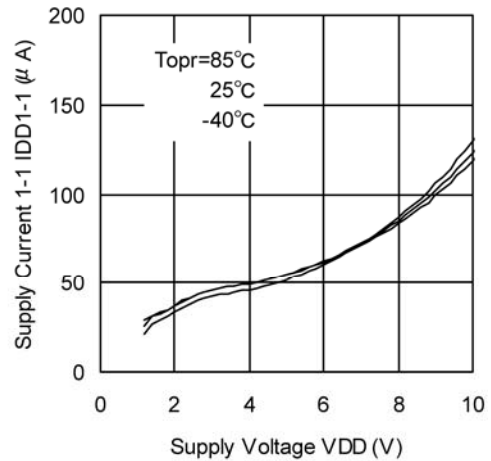

(11) Supply Current 1-2 vs. Supply Voltage

XC9505B092 (180KHz)

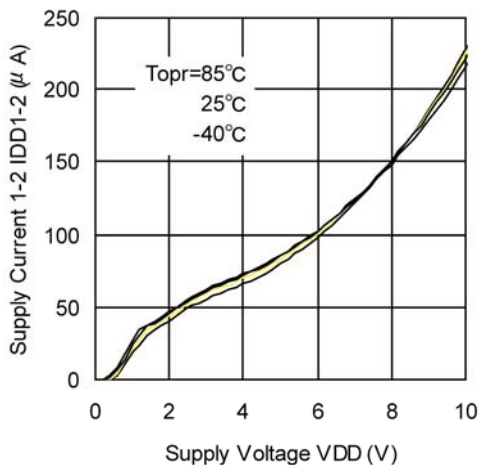

(12) Supply Current 1-3 vs. Supply Voltage

XC9505B095 (180KHz)

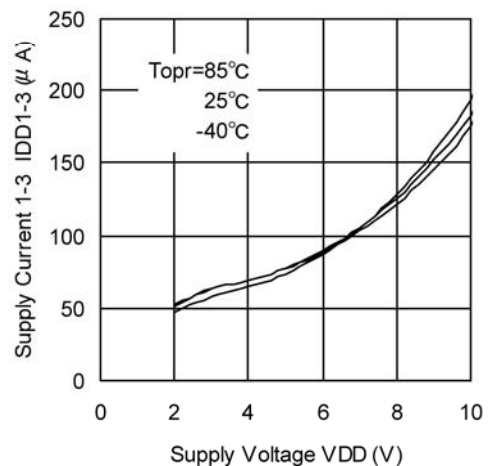

(13) Supply Current 1-4 vs. Supply Voltage

XC9505B092 (180KHz)

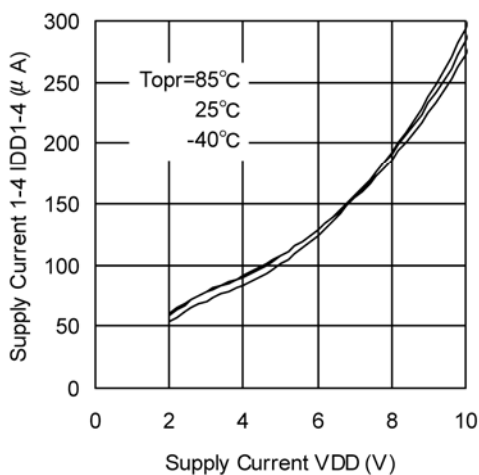

(14) Supply Current 2 vs. Supply Voltage

XC9505B092 (180KHz)

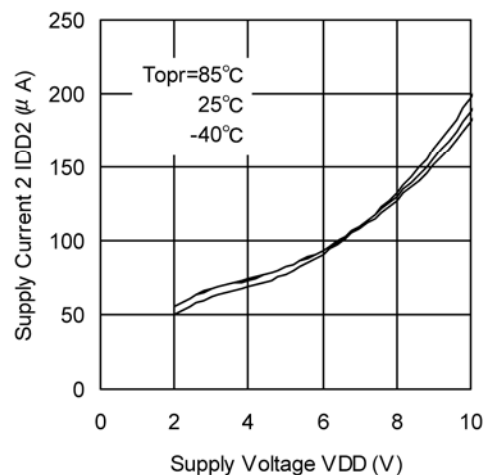

TYPICAL PERFORMANCE CHARACTERISTICS (Continued)

(15) Stand-by Current vs. Supply Voltage

XC9505B092 (180kHz)

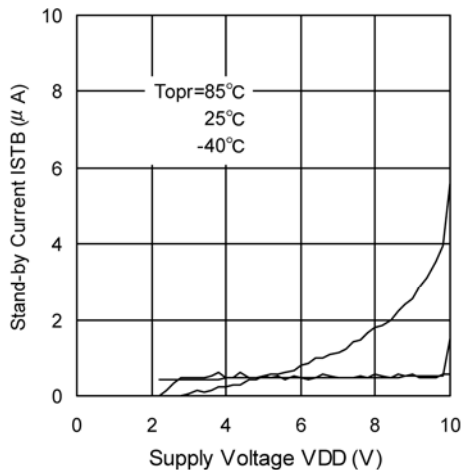

(16) Oscillation Frequency vs. Supply Voltage

XC9505B092 (180kHz)

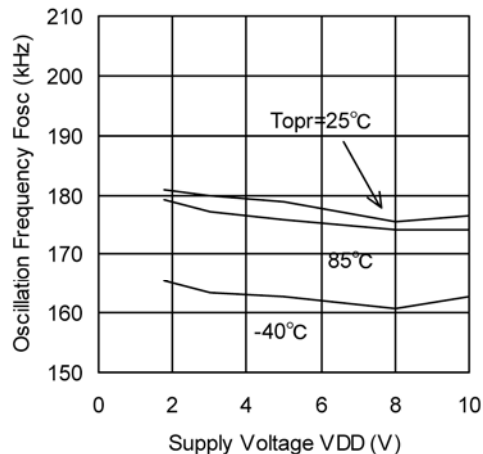

(17) PWM1, 2 'H' 'L' Voltage vs. Supply Voltage

XC9505B092 (180kHz)

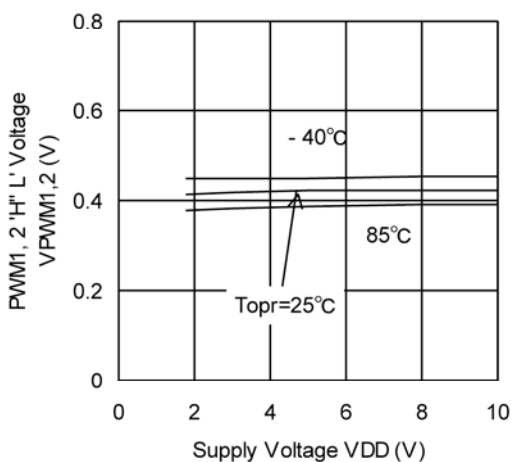

(18) EN1, 2 'H' 'L' Voltage vs. Supply Voltage

XC9505B092 (180kHz)

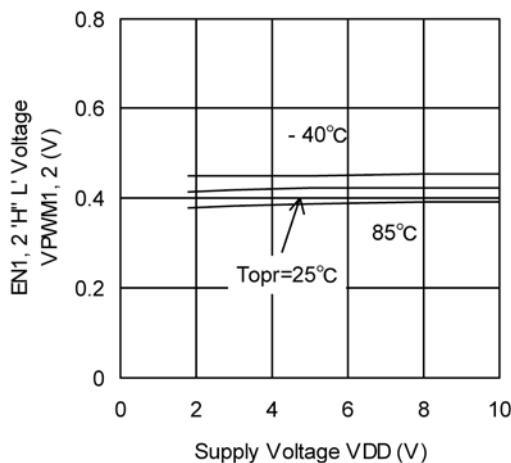

(19) MAX. Duty Ratio 2 vs. Supply Voltage

XC9505B092 (180kHz)

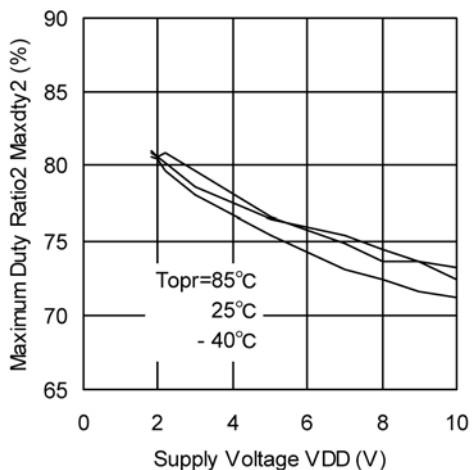

(20) Soft-start Time vs. Supply Voltage

XC9505B092 (180kHz)

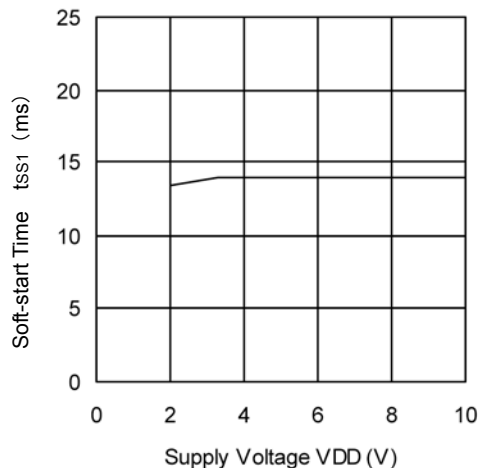

TYPICAL PERFORMANCE CHARACTERISTICS (Continued)

(21) EXT1, 2 High ON Resistance vs. Supply Voltage

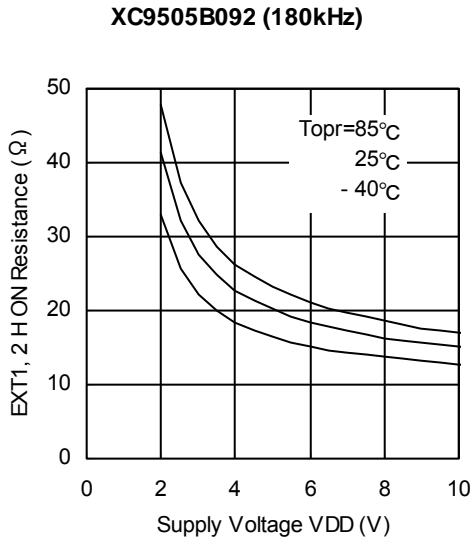

(22) EXT1, 2 Low ON Resistance vs. Supply Voltage

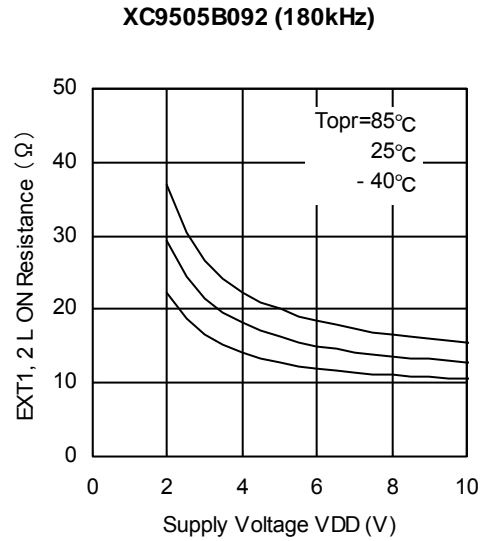

(23) Output Voltage vs. Ambient Temperature

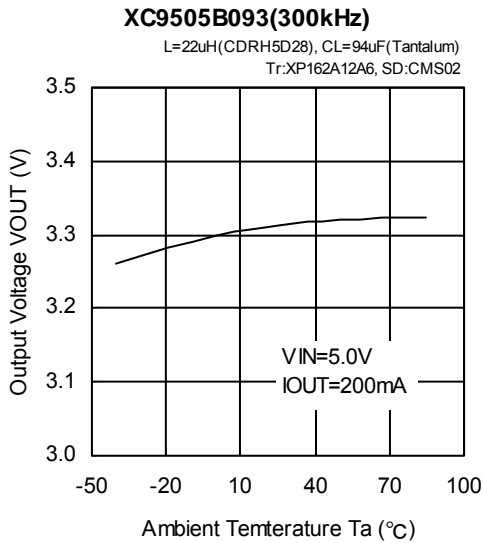

(24) PFM Duty Ratio1, 2 vs. Supply Voltage

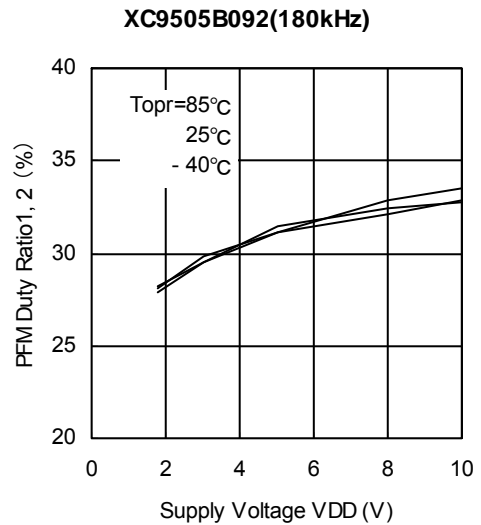

■ TYPICAL PERFORMANCE CHARACTERISTICS (Continued)

< 1 ch. Step-Up DC/DC Controller >

(25) Load Transient Response

< $V_{OUT1} = 3.3V$, $V_{IN} = 5.0V$, $I_{OUT1} = 100\mu A \leftrightarrow 300mA$ >

● PWM Control

$f_{OSC} = 300kHz$, $V_{OUT1} = 3.3V$
 $V_{IN} = 5.0V$, $I_{OUT1} = 100\mu A \rightarrow 300mA$

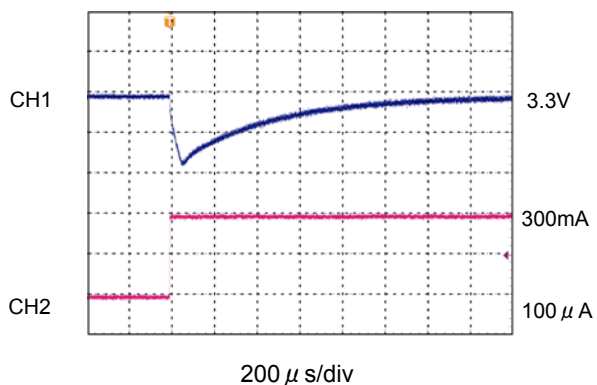

CH1: V_{OUT1} , AC-COUPLED, 100mV/div
CH2: I_{OUT1} , 150mA/div

$f_{OSC} = 300kHz$, $V_{OUT1} = 3.3V$
 $V_{IN} = 5.0V$, $I_{OUT1} = 300mA \rightarrow 100\mu A$

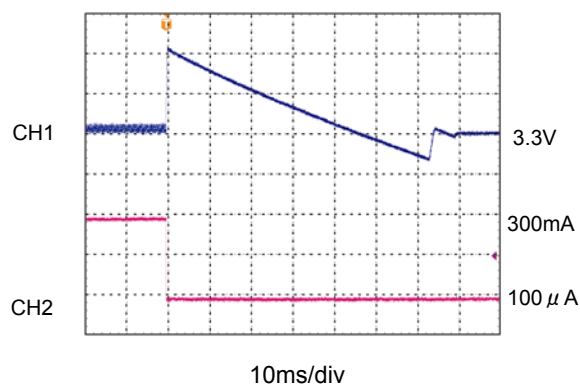

CH1: V_{OUT1} , AC-COUPLED, 50mV/div
CH2: I_{OUT1} , 150mA/div

● PWM/PFM Switching Control

$f_{OSC} = 300kHz$, $V_{OUT1} = 3.3V$
 $V_{IN} = 5.0V$, $I_{OUT1} = 100\mu A \rightarrow 300mA$

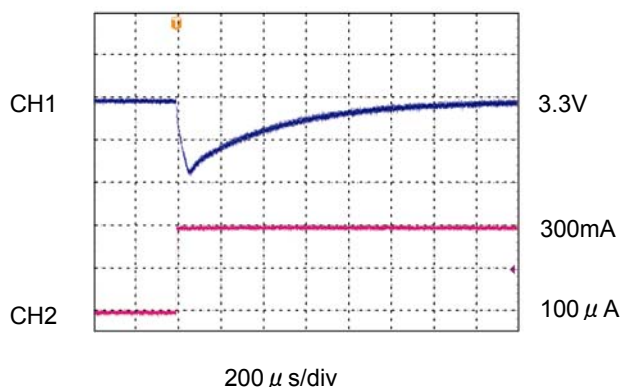

CH1: V_{OUT1} , AC-COUPLED, 100mV/div
CH2: I_{OUT1} , 150mA/div

$f_{OSC} = 300kHz$, $V_{OUT1} = 3.3V$
 $V_{IN} = 5.0V$, $I_{OUT1} = 300mA \rightarrow 100\mu A$

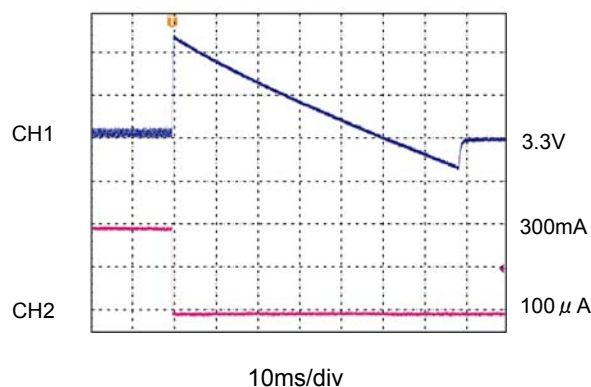

CH1: V_{OUT1} , AC-COUPLED, 100mV/div
CH2: I_{OUT1} , 150mA/div

TYPICAL PERFORMANCE CHARACTERISTICS (Continued)

< 1 ch. Step-Up DC/DC Controller > (Continued)

(25) Load Transient Response (Continued)

< $V_{OUT1} = 3.3V$, $V_{IN} = 5.0V$, $I_{OUT1} = 10mA \leftrightarrow 300mA$ >

PWM Control

$f_{osc} = 300kHz$, $V_{OUT1} = 3.3V$
 $V_{IN} = 5.0V$, $I_{OUT1} = 10mA \rightarrow 300mA$

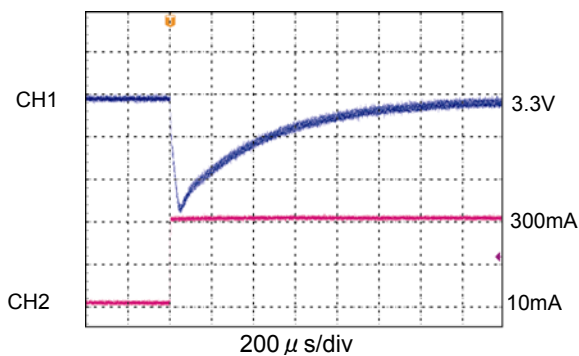

CH1: V_{OUT1} , AC-COUPLED, 50mV/div
 CH2: I_{OUT1} , 150mA/div

$f_{osc} = 300kHz$, $V_{OUT1} = 3.3V$
 $V_{IN} = 5.0V$, $I_{OUT1} = 300mA \rightarrow 10mA$

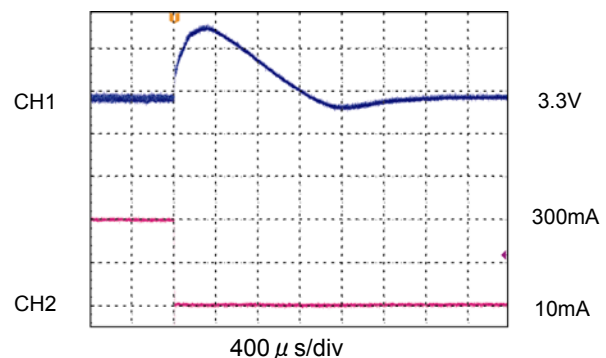

CH1: V_{OUT1} , AC-COUPLED, 50mV/div
 CH2: I_{OUT1} , 150mA/div

PWM/PFM Switching Control

$f_{osc} = 300kHz$, $V_{OUT1} = 3.3V$
 $V_{IN} = 5.0V$, $I_{OUT1} = 10mA \rightarrow 300mA$

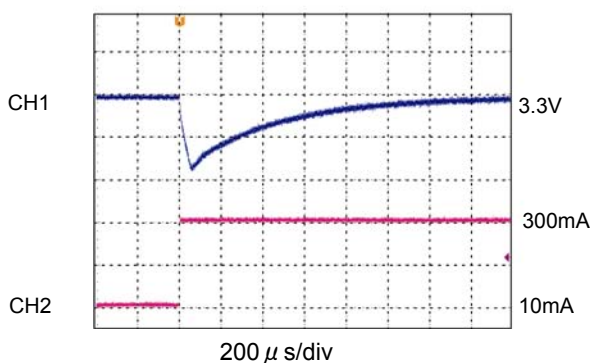

CH1: V_{OUT1} , AC-COUPLED, 100mV/div
 CH2: I_{OUT1} , 150mA/div

$f_{osc} = 300kHz$, $V_{OUT1} = 3.3V$
 $V_{IN} = 5.0V$, $I_{OUT1} = 300mA \rightarrow 10mA$

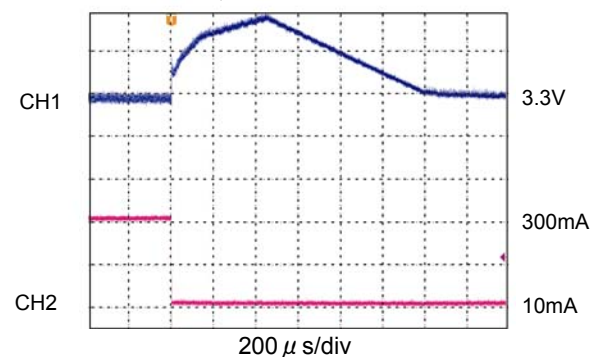

CH1: V_{OUT1} , AC-COUPLED, 50mV/div
 CH2: I_{OUT1} , 150mA/div

■ TYPICAL PERFORMANCE CHARACTERISTICS (Continued)

< 1 ch. Step-Up DC/DC Controller > (Continued)

(25) Load Transient Response (Continued)

< $V_{OUT1} = 0.9V$, $V_{IN} = 3.3V$, $I_{OUT1} = 100\mu A \leftrightarrow 300mA$ >

● PWM Control

$f_{osc}=300kHz$, $V_{OUT1} = 0.9V$
 $V_{IN}=3.3V$, $I_{OUT1} = 100\mu A \rightarrow 300mA$

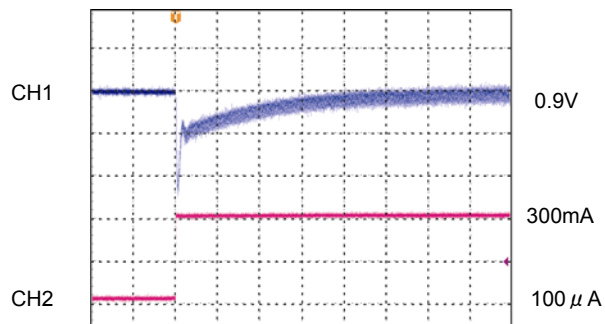

200 μ s/div
CH1: V_{OUT1} , AC-COUPLED, 20mV/div
CH2: I_{OUT1} , 150mA/div

$f_{osc}=300kHz$, $V_{OUT1} = 0.9V$
 $V_{IN}=3.3V$, $I_{OUT1} = 300mA \rightarrow 100\mu A$

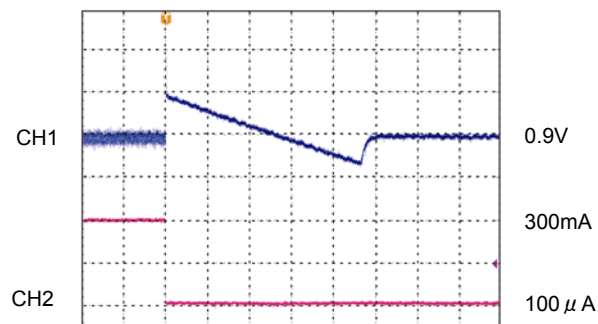

4ms/div
CH1: V_{OUT1} , AC-COUPLED, 20mV/div
CH2: I_{OUT1} , 150mA/div

● PWM/PFM Switching Control

$f_{osc}=300kHz$, $V_{OUT1} = 0.9V$
 $V_{IN}=3.3V$, $I_{OUT1} = 100\mu A \rightarrow 300mA$

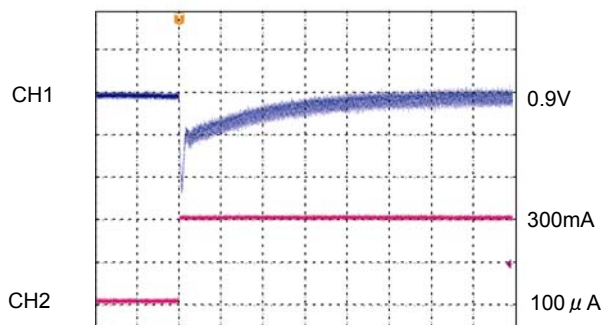

200 μ s/div
CH1: V_{OUT1} , AC-COUPLED, 20mV/div
CH2: I_{OUT1} , 150mA/div

$f_{osc}=300kHz$, $V_{OUT1} = 0.9V$
 $V_{IN}=3.3V$, $I_{OUT1} = 300mA \rightarrow 100\mu A$

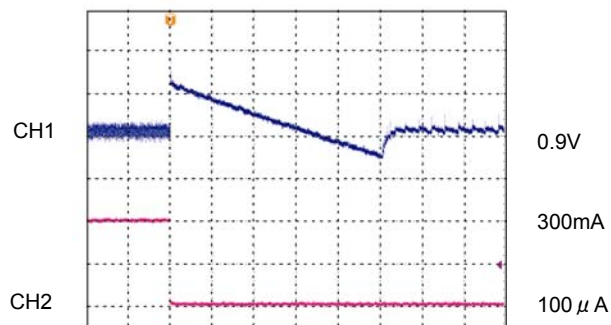

4ms/div
CH1: V_{OUT1} , AC-COUPLED, 20mV/div
CH2: I_{OUT1} , 150mA/div

TYPICAL PERFORMANCE CHARACTERISTICS (Continued)

< 1 ch. Step-Up DC/DC Controller > (Continued)

(25) Load Transient Response (Continued)

< $V_{OUT1} = 0.9V$, $V_{IN} = 3.3V$, $I_{OUT1} = 10mA \leftrightarrow 300mA$ >

● PWM Control

$f_{OSC} = 300kHz$, $V_{OUT1} = 0.9V$
 $V_{IN} = 3.3V$, $I_{OUT1} = 10mA \rightarrow 300mA$

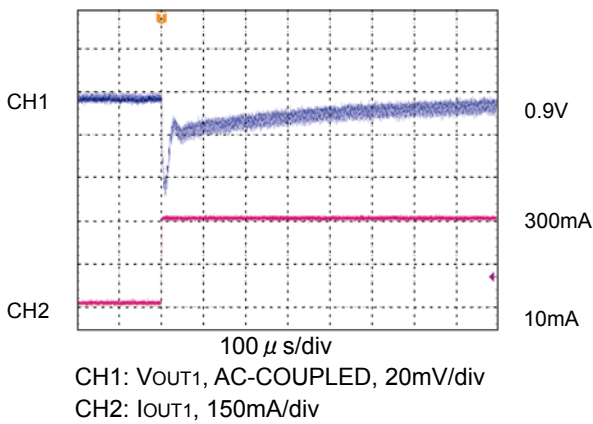

$f_{OSC} = 300kHz$, $V_{OUT1} = 0.9V$
 $V_{IN} = 3.3V$, $I_{OUT1} = 300mA \rightarrow 10mA$

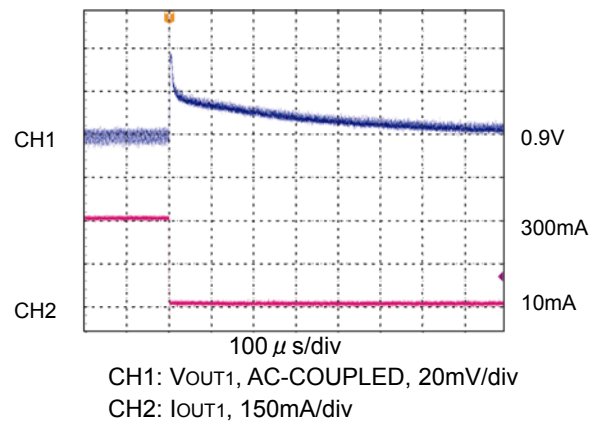

● PWM/PFM Switching Control

$f_{OSC} = 300kHz$, $V_{OUT1} = 0.9V$
 $V_{IN} = 3.3V$, $I_{OUT1} = 10mA \rightarrow 300mA$

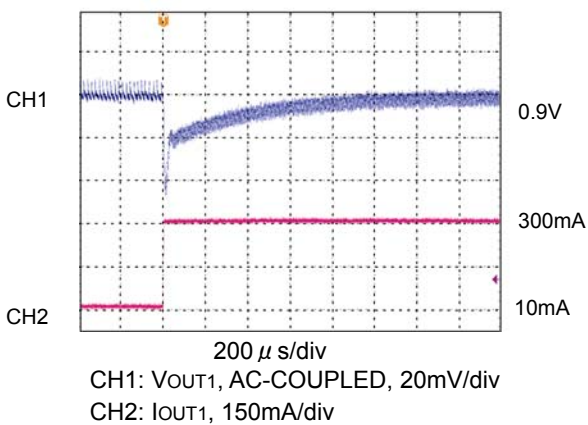

$f_{OSC} = 300kHz$, $V_{OUT1} = 0.9V$
 $V_{IN} = 3.3V$, $I_{OUT1} = 300mA \rightarrow 10mA$

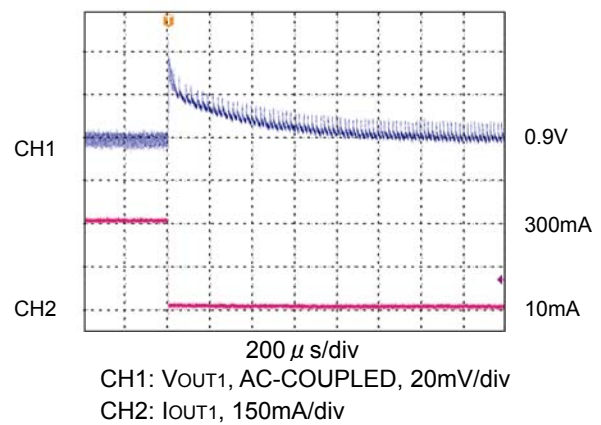

■ TYPICAL PERFORMANCE CHARACTERISTICS (Continued)

< 1 ch. Step-Up DC/DC Controller > (Continued)

(25) Load Transient Response (Continued)

< PWM Control ⇔ PWM / PFM Switching Control >

$f_{osc}=300kHz$, $V_{OUT1}=3.3V$
 $V_{IN}=5.0V$, $I_{OUT1}=5mA$, PWM1 'L'→'H'

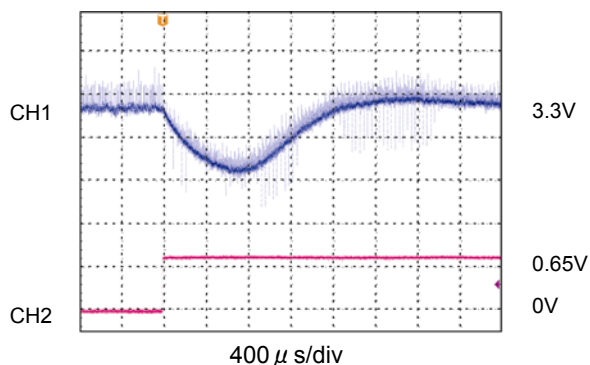

CH1: V_{OUT1} , AC-COUPLED, 10mV/div
CH2: PWM1, 0.5V/div

$f_{osc}=300kHz$, $V_{OUT1}=3.3V$
 $V_{IN}=5.0V$, $I_{OUT1}=5A$, PWM1 'H'→'L'

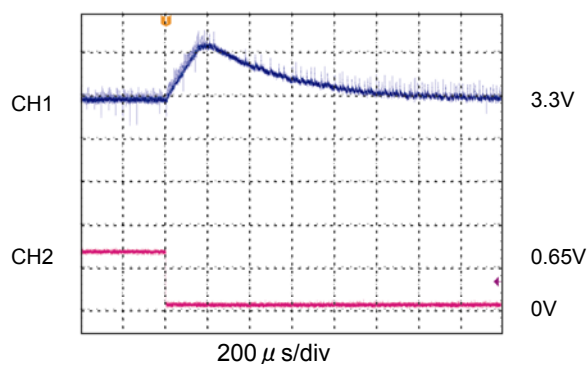

CH1: V_{OUT1} , AC-COUPLED, 20mV/div
CH2: PWM1, 0.5V/div

< Soft-Start Wave Form >

$f_{osc}=300kHz$, $V_{OUT1}=3.3V$
 $V_{IN}=5.0V$, $I_{OUT1}=300mA$
N1 'L'→'H', $C_{IN}=47\mu F$

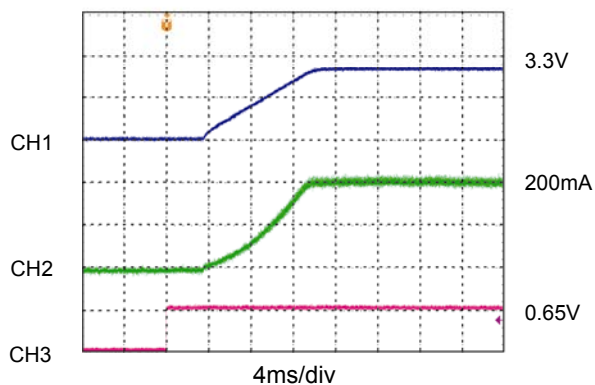

CH1: V_{OUT1} , 2.0V/div
CH2: I_{IN1} , 100mA/div
CH3: EN1, 0.5V/div

$f_{osc}=300kHz$, $V_{OUT1}=3.3V$
 $V_{IN}=5.0V$, $I_{OUT1}=100mA$
EN1 'L'→'H', $C_{IN}=47\mu F$

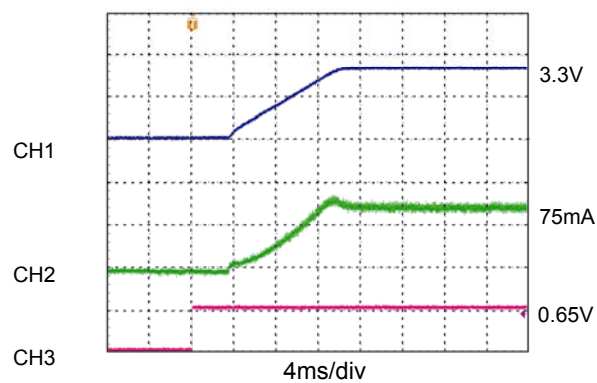

CH1: V_{OUT1} , 2.0V/div
CH2: I_{IN1} , 50mA/div
CH3: EN1, 0.5V/div

* EN2=GND

TYPICAL PERFORMANCE CHARACTERISTICS (Continued)

< 2 ch. Inverting DC/DC Controller >

(25) Load Transient Response (Continued)

< $V_{OUT2} = -7.5V$, $V_{IN} = 3.3V$, $I_{OUT2} = -100\mu A \leftrightarrow -50mA$ >

(Tantalum capacitor use)

● PWM Control

$f_{OSC} = 180kHz$, $V_{OUT2} = -7.5V$
 $V_{IN} = 3.3V$, $I_{OUT2} = 100\mu A \rightarrow -50mA$

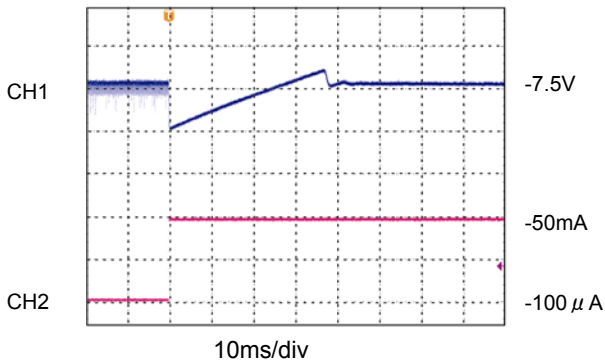

CH1: V_{OUT2} , AC-COUPLED, 50mV/div
 CH2: I_{OUT2} , 50mA/div

$f_{OSC} = 180kHz$, $V_{OUT2} = -7.5V$
 $V_{IN} = 3.3V$, $I_{OUT2} = -50mA \rightarrow -100\mu A$

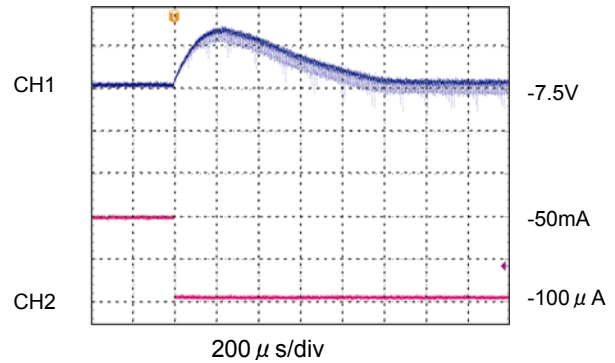

CH1: V_{OUT2} , AC-COUPLED, 50mV/div
 CH2: I_{OUT2} , 50mA/div

● PWM/PFM Switching Control

$f_{OSC} = 180kHz$, $V_{OUT2} = -7.5V$
 $V_{IN} = 3.3V$, $I_{OUT2} = -100\mu A \rightarrow -50mA$

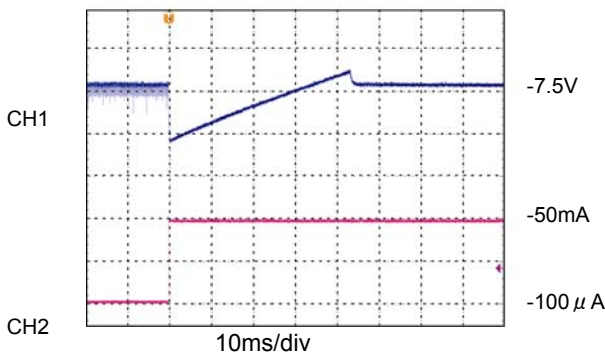

CH1: V_{OUT2} , AC-COUPLED, 50mV/div
 CH2: I_{OUT2} , 50mA/div

$f_{OSC} = 180kHz$, $V_{OUT2} = -7.5V$
 $V_{IN} = 3.3V$, $I_{OUT2} = -50mA \rightarrow -100\mu A$

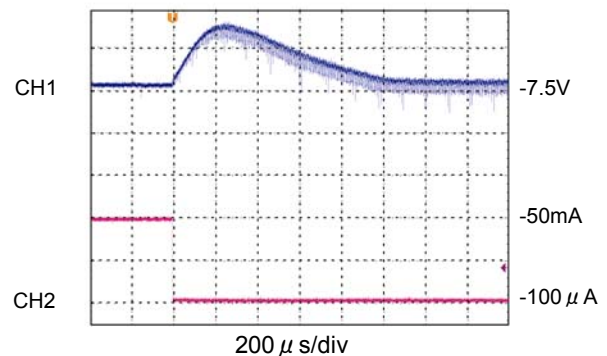

CH1: V_{OUT2} , AC-COUPLED, 50mV/div
 CH2: I_{OUT2} , 50mA/div

■ TYPICAL PERFORMANCE CHARACTERISTICS (Continued)

< 2 ch. Inverting DC/DC Controller > (Continued)
(25) Load Transient Response (Continued)

< $V_{OUT2} = -7.5V$, $V_{IN} = 3.3V$, $I_{OUT2} = -100\mu A \leftrightarrow -20mA$ > (Ceramic capacitor use when coil current is discontinued.)

● PWM Control

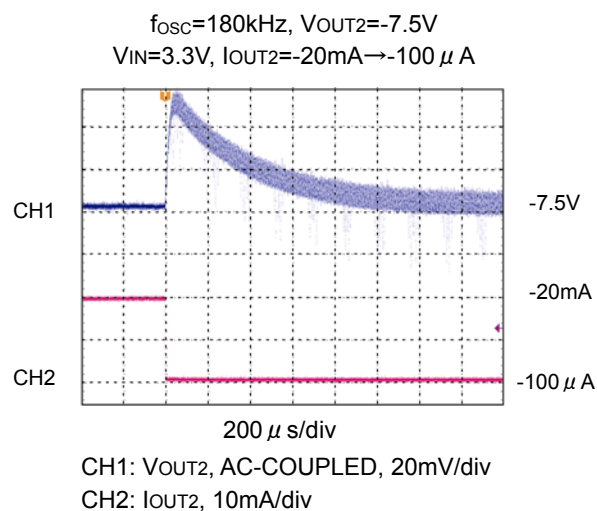
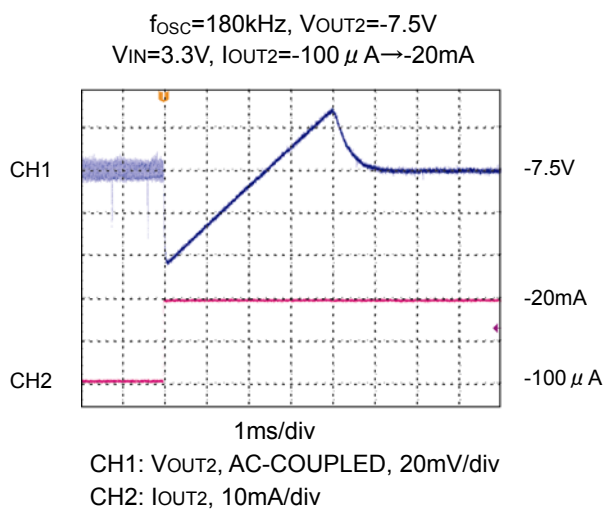

● PWM/PFM Switching Control

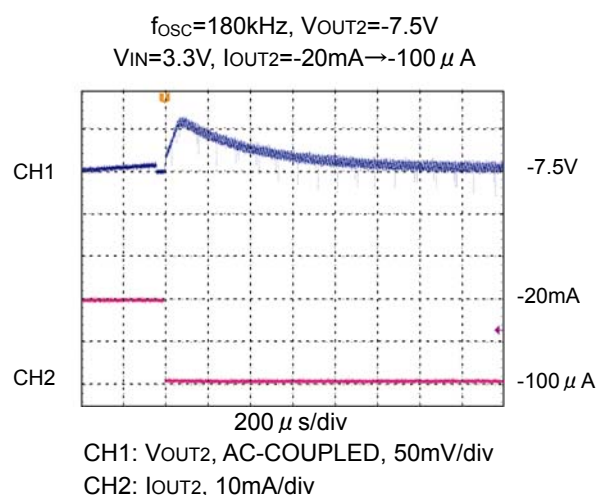
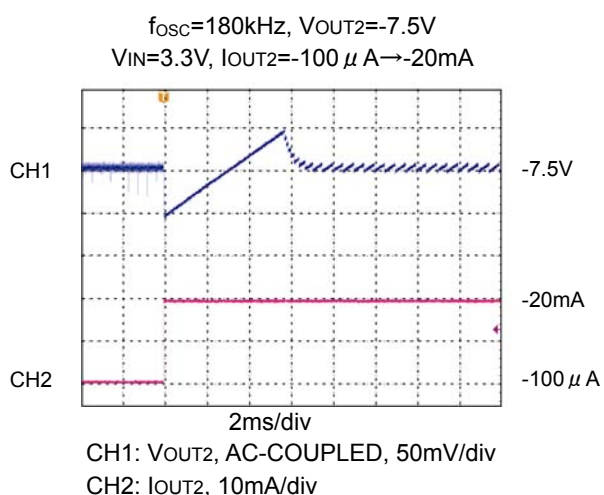

TYPICAL PERFORMANCE CHARACTERISTICS (Continued)

< 2 ch. Inverting DC/DC Controller > (Continued)

(25) Load Transient Response (Continued)

< $V_{OUT2} = -7.5V$, $V_{IN} = 3.3V$, $I_{OUT2} = -1mA \leftrightarrow -20mA$ >

● PWM Control

$f_{OSC}=180kHz$, $V_{OUT2}=-7.5V$
 $V_{IN}=3.3V$, $I_{OUT2}=-1mA \rightarrow -20mA$

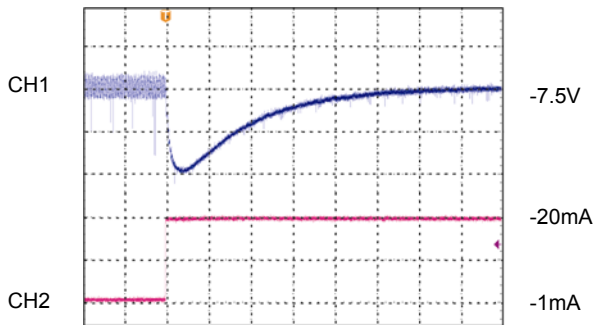

200 μ s/div
 CH1: V_{OUT2} , AC-COUPLED, 20mV/div
 CH2: I_{OUT2} , 10mA/div

$f_{OSC}=180kHz$, $V_{OUT2}=-7.5V$
 $V_{IN}=3.3V$, $I_{OUT2}=-20mA \rightarrow -1mA$

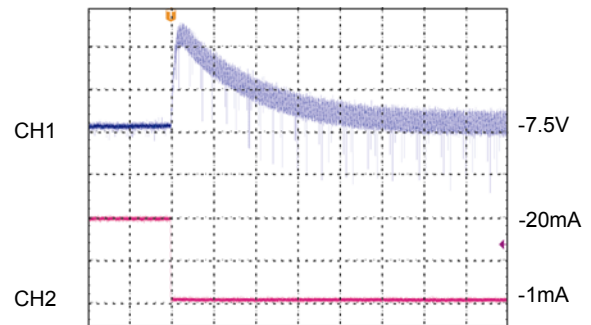

200 μ s/div
 CH1: V_{OUT2} , AC-COUPLED, 20mV/div
 CH2: I_{OUT2} , 10mA/div

● PWM/PFM Switching Control

$f_{OSC}=180kHz$, $V_{OUT2}=-7.5V$
 $V_{IN}=3.3V$, $I_{OUT2}=-1mA \rightarrow -20mA$

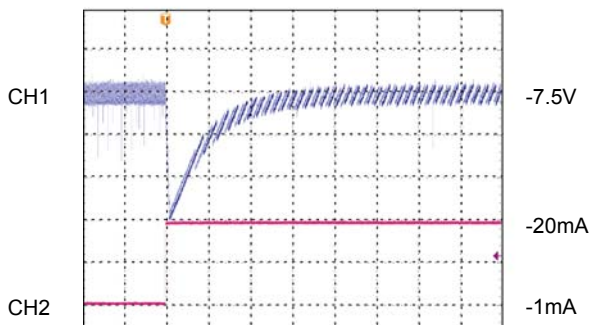

400 μ s/div
 CH1: V_{OUT2} , AC-COUPLED, 20mV/div
 CH2: I_{OUT2} , 10mA/div

$f_{OSC}=180kHz$, $V_{OUT2}=-7.5V$
 $V_{IN}=3.3V$, $I_{OUT2}=-20mA \rightarrow -1mA$

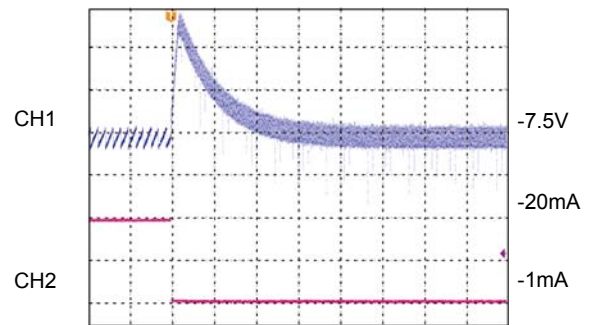

400 μ s/div
 CH1: V_{OUT2} , AC-COUPLED, 20mV/div
 CH2: I_{OUT2} , 10mA/div

■ TYPICAL PERFORMANCE CHARACTERISTICS (Continued)

< 2 ch. Inverting DC/DC Controller > (Continued)

(25) Load Transient Response (Continued)

< PWM Control ↔ PWM / PFM Switching Control >

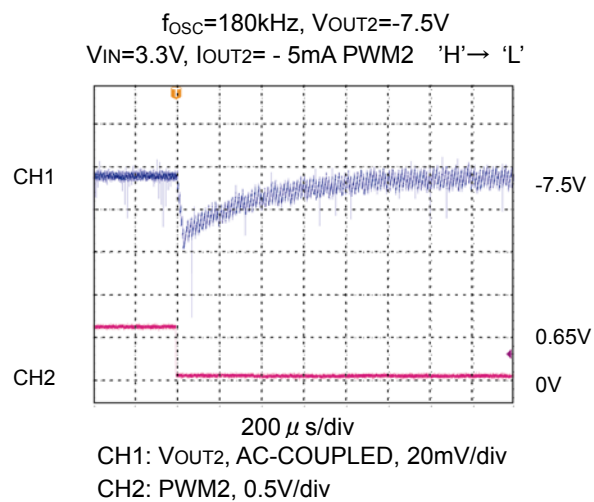
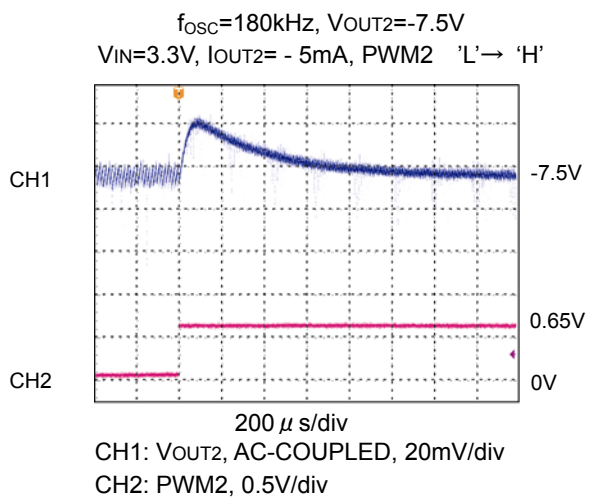

PACKAGING INFORMATION

● MSOP-10

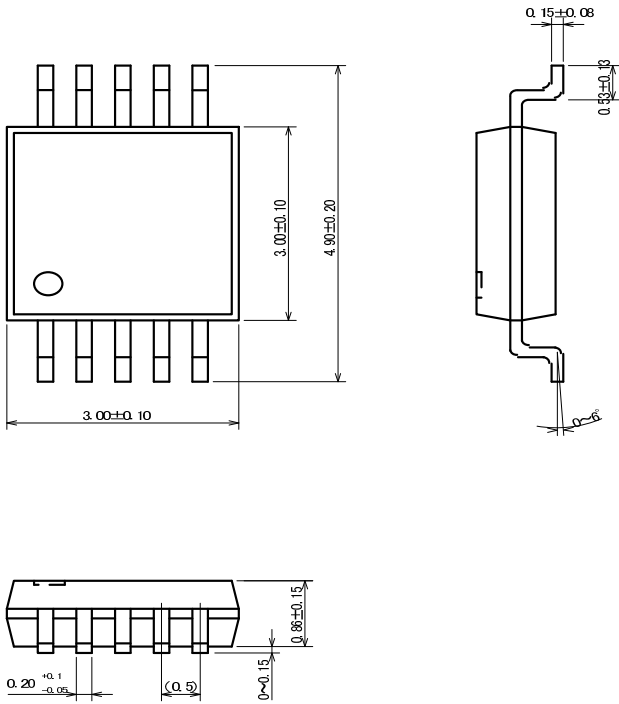

● USP-10

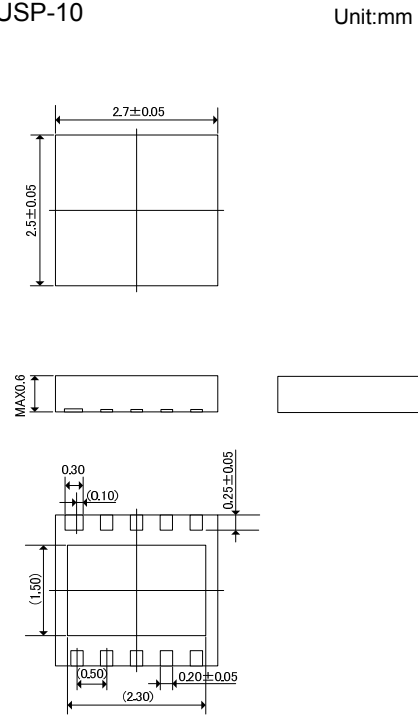

● USP-10 Reference Pattern Layout

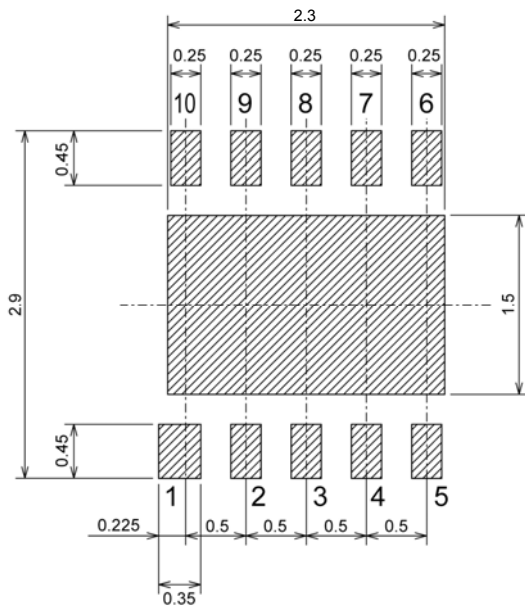

● USP-10 Reference Metal Mask Design

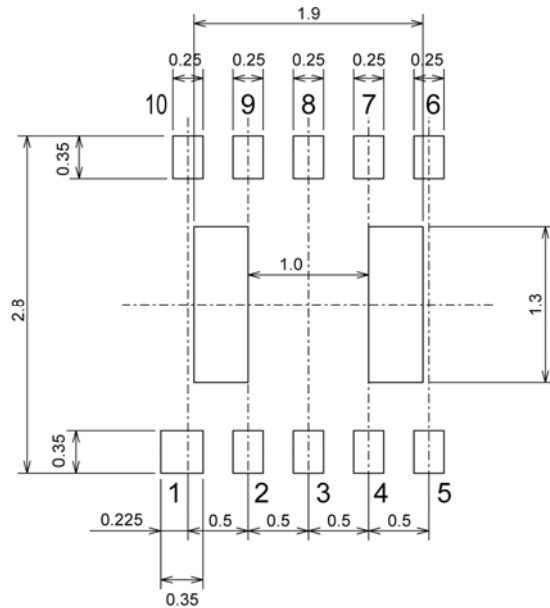

MARKING RULE

● MSOP-10, USP-10

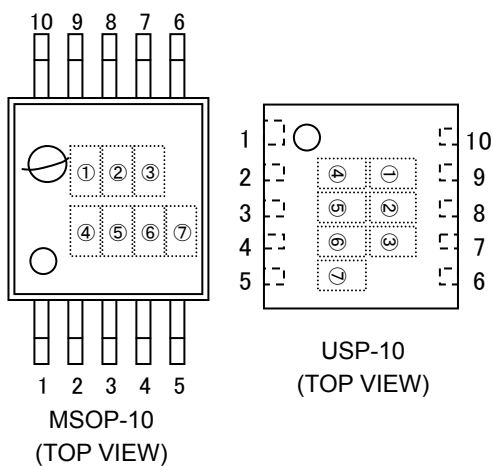

① represents product series

MARK	PRODUCT SERIES
5	XC9505B09xxx

② represents type of DC/DC controller

MARK	TYPE	PRODUCT SERIES
B	Standard	XC9505B09xxx

③,④ represents FB voltage

MARK		VOLTAGE (V)	PRODUCT SERIES
③	④		
0	9	0.9	XC9505B09xxx

⑤ represents oscillation frequency

MARK	OSCILLATION FREQUENCY (kHz)	PRODUCT SERIES
2	180	XC9505B092xx
3	300	XC9505B093xx
5	500	XC9505B095xx

⑥,⑦ represents production lot number

00, 01, to 09, 0A to 0Z, 19, 1A, repeated (G, I, J, O, Q, W excluded)

Note: No character inversion used.

MARK		PRODUCT ROT
⑥	⑦	
0	3	03
1	A	1A

1. The products and product specifications contained herein are subject to change without notice to improve performance characteristics. Consult us, or our representatives before use, to confirm that the information in this datasheet is up to date.
2. We assume no responsibility for any infringement of patents, patent rights, or other rights arising from the use of any information and circuitry in this datasheet.
3. Please ensure suitable shipping controls (including fail-safe designs and aging protection) are in force for equipment employing products listed in this datasheet.
4. The products in this datasheet are not developed, designed, or approved for use with such equipment whose failure or malfunction can be reasonably expected to directly endanger the life of, or cause significant injury to, the user.
(e.g. Atomic energy; aerospace; transport; combustion and associated safety equipment thereof.)
5. Please use the products listed in this datasheet within the specified ranges.
Should you wish to use the products under conditions exceeding the specifications, please consult us or our representatives.
6. We assume no responsibility for damage or loss due to abnormal use.
7. All rights reserved. No part of this datasheet may be copied or reproduced without the prior permission of TOREX SEMICONDUCTOR LTD.

TOREX SEMICONDUCTOR LTD.

单击下面可查看定价，库存，交付和生命周期等信息

[>>Torex Semiconductor\(特瑞仕\)](#)