

XC9281/XC9282 Series

ETR05063-003

HiSAT-COT[®] Control Extremely Small 600mA Step-Down DC/DC Converters

■ GENERAL DESCRIPTION

☆ Green Operation Compatible

The XC9281/XC9282 series are 600mA synchronous rectification DC/DC converters adopting HiSAT-COT^(*) control. Due to increasing the oscillation frequency to high frequency, coil with a size of 1.0 x 0.5 mm can be used. A 0.6 x 0.3 mm ceramic capacitor can be used for the input capacitance (C_{IN}) and the output capacitance (C_L), realizing that the mounting area including peripheral components can be reduced to 3.52 mm².

Due to increasing the oscillation frequency to a high frequency, the mounting area is reduced. Additionally, an efficiency equal to or higher than that of conventional products can realize by improving on-resistance and current consumption. Because of these features, XC9281/XC9282 series are ideal for equipment requiring miniaturization and low profile mounting area, and battery-powered equipment such as mobile equipment.

Moreover, the high-speed transient response technology of the HiSAT-COT control makes it possible to minimize the fluctuation of the output voltage for a load transient condition. This feature is optimal for applications requiring a fast response and output voltage stability for an instantaneous load fluctuation like FPGA.

(*)HiSAT-COT is a proprietary high-speed transient response technology for DC/DC converter which was developed by Torex. It is Ideal for the LSI's that require high precision and high stability power supply voltage.

■ APPLICATIONS

- Smart phones / Mobile phones
- Wireless earphone / Headset
- Wearable devices
- DSC / Camcorder
- Portable game consoles
- Smartcard
- Power supply for module
- Various small power sources

■ FEATURES

Input Voltage Range	:	2.5V ~ 5.5V
Output Voltage Range	:	0.7V ~ 1.15V(±2.0%) 1.2V ~ 3.6V(±1.5%)
Output Current	:	600mA
Quiescent Current	:	11μA(XC9282 PWM/PFM Auto)
Oscillation Frequency	:	4MHz, 6MHz
Efficiency (f _{osc} =4MHz)	:	90.0%(V _{IN} =3.7V, V _{OUT} =1.8V, I _{OUT} =200mA)
Control Methods	:	HiSAT-COT Control PWM Control (XC9281) PWM/PFM Auto (XC9282)
Protection Functions	:	Current Limit
Functions	:	Soft-Start, UVLO C _L Discharge (Type B)
Input / Output Capacitor	:	Ceramic Capacitor
Operating Ambient Temperature	:	-40°C ~ +105°C
Package	:	LGA-6B01(1.2 x 1.2 x 0.3mm) WLP-5-06(0.88 x 0.96 x 0.33mm)
Environmentally	:	EU RoHS Compliant, Pb Free

■ PCB IMAGE

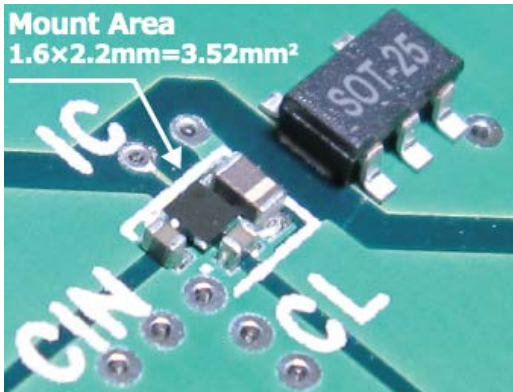

■ TYPICAL APPLICATION CIRCUIT

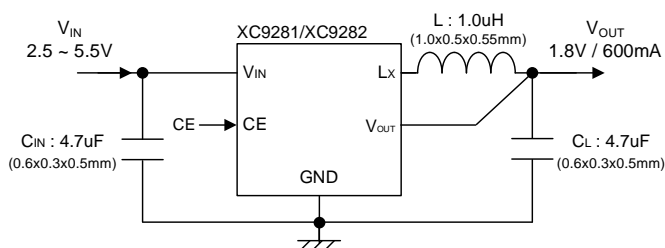

■ TYPICAL PERFORMANCE CHARACTERISTICS

XC9281B18D / XC9282B18D (V_{OUT}=1.8V)

L = 1.0μH (DFE18SAN1R0MG0L)

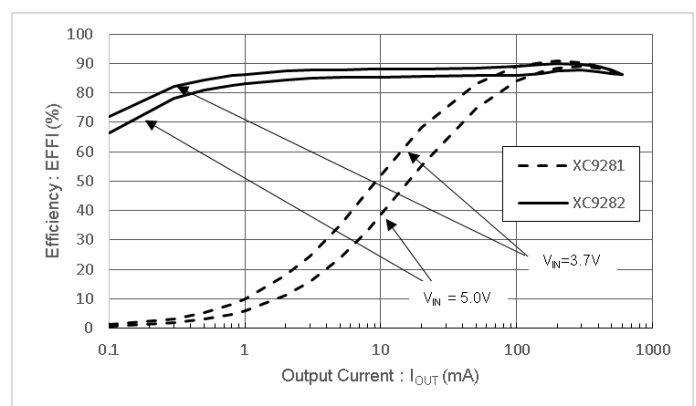
C_{IN} = 4.7μF (GRM035R60J475ME15) C_L = 4.7μF (GRM035R60J475ME15)

■ BLOCK DIAGRAM

1) XC9281/XC9282 Series Type A

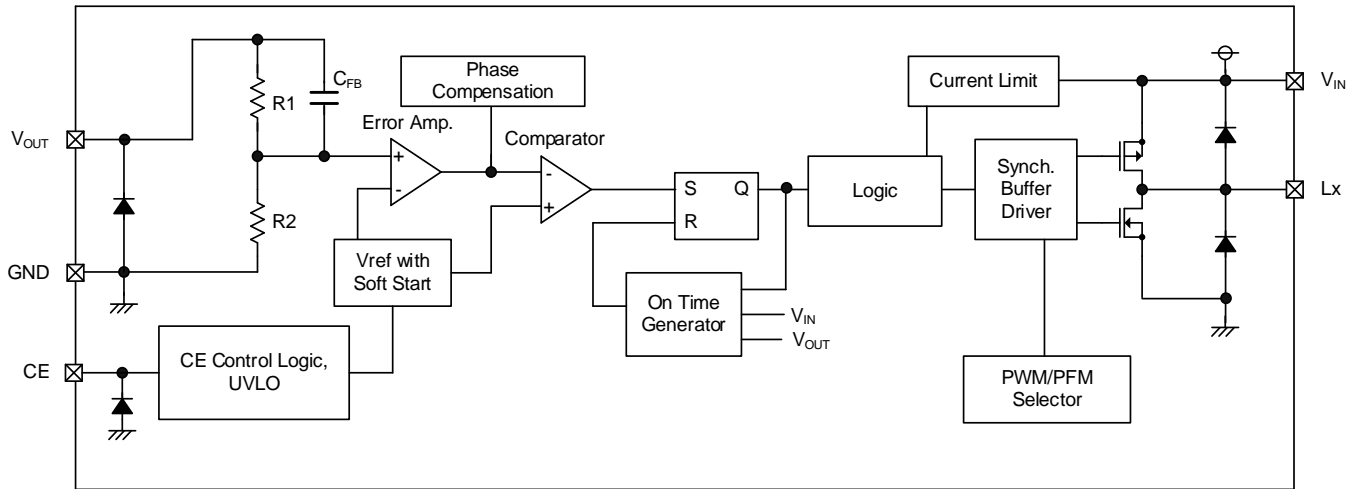

(*) "PWM/PFM Selector" in the XC9281 series is fixed to PWM control.

"PWM/PFM Selector" In the XC9282 series is fixed to PWM/PFM automatic switching control.

Diodes inside the circuit are an ESD protection diode and a parasitic diode.

2) XC9281/XC9282 Series Type B

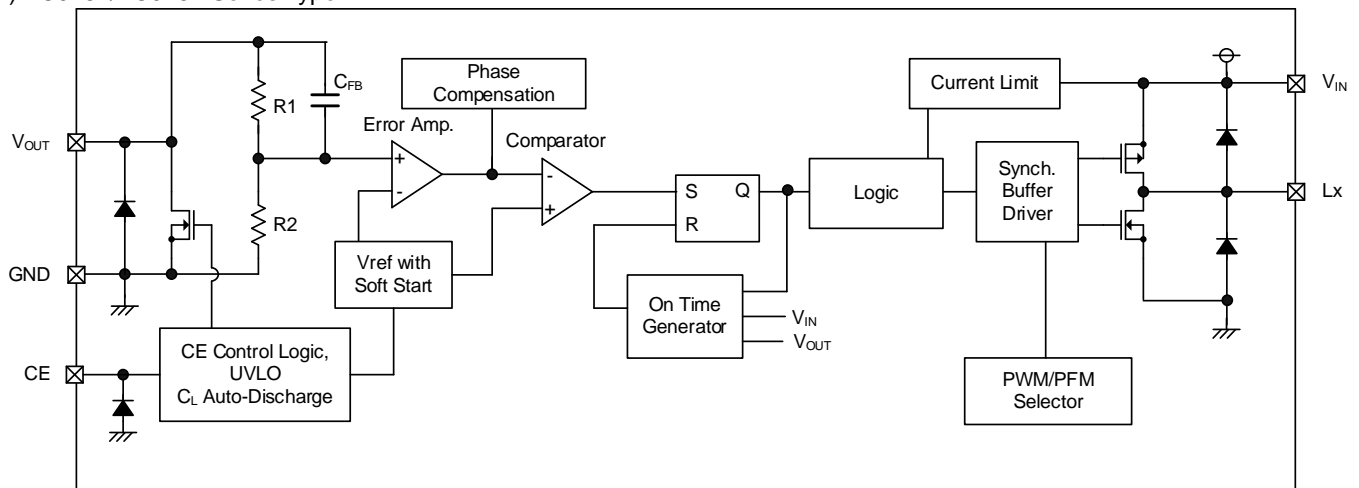

(*) "PWM/PFM Selector" in the XC9281 series is fixed to PWM control.

"PWM/PFM Selector" In the XC9282 series is fixed to PWM/PFM automatic switching control.

Diodes inside the circuit are an ESD protection diode and a parasitic diode.

■ PRODUCT CLASSIFICATION

1) Ordering Information

XC9281①②③④⑤⑥-⑦ PWM Control

XC9282①②③④⑤⑥-⑦ PWM/PFM Automatic switching control

DESIGNATOR	ITEM	SYMBOL	DESCRIPTION
①	Type	A	Refer to Selection Guide
		B	
②③	Output Voltage	07~36	Output voltage options e.g. 1.2V → ②=1, ③=2 1.25V → ②=1, ③=C 0.05V increments : 0.05=A, 0.15=B, 0.25=C, 0.35=D, 0.45=E, 0.55=F, 0.65=H, 0.75=K, 0.85=L, 0.95=M
④	Oscillation Frequency	D	4.0MHz
		E	6.0MHz
⑤⑥-⑦ ^(*)	Packages (Order Unit)	1R-G	LGA-6B01 (5,000pcs/Reel)
		0R-G	WLP-5-06 (5,000pcs/Reel)

(*) The "-G" suffix denotes Halogen and Antimony free as well as being fully EU RoHS compliant.

2) Selection Guide

TYPE	OUTPUT VOLTAGE	CHIP ENABLE	C _L AUTO-DISCHARGE	UVLO
A	Fixed	Yes	No	Yes
B	Fixed	Yes	Yes	Yes

TYPE	SOFT-START TIME	CURRENT LIMIT	AUTOMATIC RECOVERY (CURRENT LIMIT)
A	Fixed	Yes	Yes
B	Fixed	Yes	Yes

■ PIN CONFIGURATION

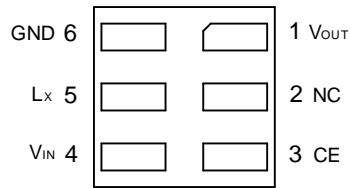

LGA-6B01
(BOTTOM VIEW)

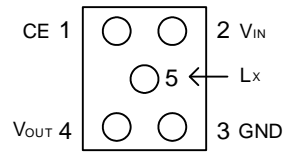

WLP-5-06
(BOTTOM VIEW)

■ PIN ASSIGNMENT

PIN NUMBER		PIN NAME	FUNCTIONS
LGA-6B01	WLP-5-06		
1	4	V _{OUT}	Output Voltage Monitor
2	-	NC	No Connection
3	1	CE	Chip Enable
4	2	V _{IN}	Power Input
5	5	Lx	Switching Output
6	3	GND	Ground

■ FUNCTION

PIN NAME	SIGNAL	STATUS
CE	L	Stand-by
	H	Active

Please do not leave the CE pin open.

■ ABSOLUTE MAXIMUM RATINGS

Ta=25°C

PARAMETER		SYMBOL	RATINGS	UNITS
V _{IN} Pin Voltage		V _{IN}	-0.3 ~ +6.2	V
Lx Pin Voltage		V _{Lx}	-0.3 ~ V _{IN} +0.3 or +6.2 ⁽¹⁾	V
V _{OUT} Pin Voltage		V _{OUT}	-0.3 ~ V _{IN} +0.3 or +4.0 ⁽²⁾	V
CE Pin Voltage		V _{CE}	-0.3 ~ +6.2	V
Power Dissipation	LGA-6B01	Pd	760 (JESD51-7 board) ⁽³⁾	mW
	WLP-5-06		500 (JESD51-7 board) ⁽³⁾	
Operating Ambient Temperature		Topr	-40 ~ +105	°C
Storage Temperature		Tstg	-55 ~ +125	°C

* All voltages are described based on the GND pin.

⁽¹⁾ The maximum value should be either V_{IN}+0.3V or +6.2V in the lowest.

⁽²⁾ The maximum value should be either V_{IN}+0.3V or +4.0V in the lowest.

⁽³⁾ The power dissipation figure shown is PCB mounted and is for reference only.
The mounting condition is please refer to PACKAGING INFORMATION.

ELECTRICAL CHARACTERISTICS

XC9281 / XC9282 Series

Ta=25°C

PARAMETER	SYMBOL	CONDITIONS	MIN.	TYP.	MAX.	UNITS	CIRCUIT
Output Voltage	V _{OUT}	V _{IN} = <C -1>, V _{OUT} = V _{OUT(T)} × 1.2 → V _{OUT(T)} × 0.8 V _{OUT} Voltage when Lx pin voltage changes from "L" level to "H" level ⁽¹⁾⁽⁷⁾	<E-1>	<E-2>	<E-3>	V	①
Operating Voltage Range	V _{IN}		2.5	-	5.5	V	②
Maximum Output Current	I _{OUTMAX}	When connected to external components ⁽²⁾ , V _{IN} = <C -1>	600	-	-	mA	②
UVLO Voltage ⁽³⁾	V _{UVLO}	V _{OUT} = 0V, V _{IN} = V _{CE} V _{IN} Voltage which Lx pin holding "L" level ⁽⁷⁾	1.66	2.00	2.40	V	①
Quiescent Current (XC9281)	I _q	V _{OUT} = 4.0V	-	590	948	μA	③
Quiescent Current (XC9282)	I _q	V _{OUT} = 4.0V	-	11.0	17.6	μA	③
Stand-by Current	I _{STB}	V _{IN} = 5.5V, V _{CE} = 0V, V _{OUT} = 0V, V _{Lx} = 0V	-	0.0	0.6	μA	④
ON time	t _{ON}	When connected to external components, V _{IN} =<C-1>, I _{OUT} =1mA	<E-5>	<E-6>	<E-7>	ns	②
Lx SW"H"ON Resistance ⁽⁴⁾	R _{LXH}	V _{IN} = 3.6V, V _{OUT} = 0V, I _{Lx} = 100mA ⁽⁵⁾	-	0.32	0.50	Ω	⑤
Lx SW"L"ON Resistance ⁽⁴⁾	R _{LXL}	V _{IN} = 3.6V, V _{OUT} = 3.9V, I _{Lx} = 100mA ⁽⁵⁾	-	0.26	0.35	Ω	⑤
Lx SW"H" Leakage Current	I _{LeakH}	V _{IN} =5.5V, V _{CE} =0V, V _{OUT} =0V, V _{Lx} =5.5V	-	0.0	10.0	μA	④
Lx SW"L" Leakage Current	I _{LeakL}	V _{IN} =5.5V, V _{CE} =0V, V _{OUT} =0V, V _{Lx} =0V	-	0.0	0.3	μA	④
Current Limit ⁽⁶⁾	I _{LIMH}	V _{IN} = 3.6V, V _{OUT} =0V I _{Lx} until Lx pin oscillates	750	1000	1500	mA	⑥
Output Voltage Temperature Characteristics	ΔV _{OUT} / (V _{OUT} × ΔTopr)	V _{IN} = <C -1>, V _{OUT} = V _{OUT(T)} × 1.2 → V _{OUT(T)} × 0.8 V _{OUT} Voltage when Lx pin voltage changes from "L" level to "H" level ⁽¹⁾⁽⁷⁾ , -40°C ≤ Topr ≤ 105°C	-	±100	-	ppm/°C	①
CE "H" Voltage	V _{CEH}	V _{IN} = 5.5V, V _{OUT} = 0V, V _{CE} Voltage which Lx pin holding "H" level ⁽⁷⁾	1.20	-	5.50	V	①
CE "L" Voltage	V _{CEL}	V _{IN} = 5.5V, V _{OUT} = 0V, V _{CE} Voltage which Lx pin holding "L" level ⁽⁷⁾	GND	-	0.30	V	①
CE "H" Current	I _{CEH}	V _{CE} = 5.5V, V _{OUT} = 4.0V	-0.1	0.0	0.1	μA	③
CE "L" Current	I _{CEL}	V _{IN} = 5.5V, V _{CE} = 0V, V _{OUT} = 0V	-0.1	0.0	0.1	μA	④
Soft-Start Time	t _{SS}	V _{IN} = 3.6V, V _{CE} = 0V → 3.6V, V _{OUT} = V _{OUT(T)} × 0.9 After "H" is fed to CE, the time by when clocks are generated at Lx pin.	54	110	201	μs	①
C _L Discharge Resistance (B Type)	R _{DCHG}	V _{CE} = 0V, V _{OUT} = 1.0V	100	145	200	Ω	⑦

Unless otherwise stated, V_{IN}=5V, V_{CE}=5V, V_{OUT(T)}=Nominal Value,

NOTE:

⁽¹⁾ For PWM control.

⁽²⁾ When the difference between the input and the output is small, 100% duty might come up and internal control circuits keep Pch driver turning on even though the output current is not so large.

If current is further pulled from this state, output voltage will decrease because of Pch driver ON resistance.

⁽³⁾ Including UVLO detect voltage, hysteresis operating voltage range for UVLO release voltage.

⁽⁴⁾ Design value for WLP-5-06

⁽⁵⁾ R_{LXH} = (V_{IN} - Lx pin measurement voltage) / 100mA, R_{LXL} = Lx pin measurement voltage / 100mA

⁽⁶⁾ Current limit denotes the level of detection at peak of coil current.

⁽⁷⁾ "H" = V_{IN} - 1.2V ~ V_{IN}, "L" = - 0.1V ~ + 0.1V

ELECTRICAL CHARACTERISTICS (Continued)

SPEC Table

NOMINAL OUTPUT VOLTAGE	INPUT VOLTAGE	V _{OUT}			t _{ON}					
					f _{osc} =4.0MHz			f _{osc} =6.0MHz		
		<C-1>	<E-1>	<E-2>	<E-3>	<E-5>	<E-6>	<E-7>	<E-5>	<E-6>
V _{OUT(T)}	V _{IN}	MIN.	TYP.	MAX.	MIN.	TYP.	MAX.	MIN.	TYP.	MAX.
0.70	2.70	0.686	0.700	0.714	32	65	98	6	43	62
0.75	2.75	0.735	0.750	0.765	34	68	102	7	45	63
0.80	2.80	0.784	0.800	0.816	35	71	107	7	48	67
0.85	2.85	0.833	0.850	0.867	37	75	113	7	50	71
0.90	2.90	0.882	0.900	0.918	39	78	117	8	52	72
0.95	2.95	0.931	0.950	0.969	40	81	122	8	54	76
1.00	3.00	0.980	1.000	1.020	49	83	117	8	56	78
1.05	3.05	1.029	1.050	1.071	51	86	121	9	57	81
1.10	3.10	1.078	1.100	1.122	53	89	125	9	59	83
1.15	3.15	1.127	1.150	1.173	54	91	128	9	61	85
1.20	3.20	1.182	1.200	1.218	56	94	132	37	63	89
1.25	3.25	1.232	1.250	1.268	57	96	135	38	64	90
1.30	3.30	1.281	1.300	1.319	58	98	138	39	66	93
1.35	3.35	1.330	1.350	1.370	60	101	142	40	67	94
1.40	3.40	1.379	1.400	1.421	61	103	145	41	69	97
1.45	3.45	1.429	1.450	1.471	63	105	147	42	70	98
1.50	3.50	1.478	1.500	1.522	64	107	150	42	71	100
1.55	3.55	1.527	1.550	1.573	65	109	153	43	73	103
1.60	3.60	1.576	1.600	1.624	66	111	156	44	74	104
1.65	3.65	1.626	1.650	1.674	67	113	159	45	75	105
1.70	3.70	1.675	1.700	1.725	69	115	161	46	77	108
1.75	3.75	1.724	1.750	1.776	70	117	164	46	78	110
1.80	3.80	1.773	1.800	1.827	82	118	154	47	79	111
1.85	3.85	1.823	1.850	1.877	84	120	156	48	80	112
1.90	3.90	1.872	1.900	1.928	85	122	159	48	81	114
1.95	3.95	1.921	1.950	1.979	86	123	160	49	82	115
2.00	4.00	1.970	2.000	2.030	87	125	163	49	83	117
2.05	4.05	2.020	2.050	2.080	88	127	166	50	84	118
2.10	4.10	2.069	2.100	2.131	89	128	167	51	85	119
2.15	4.15	2.118	2.150	2.182	91	130	169	51	86	121
2.20	4.20	2.167	2.200	2.233	91	131	171	52	87	122
2.25	4.25	2.217	2.250	2.283	92	132	172	52	88	124
2.30	4.30	2.266	2.300	2.334	93	134	175	53	89	125
2.35	4.35	2.315	2.350	2.385	94	135	176	54	90	126
2.40	4.40	2.364	2.400	2.436	95	136	177	54	91	128
2.45	4.45	2.414	2.450	2.486	96	138	180	55	92	129
2.50	4.50	2.463	2.500	2.537	97	139	181	55	93	131
2.55	4.55	2.512	2.550	2.588	98	140	182	55	93	131
2.60	4.60	2.561	2.600	2.639	98	141	184	56	94	132

ELECTRICAL CHARACTERISTICS (Continued)

SPEC Table

NOMINAL OUTPUT VOLTAGE	INPUT VOLTAGE	V _{OUT}			t _{ON}					
					f _{osc} =4.0MHz			f _{osc} =6.0MHz		
		<C-1>	<E-1>	<E-2>	<E-3>	<E-5>	<E-6>	<E-7>	<E-5>	<E-6>
V _{OUT(T)}	V _{IN}	MIN.	TYP.	MAX.	MIN.	TYP.	MAX.	MIN.	TYP.	MAX.
2.65	4.65	2.611	2.650	2.689	99	142	185	57	95	133
2.70	4.70	2.660	2.700	2.740	100	144	188	57	96	135
2.75	4.75	2.709	2.750	2.791	101	145	189	57	96	135
2.80	4.80	2.758	2.800	2.842	102	146	190	58	97	136
2.85	4.85	2.808	2.850	2.892	102	147	192	58	98	138
2.90	4.90	2.857	2.900	2.943	103	148	193	59	99	139
2.95	4.95	2.906	2.950	2.994	104	149	194	59	99	139
3.00	5.00	2.955	3.000	3.045	105	150	195	60	100	140
3.05	5.05	3.005	3.050	3.095	105	151	197	60	101	142
3.10	5.10	3.054	3.100	3.146	106	152	198	60	101	142
3.15	5.15	3.103	3.150	3.197	107	153	199	61	102	143
3.20	5.20	3.152	3.200	3.248	107	154	201	61	103	145
3.25	5.25	3.202	3.250	3.298	108	155	202	61	103	145
3.30	5.30	3.251	3.300	3.349	109	156	203	62	104	146
3.35	5.35	3.300	3.350	3.400	109	157	205	62	104	146
3.40	5.40	3.349	3.400	3.451	109	157	205	63	105	147
3.45	5.45	3.399	3.450	3.501	110	158	206	63	106	149
3.50	5.50	3.448	3.500	3.552	111	159	207	63	106	149
3.55	5.50	3.497	3.550	3.603	112	161	210	64	108	152
3.60	5.50	3.546	3.600	3.654	114	164	214	65	109	153

TEST CIRCUITS

< Circuit No.① >

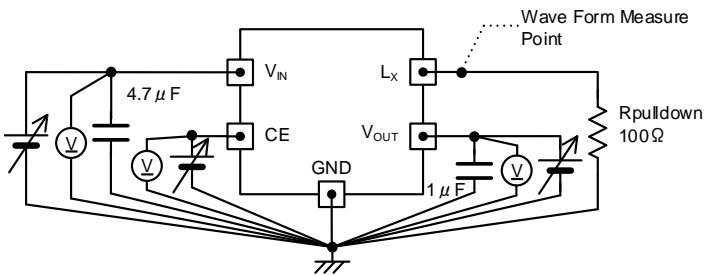

< Circuit No.② >

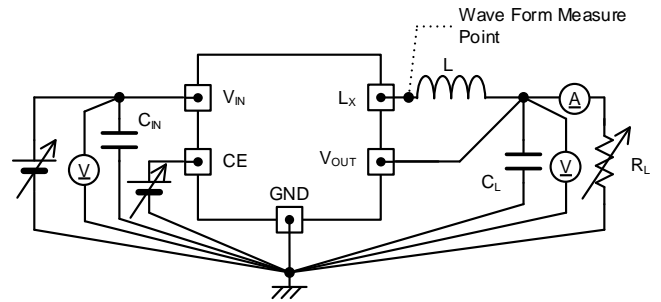

※ External Components
 L : 0.47 μH
 C_{IN} : 4.7 μF (ceramic)
 C_L : 4.7 μF (ceramic)

< Circuit No.③ >

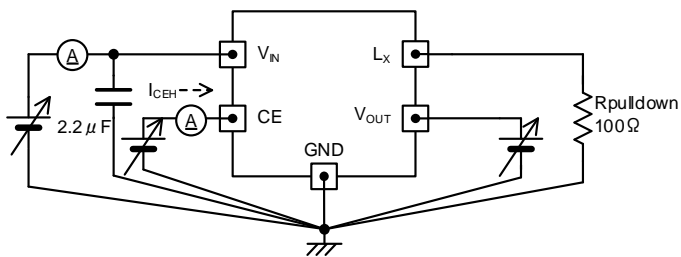

< Circuit No.④ >

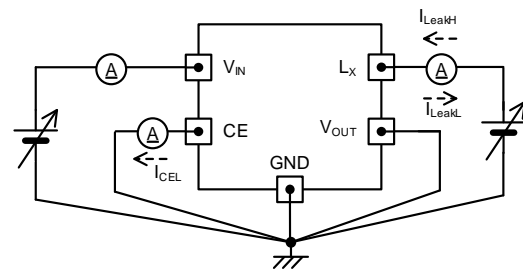

< Circuit No.⑤ >

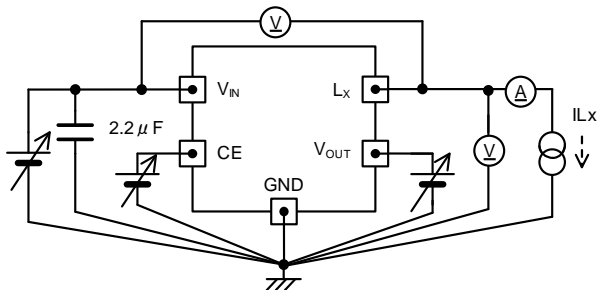

< Circuit No.⑥ >

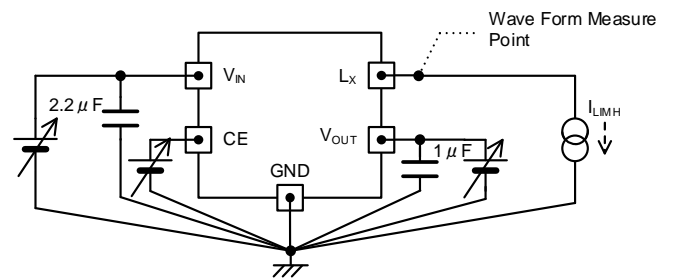

< Circuit No.⑦ >
 B TYPE

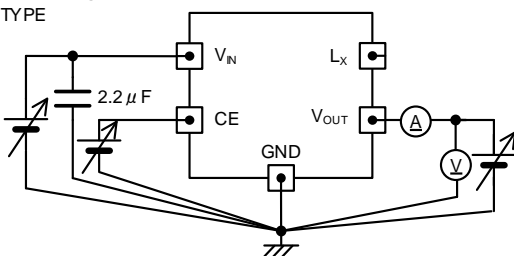

TYPICAL APPLICATION CIRCUIT

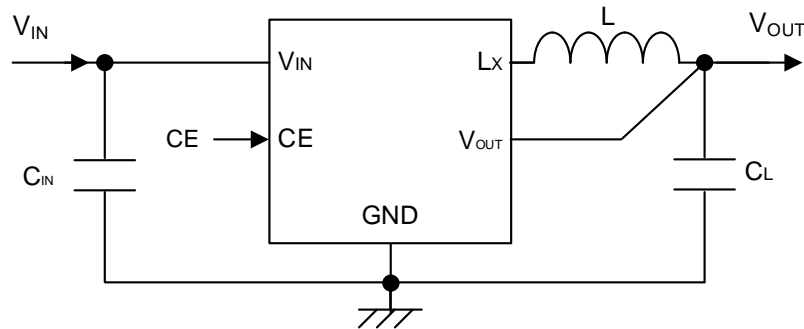

【Typical Examples】 $f_{osc}=4.0\text{MHz}$

	MANUFACTURER	PRODUCT NUMBER	VALUE	SIZE(LxWxT)
L	TAIYO YUDEN	MCEE1005T1R0MHN	1.0uH	1.0x0.5x0.55(mm)
		MCEE1005TR47MHN	0.47uH	1.0x0.5x0.55(mm)
	TDK	TFM160808ALC-1R0MTAA	1.0uH	1.6x0.8x0.8(mm)
	murata	DFE18SAN1R0MG0L	1.0μH	1.6x0.8x1.0(mm)
		DFE18SANR47MG0L	0.47μH	1.6x0.8x1.0(mm)
		DFE201210U-2R2M	2.2uH	2.0x1.2x1.0(mm)

【Typical Examples】 $f_{osc}=6.0\text{MHz}$

	MANUFACTURER	PRODUCT NUMBER	VALUE	SIZE(LxWxT)
L	TAIYO YUDEN	MCEE1005TR47MHN	0.47uH	1.0x0.5x0.55(mm)
		MCEE1005T1R0MHN	1.0uH	1.0x0.5x0.55(mm)
	FDK	MIPSCZ1005DR47T	0.47μH	1.0x0.5x0.75(mm)
	murata	DFE18SANR47MG0L	0.47μH	1.6x0.8x1.0(mm)
		DFE18SAN1R0MG0L	1.0μH	1.6x0.8x1.0(mm)

【Typical Examples】^(*)

	MANUFACTURER	PRODUCT NUMBER	VALUE	SIZE(LxWxT)
$C_{IN}^{(*)2}$	murata	GRM035R60J475ME15	4.7μF/6.3V	0.6x0.3x0.5(mm)
	TDK	C1005X5R0J225M050BC	2.2μF/6.3V	1.0x0.5x0.5(mm)
	TAIYO YUDEN	LMK105BJ225KV	2.2μF/10V	1.0x0.5x0.5(mm)
C_L	murata	GRM035R60J475ME15	4.7μF/6.3V	0.6x0.3x0.5(mm)
	TDK	C1005X5R0J475M050BC	4.7μF/6.3V	1.0x0.5x0.5(mm)

^(*) Select components appropriate to the usage conditions (ambient temperature, input & output voltage).

^{(*)2} Please increase a by-pass capacitor as needed.

OPERATIONAL EXPLANATION

This IC consists of a reference voltage source, error amplifier, comparator, phase compensation, on time generation circuit, output voltage adjustment resistors, current limiter circuit, UVLO circuit, PWM/PFM selection circuit and so on.

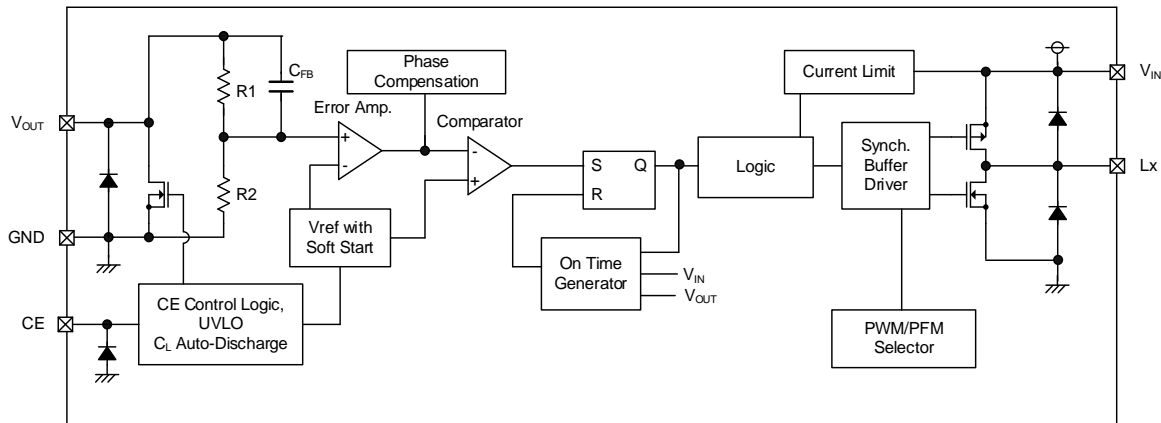

BLOCK DIAGRAM (XC9281/XC9282 Series Type B)

The control method is HiSAT-COT (High Speed circuit Architecture for Transient with Constant On Time), which features the On time control method and the fast transient response with low ripple voltage.

<Normal operation>

In HiSAT-COT control, ON time (t_{ON}) dependent on input voltage and output voltage is generated and Pch MOS driver Tr. Is turned on. On time is set as follows.

$$\begin{aligned} \text{IC with 4MHz : } t_{ON} &= (V_{OUT} / V_{IN}) \times 250\text{ns} \\ \text{IC with 6MHz : } t_{ON} &= (V_{OUT} / V_{IN}) \times 167\text{ns} \end{aligned}$$

The off time (t_{OFF}) is controlled by comparing the output voltage and the reference voltage with the error amplifier and the comparator. Specifically, the reference voltage and a voltage which is obtained by dividing the output voltage with R1 and R2 are compared with using the error amplifier, apply phase compensation to the output of the error amplifier, and send it to the comparator. In the comparator, the output of the error amplifier is compared with the reference voltage, and when it falls below the reference voltage, the SR latch is set and it becomes the ON period again.

The XC9281 series (PWM control) operates in continuous conduction mode and operates at a stable oscillation frequency regardless of the load. The oscillation frequency can be obtained by the following equation.

$$f_{osc} = (V_{OUT} / V_{IN}) \times (1 / t_{ON})$$

The XC9282 series (PWM/PFM automatic switching control) lowers the oscillation frequency at light load by operating in discontinuous conduction mode at light load. By this operation, it is possible to reduce switching loss at light load and achieve high efficiency from light load to heavy load.

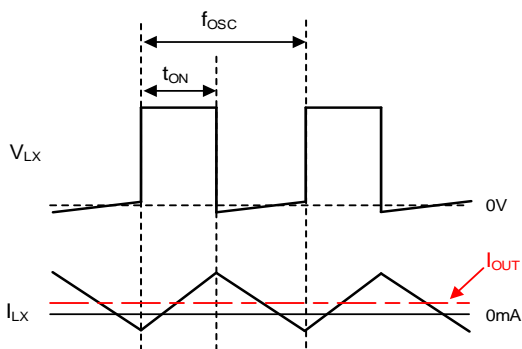

Continuous Conduction Mode waveform

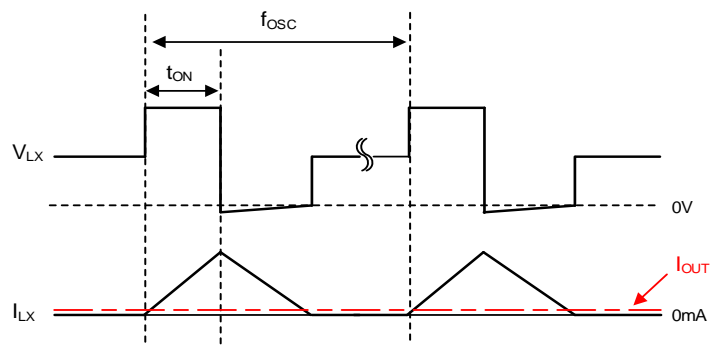

Discontinuous Conduction Mode waveform

In the phase compensation circuit, the frequency characteristic of the error amplifier is optimized, and ramp waves which are similar to ripple voltages generated at the output are generated to modulate the output signal of the error amplifier. This enables a stable feedback system to be obtained even when a low ESR capacitor such as a ceramic capacitor is used, and a fast transient response and stabilization of the output voltage are achieved.

■ OPERATIONAL EXPLANATION (Continued)

<100% Duty cycle mode>

In conditions where the input-output voltage difference is small or transient response, the Pch MOS driver transistor might keep on turning on and the 100% duty cycle mode might be set. The 100% duty cycle mode achieves high output voltage stability and high-speed response even under full load conditions and the condition where the input-output voltage difference is small.

<CE function>

When "H" voltage (V_{CEH}) is fed to the CE pin, normal operation starts after raising the output voltage with the soft start function. When the "L" voltage (V_{CEL}) is fed to the CE pin, it enters the standby state and the current consumption is suppressed to $0\mu\text{A}$ (TYP.). Additionally, Pch MOS driver transistor and Nch MOS driver transistor are turned off.

<Soft-Start function>

It is a function to raise the output voltage gradually and suppress inrush current. After the "H" voltage (V_{CEH}) is fed to the CE pin, the reference voltage which is connected to the error amplifier increases linearly during the soft start period. As a result, the output voltage increases in proportion to the increase of the reference voltage. This operation can prevent a large inrush current and smoothly raise the output voltage.

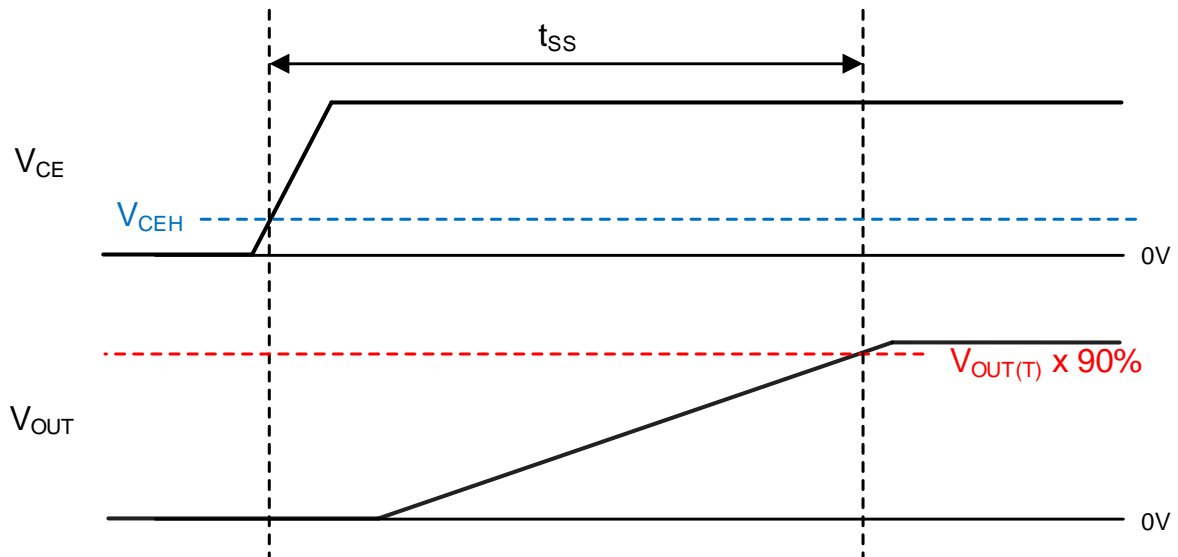

■ OPERATIONAL EXPLANATION(Continued)

<UVLO function>

When the V_{IN} voltage becomes 2.0V (TYP.) or less, the UVLO function operates to forcibly turn off the Pch MOS driver transistor to prevent erroneous pulse output due to operation instability of the internal circuit. When the V_{IN} voltage becomes 2.1V (TYP.) or more, the UVLO function is canceled. After the UVLO function is canceled, the output voltage rises with the soft start function, and then the normal operation is performed. Moreover, during the UVLO operation, the internal circuit is operating because stopping by UVLO is not same to a standby mode and just switching operation is stopped.

<CL Discharge function>

B type can discharge in a fast manner the output capacitor by internal Nch MOS transistor connected to V_{OUT} pin in order to prevent malfunction of application due to charge remaining in output capacitor during standby. The output voltage during discharging can be calculated by the following equation.

$$V = V_{OUT(T)} \times e^{-t/\tau}$$

$$t = \tau \ln(V_{OUT(T)} / V)$$

- V : Output voltage during discharge
- $V_{OUT(T)}$: Output voltage
- t : Discharge time
- C_L : Effective capacitance of Output capacitor
- R_{DCHG} : C_L auto-discharge resistance
- τ : $C_L \times R_{DCHG}$

Output Voltage Discharge characteristics

$R_{DCHG} = 145\Omega$ (TYP.), $C_L = 4.7\mu F$

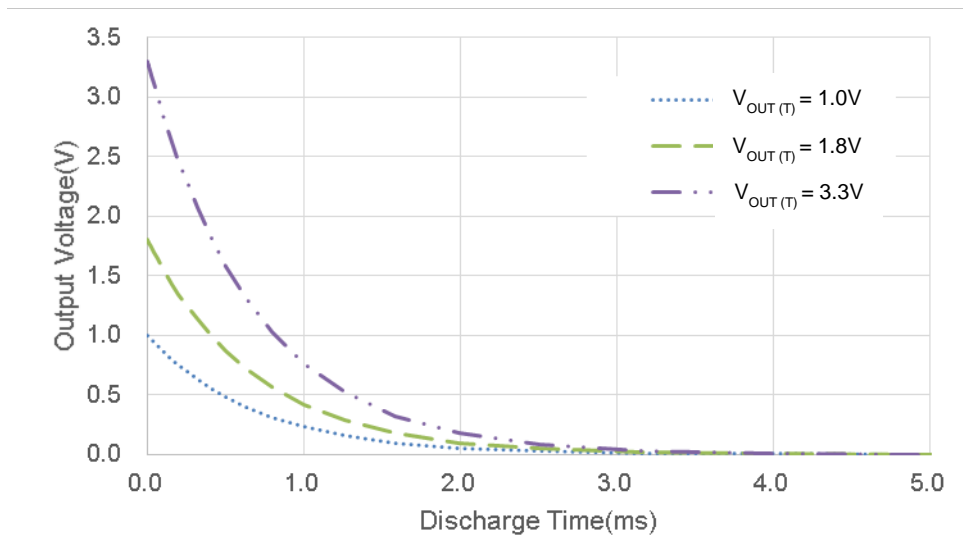

OPERATIONAL EXPLANATION(Continued)

<Current Limit>

The current limit function monitors a current flowing through Pch MOS driver transistor and Nch MOS driver transistor and limits the current. The operation at overcurrent is as follows.

- 1) When the current flowing through the Pch MOS driver transistor increases and reaches the current limit value $I_{LIMH}=1000\text{mA}$ (TYP.), the current limit state is set and the Pch MOS driver transistor is forcibly turned off.
- 2) The Nch MOS driver transistor turns on after turning off the Pch MOS driver transistor by the current limit function. The Pch MOS driver transistor is prohibited to turn on until the current value flowing through the Nch MOS driver transistor drops to $I_{LIML}=800\text{mA}$ (TYP.).
- 3) Repeat the operations 1) and 2) during the current limit state.
- 4) When the current limit state is canceled, it automatically returns to normal operation.

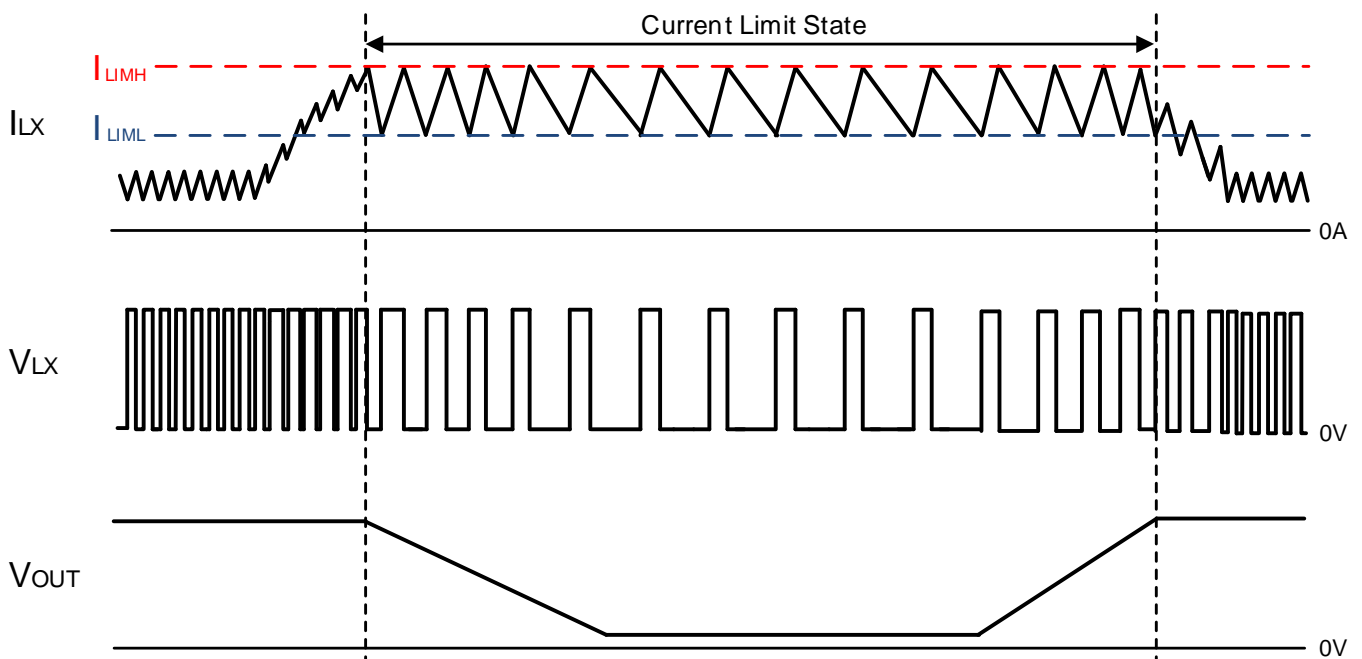

■ NOTE ON USE

- 1) For the phenomenon of temporal and transitional voltage decrease or voltage increase, the IC may be damaged or deteriorated if IC is used beyond the absolute MAX. specifications.
- 2) Spike noise and ripple voltage arise in a switching regulator as with a DC/DC converter. These are greatly influenced by external component selection, such as the coil inductance, capacitance values, and board layout of external components. Once the design has been completed, verification with actual components should be done.
- 3) The DC/DC converter characteristics depend greatly on the externally connected components as well as on the characteristics of this IC, so refer to the specifications and standard circuit examples of each component when carefully considering which components to select. Be especially careful of the capacitor characteristics and use B characteristics (JIS standard) or X7R, X5R (EIA standard) ceramic capacitors.
Duty might not be stable when the capacity is insufficient due to high temperature or low temperature, or derating of C_L capacitance happens due to DC bias, etc. Please increase C_L as necessary.
- 4) A feature of HiSAT-COT control is that it controls the off time in order to control the duty, which varies due to the effects of power loss. In addition, changes in the on time due to 100% duty cycle mode are allowed. For this reason, caution must be exercised as the characteristics of the switching frequency will vary depending on the external component characteristics, board layout, input voltage, output voltage, load current and other parameters.
- 5) Due to propagation delay inside the product, the on time generated by the on time generation circuit is not the same as the on time that is the ratio of the input voltage to the output voltage.
- 6) With regard to the current limiting value, the actual coil current may at times exceed the electrical characteristics due to propagation delay inside the product.
- 7) The CE pin is a CMOS input pin. Please do not open it. When it connected to either VIN pin or GND pin, it is recommended to connect a resistor of up to 1M Ω to prevent malfunction of this product and the device connected to the input / output due to short between pins.
- 8) The XC9282 series would be in a discontinuous conduction mode at light load, but if the inductance value of the coil is smaller than the standard value, the coil current will flow back at the time of light load, pulse skipping will not be possible and the efficiency might be deteriorated.
- 9) When a coil with poor DC superimposition characteristics is used, it may not be possible to draw a current of $I_{out}=600\text{mA}$ at high temperatures. In this case, either change the coil to one with a large inductance value or use a coil with better DC superimposition characteristics.
- 10) In the XC9282 series, if the step-down difference is small or large, the output voltage might decrease in the heavy load region. Please use XC9281 series when load stability is important.

NOTE ON USE (Continued)

11) In the XC9282 series, decrease of the output voltage, as mentioned in the "NOTE ON USE (10)", can occur periodically in the vicinity of 100% Duty cycle mode switching point in the heavy load region and can increase the ripple voltage.

Please use the XC9281 series when you see the output voltage fluctuation as important.

(See diagram below.)

<Conditions>

XC9282B12D ($V_{OUT}=1.2V$, $f_{osc}=4MHz$)

$T_a=25^{\circ}C$, $V_{IN}=2.5V$, $I_{out}=500mA$

L: 1.0uH (MCEE1005T1R0MHN)

C_{IN} : 0.47uF (GRM035R60J475ME15)

C_L : 0.47uF (GRM035R60J475ME15)

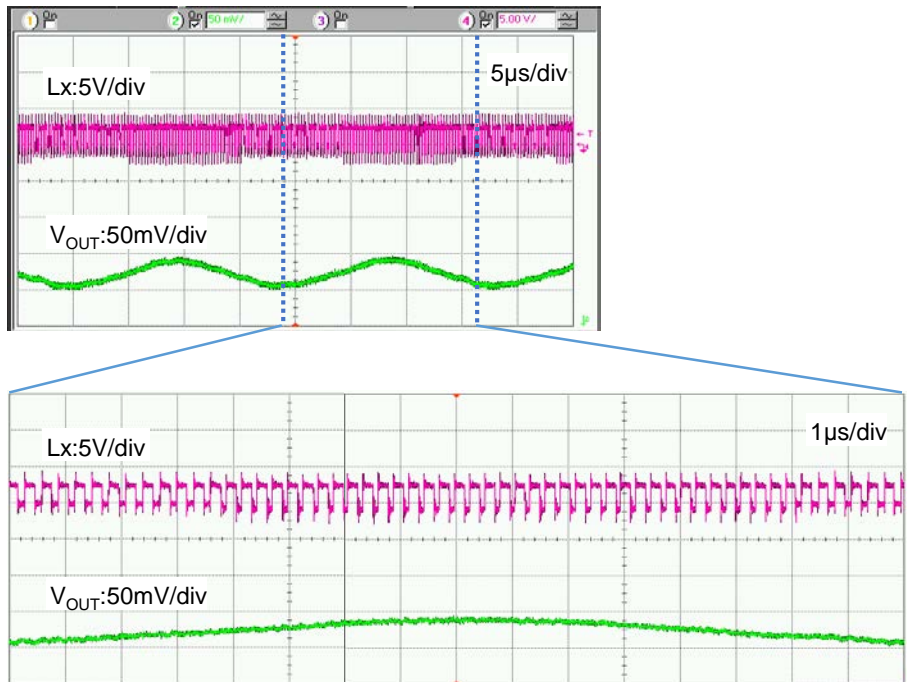

Fig Unstable operation in heavy load

12) Torex places an importance on improving our products and their reliability. We request that users incorporate fail-safe designs and post-aging protection treatment when using Torex products in their systems.

13) Instructions of pattern layouts

- (1) If the wiring impedance is high, noise wraparound due to the output current and phase deviation are likely to occur, and the operation might become unstable. Please mount peripheral parts as close to IC as possible.
- (2) In order to stabilize V_{IN} pin voltage level, we recommend that a by-pass capacitor (C_{IN}) be connected as close as possible to the V_{IN} pin, GND pin.
- (3) Wire external components as close to the IC as possible and use thick, short connecting traces to reduce the circuit impedance.
- (4) Fluctuations in the GND potential due to the GND current during switching might cause the IC operation to become unstable. Please strengthen the GND wiring sufficiently.
- (5) This series' internal driver transistors bring on heat because of the output current and ON resistance of Pch and Nch MOS driver transistors. Please consider the countermeasures against heat if necessary.

<Reference pattern layout>

WLP-5-06

Layer 1

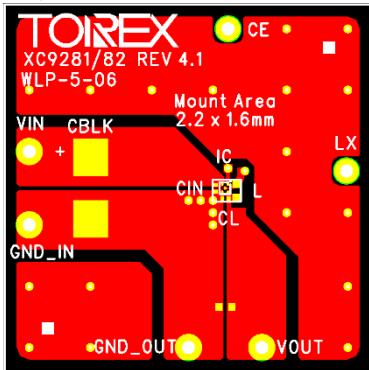

Layer 2

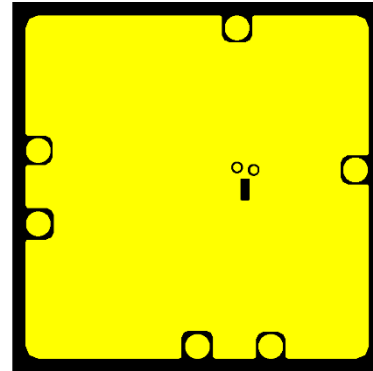

Layer 3

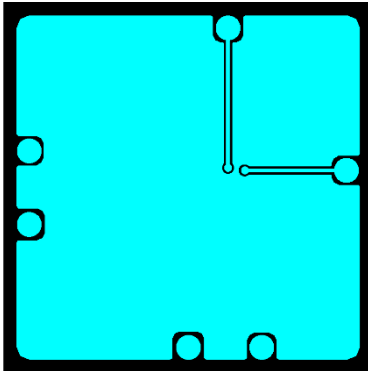

Layer 4

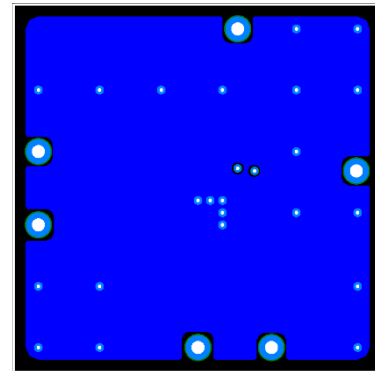

LGA-6B01

Layer 1

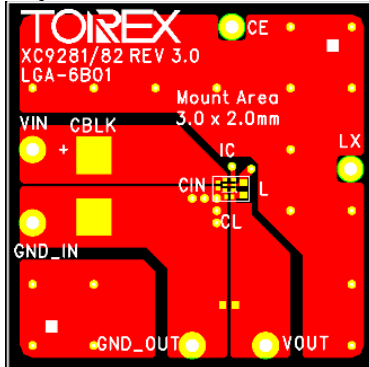

Layer 2

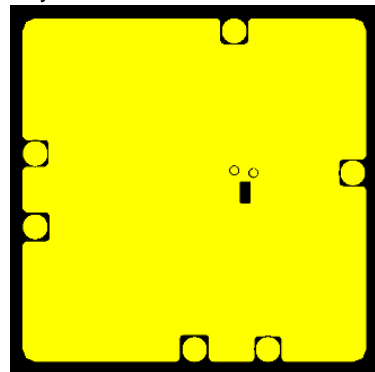

Layer 3

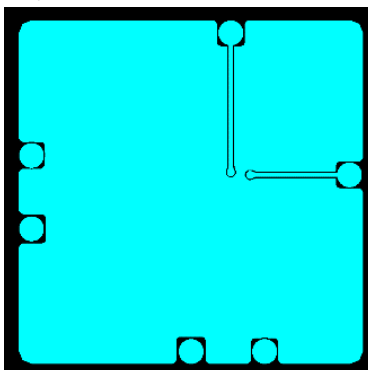

Layer 4

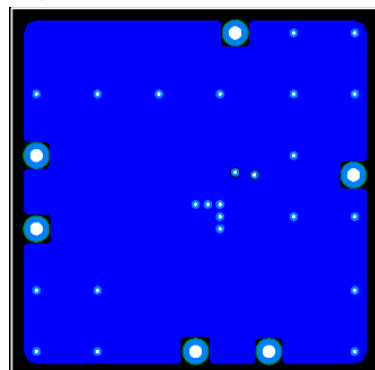

TYPICAL PERFORMANCE CHARACTERISTICS

(1) Efficiency vs. Output Current

XC9281B08E/XC9282B08E ($V_{OUT}=0.8V$, $f_{OSC}=6MHz$)

$L = 0.47\mu H$ (DFE18SANR47MG0L)
 $C_{IN} = 4.7\mu F$ (GRM035R60J475ME15)
 $C_L = 4.7\mu F$ (GRM035R60J475ME15)

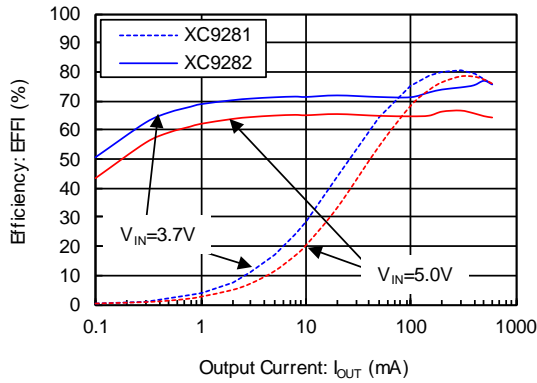

XC9281B08D/XC9282B08D ($V_{OUT}=0.8V$, $f_{OSC}=4MHz$)

$L = 1.0\mu H$ (DFE18SAN1R0MG0L)
 $C_{IN} = 4.7\mu F$ (GRM035R60J475ME15)
 $C_L = 4.7\mu F$ (GRM035R60J475ME15)

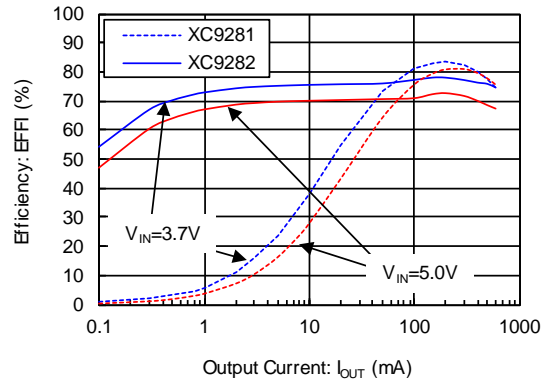

XC9281B10E/XC9282B10E ($V_{OUT}=1.0V$, $f_{OSC}=6MHz$)

$L = 0.47\mu H$ (DFE18SANR47MG0L)
 $C_{IN} = 4.7\mu F$ (GRM035R60J475ME15)
 $C_L = 4.7\mu F$ (GRM035R60J475ME15)

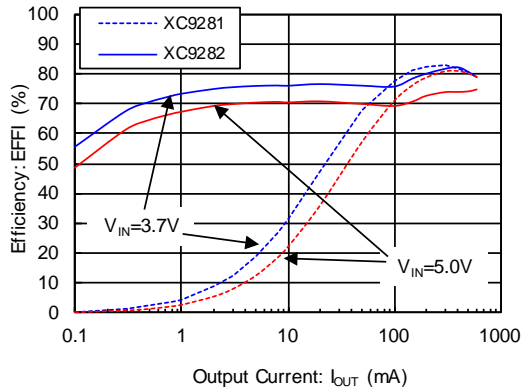

XC9281B10D/XC9282B10D ($V_{OUT}=1.0V$, $f_{OSC}=4MHz$)

$L = 1.0\mu H$ (DFE18SAN1R0MG0L)
 $C_{IN} = 4.7\mu F$ (GRM035R60J475ME15)
 $C_L = 4.7\mu F$ (GRM035R60J475ME15)

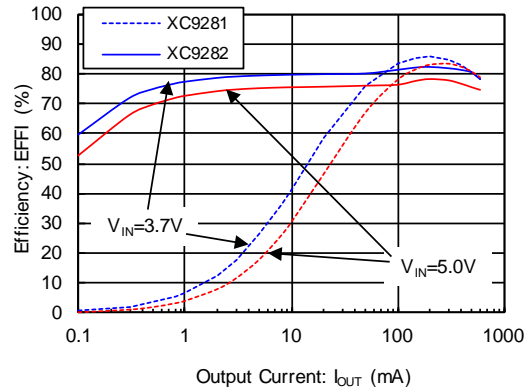

XC9281B18E/XC9282B18E ($V_{OUT}=1.8V$, $f_{OSC}=6MHz$)

$L = 0.47\mu H$ (DFE18SANR47MG0L)
 $C_{IN} = 4.7\mu F$ (GRM035R60J475ME15)
 $C_L = 4.7\mu F$ (GRM035R60J475ME15)

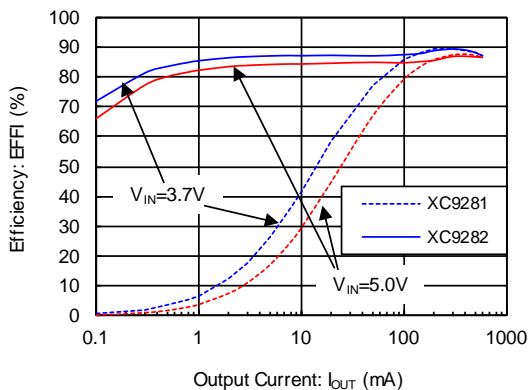

XC9281B18D/XC9282B18D ($V_{OUT}=1.8V$, $f_{OSC}=4MHz$)

$L = 1.0\mu H$ (DFE18SAN1R0MG0L)
 $C_{IN} = 4.7\mu F$ (GRM035R60J475ME15)
 $C_L = 4.7\mu F$ (GRM035R60J475ME15)

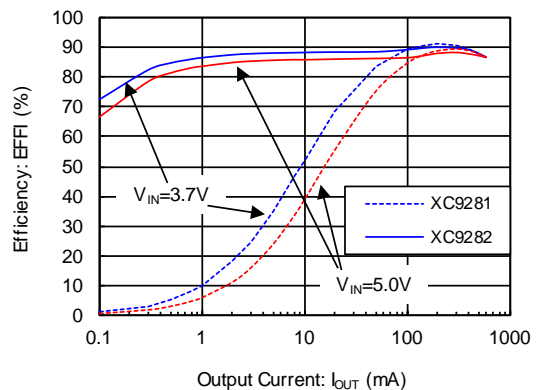

TYPICAL PERFORMANCE CHARACTERISTICS (Continued)

(1) Efficiency vs. Output Current (Continued)

XC9281B33E/XC9282B33E ($V_{OUT}=3.3V$, $f_{OSC}=6MHz$)

$L = 0.47\mu H$ (DFE18SANR47MG0L)
 $C_{IN} = 4.7\mu F$ (GRM035R60J475ME15)
 $C_L = 4.7\mu F$ (GRM035R60J475ME15)

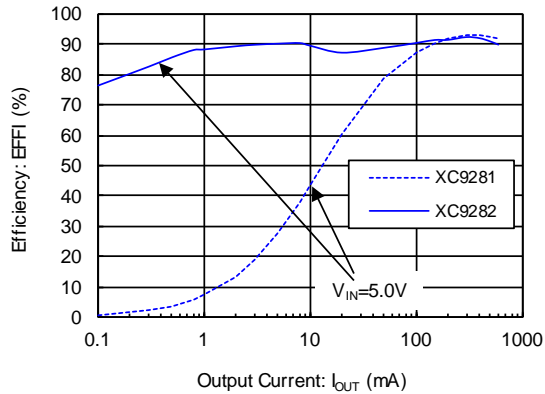

XC9281B33D/XC9282B33D ($V_{OUT}=3.3V$, $f_{OSC}=4MHz$)

$L = 1.0\mu H$ (DFE18SAN1R0MG0L)
 $C_{IN} = 4.7\mu F$ (GRM035R60J475ME15)
 $C_L = 4.7\mu F$ (GRM035R60J475ME15)

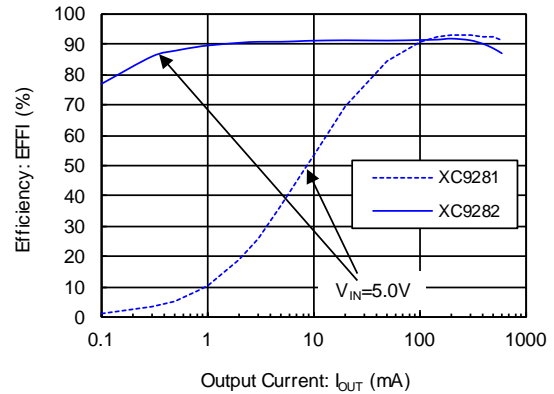

XC9282B18E ($V_{OUT}=1.8V$, $f_{OSC}=6MHz$)

$V_{IN} = 3.7V$
 $C_{IN} = 4.7\mu F$ (GRM035R60J475ME15)
 $C_L = 4.7\mu F$ (GRM035R60J475ME15)

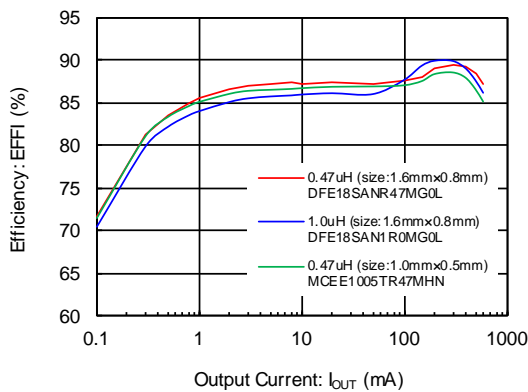

XC9282B18D ($V_{OUT}=1.8V$, $f_{OSC}=4MHz$)

$V_{IN} = 3.7V$
 $C_{IN} = 4.7\mu F$ (GRM035R60J475ME15)
 $C_L = 4.7\mu F$ (GRM035R60J475ME15)

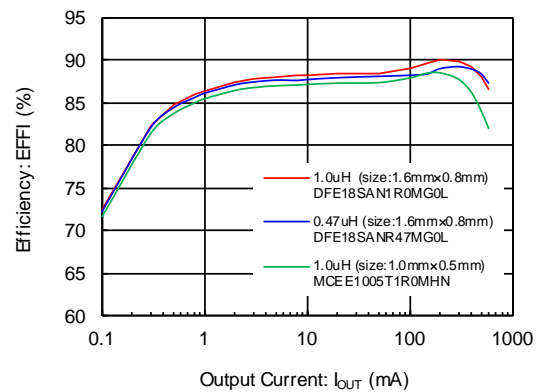

(2) Output Voltage vs. Output Current

XC9281B12E ($V_{OUT}=1.0V$, $f_{OSC}=6MHz$)

$L = 0.47\mu H$ (DFE18SANR47MG0L)
 $C_{IN} = 4.7\mu F$ (GRM035R60J475ME15)
 $C_L = 4.7\mu F$ (GRM035R60J475ME15)

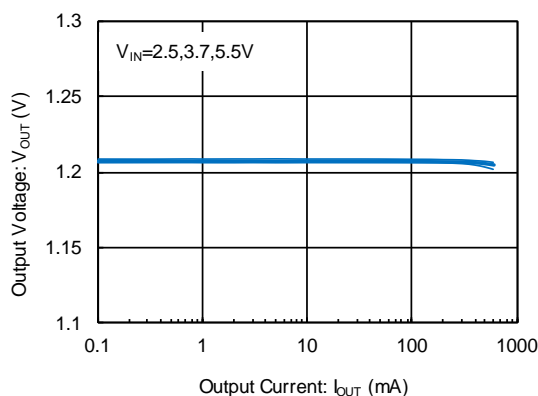

XC9281B12D ($V_{OUT}=1.0V$, $f_{OSC}=4MHz$)

$L = 1.0\mu H$ (DFE18SAN1R0MG0L)
 $C_{IN} = 4.7\mu F$ (GRM035R60J475ME15)
 $C_L = 4.7\mu F$ (GRM035R60J475ME15)

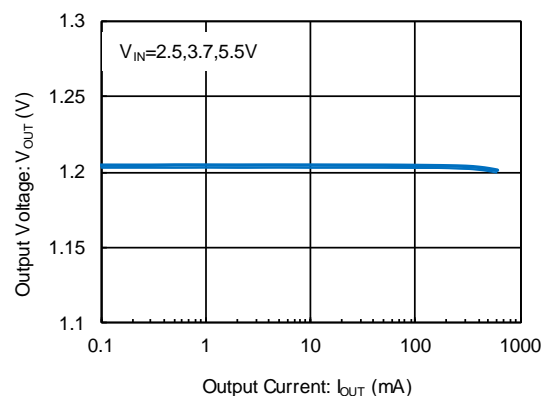

TYPICAL PERFORMANCE CHARACTERISTICS (Continued)

(2) Output Voltage vs. Output Current (Continued)

XC9282B12E ($V_{OUT}=1.2V, f_{OSC}=6MHz$)

$L = 0.47\mu H$ (DFE18SANR47MG0L)
 $C_{IN} = 4.7\mu F$ (GRM035R60J475ME15)
 $C_L = 4.7\mu F$ (GRM035R60J475ME15)

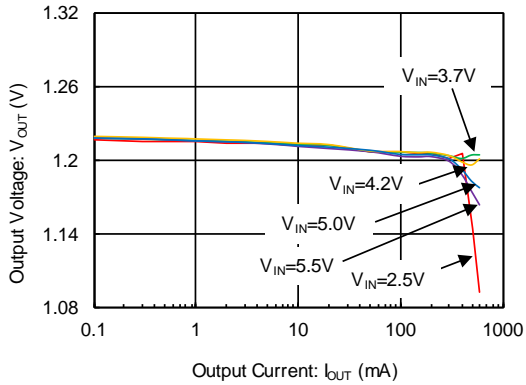

XC9282B12D ($V_{OUT}=1.2V, f_{OSC}=4MHz$)

$L = 1.0\mu H$ (DFE18SAN1R0MG0L)
 $C_{IN} = 4.7\mu F$ (GRM035R60J475ME15)
 $C_L = 4.7\mu F$ (GRM035R60J475ME15)

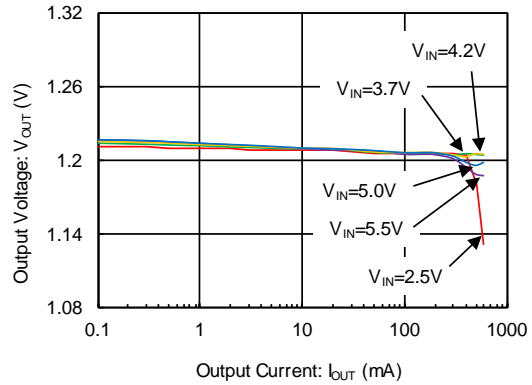

XC9281B18E ($V_{OUT}=1.8V, f_{OSC}=6MHz$)

$L = 0.47\mu H$ (DFE18SANR47MG0L)
 $C_{IN} = 4.7\mu F$ (GRM035R60J475ME15)
 $C_L = 4.7\mu F$ (GRM035R60J475ME15)

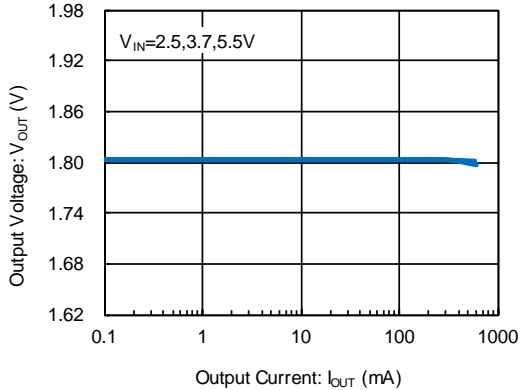

XC9281B18D ($V_{OUT}=1.8V, f_{OSC}=4MHz$)

$L = 1.0\mu H$ (DFE18SAN1R0MG0L)
 $C_{IN} = 4.7\mu F$ (GRM035R60J475ME15)
 $C_L = 4.7\mu F$ (GRM035R60J475ME15)

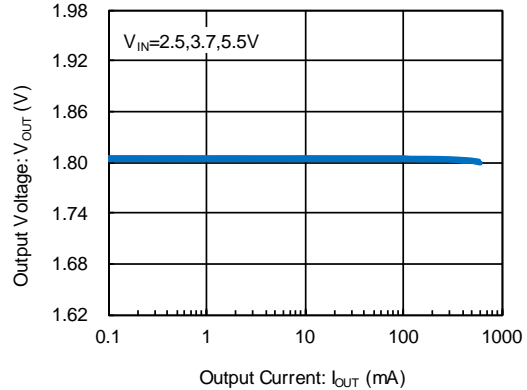

XC9282B18E ($V_{OUT}=1.8V, f_{OSC}=6MHz$)

$L = 0.47\mu H$ (DFE18SANR47MG0L)
 $C_{IN} = 4.7\mu F$ (GRM035R60J475ME15)
 $C_L = 4.7\mu F$ (GRM035R60J475ME15)

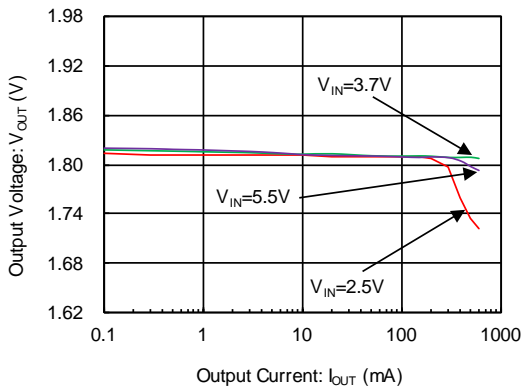

XC9282B18D ($V_{OUT}=1.8V, f_{OSC}=4MHz$)

$L = 1.0\mu H$ (DFE18SAN1R0MG0L)
 $C_{IN} = 4.7\mu F$ (GRM035R60J475ME15)
 $C_L = 4.7\mu F$ (GRM035R60J475ME15)

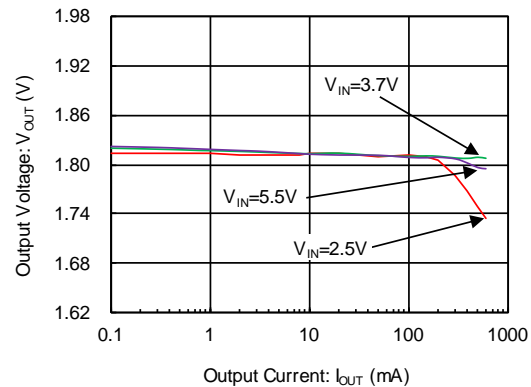

TYPICAL PERFORMANCE CHARACTERISTICS (Continued)

(2) Output Voltage vs. Output Current (Continued)

XC9281B33E ($V_{OUT}=3.3V$, $f_{OSC}=6MHz$)

$L = 0.47\mu H$ (DFE18SANR47MG0L)
 $C_{IN} = 4.7\mu F$ (GRM035R60J475ME15)
 $C_L = 4.7\mu F$ (GRM035R60J475ME15)

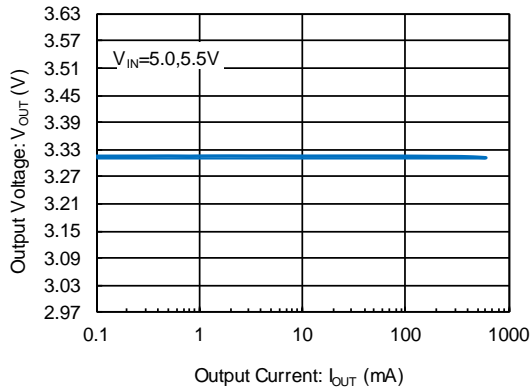

XC9281B33D ($V_{OUT}=3.3V$, $f_{OSC}=4MHz$)

$L = 1.0\mu H$ (DFE18SAN1R0MG0L)
 $C_{IN} = 4.7\mu F$ (GRM035R60J475ME15)
 $C_L = 4.7\mu F$ (GRM035R60J475ME15)

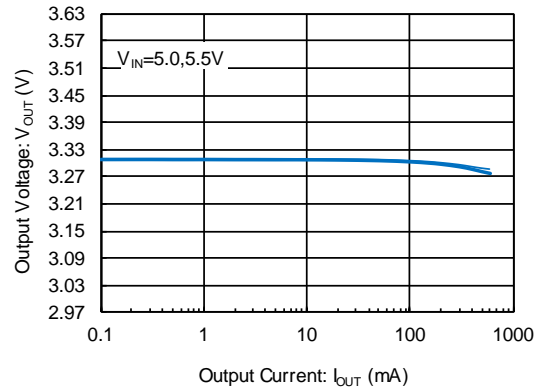

XC9282B33E ($V_{OUT}=3.3V$, $f_{OSC}=6MHz$)

$L = 0.47\mu H$ (DFE18SANR47MG0L)
 $C_{IN} = 4.7\mu F$ (GRM035R60J475ME15)
 $C_L = 4.7\mu F$ (GRM035R60J475ME15)

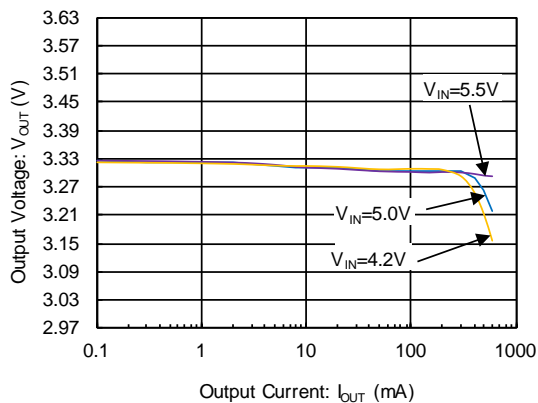

XC9282B33D ($V_{OUT}=3.3V$, $f_{OSC}=4MHz$)

$L = 1.0\mu H$ (DFE18SAN1R0MG0L)
 $C_{IN} = 4.7\mu F$ (GRM035R60J475ME15)
 $C_L = 4.7\mu F$ (GRM035R60J475ME15)

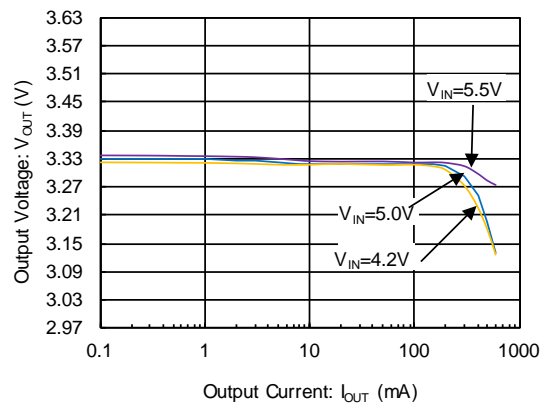

(3) Ripple Voltage vs. Output Current

XC9281B10E/XC9282B10E ($V_{OUT}=1.0V$, $f_{OSC}=6MHz$)

$L = 0.47\mu H$ (DFE18SANR47MG0L)
 $C_{IN} = 4.7\mu F$ (GRM035R60J475ME15)
 $C_L = 4.7\mu F$ (C1005X5R0J475M050BC)

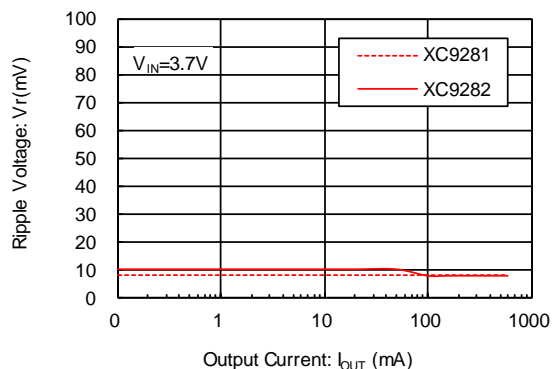

XC9281B10D/XC9282B10D ($V_{OUT}=1.0V$, $f_{OSC}=4MHz$)

$L = 1.0\mu H$ (DFE18SAN1R0MG0L)
 $C_{IN} = 4.7\mu F$ (GRM035R60J475ME15)
 $C_L = 4.7\mu F$ (C1005X5R0J475M050BC)

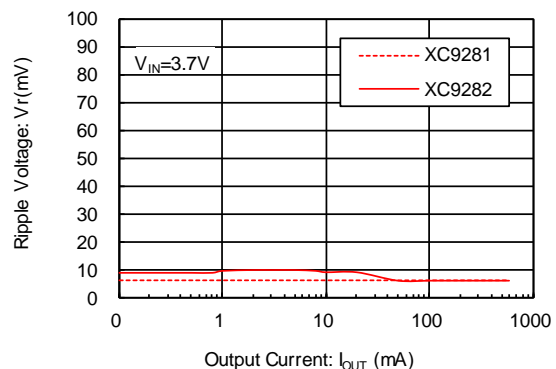

TYPICAL PERFORMANCE CHARACTERISTICS (Continued)

(3) Ripple Voltage vs. Output Current (Continued)

XC9281B18E/XC9282B18E ($V_{OUT}=1.8V$, $f_{OSC}=6MHz$)
 $L = 0.47\mu H$ (DFE18SANR47MG0L)
 $C_{IN} = 4.7\mu F$ (GRM035R60J475ME15)
 $C_L = 4.7\mu F$ (C1005X5R0J475M050BC)

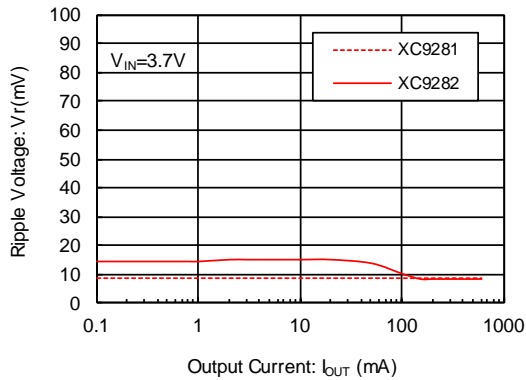

XC9281B18D/XC9282B18D ($V_{OUT}=1.8V$, $f_{OSC}=4MHz$)
 $L = 1.0\mu H$ (DFE18SAN1R0MG0L)
 $C_{IN} = 4.7\mu F$ (GRM035R60J475ME15)
 $C_L = 4.7\mu F$ (C1005X5R0J475M050BC)

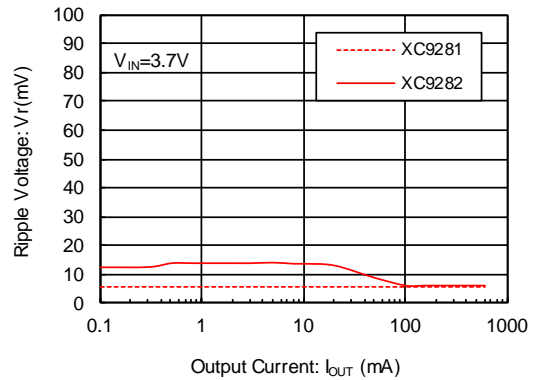

XC9281B33E/XC9282B33E ($V_{OUT}=3.3V$, $f_{OSC}=6MHz$)
 $L = 0.47\mu H$ (DFE18SANR47MG0L)
 $C_{IN} = 4.7\mu F$ (GRM035R60J475ME15)
 $C_L = 4.7\mu F$ (C1005X5R0J475M050BC)

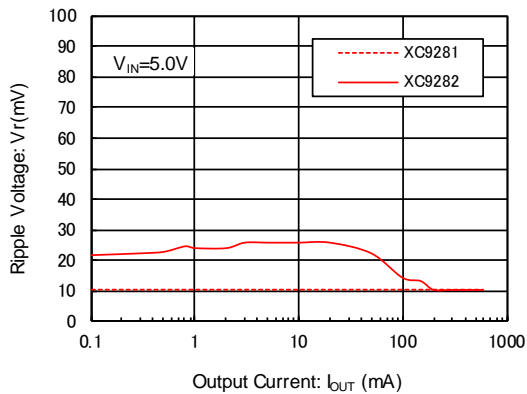

XC9281B33D/XC9282B33D ($V_{OUT}=3.3V$, $f_{OSC}=4MHz$)
 $L = 1.0\mu H$ (DFE18SAN1R0MG0L)
 $C_{IN} = 4.7\mu F$ (GRM035R60J475ME15)
 $C_L = 4.7\mu F$ (C1005X5R0J475M050BC)

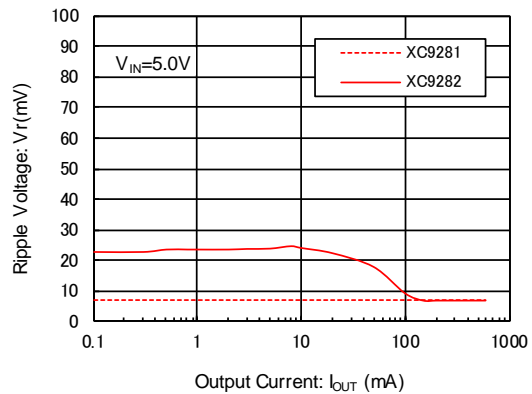

(4) Output Voltage vs. Ambient Temperature

XC9281B18E/XC9281B18D ($V_{OUT}=1.8V$)

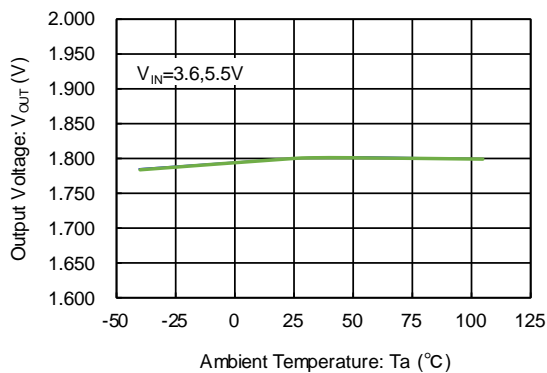

(5) UVLO Voltage vs. Ambient Temperature

XC9281B18E/XC9281B18D ($V_{OUT}=1.8V$)

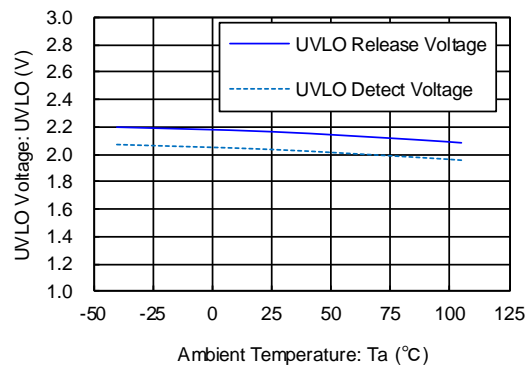

TYPICAL PERFORMANCE CHARACTERISTICS (Continued)

(6) Quiescent Current vs. Ambient Temperature

XC9281B18E/XC9281B18D($V_{OUT}=1.8V$)

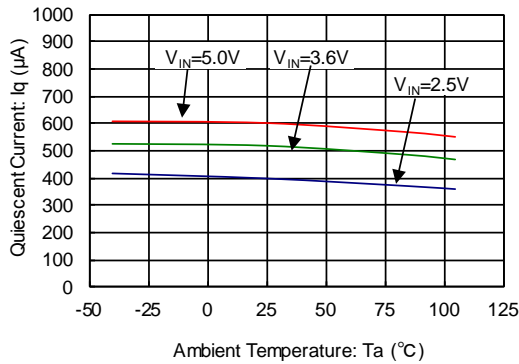

XC9282B18E/XC9282B18D($V_{OUT}=1.8V$)

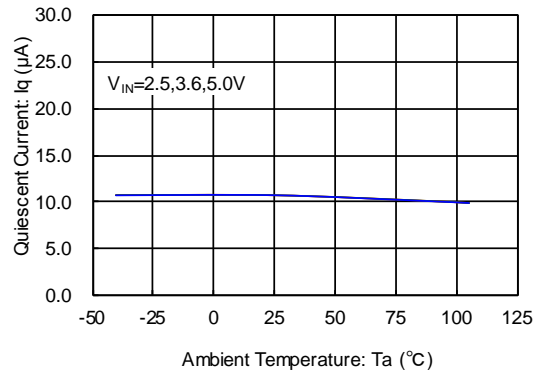

(7) Stand-by Current vs. Ambient Temperature

XC9282B18E/XC9282B18D($V_{OUT}=1.8V$)

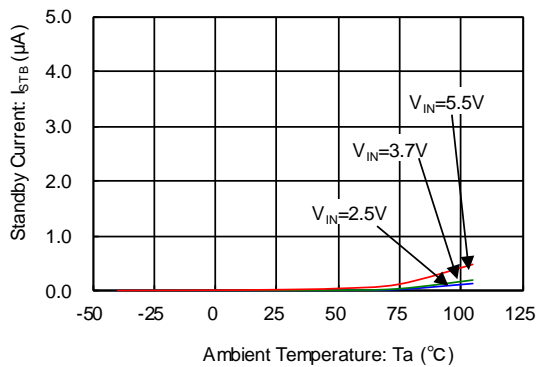

(8) Oscillation Frequency vs. Output Current

XC9281B08E($V_{OUT}=0.8V$, $f_{OSC}=6MHz$)

$L = 0.47\mu H$ (DFE18SANR47MG0L)
 $C_{IN} = 4.7\mu F$ (GRM035R60J475ME15)
 $C_L = 4.7\mu F$ (GRM035R60J475ME15)

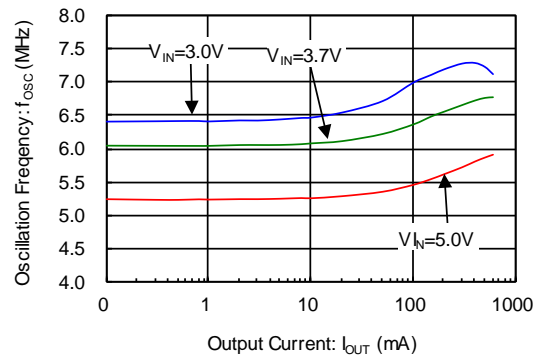

XC9281B18E($V_{OUT}=1.8V$, $f_{OSC}=6MHz$)

$L = 0.47\mu H$ (DFE18SANR47MG0L)
 $C_{IN} = 4.7\mu F$ (GRM035R60J475ME15)
 $C_L = 4.7\mu F$ (GRM035R60J475ME15)

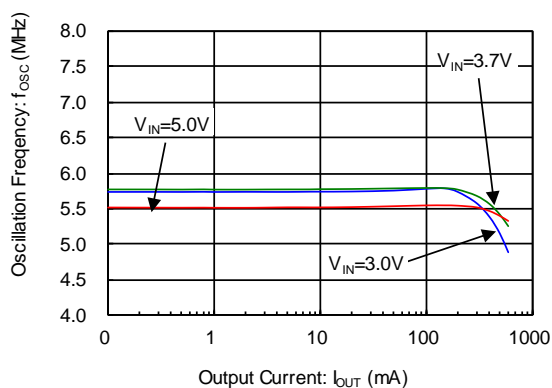

XC9281B33E($V_{OUT}=3.3V$, $f_{OSC}=6MHz$)

$L = 0.47\mu H$ (DFE18SANR47MG0L)
 $C_{IN} = 4.7\mu F$ (GRM035R60J475ME15)
 $C_L = 4.7\mu F$ (GRM035R60J475ME15)

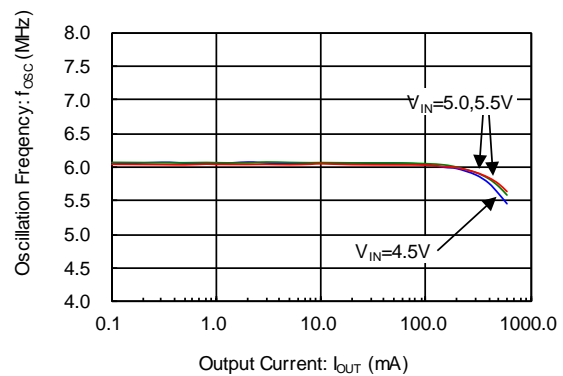

TYPICAL PERFORMANCE CHARACTERISTICS (Continued)

(8) Oscillation Frequency vs. Output Current (Continued)

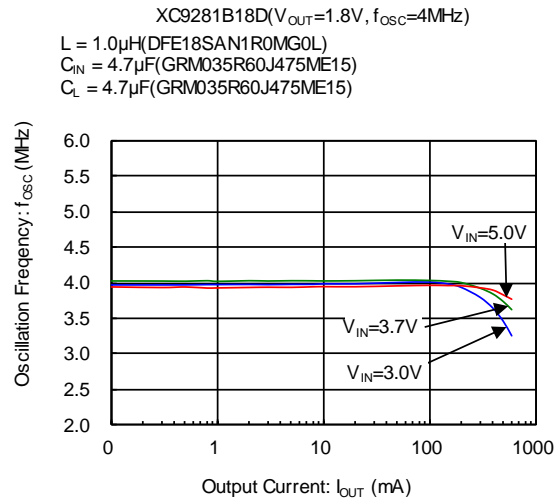
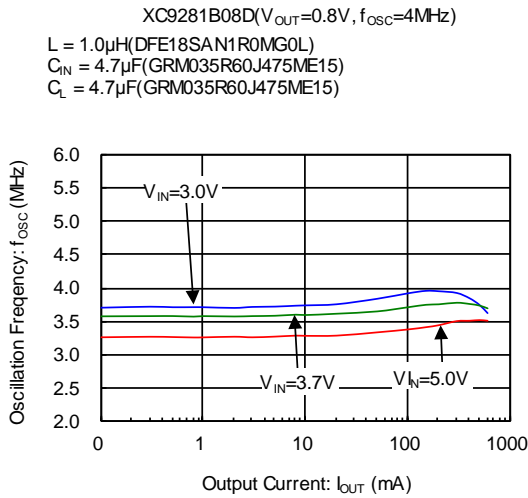

(9) Pch Driver ON Resistance vs. Ambient Temperature

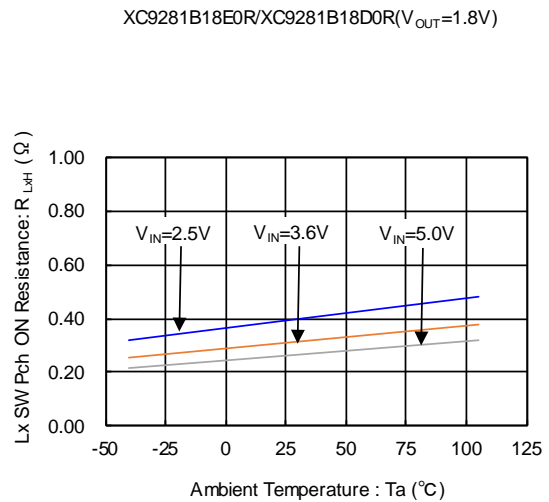
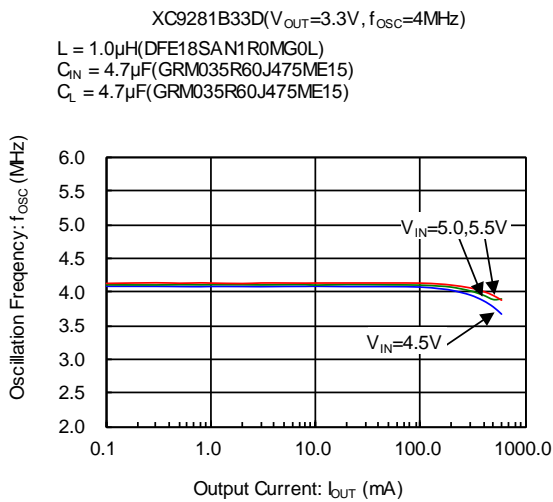

(10) Nch Driver ON Resistance vs. Ambient Temperature

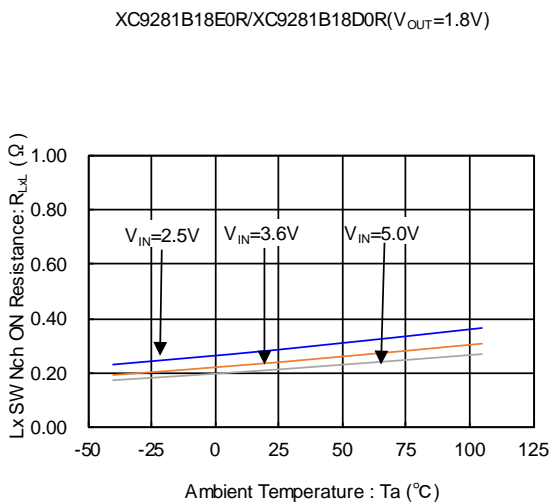

(11) LxSW"H" Leakage Current vs. Ambient Temperature

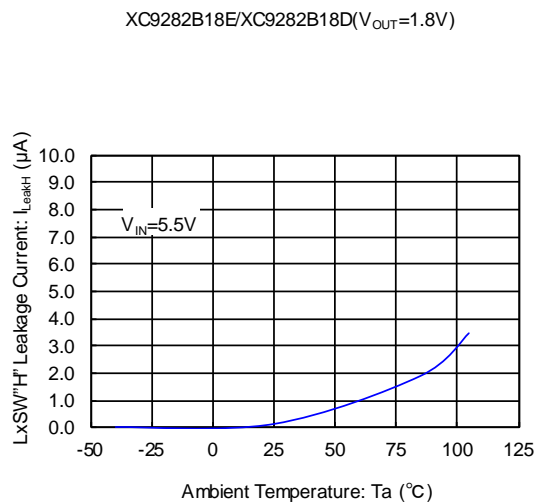

■ TYPICAL PERFORMANCE CHARACTERISTICS (Continued)

(12) LxSW"L" Leakage Current vs. Ambient Temperature

XC9282B18E/XC9282B18D(V_{OUT}=1.8V)

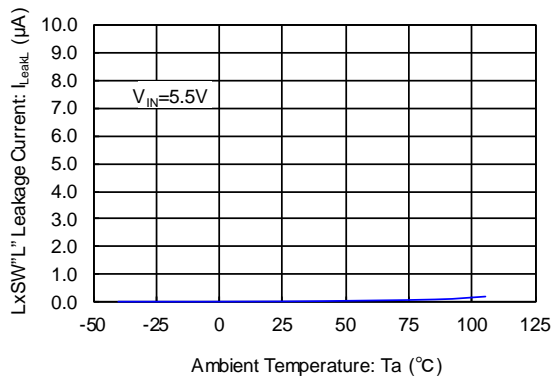

(13) CE"H" Voltage vs. Ambient Temperature

XC9282B18E/XC9282B18D(V_{OUT}=1.8V)

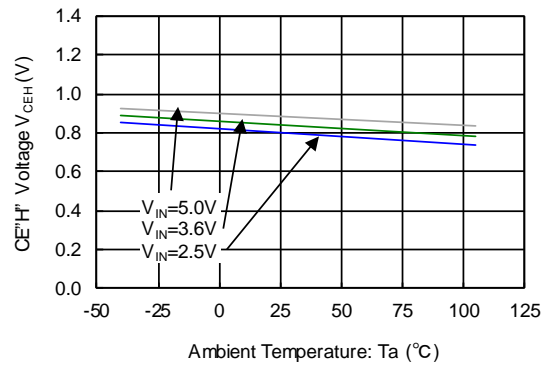

(14) CE"L" Voltage vs. Ambient Temperature

XC9282B18E/XC9282B18D(V_{OUT}=1.8V)

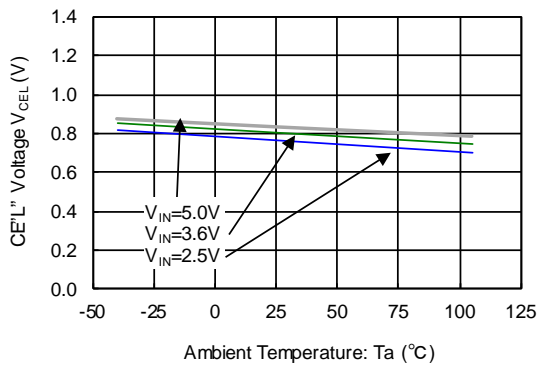

(15) Current Limit vs. Ambient Temperature

XC9281B18E/XC9281B18D(V_{OUT}=1.8V)

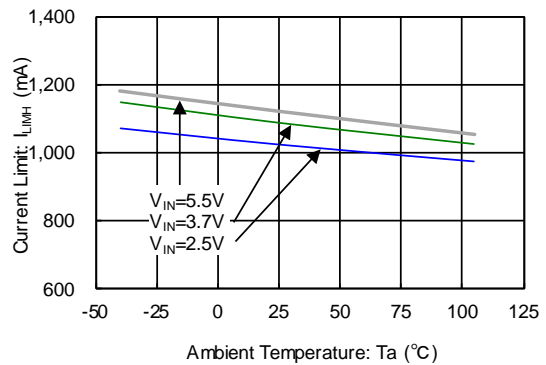

(16) Soft-Start Time vs. Ambient Temperature

XC9282B18E/XC9282B18D(V_{OUT}=1.8V)

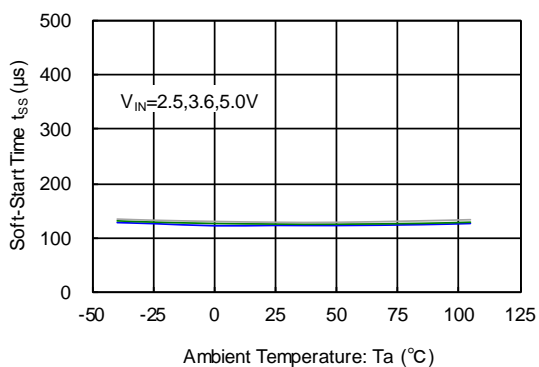

(17) C_L Discharge Resistance vs. Ambient Temperature

XC9282B18E/XC9282B18D(V_{OUT}=1.8V)

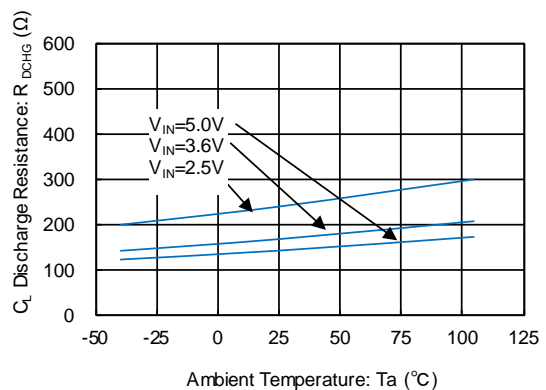

TYPICAL PERFORMANCE CHARACTERISTICS (Continued)

(18) Load Transient Responses

XC9281B10E ($V_{OUT} = 1.0V, f_{OSC} = 6MHz$)
 $V_{IN} = 5.0V$
 $I_{OUT} = 1mA \leftrightarrow 300mA$ ($t_r, t_f = 5\mu s$)
 $L = 0.47\mu H$ (MIPSCZ1005DR47T)
 $C_{IN} = 4.7\mu F$ (GRM035R60J475ME15)
 $C_L = 4.7\mu F$ (C1005X5R0J475M050BC)

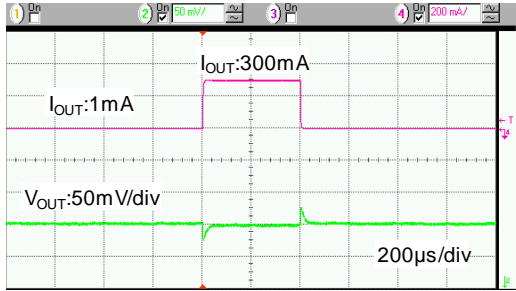

XC9282B10E ($V_{OUT} = 1.0V, f_{OSC} = 6MHz$)
 $V_{IN} = 5.0V$
 $I_{OUT} = 1mA \leftrightarrow 300mA$ ($t_r, t_f = 5\mu s$)
 $L = 0.47\mu H$ (MIPSCZ1005DR47T)
 $C_{IN} = 4.7\mu F$ (GRM035R60J475ME15)
 $C_L = 4.7\mu F$ (C1005X5R0J475M050BC)

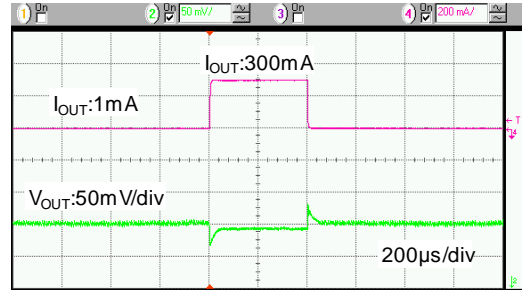

XC9281B18E ($V_{OUT} = 1.8V, f_{OSC} = 6MHz$)
 $V_{IN} = 5.0V$
 $I_{OUT} = 1mA \leftrightarrow 300mA$ ($t_r, t_f = 5\mu s$)
 $L = 0.47\mu H$ (MIPSCZ1005DR47T)
 $C_{IN} = 4.7\mu F$ (GRM035R60J475ME15)
 $C_L = 4.7\mu F$ (C1005X5R0J475M050BC)

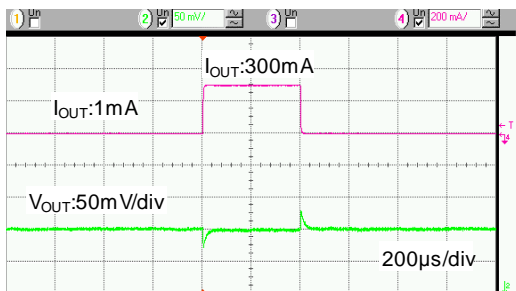

XC9282B18E ($V_{OUT} = 1.8V, f_{OSC} = 6MHz$)
 $V_{IN} = 5.0V$
 $I_{OUT} = 1mA \leftrightarrow 300mA$ ($t_r, t_f = 5\mu s$)
 $L = 0.47\mu H$ (MIPSCZ1005DR47T)
 $C_{IN} = 4.7\mu F$ (GRM035R60J475ME15)
 $C_L = 4.7\mu F$ (C1005X5R0J475M050BC)

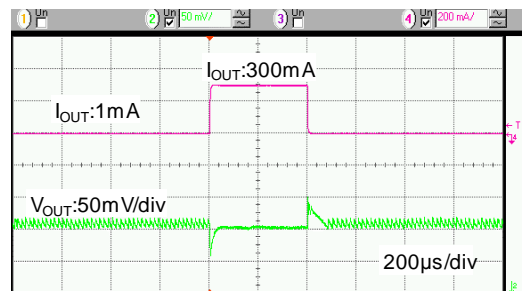

XC9281B33E ($V_{OUT} = 3.3V, f_{OSC} = 6MHz$)
 $V_{IN} = 5.0V$
 $I_{OUT} = 1mA \leftrightarrow 300mA$ ($t_r, t_f = 5\mu s$)
 $L = 0.47\mu H$ (MIPSCZ1005DR47T)
 $C_{IN} = 4.7\mu F$ (GRM035R60J475ME15)
 $C_L = 4.7\mu F$ (C1005X5R0J475M050BC)

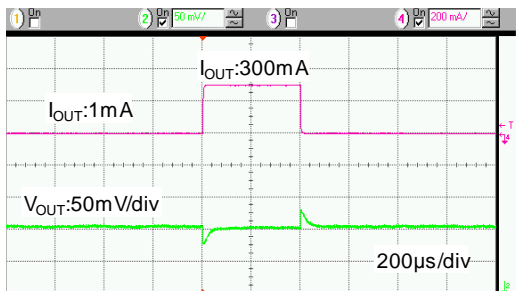

XC9282B33E ($V_{OUT} = 3.3V, f_{OSC} = 6MHz$)
 $V_{IN} = 5.0V$
 $I_{OUT} = 1mA \leftrightarrow 300mA$ ($t_r, t_f = 5\mu s$)
 $L = 0.47\mu H$ (MIPSCZ1005DR47T)
 $C_{IN} = 4.7\mu F$ (GRM035R60J475ME15)
 $C_L = 4.7\mu F$ (C1005X5R0J475M050BC)

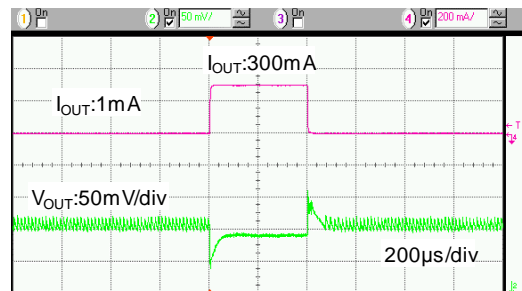

TYPICAL PERFORMANCE CHARACTERISTICS (Continued)

(18) Load Transient Responses(Continued)

XC9281B10D ($V_{OUT} = 1.0V, f_{OSC} = 4MHz$)
 $V_{IN} = 5.0V$
 $I_{OUT} = 1mA \leftrightarrow 300mA$ ($t_r, t_f = 5\mu s$)
 $L = 1.0\mu H$ (MCEE1005T1R0MHN)
 $C_{IN} = 4.7\mu F$ (GRM035R60J475ME15)
 $C_L = 4.7\mu F$ (C1005X5R0J475M050BC)

XC9282B10D ($V_{OUT} = 1.0V, f_{OSC} = 4MHz$)
 $V_{IN} = 5.0V$
 $I_{OUT} = 1mA \leftrightarrow 300mA$ ($t_r, t_f = 5\mu s$)
 $L = 1.0\mu H$ (MCEE1005T1R0MHN)
 $C_{IN} = 4.7\mu F$ (GRM035R60J475ME15)
 $C_L = 4.7\mu F$ (C1005X5R0J475M050BC)

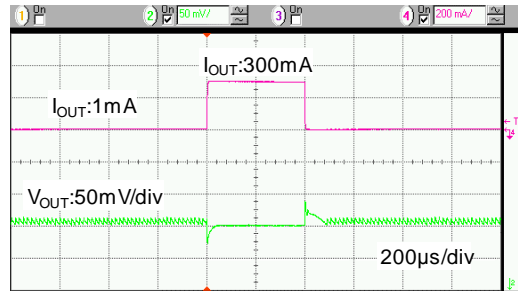
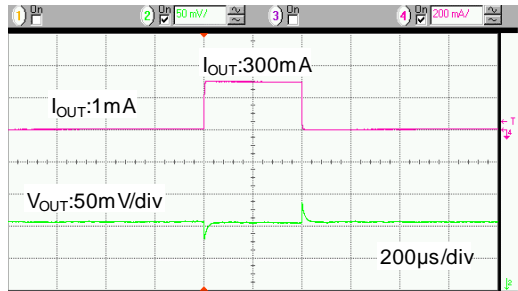

XC9281B18D ($V_{OUT} = 1.8V, f_{OSC} = 4MHz$)
 $V_{IN} = 5.0V$
 $I_{OUT} = 1mA \leftrightarrow 300mA$ ($t_r, t_f = 5\mu s$)
 $L = 1.0\mu H$ (MCEE1005T1R0MHN)
 $C_{IN} = 4.7\mu F$ (GRM035R60J475ME15)
 $C_L = 4.7\mu F$ (C1005X5R0J475M050BC)

XC9282B18D ($V_{OUT} = 1.8V, f_{OSC} = 4MHz$)
 $V_{IN} = 5.0V$
 $I_{OUT} = 1mA \leftrightarrow 300mA$ ($t_r, t_f = 5\mu s$)
 $L = 1.0\mu H$ (MCEE1005T1R0MHN)
 $C_{IN} = 4.7\mu F$ (GRM035R60J475ME15)
 $C_L = 4.7\mu F$ (C1005X5R0J475M050BC)

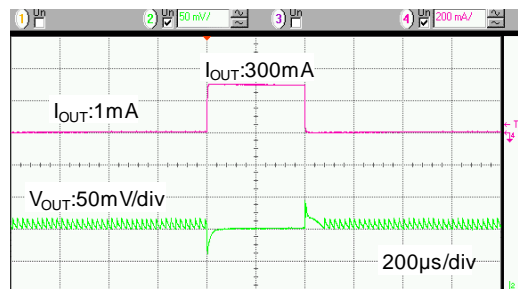
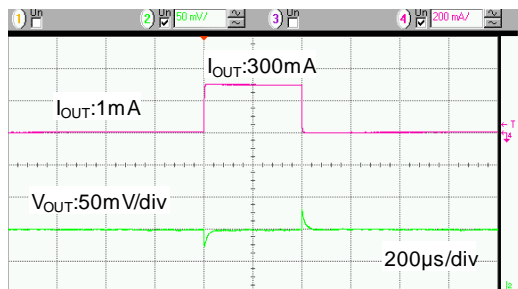

XC9281B33D ($V_{OUT} = 3.3V, f_{OSC} = 4MHz$)
 $V_{IN} = 5.0V$
 $I_{OUT} = 1mA \leftrightarrow 300mA$ ($t_r, t_f = 5\mu s$)
 $L = 1.0\mu H$ (MCEE1005T1R0MHN)
 $C_{IN} = 4.7\mu F$ (GRM035R60J475ME15)
 $C_L = 4.7\mu F$ (C1005X5R0J475M050BC)

XC9282B33D ($V_{OUT} = 3.3V, f_{OSC} = 4MHz$)
 $V_{IN} = 5.0V$
 $I_{OUT} = 1mA \leftrightarrow 300mA$ ($t_r, t_f = 5\mu s$)
 $L = 1.0\mu H$ (MCEE1005T1R0MHN)
 $C_{IN} = 4.7\mu F$ (GRM035R60J475ME15)
 $C_L = 4.7\mu F$ (C1005X5R0J475M050BC)

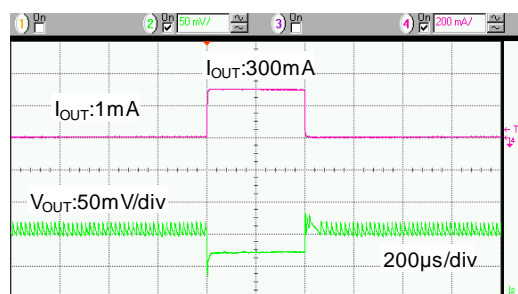
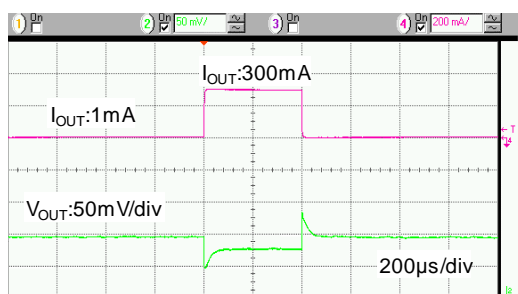

■ PACKAGING INFORMATION

For the latest package information go to, www.torexsemi.com/technical-support/packages

PACKAGE	OUTLIN / LAND PATTERN	THERMAL CHARACTERISTICS	
LGA-6B01	LGA-6B01 PKG	JESD51-7 Board	LGA-6B01 Power Dissipation
WLP-5-06	WLP-5-06 PKG	JESD51-7 Board	WLP-5-06 Power Dissipation

MARKING RULE

● LGA-6B01 / WLP-5-06

① represents products series

MARK	PRODUCT SERIESIES
8	XC9281*****-G
9	XC9282*****-G

② represents type, Oscillation Frequency, and the second decimal place of the output voltage

MARK	Oscillation Frequency	品名表記例
A	6.0MHz	XC928*A*0E**-G~XC928*A*9E**-G
B		XC928*B*0E**-G~XC928*B*9E**-G
C		XC928*A*AE**-G~XC928*A*ME**-G
D		XC928*B*AE**-G~XC928*B*ME**-G
E	4.0MHz	XC928*A*0D**-G~XC928*A*9D**-G
F		XC928*B*0D**-G~XC928*B*9D**-G
H		XC928*A*AD**-G~XC928*A*MD**-G
K		XC928*B*AD**-G~XC928*B*MD**-G

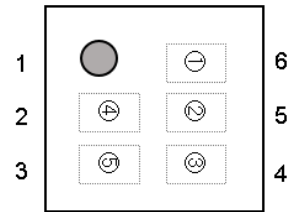

LGA-6B01

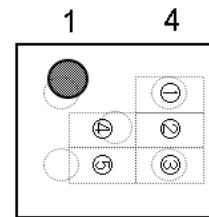

WLP-5-06

③ represents output voltage

MARK	OUTPUT VOLTAGE (V)		PRODUCT SERIESIES
0	0.7	0.75	XC928**07/0K***-G
1	0.8	0.85	XC928**08/0L***-G
2	0.9	0.95	XC928**09/0M***-G
3	1.0	1.05	XC928**10/1A***-G
4	1.1	1.15	XC928**11/1B***-G
5	1.2	1.25	XC928**12/1C***-G
6	1.3	1.35	XC928**13/1D***-G
7	1.4	1.45	XC928**14/1E***-G
8	1.5	1.55	XC928**15/1F***-G
9	1.6	1.65	XC928**16/1H***-G
A	1.7	1.75	XC928**17/1K***-G
B	1.8	1.85	XC928**18/1L***-G
C	1.9	1.95	XC928**19/1M***-G
D	2.0	2.05	XC928**20/2A***-G
E	2.1	2.15	XC928**21/2B***-G
F	2.2	2.25	XC928**22/2C***-G
H	2.3	2.35	XC928**23/2D***-G
K	2.4	2.45	XC928**24/2E***-G
L	2.5	2.55	XC928**25/2F***-G
M	2.6	2.65	XC928**26/2H***-G
N	2.7	2.75	XC928**27/2K***-G
P	2.8	2.85	XC928**28/2L***-G
R	2.9	2.95	XC928**29/2M***-G
S	3.0	3.05	XC928**30/3A***-G
T	3.1	3.15	XC928**31/3B***-G
U	3.2	3.25	XC928**32/3C***-G
V	3.3	3.35	XC928**33/3D***-G
X	3.4	3.45	XC928**34/3E***-G
Y	3.5	3.55	XC928**35/3F***-G
Z	3.6	-	XC928**36E**-G

④⑤ represents production lot number

01~09, 0A~0Z, 11~9Z, A1~A9, AA~AZ, B1~ZZ in order. (G, I, J, O, Q, W excluded)

* No character inversion used.

1. The product and product specifications contained herein are subject to change without notice to improve performance characteristics. Consult us, or our representatives before use, to confirm that the information in this datasheet is up to date.
2. The information in this datasheet is intended to illustrate the operation and characteristics of our products. We neither make warranties or representations with respect to the accuracy or completeness of the information contained in this datasheet nor grant any license to any intellectual property rights of ours or any third party concerning with the information in this datasheet.
3. Applicable export control laws and regulations should be complied and the procedures required by such laws and regulations should also be followed, when the product or any information contained in this datasheet is exported.
4. The product is neither intended nor warranted for use in equipment of systems which require extremely high levels of quality and/or reliability and/or a malfunction or failure which may cause loss of human life, bodily injury, serious property damage including but not limited to devices or equipment used in 1) nuclear facilities, 2) aerospace industry, 3) medical facilities, 4) automobile industry and other transportation industry and 5) safety devices and safety equipment to control combustions and explosions. Do not use the product for the above use unless agreed by us in writing in advance.
5. Although we make continuous efforts to improve the quality and reliability of our products; nevertheless Semiconductors are likely to fail with a certain probability. So in order to prevent personal injury and/or property damage resulting from such failure, customers are required to incorporate adequate safety measures in their designs, such as system fail safes, redundancy and fire prevention features.
6. Our products are not designed to be Radiation-resistant.
7. Please use the product listed in this datasheet within the specified ranges.
8. We assume no responsibility for damage or loss due to abnormal use.
9. All rights reserved. No part of this datasheet may be copied or reproduced unless agreed by Torex Semiconductor Ltd in writing in advance.

TOREX SEMICONDUCTOR LTD.

单击下面可查看定价，库存，交付和生命周期等信息

[>>Torex Semiconductor\(特瑞仕\)](#)