

XC6423 Series

Ultra Small 300mA Dual High Speed LDO Regulator with Inrush Current Prevention

GENERAL DESCRIPTION

The XC6423 series is an ultra small CMOS dual LDO regulator, with 300mA output current capability. The series features high accuracy of 1% output voltages, high ripple rejection and low dropout voltage.

The series is available in LGA-6A01 (1.2mm × 1.2mm × h0.4mm) which features ultra small and high heat dissipation. The series is suited for high density board installation.

Each regulator can be turned off independently to be in stand-by mode by controlling EN pin. In this state, the electric charge at the output capacitor (C_L) is discharged via the internal auto-discharge switch, and as a result the V_{OUT} voltage quickly returns to the V_{SS} level.

The output stabilization capacitor (C_L) is also compatible with low ESR ceramic capacitors.

The high level of output stability is maintained even during frequent load fluctuations, due to the excellent transient response performance.

Over current protection circuit and over heat protection circuit are integrated, these circuits start working when output current reaches current limit or junction temperature reaches temperature limit.

The two regulators are completely isolated so that a cross talk during load fluctuations is minimized.

APPLICATIONS

- Smart phones / Mobile phones
- Wireless LAN
- Mobile devices / terminals
- Modules (wireless, cameras, etc.)

FEATURES

Output Current	: 300mA
Input Voltage Range	: 1.6V~5.5V
Output Voltage Range	: 1.2V~3.6V 0.05V increments
High Accuracy	: ±1% (V _{OUT} ≥ 2.00V) ±20mV (V _{OUT} ≤ 1.95V)
Dropout Voltage	: 95mV@I _{OUT} =150mA (V _{OUT} =3.0V)
Low Power Consumption	: 90 μA / ch (TYP.)
Stand-by Current	: Less than 0.1 μA
Ripple Rejection	: 75dB@1kHz
EN Pin Function	: Active High C _L Auto Discharge
Protection Circuit	: Current Limit 450mA (TYP.) Short-circuit Current 125mA (TYP.) Inrush Current Prevention Thermal Shutdown
Low ESR Capacitor	: Ceramic Capacitor Compatible 1 μF
Operating Ambient Temperature	: -40°C~+85°C
Package	: LGA-6A01
Environmentally Friendly	: EU RoHS Compliant, Pb Free

TYPICAL APPLICATION CIRCUITS

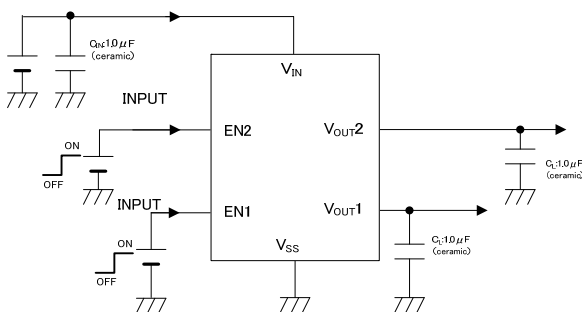

TYPICAL PERFORMANCE CHARACTERISTICS

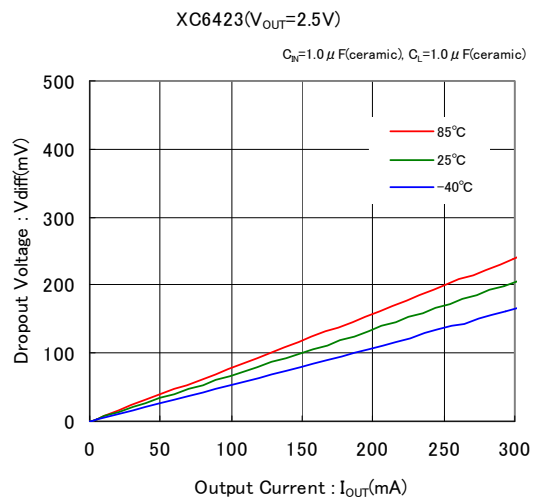

■ BLOCK DIAGRAM

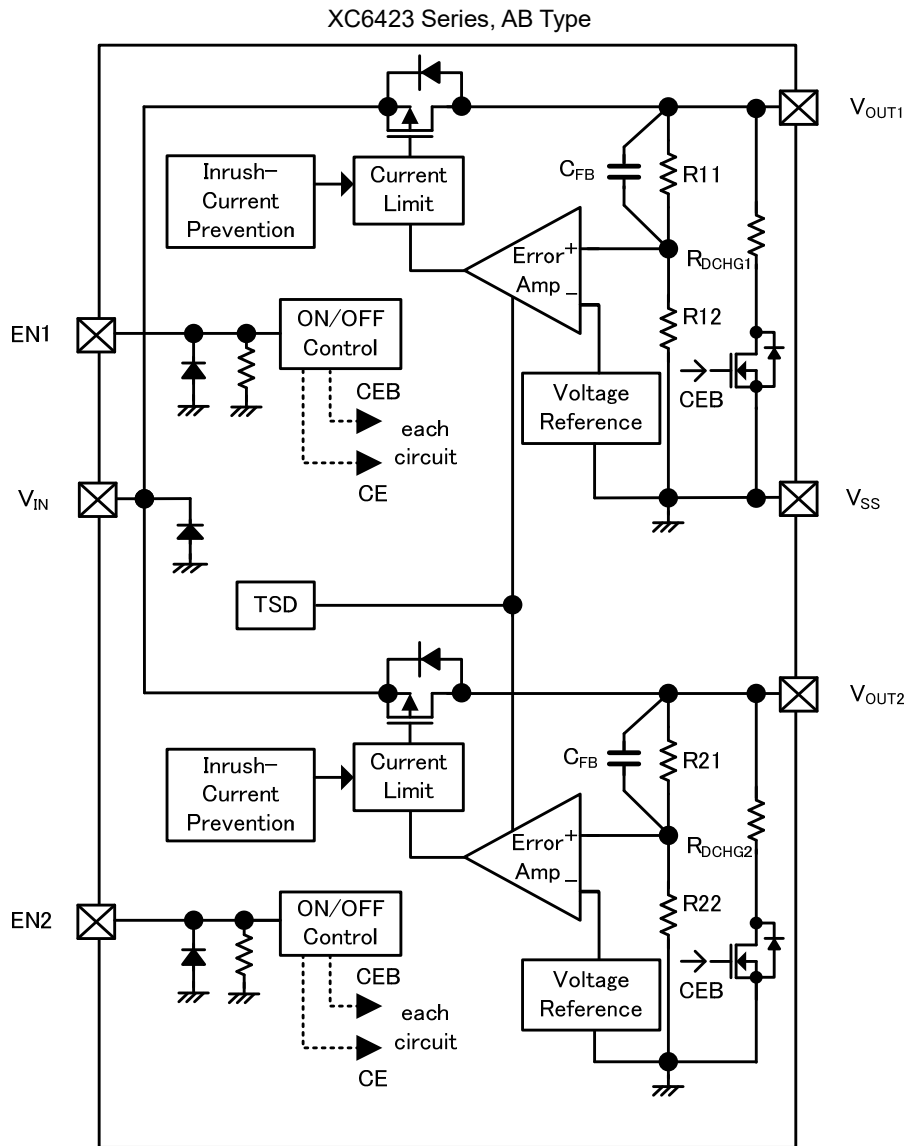

* Diodes inside the circuits are ESD protection diodes and parasitic diodes.

■ PRODUCT CLASSIFICATION

● Ordering Information

XC6423①②③④⑤⑥⑦

DESIGNATOR	ITEM	SYMBOL	DESCRIPTION
①②	Type	AB	Includes EN Pull-down, C _L Auto-discharge, Thermal Shutdown and Inrush Current Prevention
③④	Output Voltage	01~	See the chart below
⑤⑥⑦ (*)	Package (Order Unit)	1R-G	LGA-6A01 (5,000/Reel)

(*) The "G" suffix denotes Halogen and Antimony free as well as being fully EU RoHS compliant.

Standard Voltage

③④	VR1 (V)	VR2 (V)	PRODUCT NUMBER
32	1.8	2.8	XC6423AB321R-G

Output Voltage Options

DESIGNATOR ③④

③④	VR1 (V)	VR2 (V)	③④	VR1 (V)	VR2 (V)
01	1.20	1.20	34	2.80	3.00
02	1.20	1.50	35	2.80	3.30
03	1.20	2.50	36	1.20	3.60
04	1.20	2.85	37	3.60	1.20
05	1.20	3.00	38	1.20	2.80
06	1.20	3.30	39	3.30	2.00
07	1.50	1.50	40	3.00	3.30
08	1.50	1.80	41	3.30	3.30
09	1.50	2.50	42	1.30	1.50
10	1.50	2.85	43	2.60	2.80
11	1.50	3.00	44	3.10	3.30
12	1.50	3.30	45	1.50	2.60
13	1.80	1.80	46	2.60	3.30
14	1.80	2.50	47	3.40	3.40
15	2.85	2.85	48	2.85	2.60
16	1.80	2.85	49	3.30	1.80
17	1.80	3.00	50	1.80	1.20
18	3.00	1.80	51	3.10	3.10
19	1.80	3.30	52	1.50	3.10
20	2.50	2.50	53	3.30	2.80
21	2.50	2.80	54	3.00	2.80
22	2.50	2.85	55	3.30	3.00
23	3.30	1.50	56	3.60	3.60
24	2.50	3.00	57	3.30	3.10
25	2.50	3.30	58	3.10	3.00
26	2.85	3.00	59	3.10	2.90
27	2.85	3.30	60	3.10	2.50
28	3.00	3.00	61	3.00	2.90
29	1.20	1.80	62	3.00	2.50
30	1.30	2.80	63	1.80	1.90
31	1.50	2.80	64	1.80	1.85
32	1.80	2.80	65	1.70	1.70
33	2.80	2.80			

For other output voltage combinations, please contact your local Torex sales office or representative.

PIN CONFIGURATION

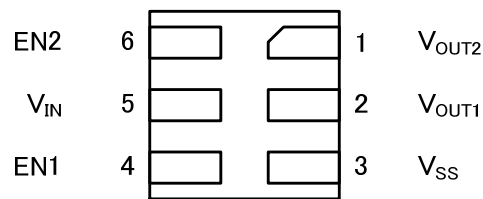

LGA-6A01
(BOTTOM VIEW)

PIN ASSIGNMENT

PIN NUMBER	PIN NAME	FUNCTIONS
LGA-6A01		
1	V _{OUT2}	Output 2
2	V _{OUT1}	Output 1
3	V _{SS}	Ground
4	EN1	ON/OFF Control 1
5	V _{IN}	Power Supply Input
6	EN2	ON/OFF Control 2

FUNCTION CHART

XC6423 Series, AB Type

PIN NAME	SIGNAL	STATUS
EN	L	Stand-by
	H	Active
	OPEN	Stand-by*

H=High Level , L=Low Level

* When the EN pin is left open, an internal pull-down resistor maintains the EN pin voltage to be low.

ABSOLUTE MAXIMUM RATINGS

PARAMETER	SYMBOL	RATINGS	UNITS
Input Voltage	V _{IN}	-0.3~+7.0	V
Output Current	I _{OUT1} +I _{OUT2}	1100 ^(*1)	mA
Output Voltage1 Output Voltage2	V _{OUT1} , V _{OUT2}	-0.3~V _{IN} +0.3 or +7.0 ^(*2)	V
EN Input Voltage1 EN Input Voltage2	V _{EN1} , V _{EN2}	-0.3~+7.0	V
Power Dissipation	LGA-6A01 Pd	650 (PCB mounted) ^(*3)	mW
Operating Ambient Temperature	Topr	-40~+85	°C
Storage Temperature	Tstg	-55~+125	°C

All voltages are described based on the V_{SS}.

^(*1) Please use within the range of Pd > {(V_{IN}-V_{OUT1})×I_{OUT1} + (V_{IN}-V_{OUT2})×I_{OUT2}}

^(*2) The maximum rating corresponds to the lowest value between V_{IN}+0.3 or +7.0.

^(*3) This is a reference data taken by using the test board.

■ ELECTRICAL CHARACTERISTICS

● XC6423 Series

Regulator1, Regulator2 ⁽⁶⁾

Ta=25°C

PARAMETER	SYMBOL	CONDITIONS	MIN.	TYP.	MAX.	UNITS	CIRCUIT
Output Voltage	V _{OUT(E)} ⁽¹⁾	V _{OUT} ≥ 2.0V, I _{OUT} = 10mA	V _{OUT(T)} × 0.99 ⁽²⁾	V _{OUT(T)} ⁽²⁾	V _{OUT(T)} × 1.01 ⁽²⁾	V	①
			"E-0" ⁽³⁾				
		V _{OUT} < 2.0V, I _{OUT} = 10mA	V _{OUT(T)} - 0.02 ⁽²⁾	V _{OUT(T)} ⁽²⁾	V _{OUT(T)} + 0.02 ⁽²⁾		
			"E-0" ⁽³⁾				
Maximum Output Current	I _{OUTMAX}	-	300	-	-	mA	①
Load Regulation	ΔV _{OUT}	0.1mA ≤ I _{OUT} ≤ 300mA	-	17	37	mV	①
Dropout Voltage	V _{dif} ⁽⁴⁾	I _{OUT} = 300mA	-	"E-1" ⁽⁵⁾		mV	①
Supply Current	I _{DD}	I _{OUT} = 0mA	-	90	190	μA	②
Stand-by Current	I _{STB}	V _{EN} = V _{SS}	-	0.01	0.10	μA	②
Line Regulation	ΔV _{OUT} / (ΔV _{IN} · V _{OUT})	V _{OUT(T)} ≤ 2.0V, I _{OUT} = 30mA 2.5V ≤ V _{IN} ≤ 5.5V	-	0.02	0.10	% / V	①
		V _{OUT(T)} ≥ 2.05V, I _{OUT} = 30mA V _{OUT(T)} + 0.5V ≤ V _{IN} ≤ 5.5V					
Input Voltage	V _{IN}	-	1.6	-	5.5	V	①
Output Voltage Temperature Characteristics (R&D Value)	ΔV _{OUT} / (ΔT _{opr} · V _{OUT})	I _{OUT} = 10mA, -40°C ≤ T _{opr} ≤ 85°C	-	±100	-	ppm / °C	①
Power Supply Rejection Ratio	PSRR	V _{IN} = {V _{OUT(T)} + 1.0} + 0.5V _{p-pAC} V _{EN} = V _{OUT(T)} + 1.0V I _{OUT} = 30mA, f = 1kHz	-	75	-	dB	③
Current Limit	I _{LIM}	-	310	450	-	mA	①
Short-circuit Current	I _{SHORT}	V _{OUT} = V _{SS}	-	125	-	mA	①
EN "H" Level Voltage	V _{ENH}	-	0.9	-	5.5	V	①
EN "L" Level Voltage	V _{ENL}	-	V _{SS}	-	0.3	V	①
EN "H" Level Current	I _{ENH}	V _{EN} = V _{IN} = 5.5V	2.9	6.0	9.5	μA	①
EN "L" Level Current	I _{ENL}	V _{EN} = V _{SS}	-0.1	-	0.1	μA	①
C _L Auto-discharge Resistance	R _{DCHG}	V _{IN} = 5.5V, V _{EN} = V _{SS} , V _{OUT} = 2.0V	-	230	-	Ω	①
Inrush Current	I _{RUSH}	V _{IN} = 5.5V, V _{CE} = 0 → 5.5V	-	150	-	mA	②
Thermal Shutdown Detect Temperature	T _{TSD}	Junction Temperature	-	150	-	°C	①
Thermal Shutdown Release Temperature	T _{TSR}	Junction Temperature	-	125	-	°C	①
Thermal Shutdown Hysteresis Width	T _{TSD} - T _{TSR}	Junction Temperature	-	25	-	°C	①

NOTE:

Unless otherwise stated, V_{IN} = V_{OUT(T)} + 1.0V, V_{EN} = V_{IN}

⁽¹⁾ V_{OUT(E)} is Effective output voltage

⁽²⁾ V_{OUT(T)} is Nominal output voltage

⁽³⁾ E-0: OUTPUT VOLTAGE (Refer to the Voltage Chart)

⁽⁴⁾ V_{dif} = {V_{IN1} - V_{OUT1}}

V_{IN1} is the input voltage when V_{OUT1} appears at the V_{OUT} pin while input voltage is gradually decreased.

V_{OUT1} is the voltage equal to 98% of the normal output voltage when amply stabilized V_{OUT(T)} + 1.0V is input at the V_{IN} pin.

⁽⁵⁾ E-1: DROPOUT VOLTAGE (Refer to the Voltage Chart)

⁽⁶⁾ E-1: When each channel is measured, the other channel is turned off (V_{EN} = V_{SS})

ELECTRICAL CHARACTERISTICS (Continued)

Regulator 1, Regulator 2

Voltage Chart

Ta=25°C

NOMINAL OUTPUT VOLTAGE (V)	E-0		E-1		NOMINAL OUTPUT VOLTAGE (V)	E-0		E-1	
	OUTPUT VOLTAGE (V)		DROPOUT VOLTAGE (mV)			OUTPUT VOLTAGE (V)		DROPOUT VOLTAGE (mV)	
	V _{OUT(E)}		V _{dif}			V _{OUT(E)}		V _{dif}	
V _{OUT(T)}	MIN.	MAX.	TYP.	MAX.	V _{OUT(T)}	MIN.	MAX.	TYP.	MAX.
1.20	1.1800	1.2200	550	650	2.50	2.4750	2.5250	220	270
1.25	1.2300	1.2700			2.55	2.5245	2.5755		
1.30	1.2800	1.3200	480	575	2.60	2.5740	2.6260		
1.35	1.3300	1.3700			2.65	2.6235	2.6765		
1.40	1.3800	1.4200	430	520	2.70	2.6730	2.7270		
1.45	1.4300	1.4700			2.75	2.7225	2.7775		
1.50	1.4800	1.5200			2.80	2.7720	2.8280		
1.55	1.5300	1.5700			2.85	2.8215	2.8785		
1.60	1.5800	1.6200	350	420	2.90	2.8710	2.9290		
1.65	1.6300	1.6700			2.95	2.9205	2.9795		
1.70	1.6800	1.7200			3.00	2.9700	3.0300		
1.75	1.7300	1.7700			3.05	3.0195	3.0805		
1.80	1.7800	1.8200	300	360	3.10	3.0690	3.1310		
1.85	1.8300	1.8700			3.15	3.1185	3.1815		
1.90	1.8800	1.9200			3.20	3.1680	3.2320		
1.95	1.9300	1.9700			3.25	3.2175	3.2825		
2.00	1.9800	2.0200	270	325	3.30	3.2670	3.3330	190	240
2.05	2.0295	2.0705			3.35	3.3165	3.3835		
2.10	2.0790	2.1210			3.40	3.3660	3.4340		
2.15	2.1285	2.1715			3.45	3.4155	3.4845		
2.20	2.1780	2.2220			3.50	3.4650	3.5350		
2.25	2.2275	2.2725			3.55	3.5145	3.5855		
2.30	2.2770	2.3230			3.60	3.5640	3.6360		
2.35	2.3265	2.3735							
2.40	2.3760	2.4240							
2.45	2.4255	2.4745							

TEST CIRCUITS

$C_{IN}=1.0\ \mu\text{F}$, $C_L=1.0\ \mu\text{F}$

Circuit ①

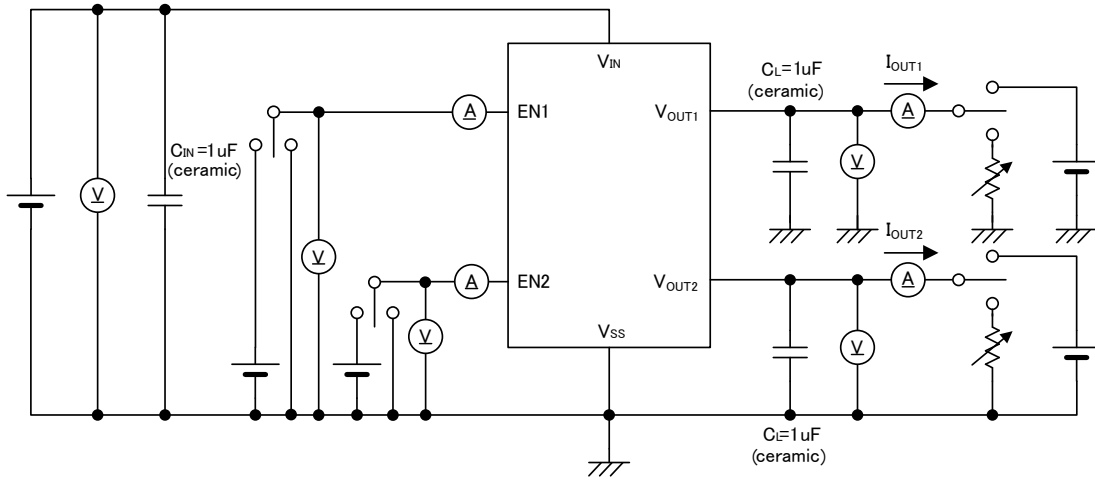

Circuit ②

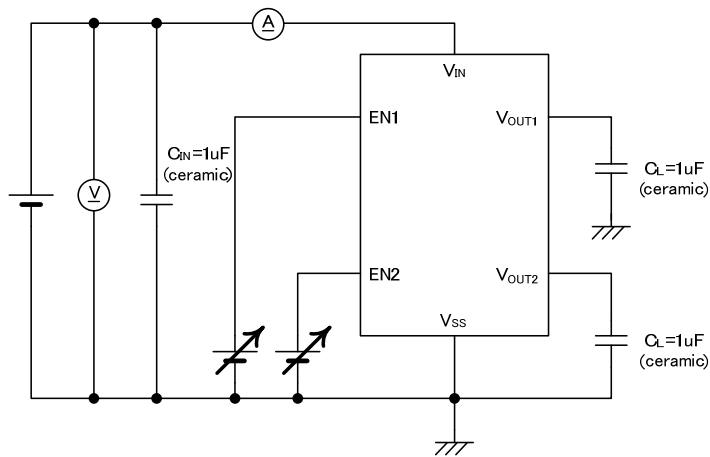

Circuit ③

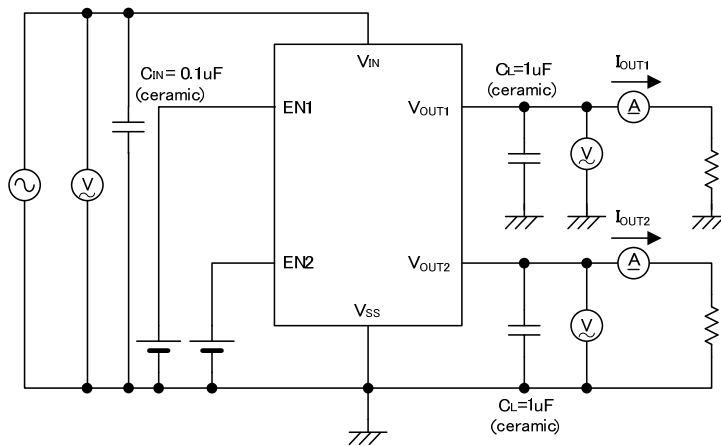

OPERATIONAL EXPLANATION

The voltage divided by resistors Rx1 & Rx2 is compared with the internal reference voltage by the error amplifier. The P-ch MOSFET which is connected to the Output pin (V_{OUT}) is then driven by the subsequent control signal. The output voltage at the Output pin (V_{OUT}) is controlled and stabilized by a system of negative feedback. The current limit circuit, short circuit protection and thermal protection operate in relation to the level of output voltage, output current and heat dissipation.

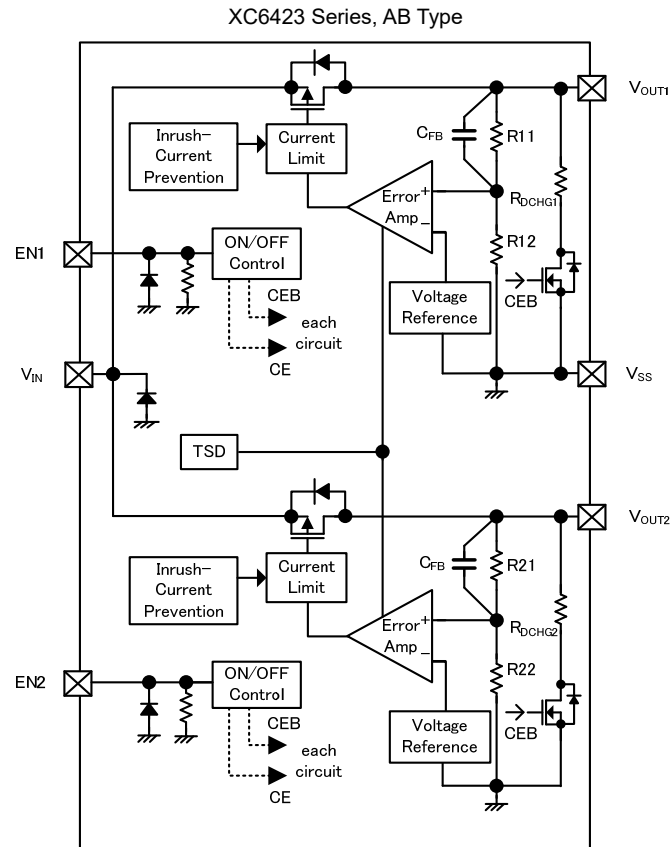

<Low ESR Capacitor>

The XC6423 series needs an output capacitor (C_L) for phase compensation. In order to ensure the stable phase compensation, please place an output capacitor (C_L) of $1.0 \mu F$ or bigger at the V_{OUT} pin and V_{SS} pin as close as possible. For a stable power input, please connect an input capacitor (C_{IN}) of $1.0 \mu F$ between V_{IN} pin and V_{SS} pin.

<Current Limiter, Short-Circuit Protection>

The XC6423 series has current limiter and droop shape of fold-back circuit. When the load current reaches the current limit, the droop current limiter circuit operates and the output voltage drops with keeping the load current. After that, the output voltage drops to a certain level, the fold-back circuit operates and the output current goes to decrease with a degree of output voltage decreasing. The output current finally falls at the level of 125mA when the output pin is short-circuited.

<EN Pin>

The IC's internal circuitry can be shutdown via the signal from the EN pin. The XC6423 series has a pull-down resistor at the EN pin inside. Even the EN pin is left open, the EN pin is fixed as Low level. However, inflow current is generated into the EN pin.

■ OPERATIONAL EXPLANATION (Continued)

<C_L Auto-Discharge Function>

The N-ch transistor located between the V_{OUT} pin and the V_{SS} pin and the C_L discharge resistance is set to 270Ω (TYP.) when V_{IN} is 5.5V (TYP.) and V_{OUT} is 2.0V (TYP.).

This N-ch transistor can quickly discharge the electric charge at the output capacitor (C_L), when a low signal is inputted to the EN pin. Moreover, discharge time of the output capacitor (C_L) is set by the C_L auto-discharge resistance (R_{DCHG}) and the output capacitance (C_L).

By setting time constant of a C_L auto-discharge resistance (R_{DCHG}) and an output capacitance (C_L) as $\tau = C_L \times R_{DCHG}$, the output voltage after discharge via the N-ch transistor is calculated by the following formula.

$$V = V_{OUT(E)} \times e^{-t/\tau}$$

V: Output voltage after discharge

V_{OUT(E)}: Output voltage

t: Discharge time

$\tau = R_{DCHG} \times C_L$

C_L: Output capacitance

R_{DCHG}: C_L auto-discharge resistance

or discharge time is calculated by the next formula.

$$t = \tau \ln (V_{OUT(E)} / V)$$

<Thermal Shutdown>

When the junction temperature of the built-in driver transistor reaches the temperature limit, the thermal shutdown circuit operates and the driver transistor will be set to OFF. The IC resumes its operation when the thermal shutdown function is released and the IC's operation is automatically restored because the junction temperature drops to the level of the thermal shutdown release voltage.

<Inrush Current Prevention>

The inrush current prevention circuit is built in the XC6423 series.

When the IC starts to operate, the prevention circuit limits the inrush current as less than 150mA (TYP.) from input pin (V_{IN}) to output pin (V_{OUT}) for charging output capacitor (C_L).

■ NOTES ON USE

1. For temporary, transitional voltage drop or voltage rising phenomenon, the IC is liable to malfunction should the ratings be exceeded.
2. Where wiring impedance is high, operations may become unstable due to the noise and/or phase lag depending on output current.
Please strengthen V_{IN} and V_{SS} wiring in particular.
3. Please wire the input capacitor (C_{IN}) and the output capacitor (C_L) as close to the IC as possible.
4. Torex places an importance on improving our products and its reliability.
We request that users incorporate fail-safe designs and post-aging prevention treatment when using Torex products in their systems.

TYPICAL PERFORMANCE CHARACTERISTICS

(1) Output Voltage vs. Output Current

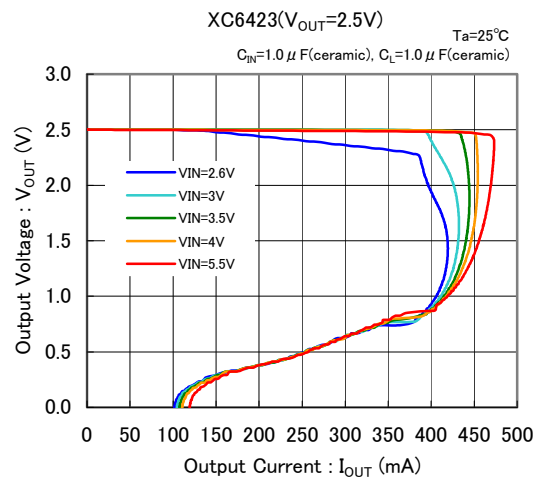
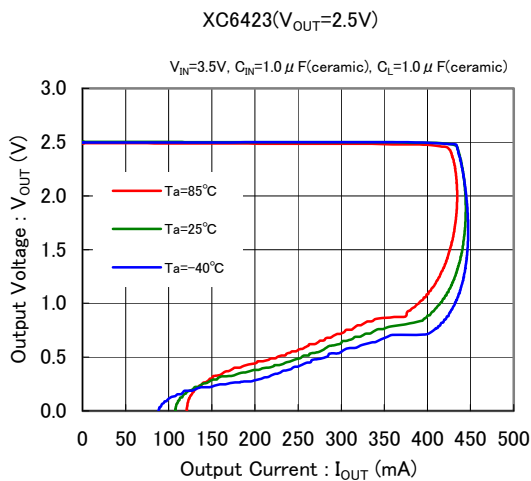
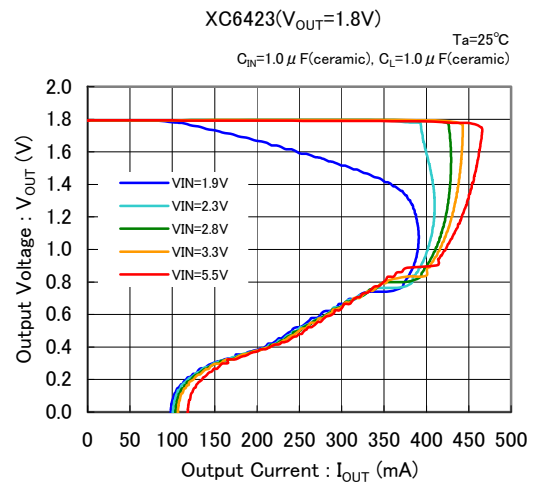
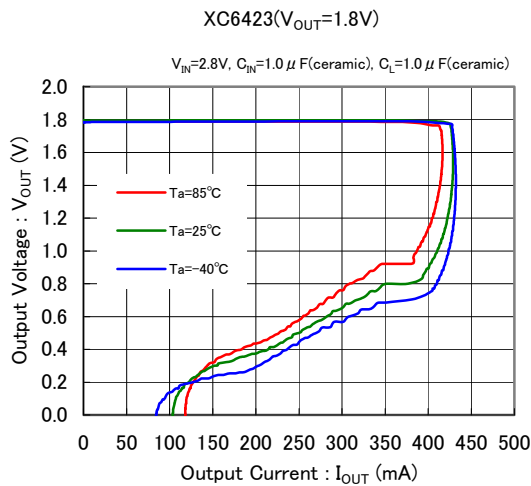
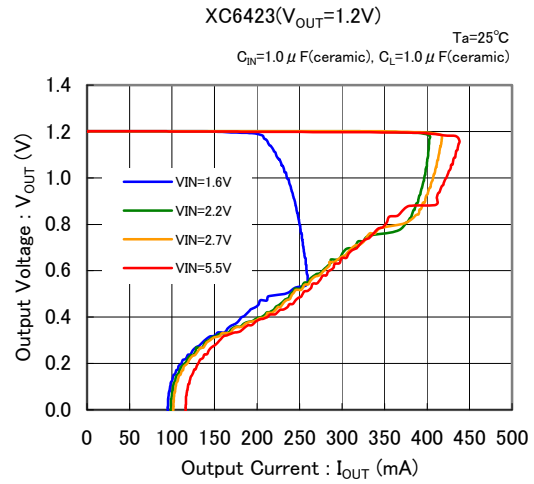
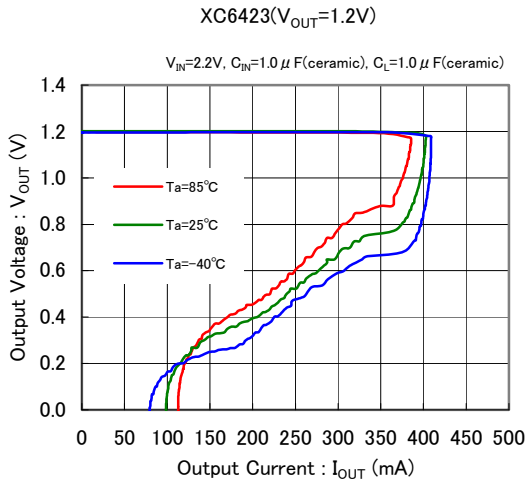

TYPICAL PERFORMANCE CHARACTERISTICS (Continued)

(1) Output Voltage vs. Output Current (Continued)

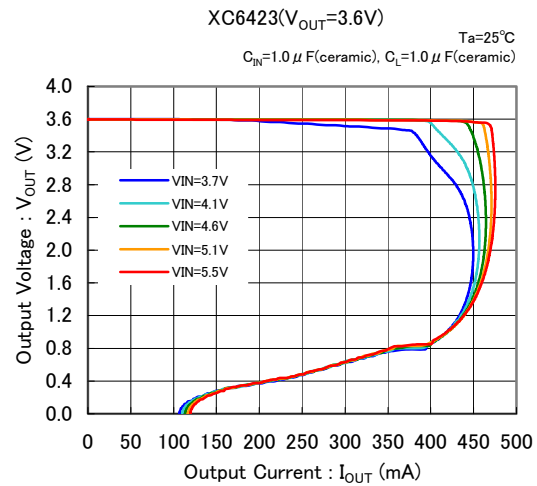
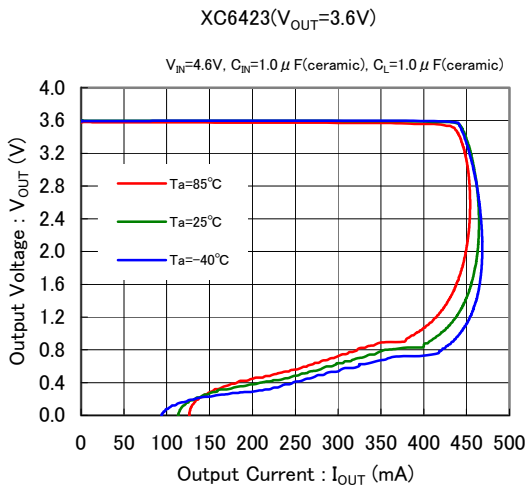

(2) Output Voltage vs. Input Voltage

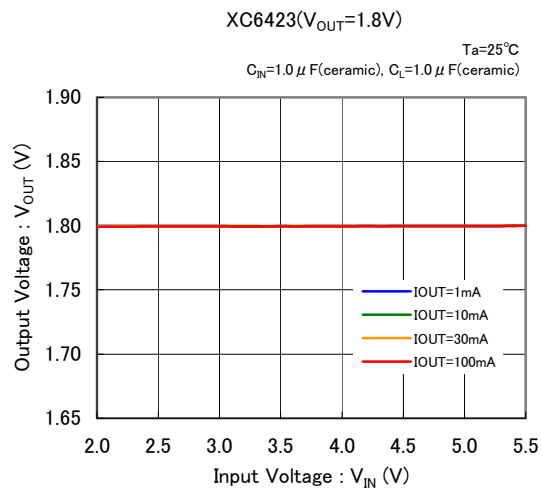
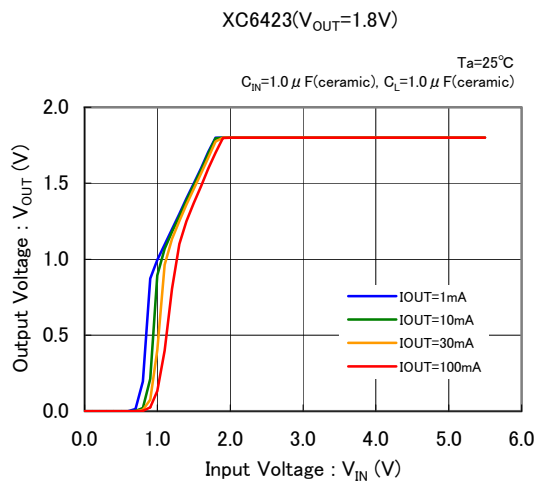
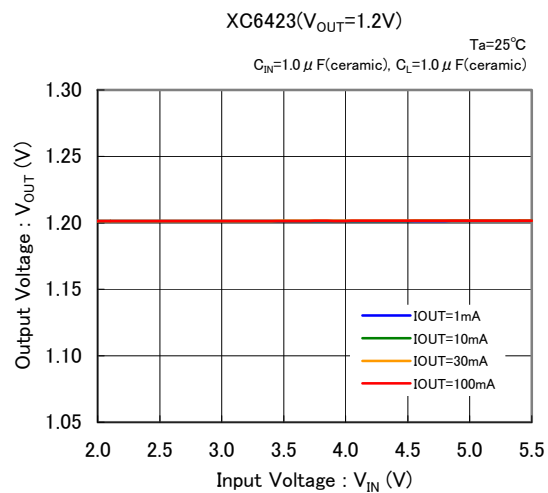
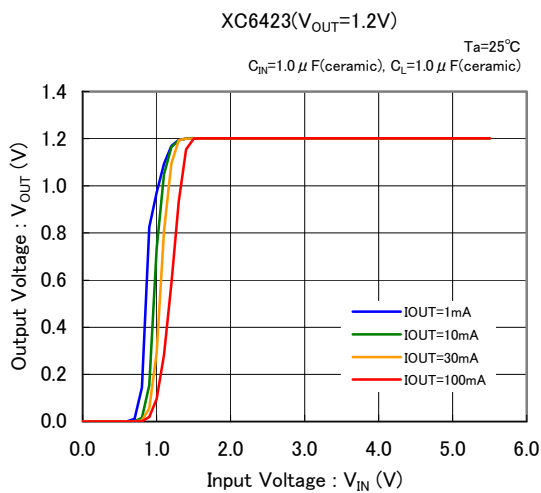

TYPICAL PERFORMANCE CHARACTERISTICS (Continued)

(2) Output Voltage vs. Input Voltage (Continued)

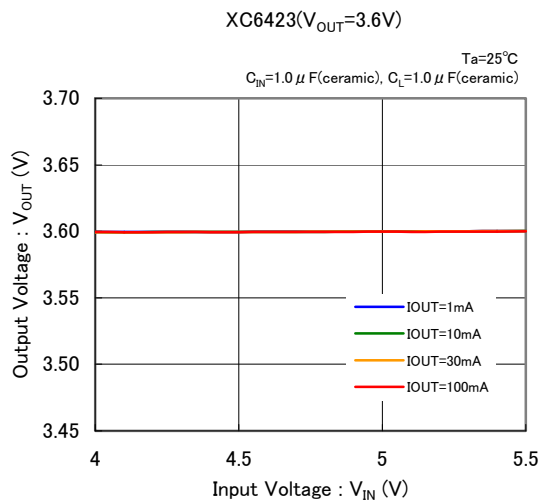
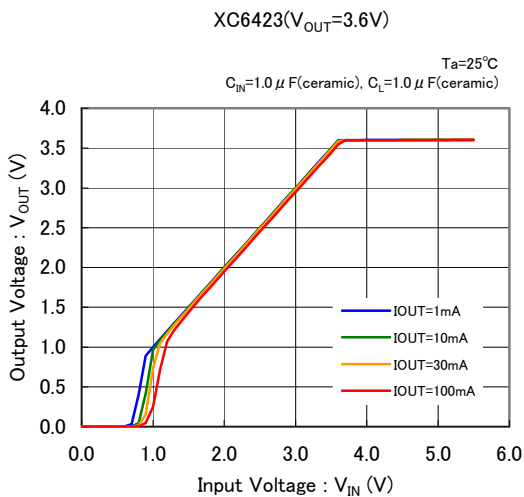
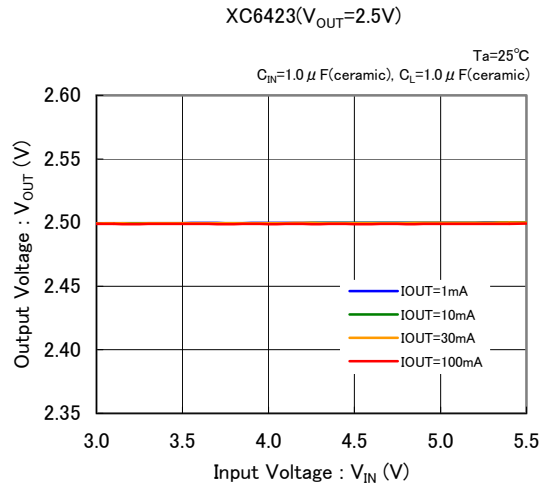
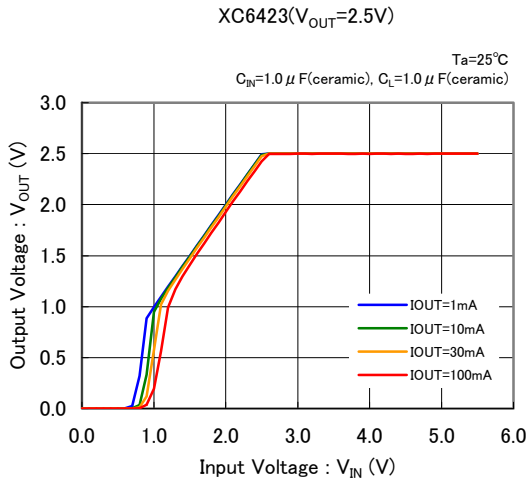

(3) Dropout Voltage vs. Output Current

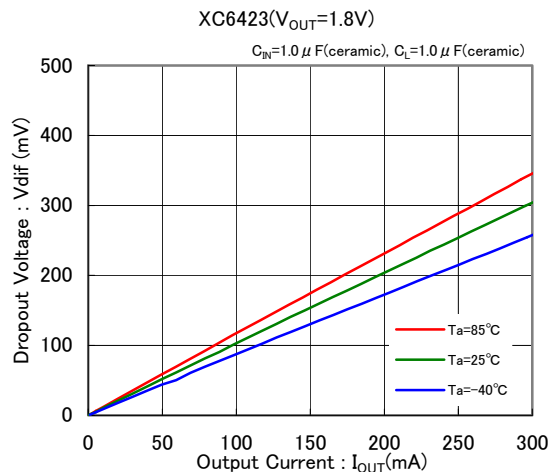
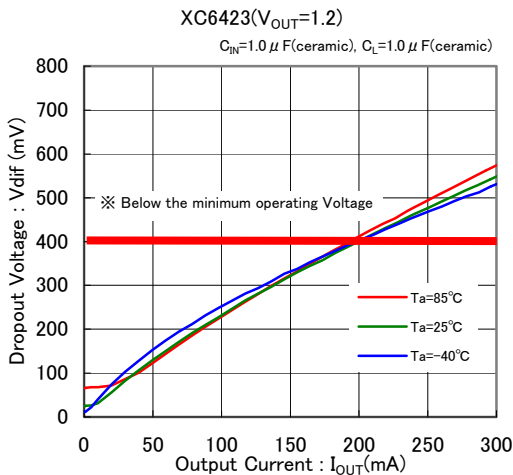

TYPICAL PERFORMANCE CHARACTERISTICS (Continued)

(3) Dropout Voltage vs. Output Current (Continued)

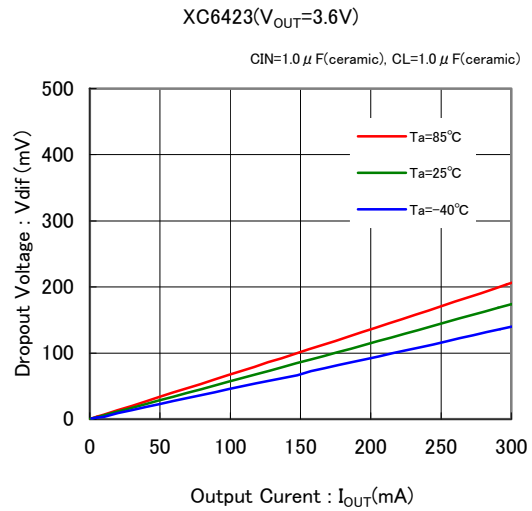
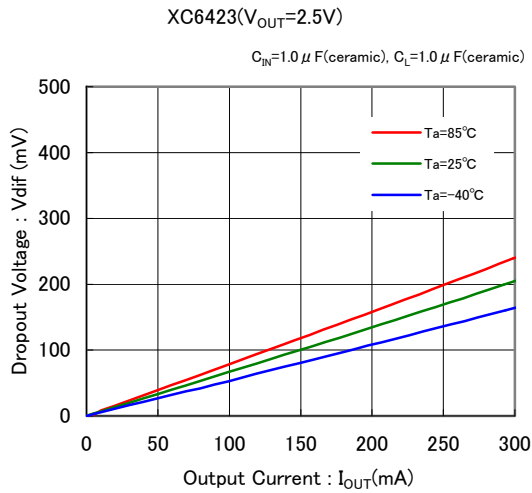

(4) Supply Current vs. Input Voltage

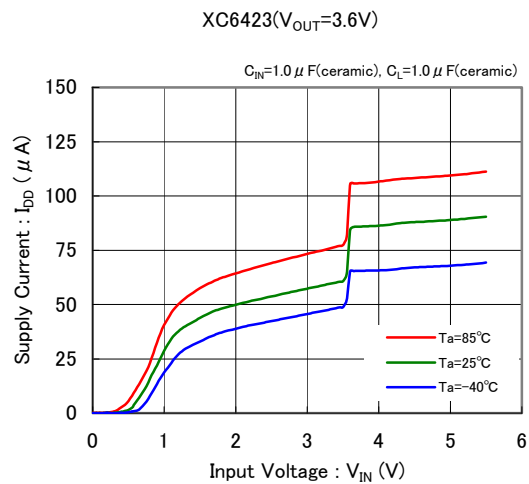
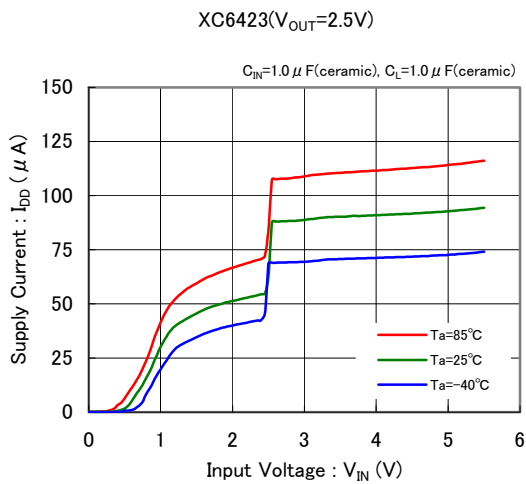
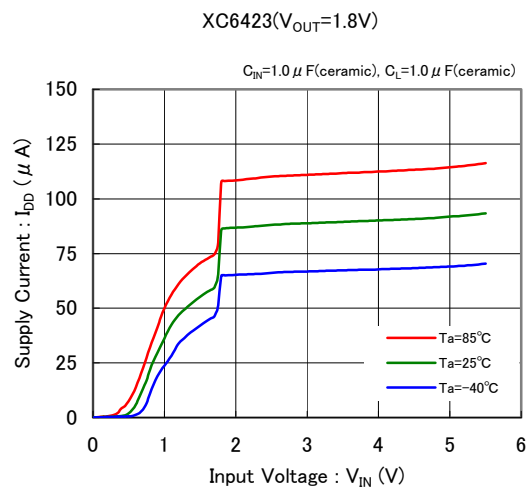
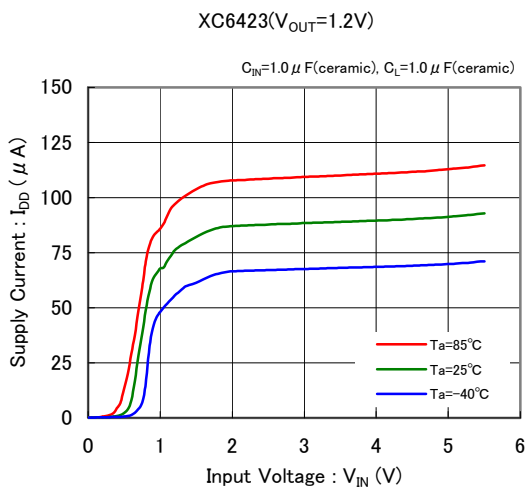

■ TYPICAL PERFORMANCE CHARACTERISTICS (Continued)

(5) Output Voltage vs. Ambient Temperature

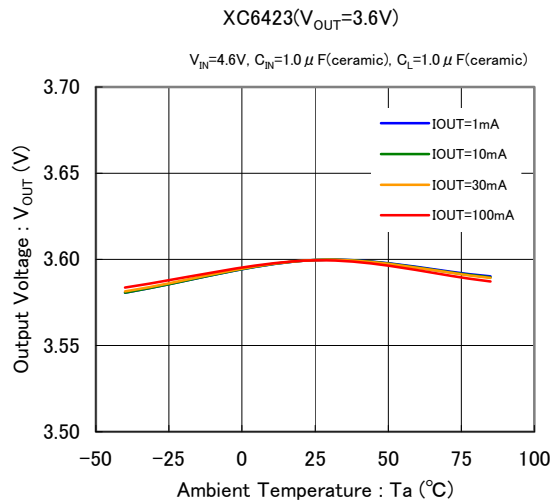
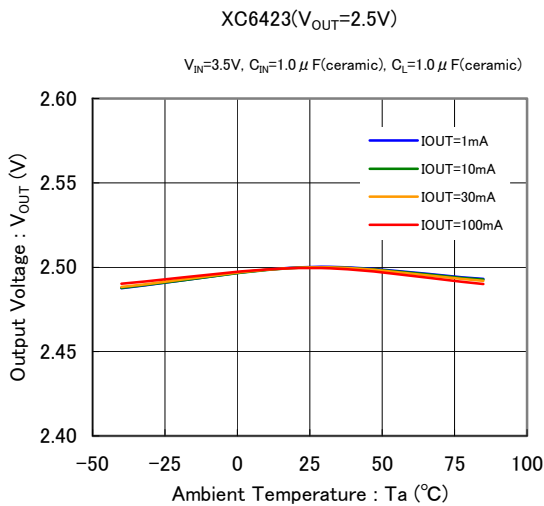
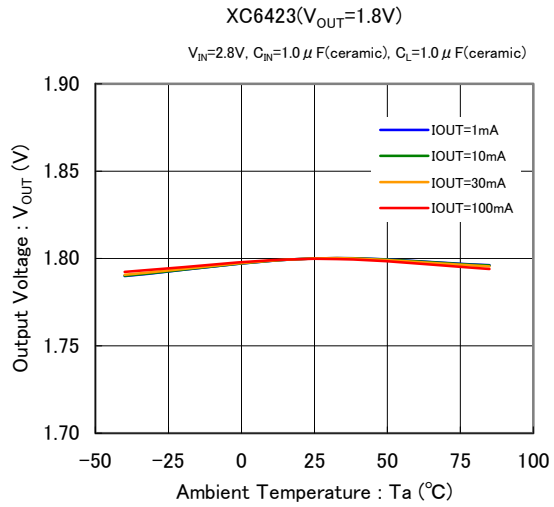
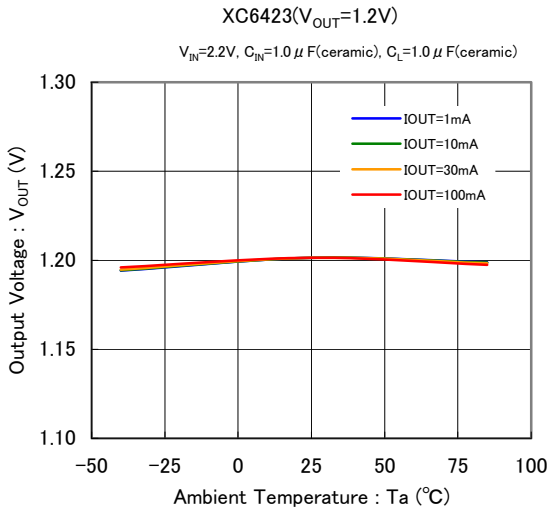

(6) Supply Current vs. Ambient Temperature

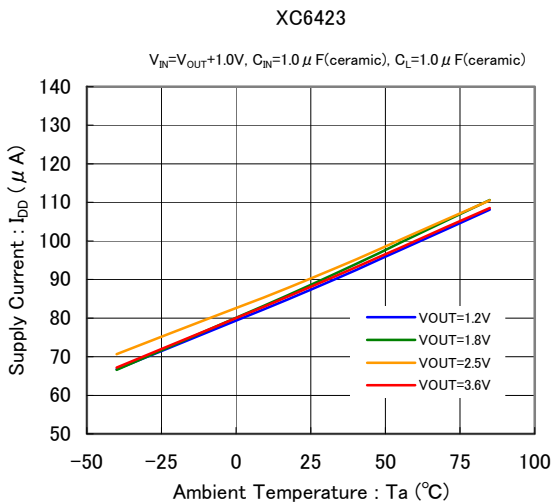

(7) EN Threshold Voltage vs. Ambient Temperature

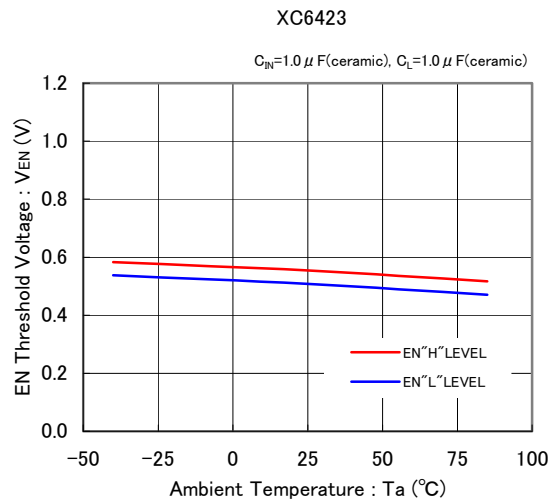

TYPICAL PERFORMANCE CHARACTERISTICS (Continued)

(8) Rising Response Time

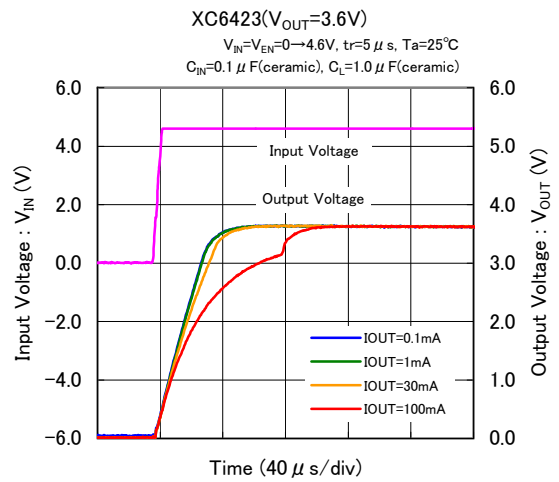
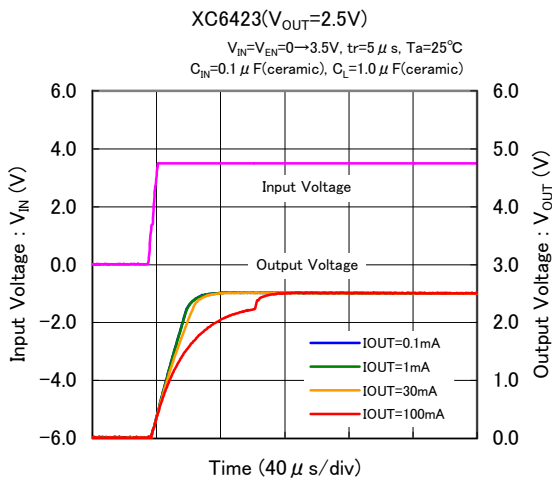
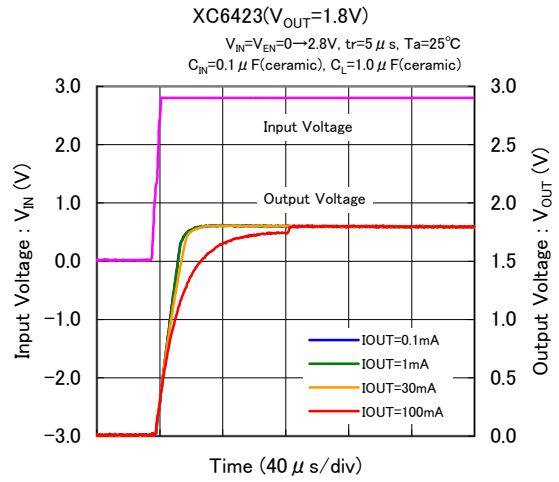
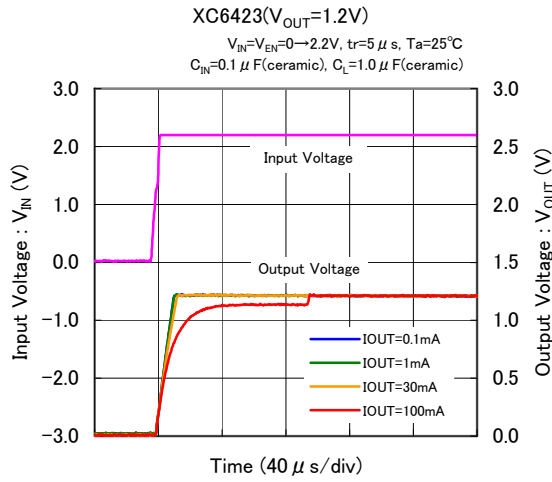

(9) Input Transient Response

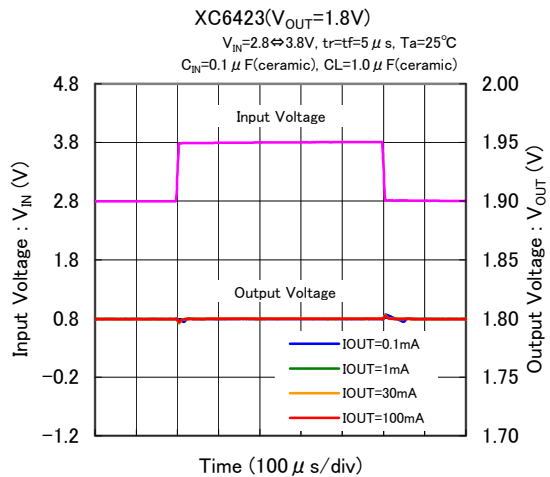
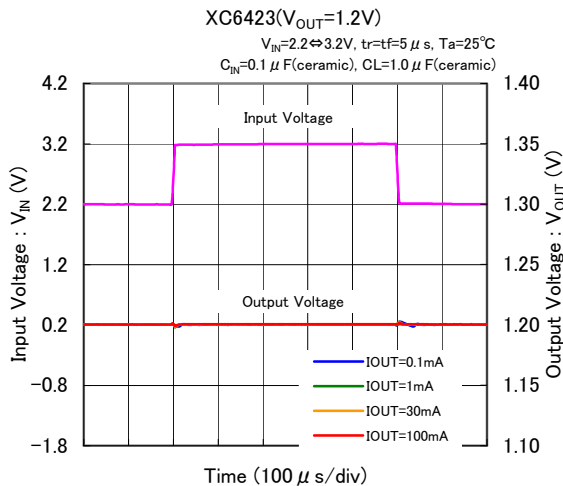

■ TYPICAL PERFORMANCE CHARACTERISTICS (Continued)

(9) Input Transient Response (Continued)

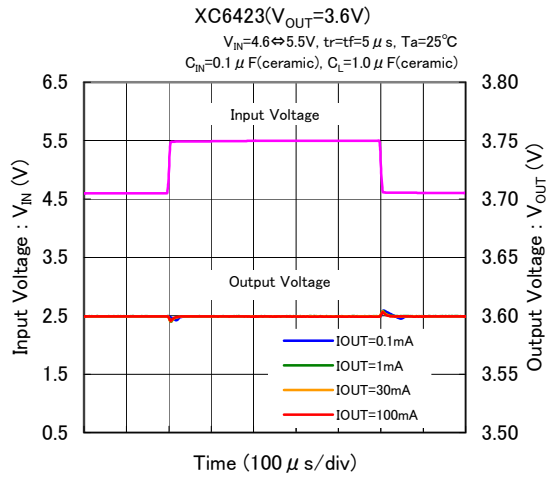
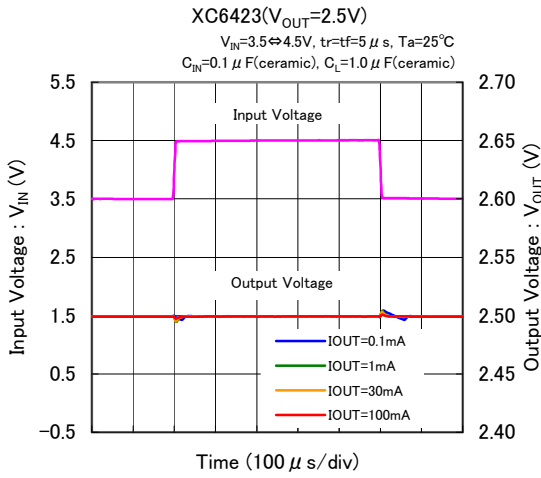

(10) Load Transient Response

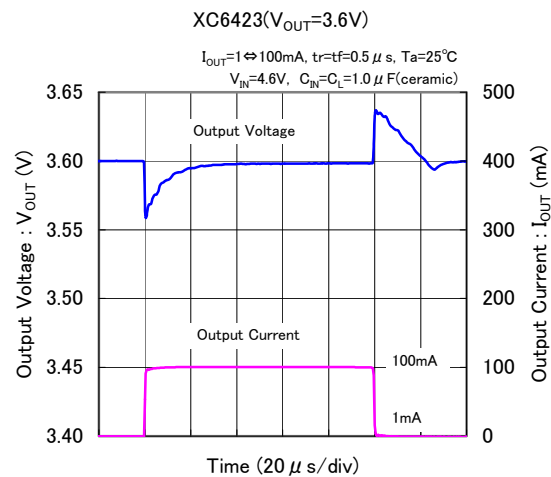
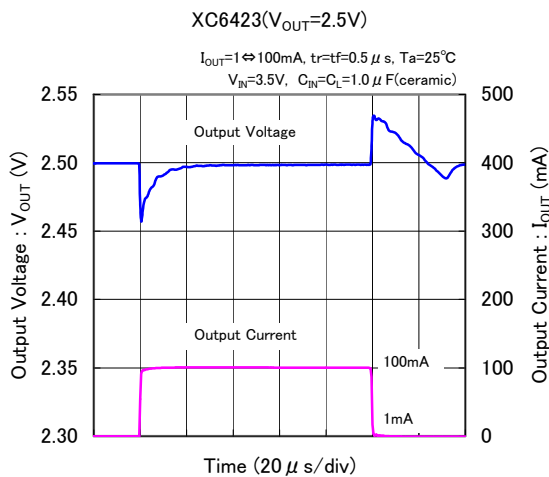
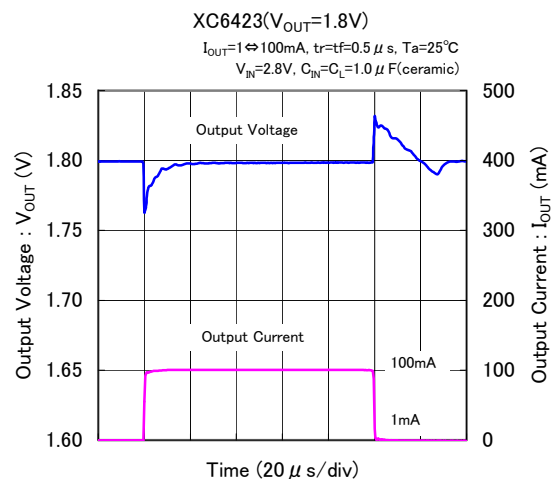
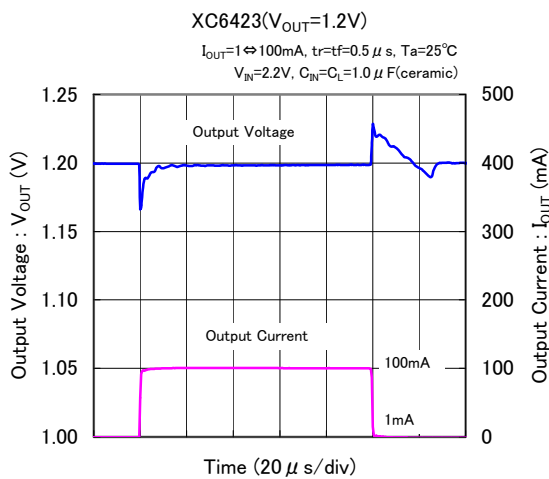

TYPICAL PERFORMANCE CHARACTERISTICS (Continued)

(11) EN Rising Response Time

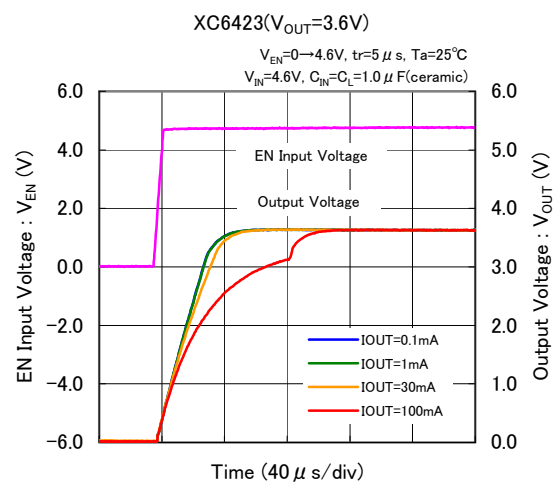
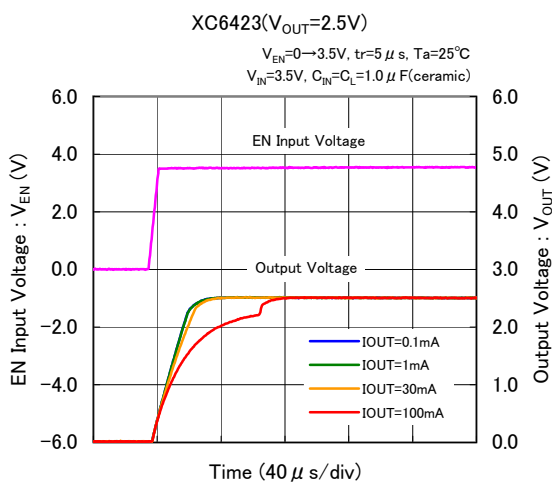
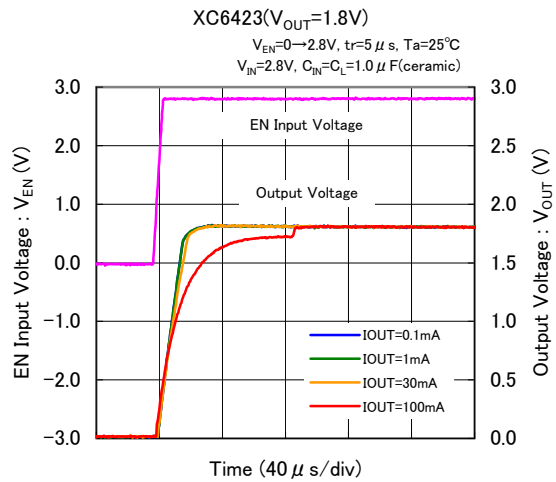
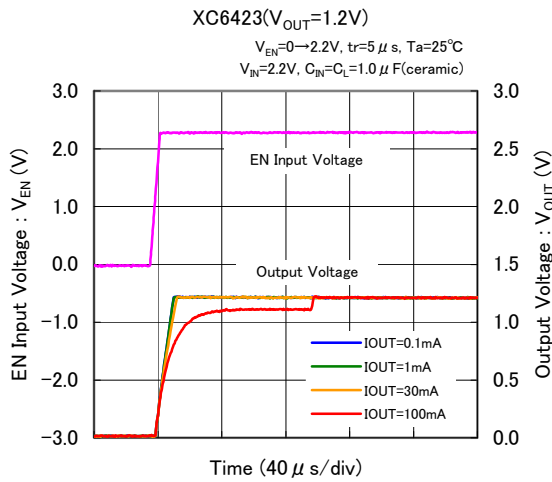

(12) Power Supply Rejection Ratio

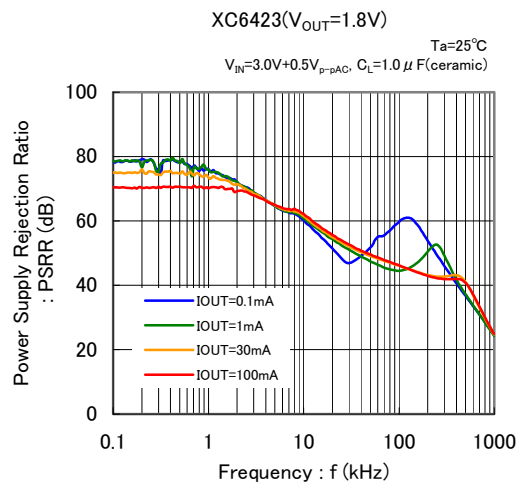
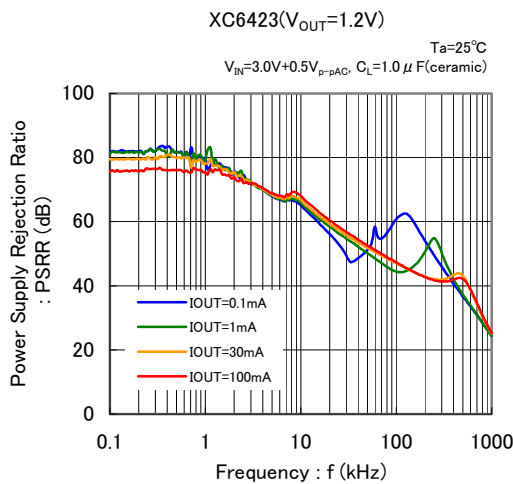

■ TYPICAL PERFORMANCE CHARACTERISTICS (Continued)

(12) Power Supply Rejection Ratio (Continued)

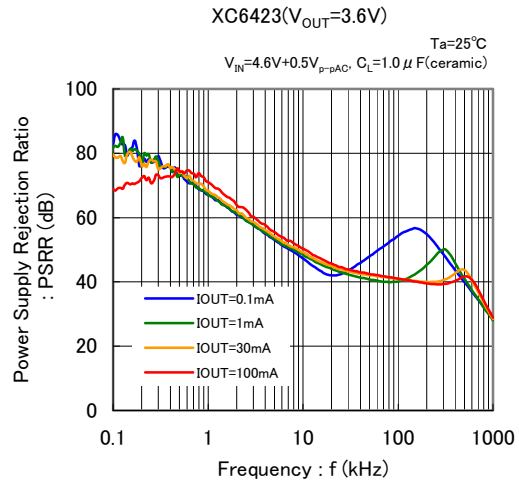
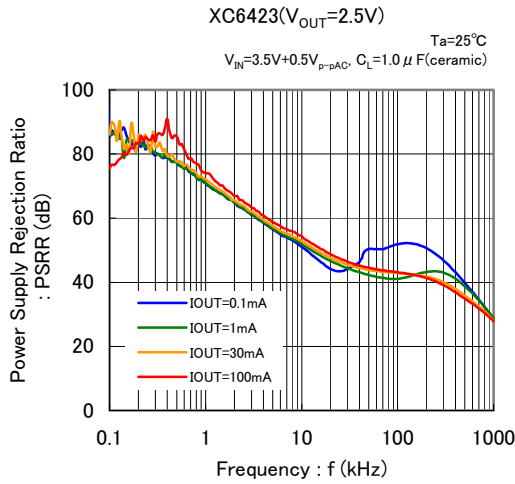

(13) Inrush Current Response

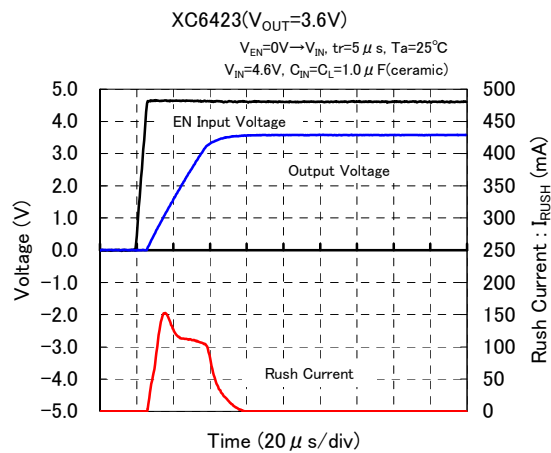
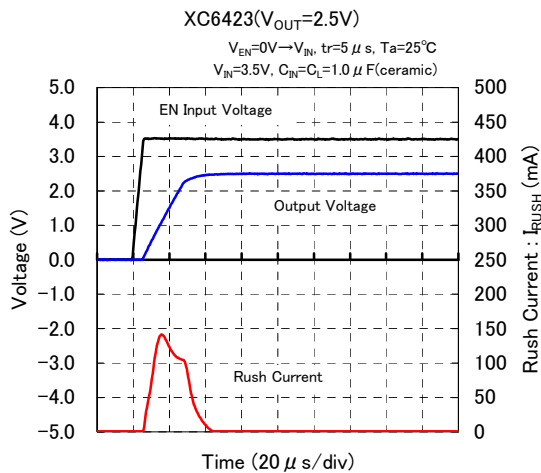
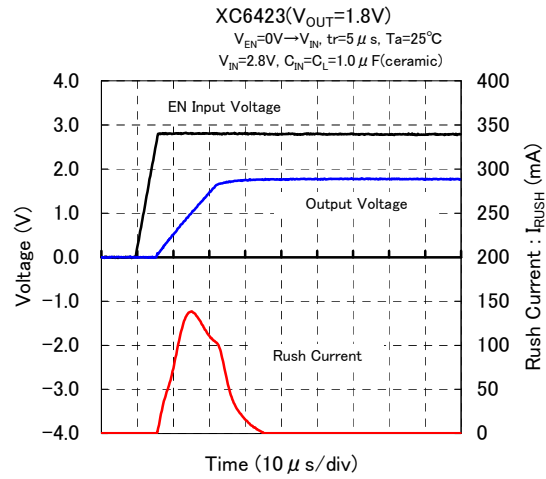
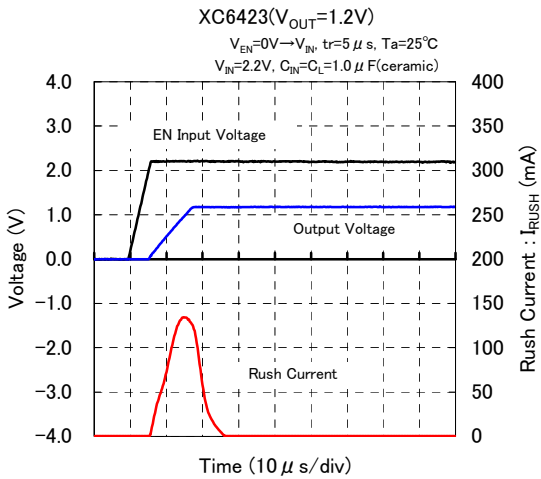

TYPICAL PERFORMANCE CHARACTERISTICS (Continued)

(14) Cross Talk

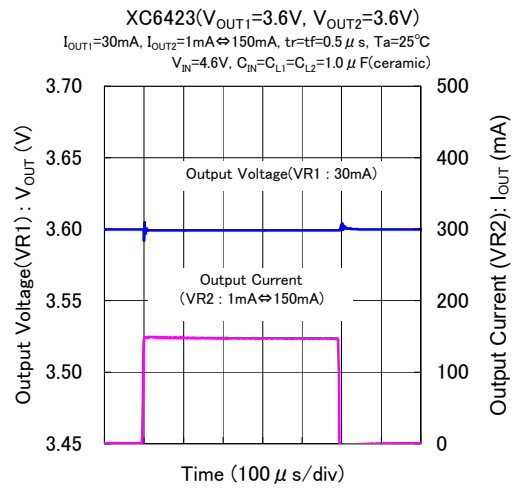
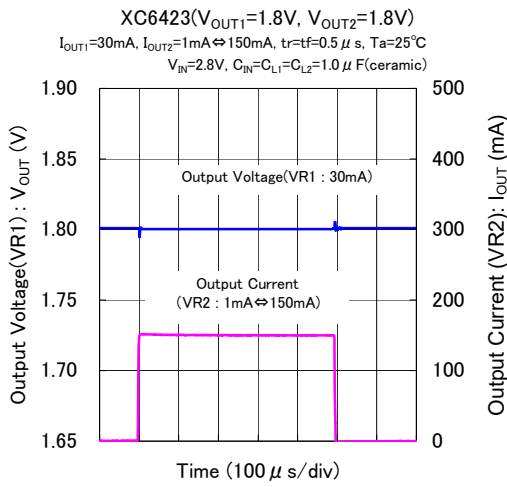

PACKAGING INFORMATION

● LGA-6A01 (unit:mm)

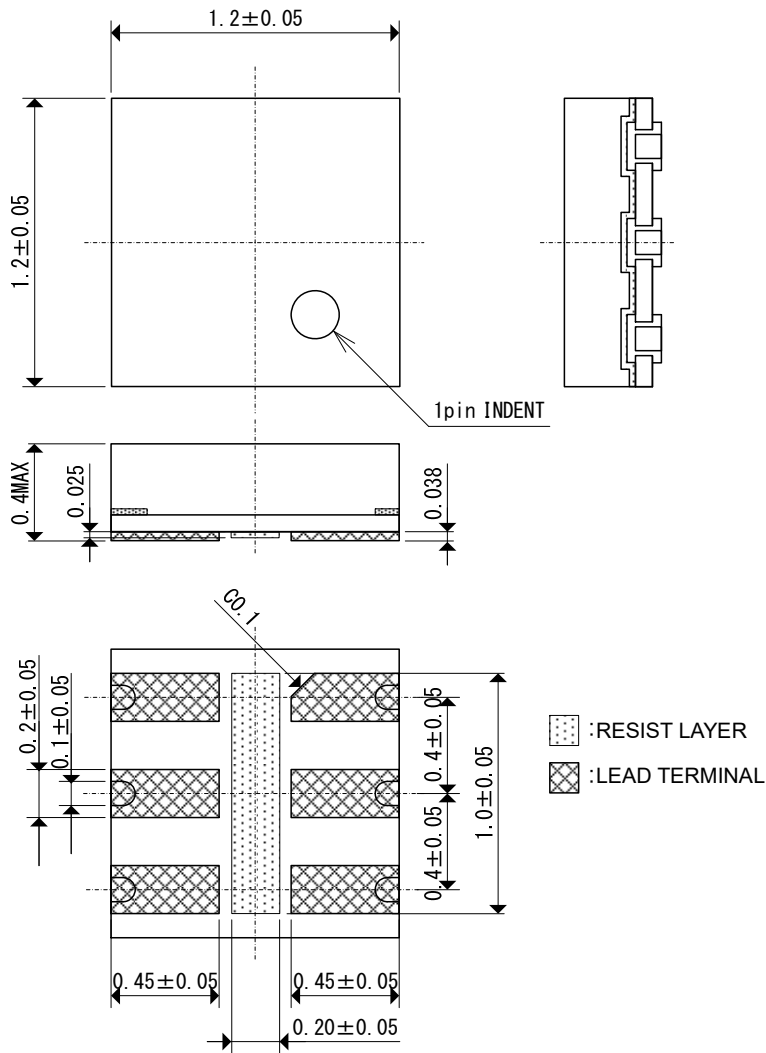

● LGA-6A01 Power Dissipation

Power dissipation data for the LGA-6A01 is shown in this page.
 The value of power dissipation varies with the mount board conditions.
 Please use this data as the reference data taken in the following condition.

1. Measurement Condition

- Condition : Mount on a board
- Ambient : Natural convection
- Soldering : Lead (Pb) free
- Board Dimensions : 40mm×40mm (1600mm² in one side)
- Metal Area : 1st Metal Layer about 50%
 2nd Inner Metal Layer about 50%
 3rd Inner Metal Layer about 50%
 4th Metal Layer about 50%
 Each heat sink back metal is connected to the Inner layers respectively.
- Material : Glass Epoxy (FR-4)
- Thickness : 1.0 mm
- Through-hole : 4 x 0.4 Diameter

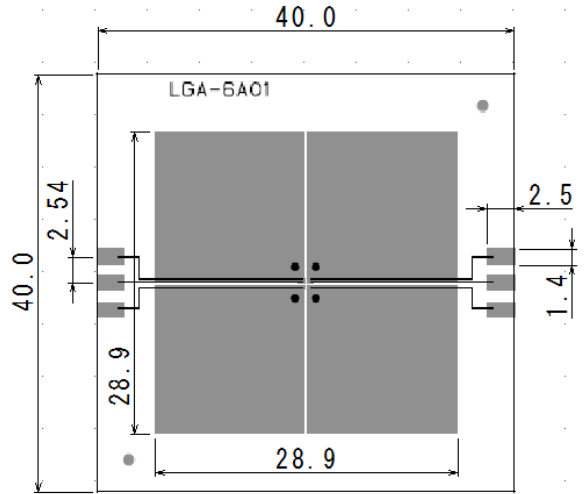

Evaluation Board (Unit: mm)

2. Power Dissipation vs. Ambient Temperature Board Mount

Board Mount (Tjmax=125°C)

Ambient Temperature (°C)	Power Dissipation Pd (mW)	Thermal Resistance (°C/W)
25	650	153.85
85	260	

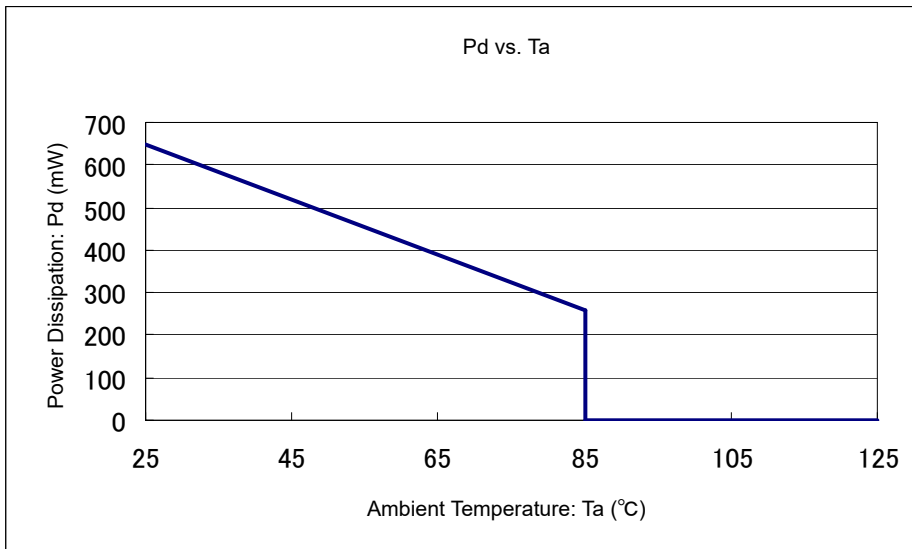

MARKING RULE

① represents product series

MARK	PRODUCT SERIES
1	XC6423*****-G

②,③ represents output voltage

MARK		PRODUCT SERIES
②	③	
0	1	XC6423**01**-G

④,⑤ represents production lot number

01~09, 0A~0Z, 11~9Z, A1~A9, AA~AZ, B1~ZZ in order.

(G, I, J, O, Q, W excluded)

* No character inversion used.

LGA-6A01

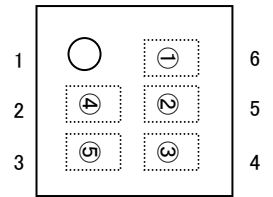

1. The products and product specifications contained herein are subject to change without notice to improve performance characteristics. Consult us, or our representatives before use, to confirm that the information in this datasheet is up to date.
2. We assume no responsibility for any infringement of patents, patent rights, or other rights arising from the use of any information and circuitry in this datasheet.
3. Please ensure suitable shipping controls (including fail-safe designs and aging protection) are in force for equipment employing products listed in this datasheet.
4. The products in this datasheet are not developed, designed, or approved for use with such equipment whose failure or malfunction can be reasonably expected to directly endanger the life of, or cause significant injury to, the user.
(e.g. Atomic energy; aerospace; transport; combustion and associated safety equipment thereof.)
5. Please use the products listed in this datasheet within the specified ranges.
Should you wish to use the products under conditions exceeding the specifications, please consult us or our representatives.
6. We assume no responsibility for damage or loss due to abnormal use.
7. All rights reserved. No part of this datasheet may be copied or reproduced without the prior permission of TOREX SEMICONDUCTOR LTD.

TOREX SEMICONDUCTOR LTD.

单击下面可查看定价，库存，交付和生命周期等信息

[>>Torex Semiconductor\(特瑞仕\)](#)