

300mA Small High Speed Dual LDO Regulator, Built-in Inrush Current Protection

■ GENERAL DESCRIPTION

The XC6421 series is an ultra small CMOS dual LDO regulator, mounting 300mA 2-channel small high speed LDO.

The series features high accuracy, high ripple rejection and low dropout voltage.

The series is capable of high density board installation by the ultra small package of two low on-resistance regulators. Both output accuracies are $\pm 1\%$ by laser trimming.

Each regulator can be turned off independently to be in stand-by mode by controlling EN pin.

In this state, the electric charge at the output capacitor (C_L) is discharged via the internal auto-discharge switch, and as a result the V_{OUT} voltage quickly returns to the V_{SS} level.

The output stabilization capacitor (C_L) is also compatible with low ESR ceramic capacitors.

The high level of output stability is maintained even during frequent load fluctuations, due to the excellent transient response performance.

Over current protection circuit and over heat protection circuit are mounted, these circuits start working when output current reaches junction temperature or limit current.

The two regulators are completely isolated so that a cross talk during load fluctuations is minimized

■ APPLICATIONS

- Smart phones / Mobile phones
- Portable game consoles
- Digital audio equipments
- Digital still cameras / Camcorders

■ FEATURES

Maximum Output Current	: 300mA
Operating Voltage Range	: 1.6V~5.5V
Output Voltages	: 1.2V~3.6V (0.05V increments)
Output Accuracy	: $\pm 1\%$ ($V_{OUT} \geq 2.00V$) $\pm 20mV$ ($V_{OUT} \leq 1.95V$)
Dropout Voltage	: 210mV@ $I_{OUT}=300mA$ ($V_{OUT}=3.0V$)
Low Power Consumption	: 90 μA / ch (TYP.)
Stand-by Current	: 0.1 μA
Ripple Rejection	: 75dB@1kHz
ON/OFF Control	: Active High C_L Discharge
Protection	: Current Limit 450mA (TYP.) Short Circuit 125mA (TYP.) Inrush Current Protection Thermal Shutdown
Low ESR Capacitor	: 1.0 μF Ceramic Capacitor
Operating Ambient Temperature	: $-40^\circ C \sim +85^\circ C$
Package	: USP-6C
Environmentally Friendly	: EU RoHS Compliant, Pb Free

■ TYPICAL APPLICATION CIRCUITS ■ TYPICAL PERFORMANCE CHARACTERISTICS

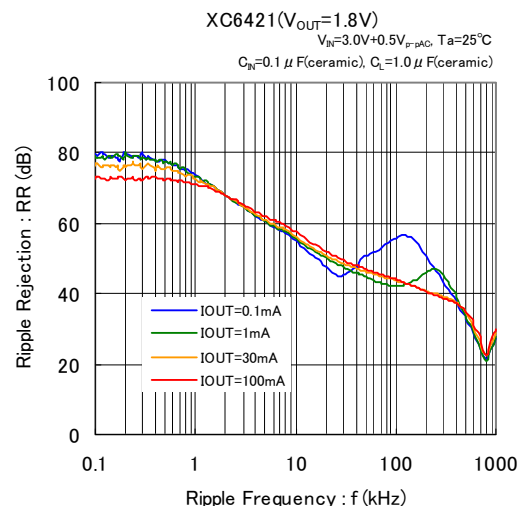
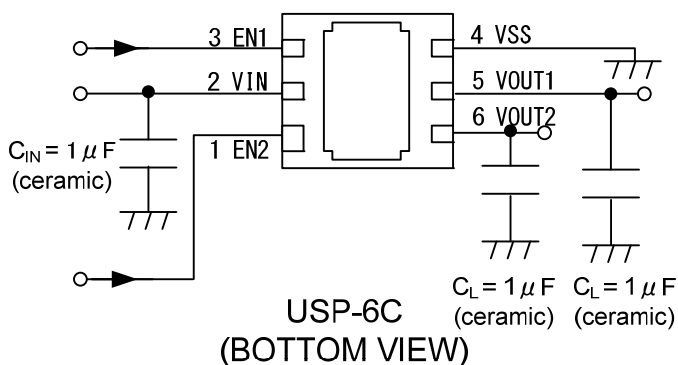

■ PRODUCT CLASSIFICATION

● Ordering Information
XC6421①②③④⑤⑥-⑦^(*)

DESIGNATOR	ITEM	SYMBOL	DESCRIPTION
①	Basic Function	A	EN1: Active High , EN2: Active High Built-in Thermal Shutdown Inrush Current Protection V _{OUT1} : C _L Discharge, V _{OUT2} : C _L Discharge
②	Enable Pin	B	EN1: With Pull-down EN2: With Pull-down
③④	Output Voltage	01~	See the chart below
⑤⑥-⑦	Package (Order Unit)	ER-G	USP-6C (3,000pcs/Reel)

^(*) The "-G" suffix denotes Halogen and Antimony free as well as being fully EU RoHS compliant.

DESIGNATOR ③④: Output Voltage

③④	VR1(V)	VR2(V)	③④	VR1(V)	VR2(V)
01	1.20	1.20	34	2.80	3.00
02	1.20	1.50	35	2.80	3.30
03	1.20	2.50	36	1.20	3.60
04	1.20	2.85	37	3.60	1.20
05	1.20	3.00	38	1.20	2.80
06	1.20	3.30	39	3.30	2.00
07	1.50	1.50	40	3.00	3.30
08	1.50	1.80	41	3.30	3.30
09	1.50	2.50	42	1.30	1.50
10	1.50	2.85	43	2.60	2.80
11	1.50	3.00	44	3.10	3.30
12	1.50	3.30	45	1.50	2.60
13	1.80	1.80	46	2.60	3.30
14	1.80	2.50	47	3.40	3.40
15	2.85	2.85	48	2.85	2.60
16	1.80	2.85	49	3.30	1.80
17	1.80	3.00	50	1.80	1.20
18	3.00	1.80	51	3.10	3.10
19	1.80	3.30	52	1.50	3.10
20	2.50	2.50	53	3.30	2.80
21	2.50	2.80	54	3.00	2.80
22	2.50	2.85	55	3.30	3.00
23	3.30	1.50	56	3.60	3.60
24	2.50	3.00	57	3.30	3.10
25	2.50	3.30	58	3.10	3.00
26	2.85	3.00	59	3.10	2.90
27	2.85	3.30	60	3.10	2.50
28	3.00	3.00	61	3.00	2.90
29	1.20	1.80	62	3.00	2.50
30	1.30	2.80	63	1.80	1.90
31	1.50	2.80	64	1.80	1.85
32	1.80	2.80	65	1.70	1.70
33	2.80	2.80			

*For other output voltage combinations, please contact your local Torex sales office or representative.

PIN CONFIGURATION

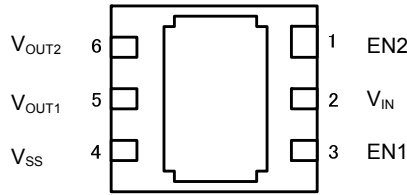

USP-6C
(BOTTOM VIEW)

* The dissipation pad for the USP-6C package should be solder-plated in recommended mount pattern and metal masking to enhance mounting strength and heat release. If the pad needs to be connected to other pins, it should be connected to the V_{SS} (No. 4) pin.

PIN ASSIGNMENT

PIN NUMBER	PIN NAME	FUNCTIONS
USP-6C		
1	EN2	ON/OFF Control 2
2	V_{IN}	Power Input
3	EN1	ON/OFF Control 1
4	V_{SS}	Ground
5	V_{OUT1}	Output 1
6	V_{OUT2}	Output 2

FUNCTION CHART

XC6421 Series, AB Type

PIN NAME	SIGNAL	STATUS
EN	L	Stand-by
	H	Active
	OPEN	Stand-by*

H=High Level , L=Low Level

* When the EN pin is left open, an internal pull-down resistor maintains the EN pin voltage to be low.

ABSOLUTE MAXIMUM RATINGS

PARAMETER	SYMBOL	RATINGS	UNITS
Input Voltage	V_{IN}	$V_{SS}-0.3 \sim V_{SS} + 7.0$	V
Output Current	$I_{OUT1} + I_{OUT2}$	800 ⁽¹⁾	mA
Output Voltage 1, Output Voltage2	V_{OUT1}, V_{OUT2}	$V_{SS}-0.3 \sim V_{IN} + 0.3 \leq V_{SS} + 7.0$	V
EN1, EN2 Input Voltage	V_{EN1}, V_{EN2}	$V_{SS}-0.3 \sim V_{SS} + 7.0$	V
Power Dissipation	USP-6C	Pd	120
			1000 (40mm x 40mm Standard board) ⁽²⁾
			1250 (JEDEC board) ⁽²⁾
Operating Ambient Temperature	Topr	-40 ~ +85	°C
Storage Temperature	Tstg	-55 ~ +125	°C

⁽¹⁾ $P_d > \{ (V_{IN} - V_{OUT1}) \times I_{OUT1} + (V_{IN} - V_{OUT2}) \times I_{OUT2} \}$

⁽²⁾ The power dissipation figure shown is PCB mounted. Please see the power dissipation page for the mounting condition.

ELECTRICAL CHARACTERISTICS

XC6421 Series

Ta=25°C

Regulator 1, Regulator 2

PARAMETER	SYMBOL	CONDITIONS	MIN.	TYP.	MAX.	UNITS	CIRCUITS
Output Voltage	V _{OUT(E)} ⁽²⁾	V _{OUT} ≥ 2.0V, V _{EN} = V _{IN} , I _{OUT} = 10mA	V _{OUT(T)} × 0.99 ⁽²⁾	V _{OUT(T)} ⁽³⁾	V _{OUT(T)} × 1.01 ⁽²⁾	V	①
		V _{OUT} < 2.0V, V _{EN} = V _{IN} , I _{OUT} = 10mA	V _{OUT(T)} - 20mV ⁽²⁾	V _{OUT(T)} ⁽³⁾	V _{OUT(T)} + 20mV ⁽²⁾	V	①
Maximum Output Current	I _{OUTMAX}	V _{EN} = V _{IN}	300	-	-	mA	①
Load Regulation	ΔV _{OUT}	V _{EN} = V _{IN} , 0.1mA ≤ I _{OUT} ≤ 300mA	-	25	45	mV	①
Dropout Voltage ⁽⁴⁾	V _{dif}	I _{OUT} = 300mA, V _{EN} = V _{IN}	See the chart below			mV	①
Supply Current	I _{SS}	V _{EN} = V _{IN} , I _{OUT} = 0mA	-	90	190	μA	②
Stand-by Current	I _{STB}	V _{EN} = V _{SS}	-	0.01	0.1	μA	②
Line Regulation	ΔV _{OUT} / (ΔV _{IN} · V _{OUT})	2.5V ≤ V _{IN} ≤ 5.5V, (V _{OUT(T)} ≤ 2.0V), V _{EN} = V _{IN} , I _{OUT} = 30mA	-	0.02	0.1	%V	①
		V _{OUT(T)} + 0.5V ≤ V _{IN} ≤ 5.5V, (V _{OUT(T)} ≥ 2.05V), V _{EN} = V _{IN} , I _{OUT} = 30mA					
Input Voltage	V _{IN}	-	1.6	-	5.5	V	①
Output Voltage Temperature Characteristics (R&D Value)	ΔV _{OUT} / (ΔTa · V _{OUT})	V _{EN} = V _{IN} , I _{OUT} = 10mA, -40°C ≤ Ta ≤ 85°C	-	±100	-	ppm / °C	①
Power Supply Rejection Ratio	PSRR	V _{EN} = V _{IN} , V _{IN} = {V _{OUT(T)} + 1.0} + 0.5Vp-pAC I _{OUT} = 30mA, f = 1kHz	-	75	-	dB	③
Limit Current	I _{LIM}	V _{EN} = V _{IN}	310	450	-	mA	①
Short-Circuit Current	I _{SHORT}	V _{EN} = V _{IN} , V _{OUT} = V _{SS}	-	125	-	mA	①
EN"H"Level Voltage	V _{ENH}	-	1.0	-	5.5	V	①
EN"L"Level Voltage	V _{ENL}	-	0	-	0.3	V	①
EN"H"Level Current	I _{ENH}	V _{EN} = V _{IN} = 5.5V	2.9	6.0	9.5	μA	①
EN"L"Level Current	I _{ENL}	V _{EN} = V _{SS}	-0.1	-	0.1	μA	①
C _L Discharge Resistance	R _{DCHG}	V _{IN} = 5.5V, V _{EN} = V _{SS} , V _{OUT} = 2.0V	-	230	-	Ω	①
Inrush Current	I _{RUSH}	-	-	150	-	mA	①
Thermal Shutdown Detect Temperature	T _{TSD}	Junction Temperature	-	150	-	°C	①
Thermal Shutdown Release Temperature	T _{TSR}	Junction Temperature	-	125	-	°C	①
Thermal Shutdown Release Temperature	T _{TSD} - T _{TSR}	Junction Temperature	-	25	-	°C	①

NOTE:

Unless otherwise stated, {V_{IN} = V_{OUT(T)} + 1.0V}

Each channel is measured when the other channel is turned off (V_{EN} = V_{SS}).

⁽¹⁾V_{OUT(E)}: Effective output voltage (see the voltage chart)

(ie. The output voltage when "V_{OUT(T)} + 1.0V" is provided at the V_{IN} pin while maintaining a certain I_{OUT} value.

⁽²⁾Characteristics of the actual V_{OUT(E)} by nominal output voltage is shown in the voltage chart.

⁽³⁾V_{OUT(T)}: Nominal output voltage

⁽⁴⁾V_{dif} = {V_{IN1} - V_{OUT1}}

V_{OUT1}: A voltage equal to 98% of the output voltage whenever an amply stabilized {V_{OUT(T)} + 1.0V} is input with every I_{OUT}.

V_{IN1}: The input voltage when V_{OUT1} appears as input voltage is gradually decreased.

OUTPUT VOLTAGE CHART

Regulator 1, Regulator 2

● Voltage chart

Ta=25°C

NOMINAL OUTPUT VOLTAGE (V)	OUTPUT VOLTAGE (V)		DROPOUT VOLTAGE (mV)	
	V _{OUT(E)}		V _{dif}	
	MIN.	MAX.	TYP.	MAX.
1.200	1.1800	1.2200	580	680
1.250	1.2300	1.2700		
1.300	1.2800	1.3200	515	610
1.350	1.3300	1.3700		
1.400	1.3800	1.4200	460	550
1.450	1.4300	1.4700		
1.500	1.4800	1.5200		
1.550	1.5300	1.5700		
1.600	1.5800	1.6200	380	450
1.650	1.6300	1.6700		
1.700	1.6800	1.7200		
1.750	1.7300	1.7700		
1.800	1.7800	1.8200	330	390
1.850	1.8300	1.8700		
1.900	1.8800	1.9200		
1.950	1.9300	1.9700		
2.000	1.9800	2.0200	295	350
2.050	2.0295	2.0705		
2.100	2.0790	2.1210		
2.150	2.1285	2.1715		
2.200	2.1780	2.2220		
2.250	2.2275	2.2725		
2.300	2.2770	2.3230		
2.350	2.3265	2.3735		
2.400	2.3760	2.4240		
2.450	2.4255	2.4745		

NOMINAL OUTPUT VOLTAGE (V)	OUTPUT VOLTAGE (V)		DROPOUT VOLTAGE (mV)	
	V _{OUT(E)}		V _{dif}	
	MIN.	MAX.	TYP.	MAX.
2.500	2.4750	2.5250	240	290
2.550	2.5245	2.5755		
2.600	2.5740	2.6260		
2.650	2.6235	2.6765		
2.700	2.6730	2.7270		
2.750	2.7225	2.7775		
2.800	2.7720	2.8280		
2.850	2.8215	2.8785		
2.900	2.8710	2.9290		
2.950	2.9205	2.9795		
3.000	2.9700	3.0300	210	260
3.050	3.0195	3.0805		
3.100	3.0690	3.1310		
3.150	3.1185	3.1815		
3.200	3.1680	3.2320		
3.250	3.2175	3.2825		
3.300	3.2670	3.3330		
3.350	3.3165	3.3835		
3.400	3.3660	3.4340		
3.450	3.4155	3.4845		
3.500	3.4650	3.5350		
3.550	3.5145	3.5855		
3.600	3.5640	3.6360		

TEST CIRCUITS

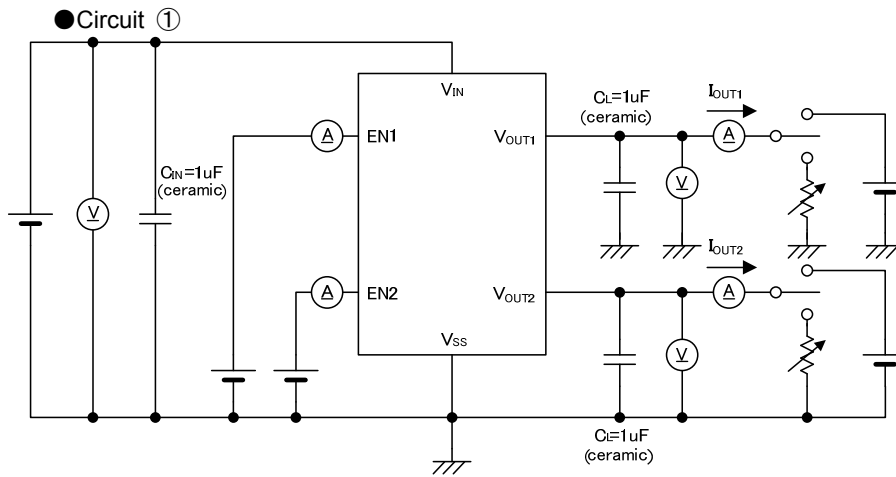

● Circuit ②

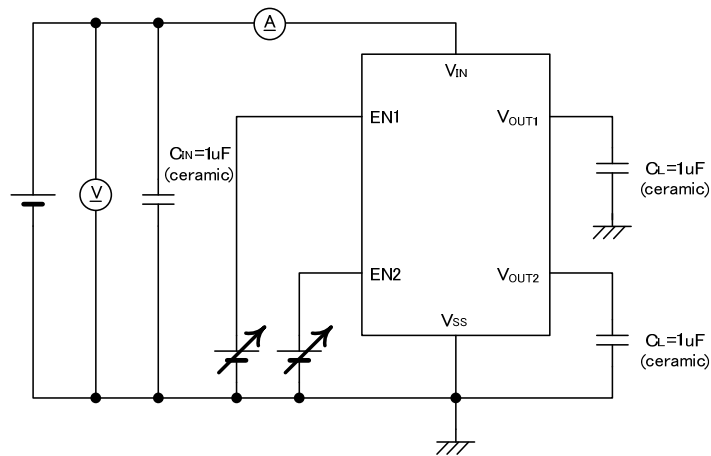

● Circuit ③

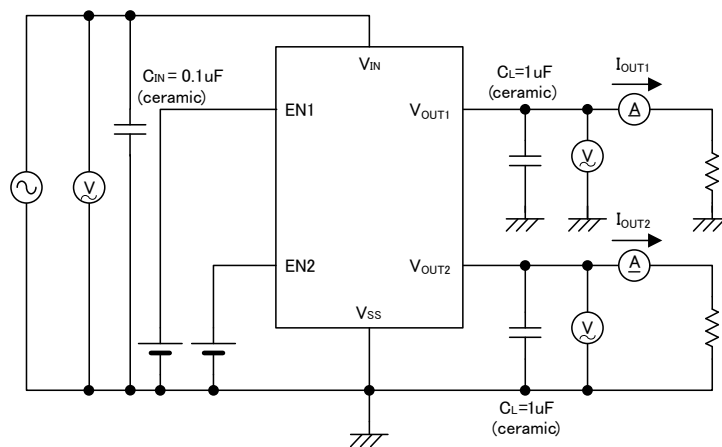

OPERATIONAL EXPLANATION

The voltage divided by resistors Rx1 & Rx2 is compared with the internal reference voltage by the error amplifier. The P-channel MOSFET which is connected to the Output pin (V_{OUT}) is then driven by the subsequent control signal. The output voltage at the Output pin (V_{OUT}) is controlled and stabilized by a system of negative feedback. The current limit circuit, short circuit protection and thermal protection operate in relation to the level of output current and heat dissipation. Further, the IC's internal circuitry can be shutdown via the EN pin signal.

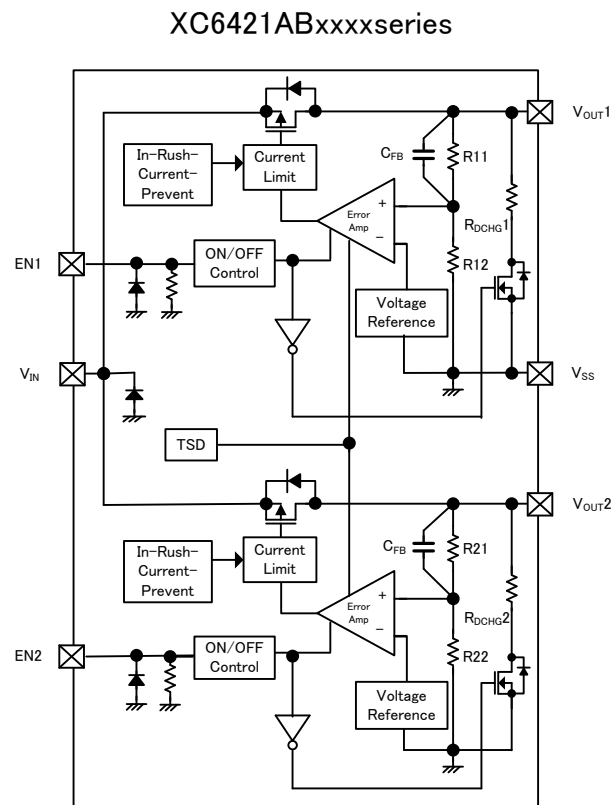

<Low ESR Capacitor>

The XC6421 series needs an output capacitor (C_L) for phase compensation. In order to ensure the stable phase compensation, please place an output capacitor (C_L) of $1.0 \mu\text{F}$ or bigger at the V_{OUT} pin and V_{SS} pin as close as possible. For a stable power input, please connect an input capacitor (C_{IN}) of $1.0 \mu\text{F}$ between V_{IN} pin and V_{SS} pin.

<Current Limiter, Short-Circuit Protection>

The XC6421 series has current limiter and droop shape of fold-back circuit. When the load current reaches the current limit, the droop current limiter circuit operates and the output voltage drops. When the output voltage dropped, the fold-back circuit operates and the output current goes to decrease. The output current finally falls at the level of 125mA when the output pin is short-circuited.

<EN Pin>

The IC's internal circuitry can be shutdown via the signal from the EN pin. In shutdown mode, the XC6421 series enables the electric charge at the output capacitor (C_L) to be discharged via the internal auto-discharge switch, and as a result the output pin (V_{OUT}) quickly returns to the ground pin (V_{SS}) level.

On the other hand, the XC6421 series has a pull-down resistor at the EN pin inside, so that the EN pin input current flows. If this EN pin voltage is set with the specified voltage range, the logic is fixed and the IC will operate normally. However, the supply current may increase as a result of shoot-through current in the IC's internal circuitry when a medium voltage is input to the EN pin.

■ OPERATIONAL EXPLANATION (Continued)

<C_L Auto-Discharge Function>

XC6421 series can quickly discharge the electric charge at the output capacitor (C_L), when a low signal is inputted to the EN pin, which enables a part of the IC circuit put into OFF state, via the N-channel transistor located between the V_{OUT} pin and the V_{SS} pin (cf. BLOCK DIAGRAM). The C_L discharge resistance is set to 230Ω when V_{IN} is 5.5V (TYP.) and V_{OUT} is 2.0V (TYP.). Moreover, discharge time of the output capacitor (C_L) is set by the C_L auto-discharge resistance and the output capacitance (C_L). By setting time constant of a C_L auto-discharge resistance [R_{DCHG}] and an output capacitance (C_L) as τ ($\tau = C_L \times R_{DCHG}$), the output voltage after discharge via the N channel transistor is calculated by the following formulas.

$$V = V_{OUT(E)} \times e^{-t/\tau}, \quad \text{or} \quad t = \tau \ln (V_{OUT(E)} / V)$$

V : Output voltage after discharge

V_{OUT(E)} : Output voltage

t: Discharge time,

τ : R_{DCHG} × C_L

C_L : Output capacitance

R_{DCHG} : C_L auto-discharge resistance

<Thermal Shutdown>

When the junction temperature of the built-in driver transistor reaches the temperature limit, the thermal shutdown circuit operates and the driver transistor will be set to OFF. The IC resumes its operation when the thermal shutdown function is released and the IC's operation is automatically restored because the junction temperature drops to the level of the thermal shutdown release voltage.

<Inrush Current Protection>

The inrush current protection circuit is built in the XC6421 series.

When the IC starts to operate, the protection circuit limits the inrush current as 150mA (TYP.) from input pin (V_{IN}) to output pin (V_{OUT}) for charging C_L capacitor.

■ NOTES ON USE

1. For temporary, transitional voltage drop or voltage rising phenomenon, the IC is liable to malfunction should the ratings be exceeded.
2. Where wiring impedance is high, operations may become unstable due to the noise and/or phase lag depending on output current. Please strengthen V_{IN} and V_{SS} wiring in particular.
3. Please wire the input capacitor (C_{IN}) and the output capacitor (C_L) as close to the IC as possible.
4. Torex places an importance on improving our products and its reliability.
However, by any possibility, we would request user fail-safe design and post-aging treatment on system or equipment.

TYPICAL PERFORMANCE CHARACTERISTICS

(1) OutputVoltage vs. OutputCurrent

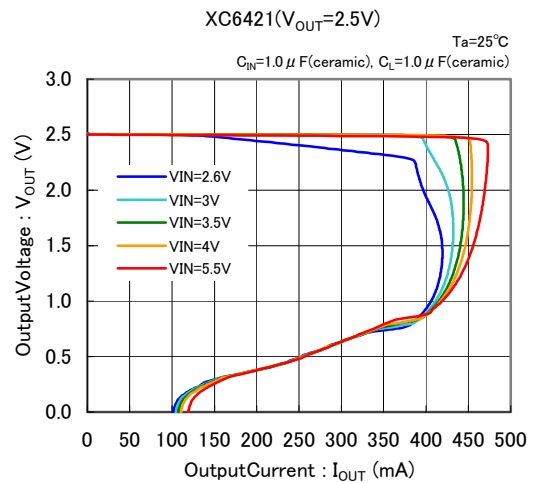
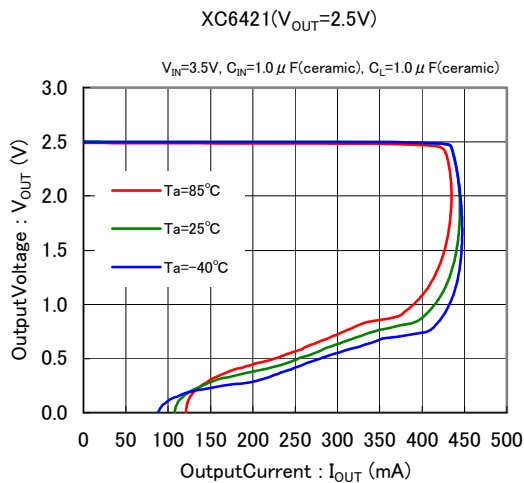
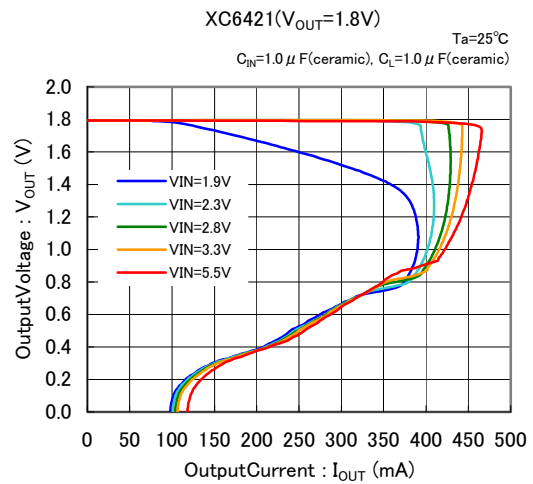
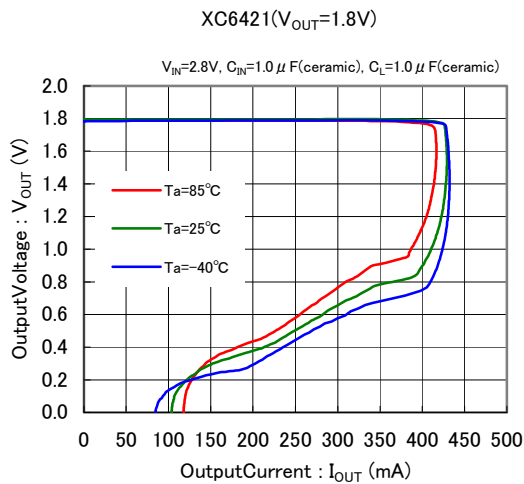
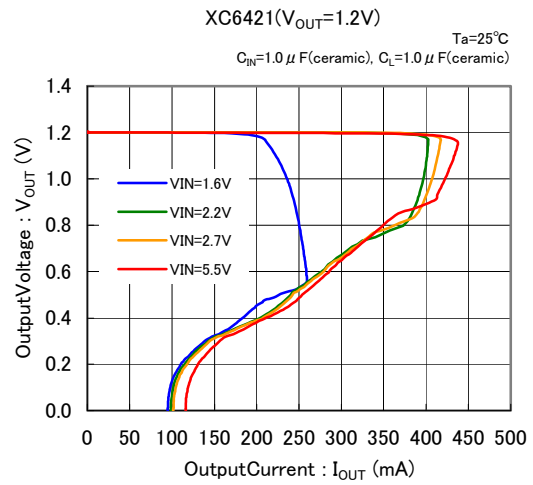
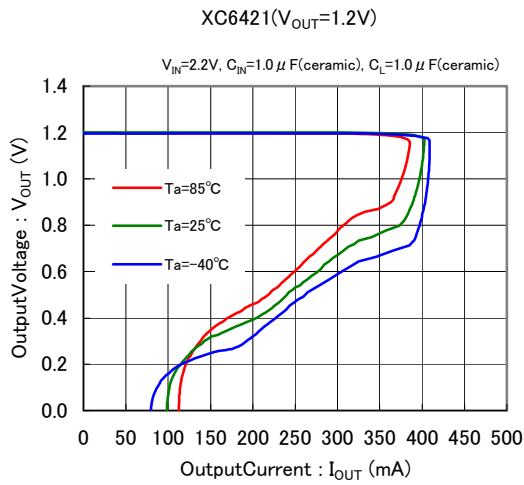

TYPICAL PERFORMANCE CHARACTERISTICS (Continued)

(1) OutputVoltage vs. OutputCurrent

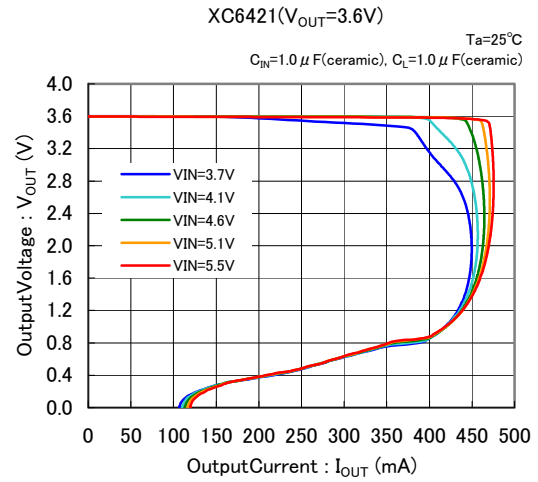
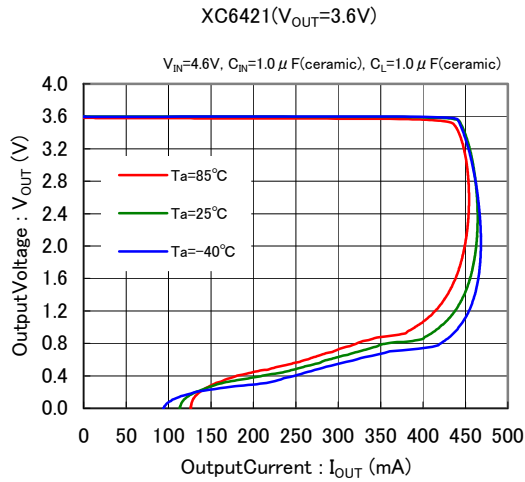

(2) OutputVoltage vs. InputVoltage

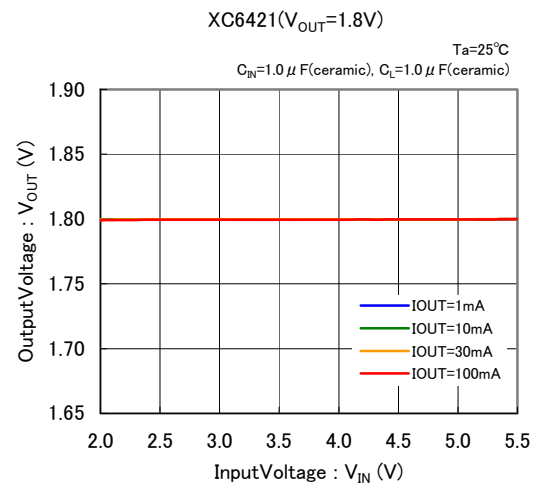
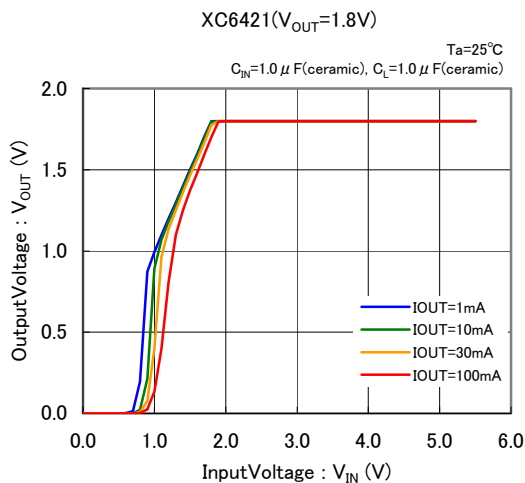
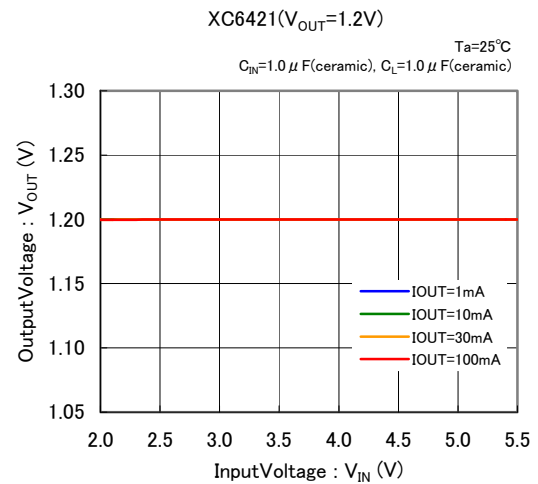
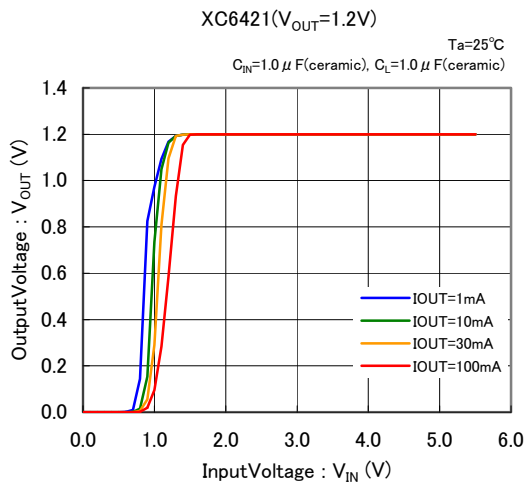

TYPICAL PERFORMANCE CHARACTERISTICS (Continued)

(2) Output Voltage vs. Input Voltage

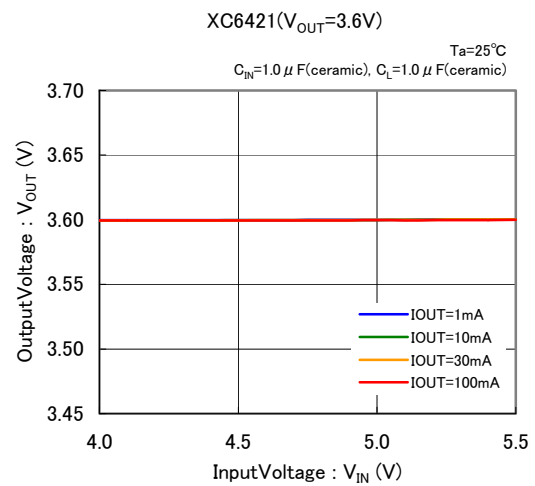
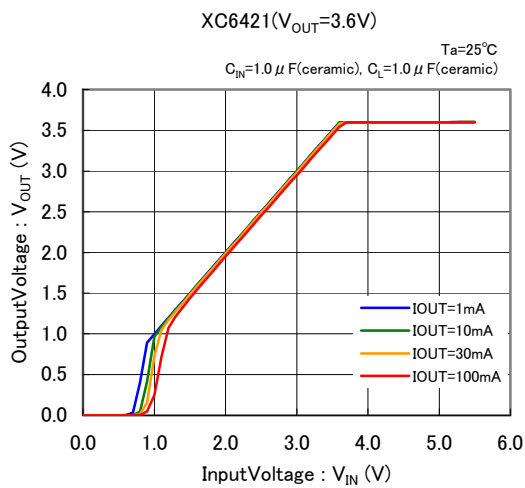
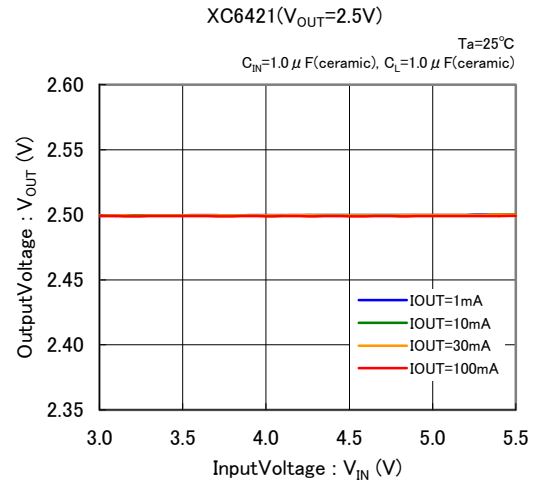
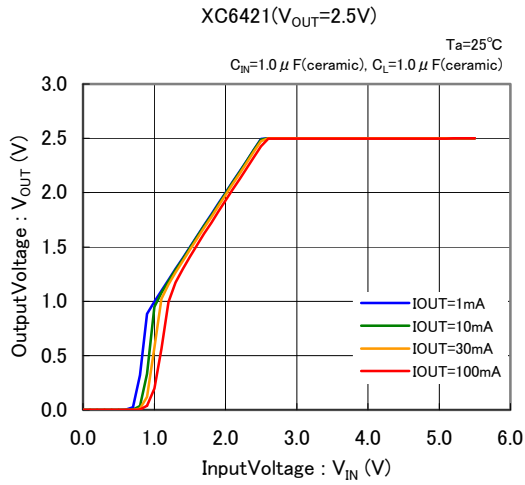

(3) Dropout Voltage vs. Output Current

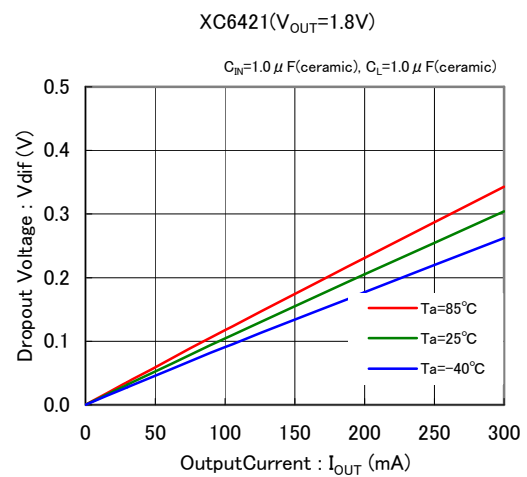
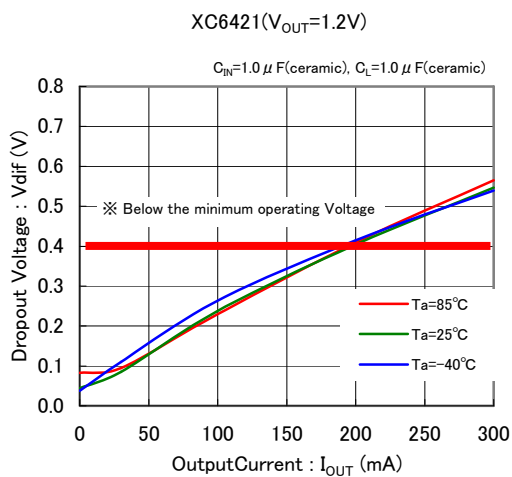

TYPICAL PERFORMANCE CHARACTERISTICS (Continued)

(3) DropoutVoltage vs. OutputCurrent

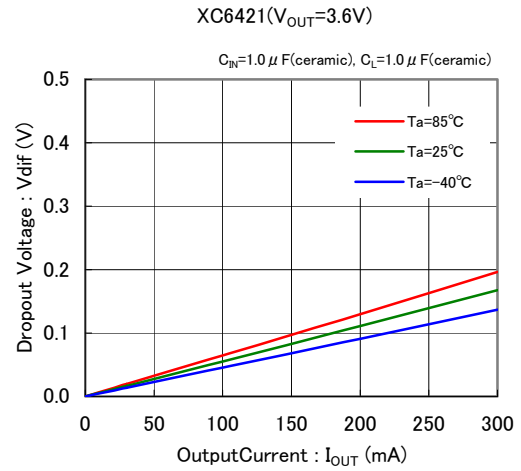
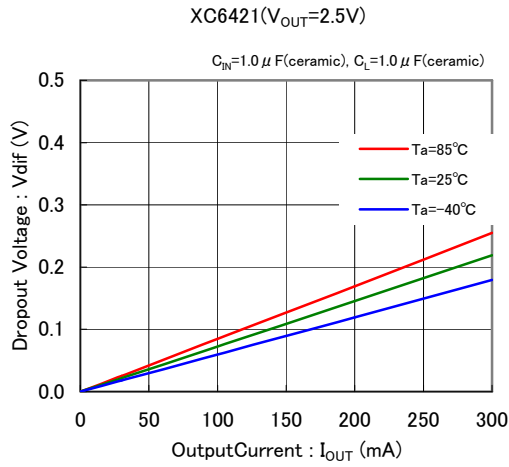

(4) SupplyCurrent vs. InputVoltage

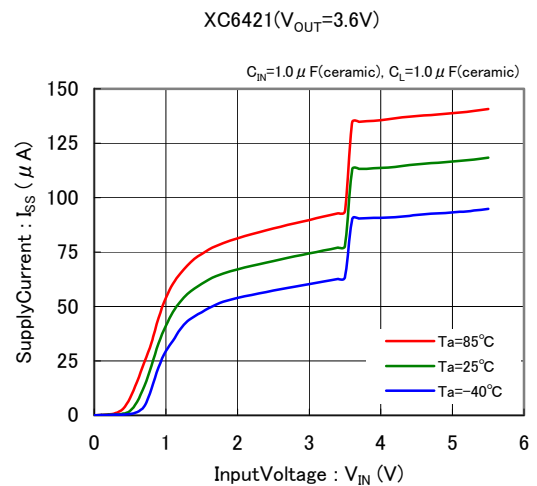
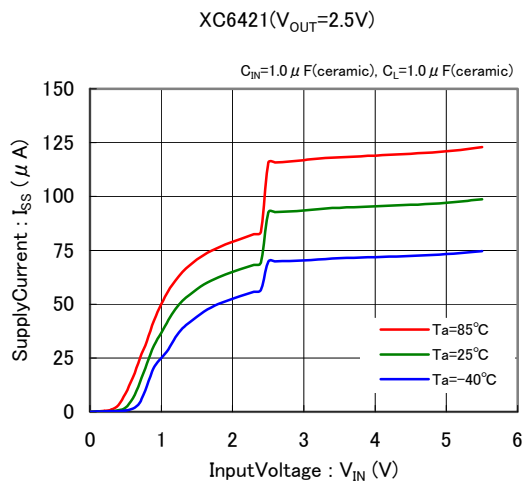
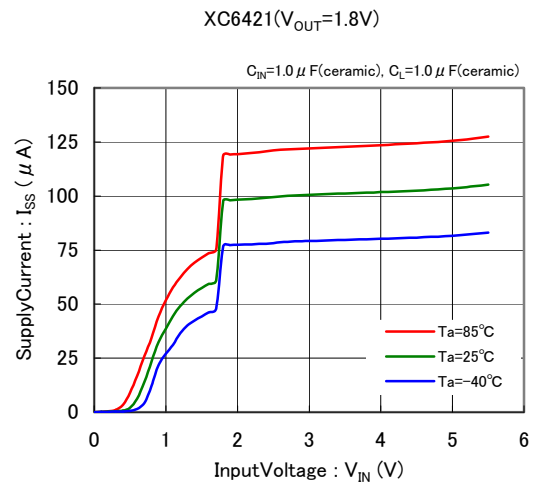
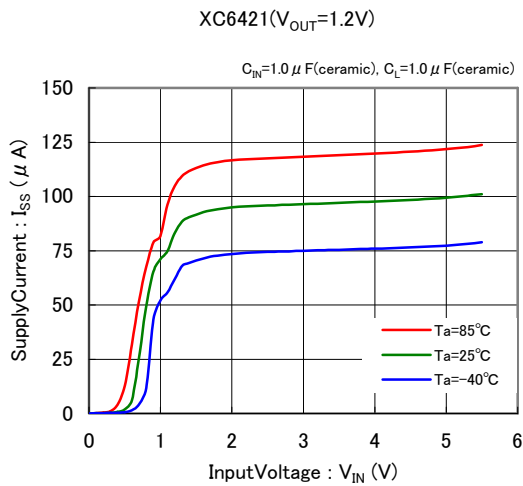

TYPICAL PERFORMANCE CHARACTERISTICS (Continued)

(5) Output Voltage vs. Ambient Temperature

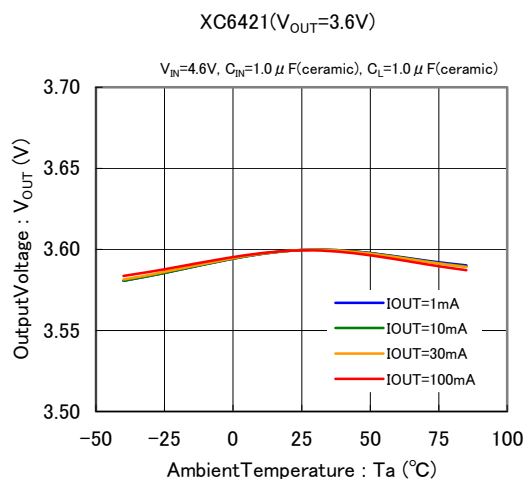
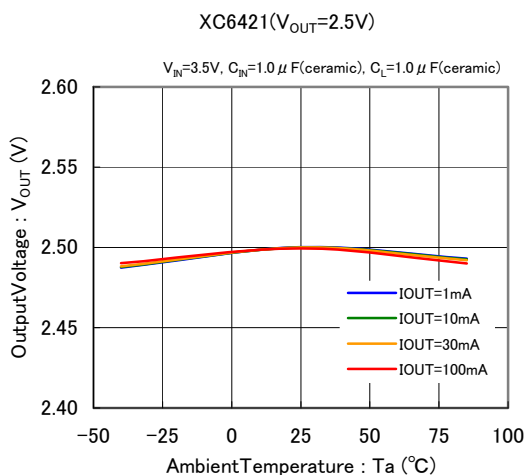
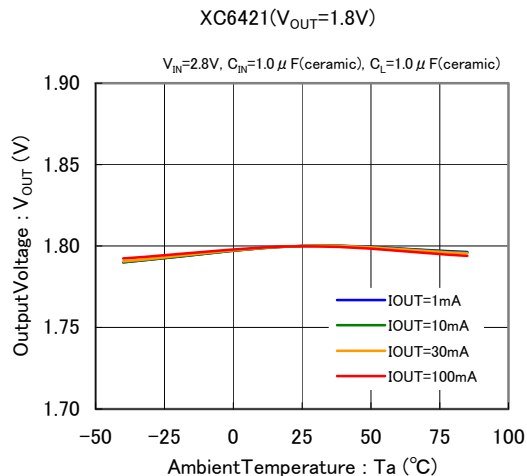
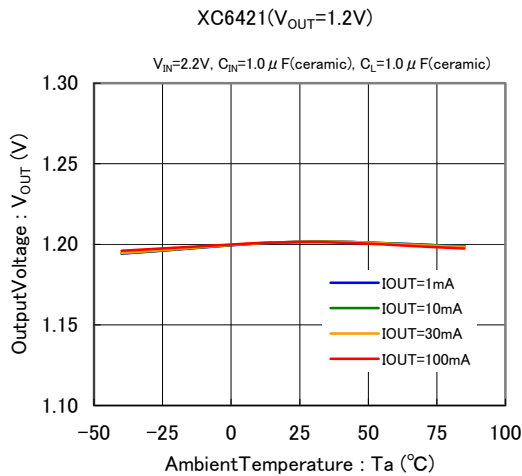

(6) Supply Current vs. Ambient Temperature

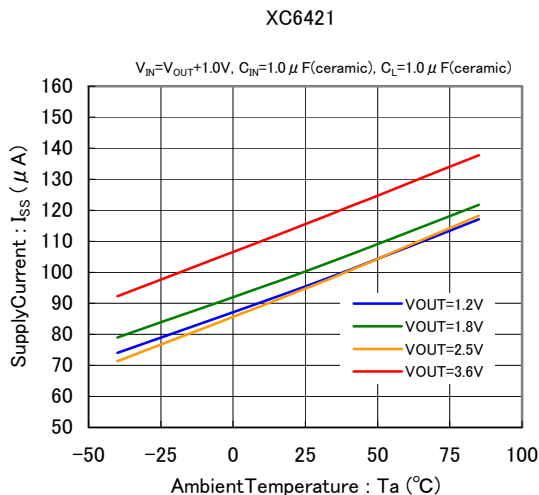

(7) EN Threshold Voltage vs. Ambient Temperature

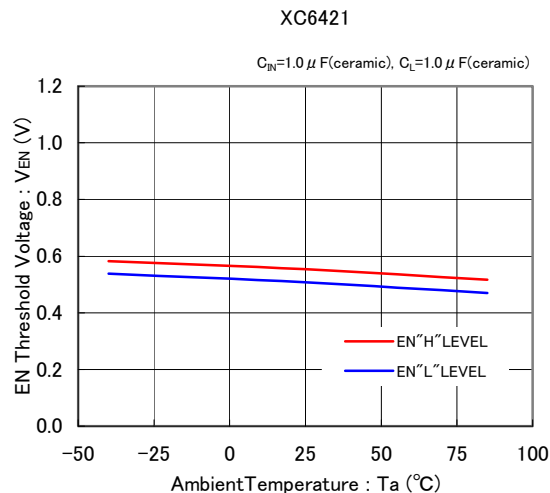

TYPICAL PERFORMANCE CHARACTERISTICS (Continued)

(8) Rising Response Time

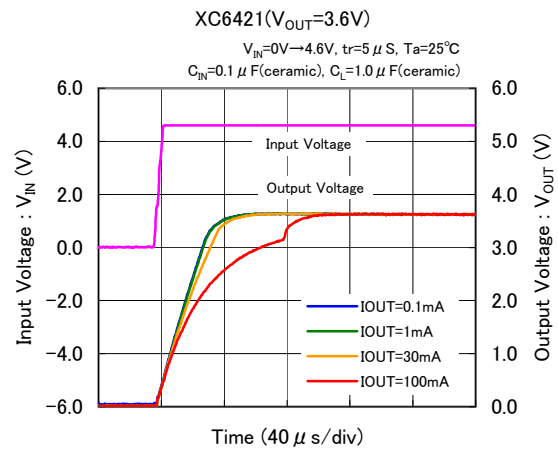
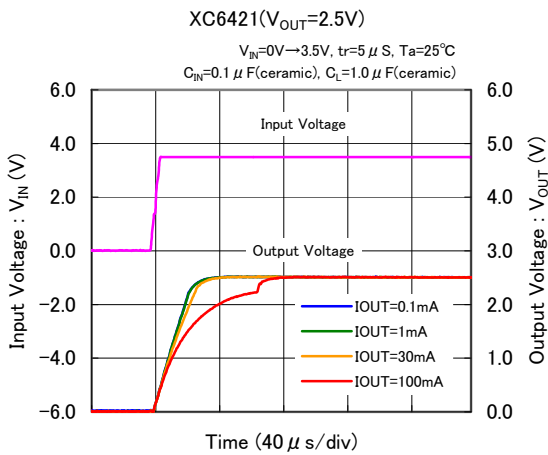
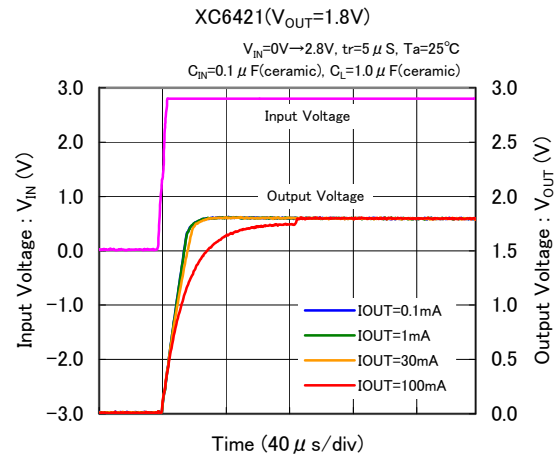
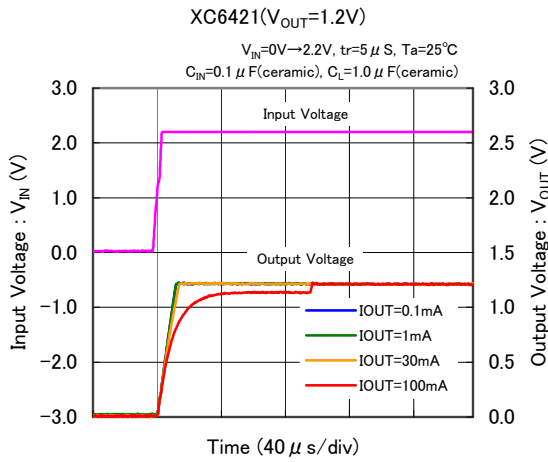

(9) Input Transient Response

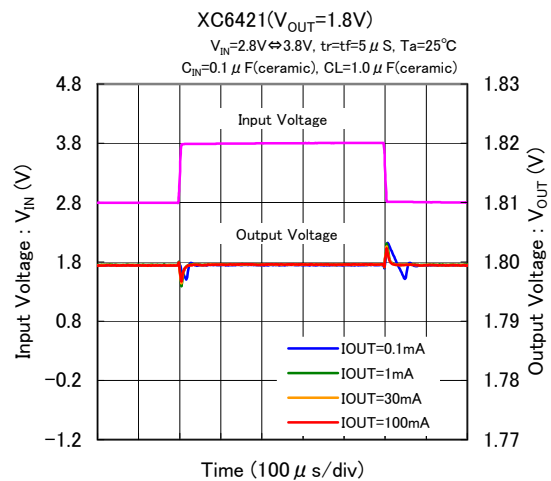
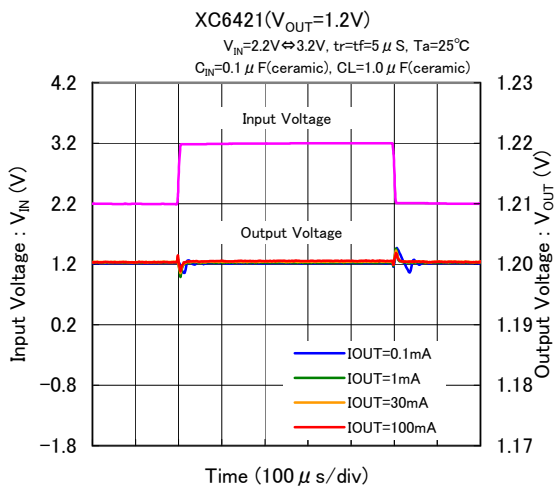

TYPICAL PERFORMANCE CHARACTERISTICS (Continued)

(9) Input Transient Response

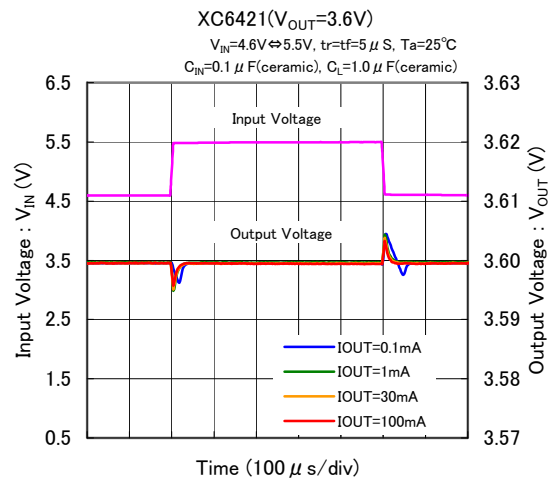
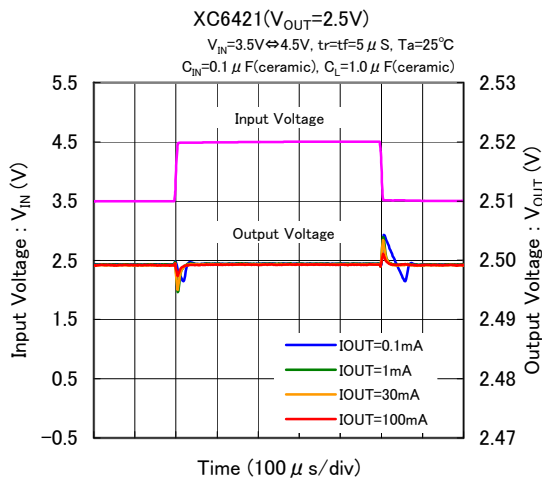

(10) Load Transient Response

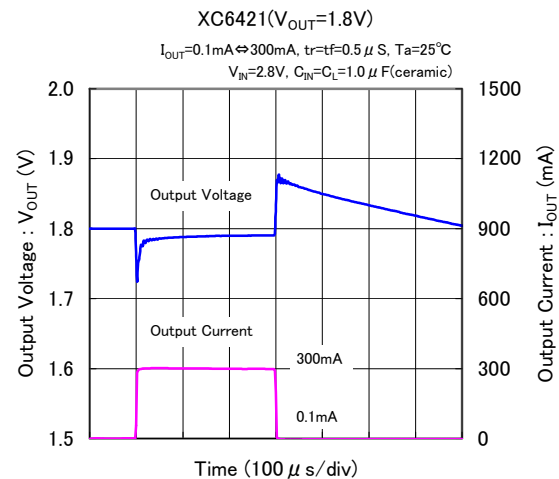
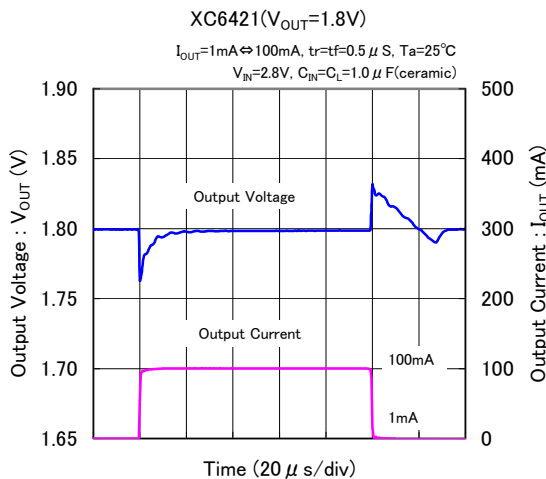
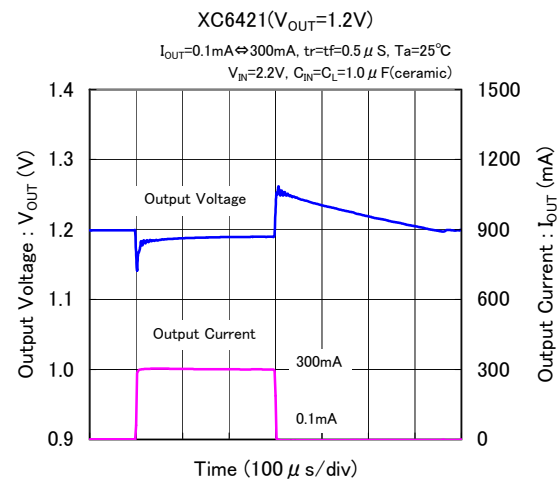
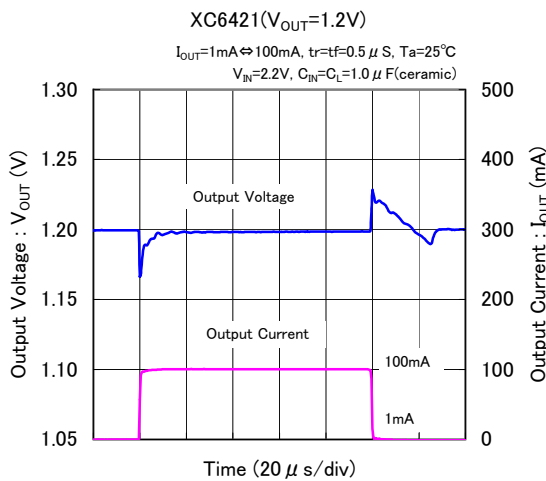

TYPICAL PERFORMANCE CHARACTERISTICS (Continued)

(10) Load Transient Response

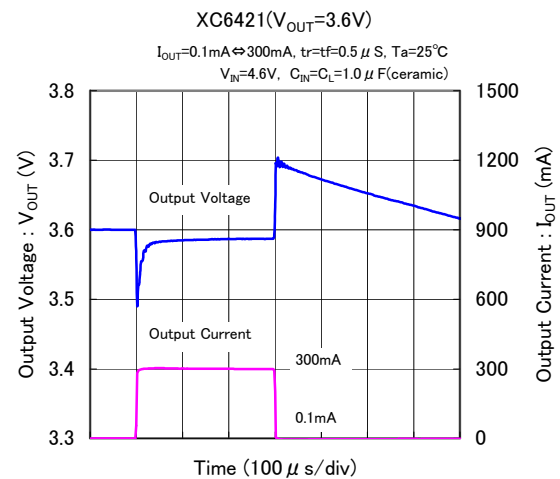
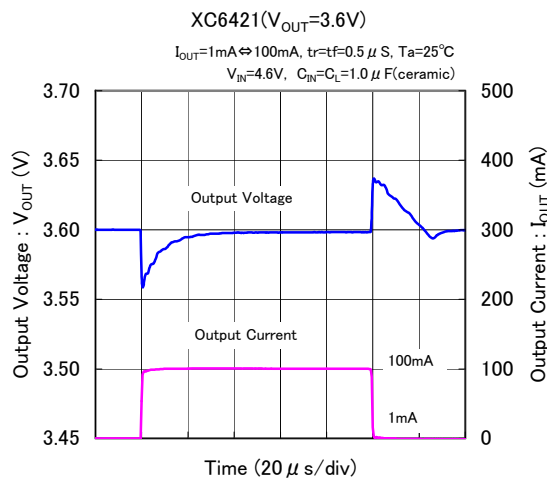
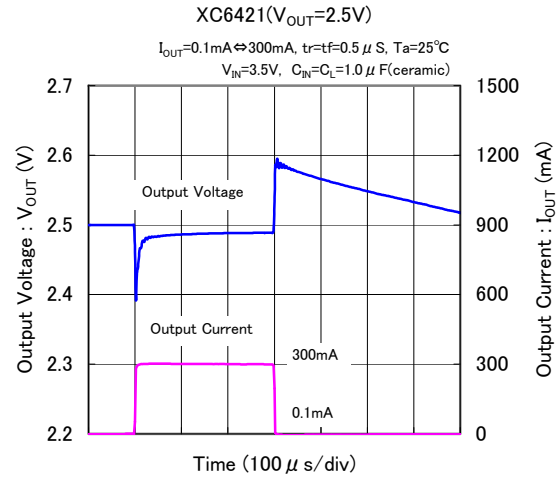
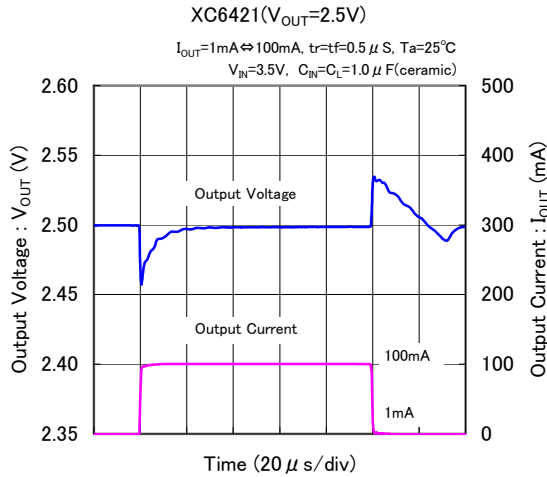

(11) EN Rising Respose Time

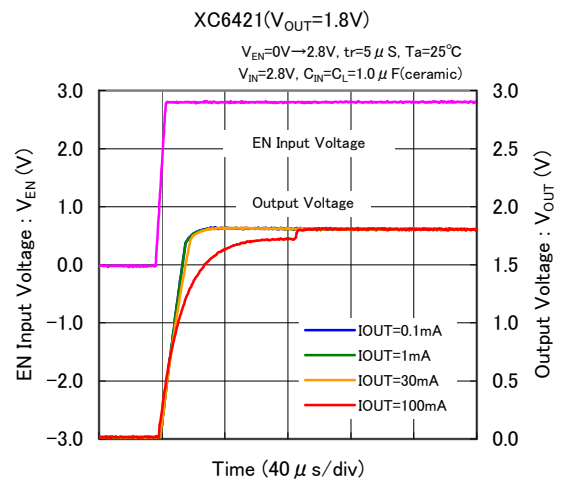
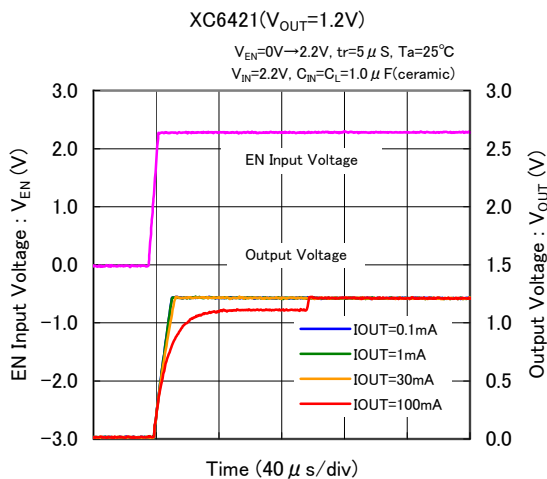

■ TYPICAL PERFORMANCE CHARACTERISTICS (Continued)

(11) EN Rising Response Time

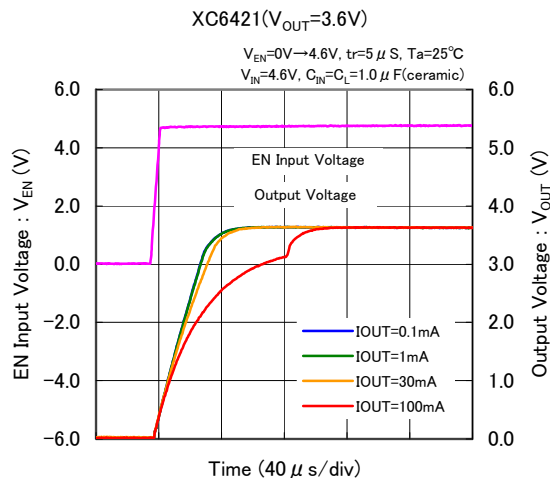
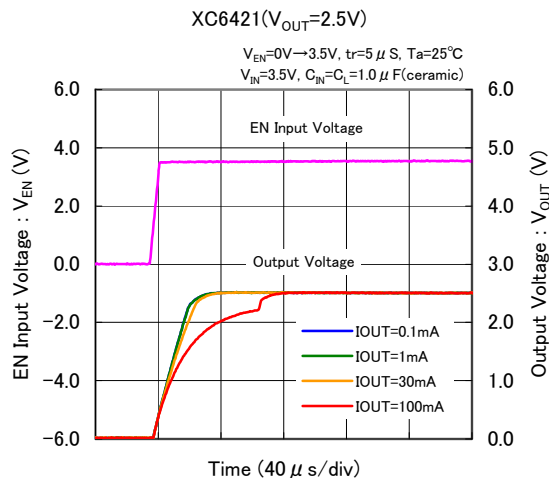

(12) Ripple Rejection Rate

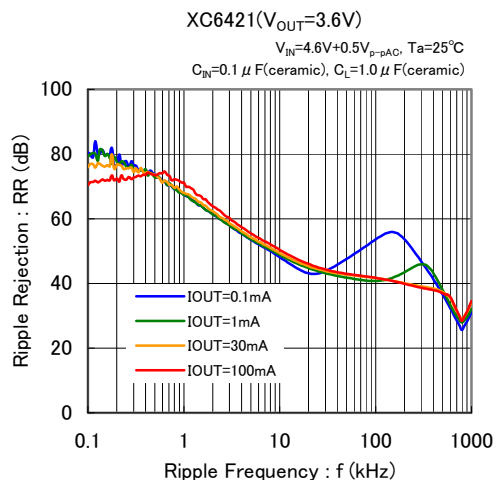
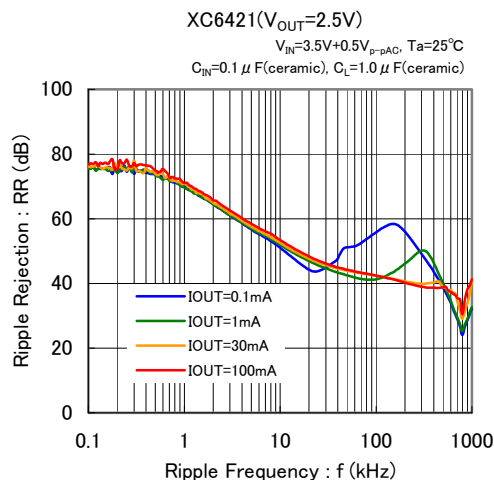
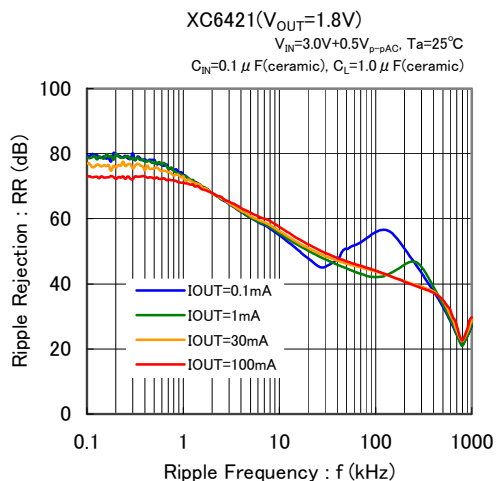
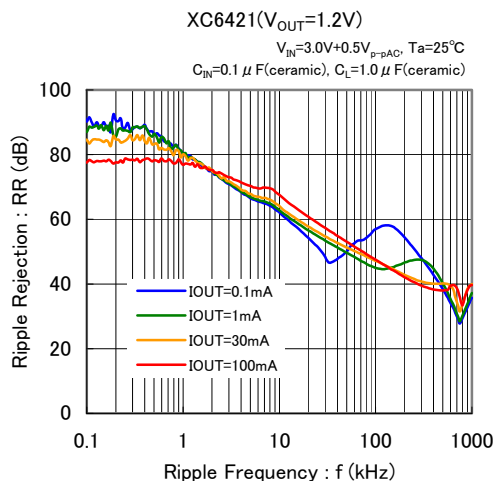

TYPICAL PERFORMANCE CHARACTERISTICS (Continued)

(13) Inrush Current Response

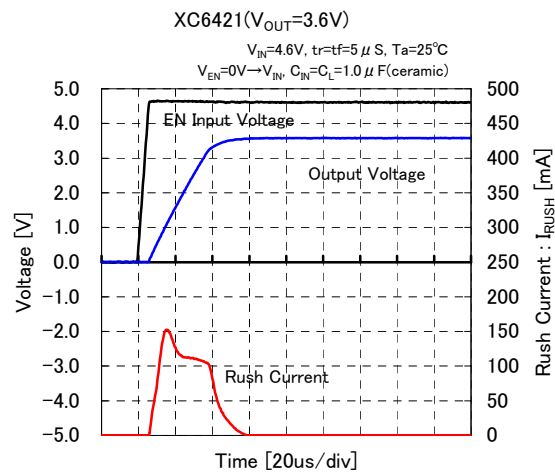
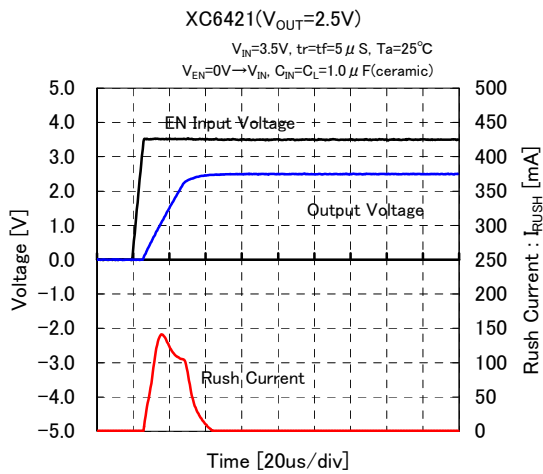
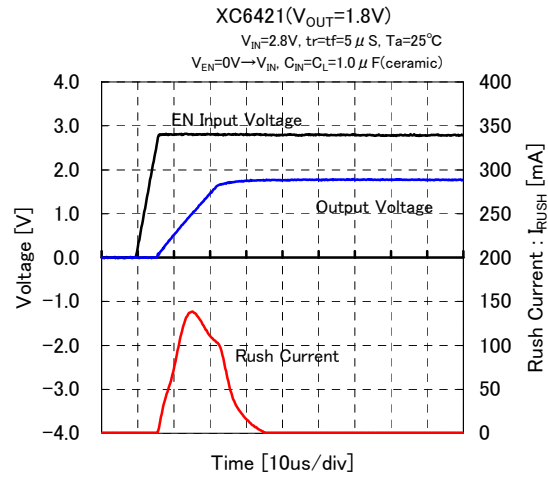
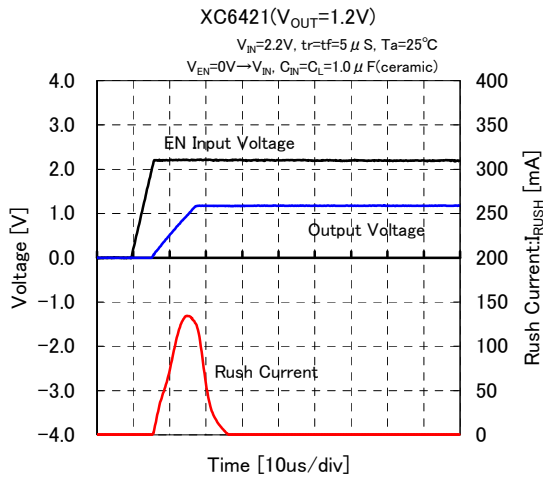

(14) Cross Talk

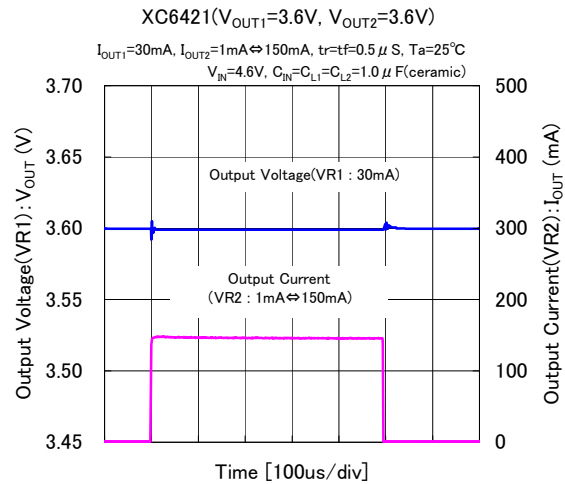
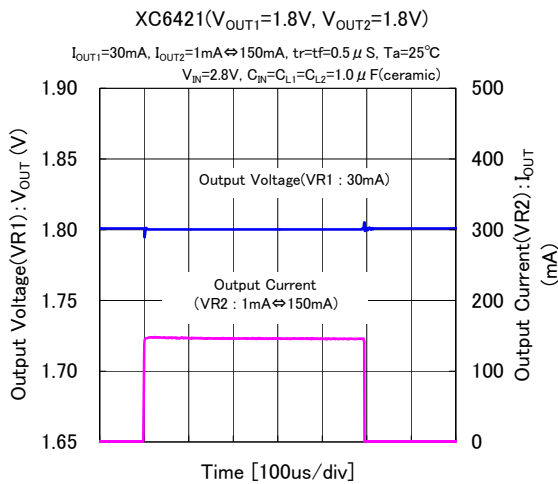

■ TYPICAL PERFORMANCE CHARACTERISTICS (Continued)

(15) Output Noise Density

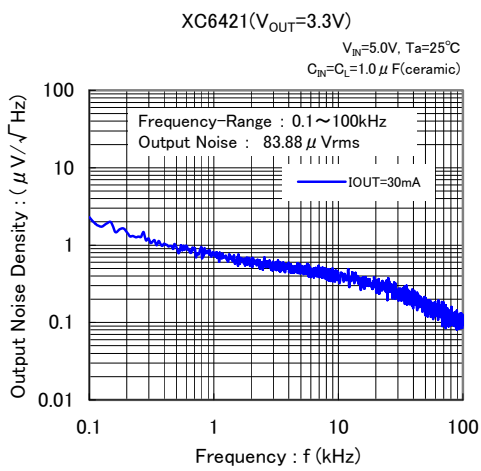
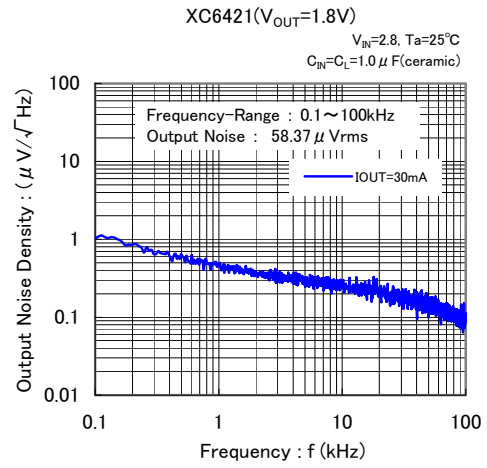
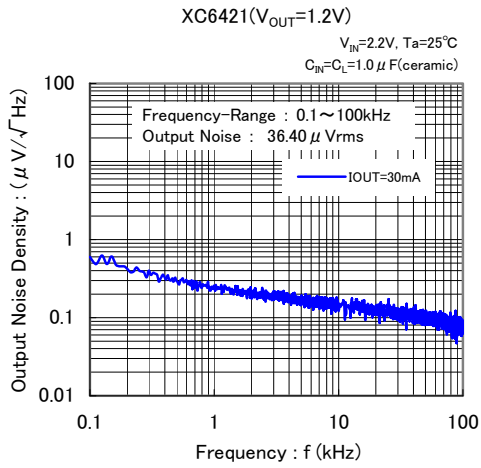

PACKAGING INFORMATION

● USP-6C

(unit : mm)

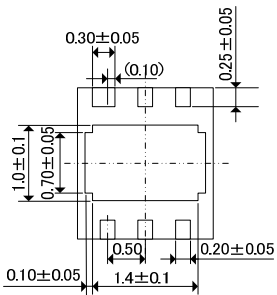
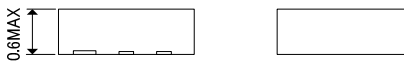
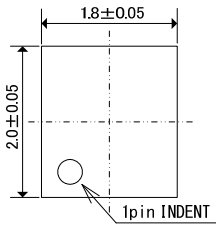

● USP-6C Reference Pattern Layout

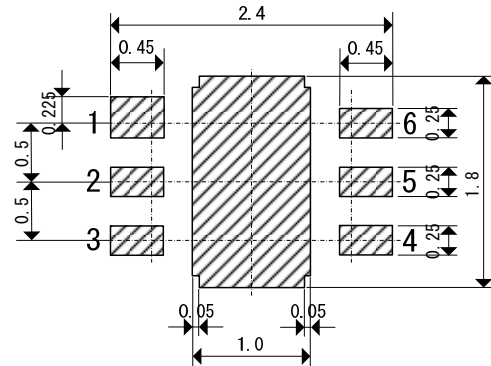

● USP-6C Reference Metal Mask Design

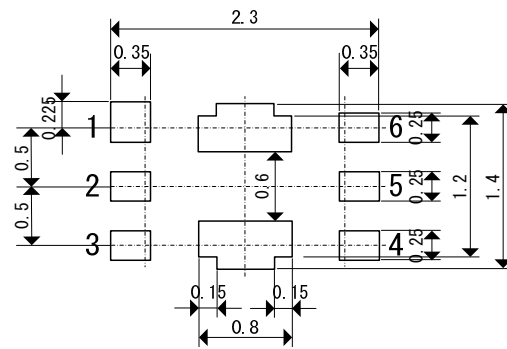

■ PACKAGING INFORMATION (Continued)

● USP-6C Power Dissipation (40mm x 40mm Standard board)

Power dissipation data for the USP-6C is shown in this page.
The value of power dissipation varies with the mount board conditions.
Please use this data as the reference data taken in the following condition.

1. Measurement Condition

- Condition : Mount on a board
- Ambient : Natural convection
- Soldering : Lead (Pb) free
- Board : Dimensions 40 x 40 mm
(1600 mm² in one side)
Copper (Cu) traces occupy 50% of the board area in top and back faces
Package heat-sink is tied to the copper traces
- Material : Glass Epoxy (FR-4)
- Thickness : 1.6mm
- through-hole : 4 x 0.8 Diameter

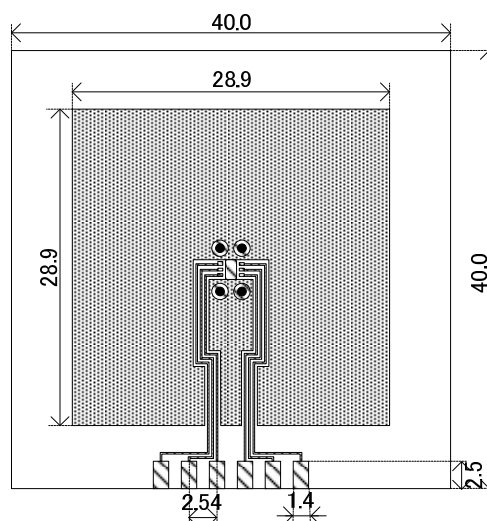

Evaluation Board (Unit : mm)

2. Power Dissipation vs. Ambient Temperature

Board Mount ($T_j \text{ max} = 125^\circ\text{C}$)

Ambient Temperature ($^\circ\text{C}$)	Power Dissipation P_d (mW)	Thermal Resistance ($^\circ\text{C}/\text{W}$)
25	1000	100.00
85	400	

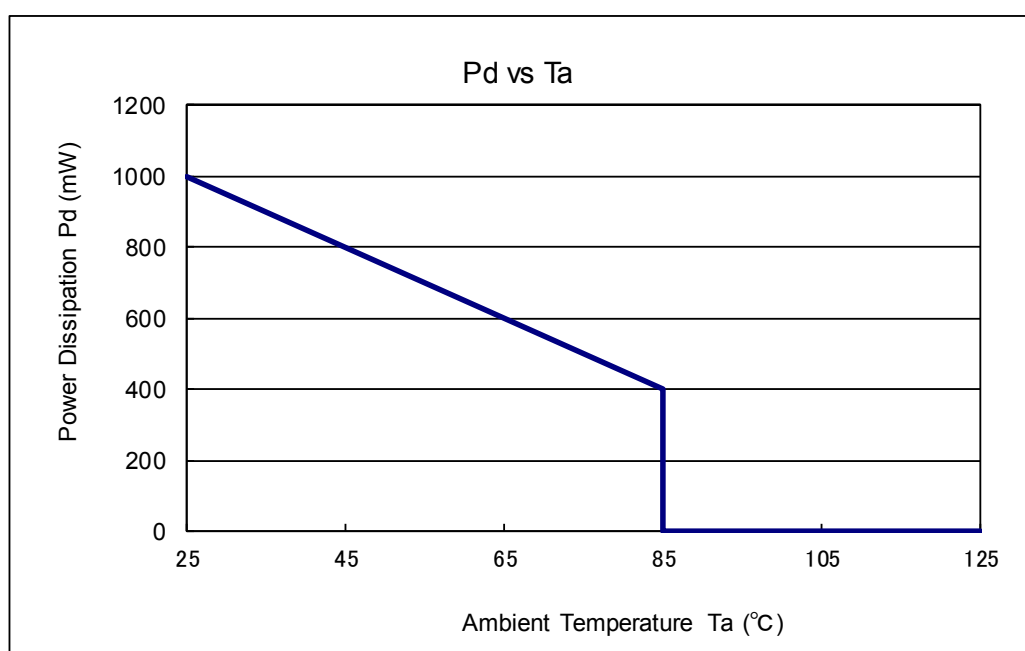

PACKAGING INFORMATION (Continued)

● USP-6C Power Dissipation (JEDEC board)

Power dissipation data for the USP-6C is shown in this page.

The value of power dissipation varies with the mount board conditions.

Please use this data as one of reference data taken in the described condition.

1. Measurement Condition (Reference data)

Condition : Mount on a board

Ambient : Natural convection

Soldering : Lead (Pb) free

Board : The board using 4 copper layer.

(76.2mm×114.3mm . . . Area: about 8700mm²)

1st layer : No copper foil (Signal layer)

2nd layer : 70mm×70mm_Connected to heat-sink.

3rd layer : 70mm×70mm_Connected to heat-sink.

4th layer : No copper foil (Signal layer)

Material : Glass Epoxy (FR-4)

Thickness : 1.6mm

Through-hole : φ0.2mm x 60pcs

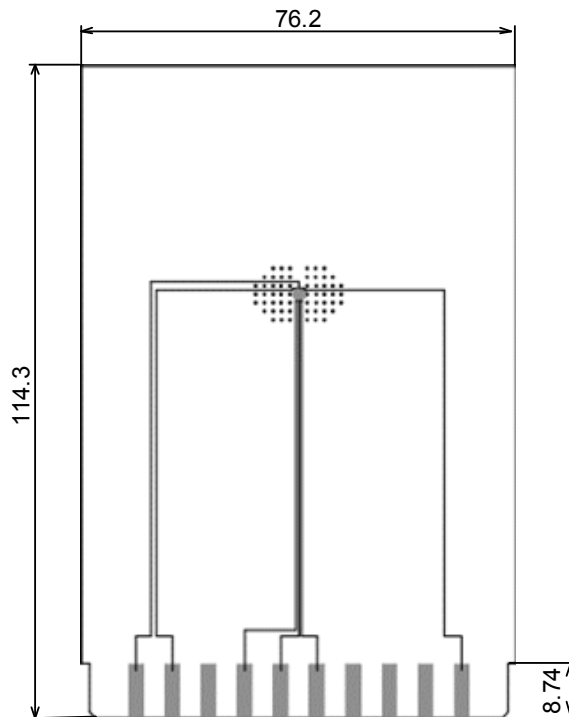

Evaluation Board (Unit: mm)

2. Power Dissipation vs. Ambient temperature

Board Mount($T_{jmax} = 125^{\circ}\text{C}$)

Ambient Temperature ($^{\circ}\text{C}$)	Power Dissipation Pd (mW)	θ_{ja} ($^{\circ}\text{C}/\text{W}$)
25	1250	80.00
85	500	

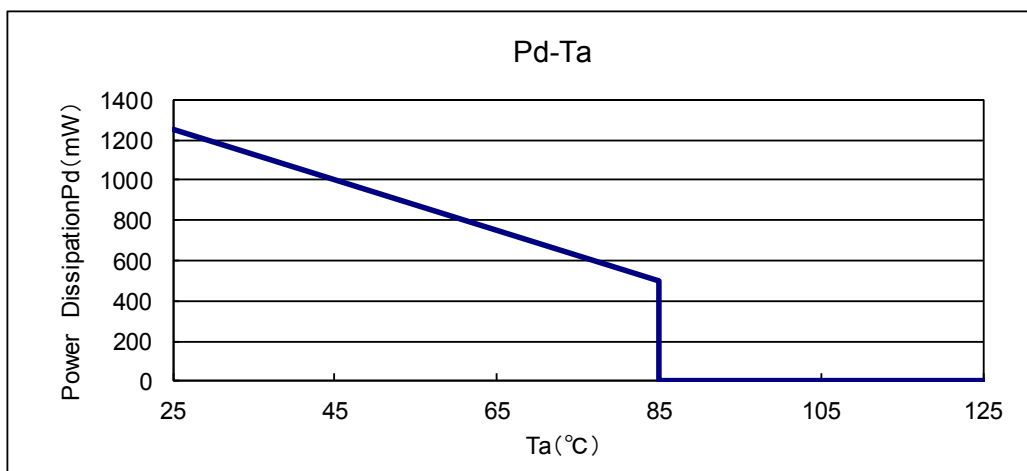

MARKING RULE

● USP-6C

① represents product series

MARK	PRODUCT SERIES
R	XC6421*****-G

②③ represents output voltage
ex.)

MARK		PRODUCT SERIES
②	③	
0	1	XC6421**01**-G

④⑤ represents production lot number
01 to 09, 0A to 0Z, 11 to 9Z, A1 to A9, AA to Z9, ZA to ZZ in order.
(G, I, J, O, Q, W excluded. No character inversion used.)

USP-6C

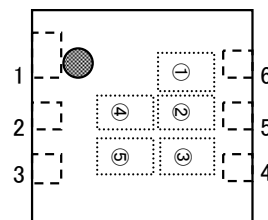

1. The product and product specifications contained herein are subject to change without notice to improve performance characteristics. Consult us, or our representatives before use, to confirm that the information in this datasheet is up to date.
2. The information in this datasheet is intended to illustrate the operation and characteristics of our products. We neither make warranties or representations with respect to the accuracy or completeness of the information contained in this datasheet nor grant any license to any intellectual property rights of ours or any third party concerning with the information in this datasheet.
3. Applicable export control laws and regulations should be complied and the procedures required by such laws and regulations should also be followed, when the product or any information contained in this datasheet is exported.
4. The product is neither intended nor warranted for use in equipment of systems which require extremely high levels of quality and/or reliability and/or a malfunction or failure which may cause loss of human life, bodily injury, serious property damage including but not limited to devices or equipment used in 1) nuclear facilities, 2) aerospace industry, 3) medical facilities, 4) automobile industry and other transportation industry and 5) safety devices and safety equipment to control combustions and explosions. Do not use the product for the above use unless agreed by us in writing in advance.
5. Although we make continuous efforts to improve the quality and reliability of our products; nevertheless Semiconductors are likely to fail with a certain probability. So in order to prevent personal injury and/or property damage resulting from such failure, customers are required to incorporate adequate safety measures in their designs, such as system fail safes, redundancy and fire prevention features.
6. Our products are not designed to be Radiation-resistant.
7. Please use the product listed in this datasheet within the specified ranges.
8. We assume no responsibility for damage or loss due to abnormal use.
9. All rights reserved. No part of this datasheet may be copied or reproduced unless agreed by Torex Semiconductor Ltd in writing in advance.

TOREX SEMICONDUCTOR LTD.

单击下面可查看定价，库存，交付和生命周期等信息

[>>Torex Semiconductor\(特瑞仕\)](#)