

PWM Controlled Step-Up DC/DC Controller

■ GENERAL DESCRIPTION

The XC9101 series are step-up multiple current and voltage feedback DC/DC controller ICs. Current sense, clock frequencies and amp feedback gain can all be externally regulated.

A stable power supply is possible with output currents of up to 1.5A.

With output voltage fixed internally, V_{OUT} is selectable in 0.1V increments within a 2.5V ~ 16.0V range ($\pm 2.5\%$).

For output voltages outside this range, we recommend the FB version, which has a 0.9V internal reference voltage. Using this version, the required output voltage can be set using 2 external resistors.

Switching frequency can also be set externally within a range of 100 ~ 600 kHz and therefore a frequency suited to your particular application can be selected.

With the current sense function, peak currents (which flow through the driver transistor and the coil) can be controlled. Soft-start time can be adjusted using external resistor and capacitor.

During shutdown (CE pin=L), consumption current can be reduced to as little as $0.5 \mu A$ (TYP.) or less.

■ APPLICATIONS

- E-book Reader / Electronic dictionaries
- Portable game consoles
- Mobile devices / terminals
- Digital still cameras / Camcorders
- Smart phones / Mobile phones
- Note PCs / Tablet PCs

■ FEATURES

Stable Operations via Current & Voltage

Multiple Feedback

Unlimited Options for Peripheral Selection

Current Protection Circuit

Ceramic Capacitor Compatible

Input Voltage Range : 2.5V ~ 20V

Output Voltage Range : 2.5V ~ 16V

(Fixed Voltage Type)

: 30V + (Adjustable Type)

Oscillation Frequency Range

: 100 kHz ~ 600kHz

Output Current : Up to 1.5A

Operating Ambient Temperature: $-40^{\circ}C \sim +85^{\circ}C$

Packages : MSOP-8A

Environmentally Friendly : EU RoHS Compliant, Pb Free

■ TYPICAL APPLICATION CIRCUIT

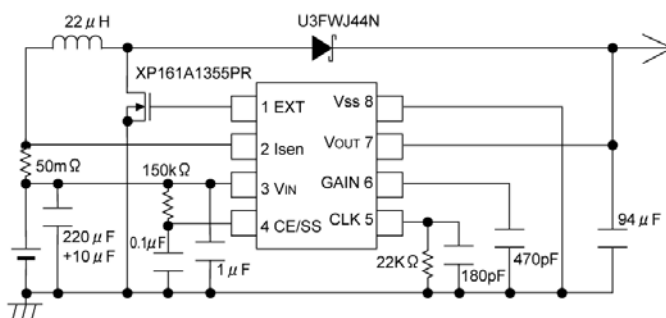

■ TYPICAL PERFORMANCE CHARACTERISTICS

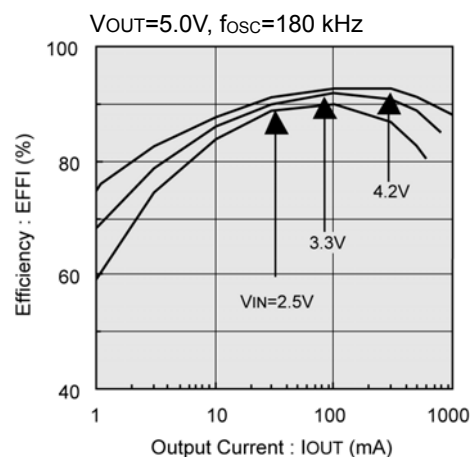

PIN CONFIGURATION

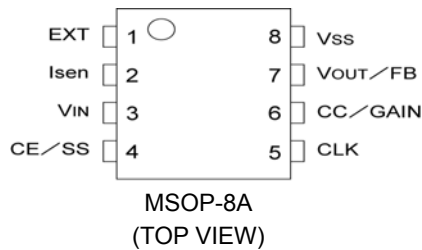

PIN ASSIGNMENT

| MSOP-8A | PIN NAME | FUNCTIONS |
|---------|----------|--------------------|
| 1 | EXT | Driver |
| 2 | ISEN | Current Sense |
| 3 | VIN | Power Input |
| 4 | CE/SS | CE/Soft Start |
| 5 | CLK | Clock Input |
| 6 | CC/GAIN | Phase Compensation |
| 7 | VOUT/FB | Voltage Sense |
| 8 | VSS | Ground |

PRODUCT CLASSIFICATION

Ordering Information

XC9101①②③④⑤⑥-⑦^(*)

| DESIGNATOR | ITEM | SYMBOL | DESCRIPTION |
|------------|---------------------------|---------|---|
| ① | Type of DC/DC Controllers | C | VOUT (Fixed voltage type), Soft-start externally set-up |
| | | D | FB (Voltage adjustable), Soft-start externally set-up |
| ② ③ | Output Voltage | 25 ~ H0 | e.g. VOUT=2.5V → ②=2, ③=5 FB products → ②=0, ③=9 fixed Voltages above 10V → 10=A, 11=B, 12=C, 13=D, 14=E, 15=F, 16=H e.g. VOUT=13.5V → ②=D, ③=5 |
| | | 09 | FB products → ②=0, ③=9 fixed |
| ④ | Oscillation Frequency | A | Frequency adjustable |
| ⑤⑥-⑦ | Package (Order Unit) | KR | MSOP-8A (1,000/Reel) |
| | | KR-G | MSOP-8A (1,000/Reel) |

^(*) The “-G” suffix denotes Halogen and Antimony free as well as being fully EU RoHS compliant.

The standard output voltages of the XC9101C series are 2.5V, 3.3V, and 5.0V.

Voltages other than those listed are semi-custom.

■ BLOCK DIAGRAM

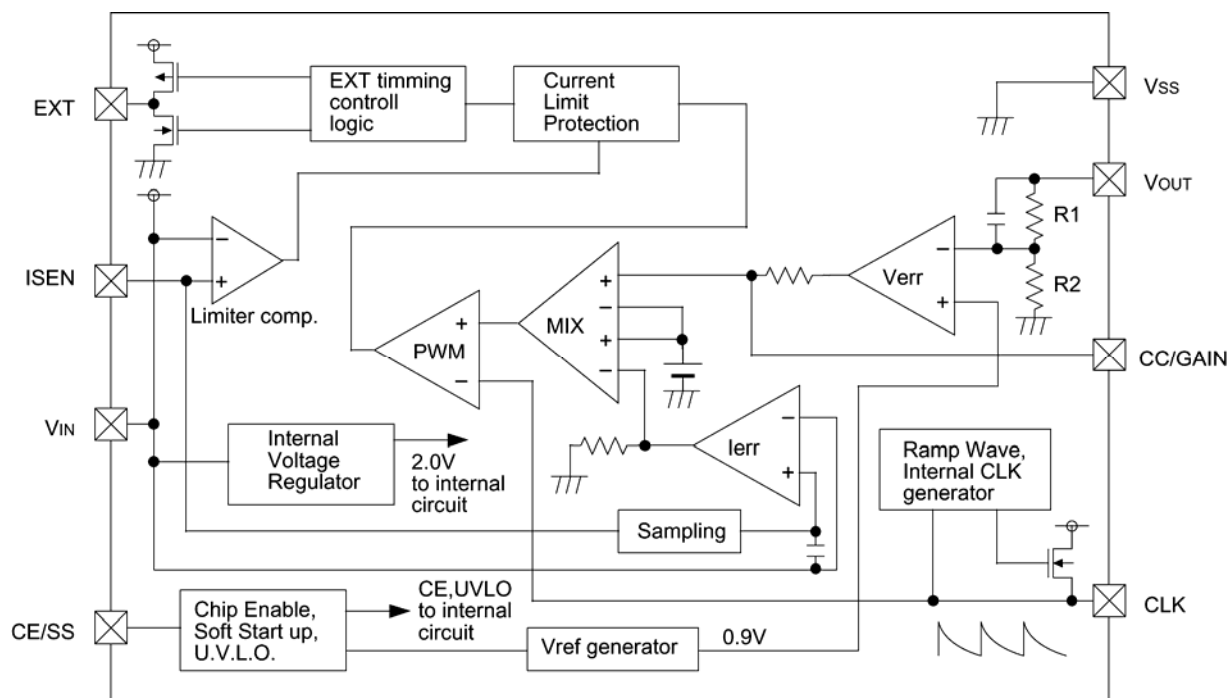

■ ABSOLUTE MAXIMUM RATINGS

Ta = 25°C

| PARAMETER | SYMBOL | RATINGS | UNITS |
|----------------------------------|----------------------|---------------------------|-------|
| EXT Pin Voltage | V _{EXT} | -0.3~V _{IN} +0.3 | V |
| I _{SEN} Pin Voltage | V _{ISEN} | -0.3~+22 | V |
| V _{IN} Pin Voltage | V _{IN} | -0.3~+22 | V |
| CE/SS Pin Voltage | V _{CE} | -0.3~+22 | V |
| CLK Pin Voltage | V _{CLK} | -0.3~V _{IN} +0.3 | V |
| CC/GAIN Pin Voltage | V _{CC} | -0.3~V _{IN} +0.3 | V |
| V _{OUT} /FB Pin Voltage | V _{OUT} /FB | -0.3~+22 | V |
| EXT Pin Current | I _{EXT} | ±100 | mA |
| Power Dissipation | P _d | 150 | mW |
| Operating Ambient Temperature | T _{opr} | -40~+85 | °C |
| Storage Temperature | T _{stg} | -55~+125 | °C |

ELECTRICAL CHARACTERISTICS

XC9101C33AKR

Ta=25°C

| PARAMETER | SYMBOL | CONDITIONS | MIN. | TYP. | MAX. | UNITS | CIRCUITS |
|-----------------------------------|---|--|-------|-------|-------|-------|----------|
| Output Voltage | V _{OUT} | I _{OUT} =300mA | 3.218 | 3.300 | 3.382 | V | ① |
| Maximum Operating Voltage | V _{INmax} | | 20 | — | — | V | ① |
| Minimum Operating Voltage | V _{INmin} | | — | — | 2.5 | V | ① |
| Supply Current 1 | I _{DD1} | V _{IN} =2.5V, V _{OUT} =CE=Setting Output Voltage×0.95V | — | 150 | 255 | μA | ② |
| Supply Current 2 | I _{DD2} | V _{IN} =2.5V, CE=V _{IN} V _{OUT} =Setting Output Voltage×1.05V | — | 90 | 176 | μA | ② |
| Stand-by Current | I _{STB} | V _{IN} =2.5V, CE=V _{OUT} =V _{SS} | | 0.5 | 2.0 | μA | ② |
| CLK Oscillation Frequency | f _{OSC} | R _T =10.0kΩ, C _T =220pF | 280 | 330 | 380 | kHz | ③ |
| Frequency Line Regulation | $\frac{\Delta f_{OSC}}{\Delta V_{IN} \cdot f_{OSC}}$ | V _{IN} =2.5V ~ 20V | — | ±5 | — | % | ③ |
| Frequency Temperature Fluctuation | $\frac{\Delta f_{OSC}}{\Delta T_{opr} \cdot f_{OSC}}$ | V _{IN} =2.5V T _{opr} =-40 ~ +85°C | — | ±5 | — | % | ③ |
| Maximum Duty Cycle | D _{MAX} | V _{OUT} =Set Voltage×0.95V | 79 | 85 | 89 | % | ④ |
| Minimum Duty Cycle | D _{MIN} | V _{OUT} =Set Voltage×1.05V | — | — | 0 | % | ④ |
| Current Limit Voltage | I _{LIM} | V _{IN} pin voltage – I _{SEN} pin voltage | 90 | 150 | 220 | mV | ⑥ |
| I _{SEN} Current | I _{ISEN} | V _{IN} =2.5V, I _{SEN} =2.5V | 4.5 | 7 | 13 | μA | ⑥ |
| CE "High" Current | I _{CEH} | CE=V _{IN} =2.5V, V _{OUT} =0V | -0.1 | 0 | 0.1 | μA | ⑤ |
| CE "Low" Current | I _{CEL} | CE=0V, V _{IN} =2.5V, V _{OUT} =0V | -0.1 | 0 | 0.1 | μA | ⑤ |
| CE "High" Voltage | V _{CEH} | CLK Oscillation Starts, V _{OUT} =0V, CE: Voltage applied | 0.6 | — | — | V | ⑤ |
| CE "Low" Voltage | V _{CEL} | CLK Oscillation Stops, V _{OUT} =0V, CE: Voltage applied | — | — | 0.2 | V | ⑤ |
| EXT "High" ON Resistance | R _{EXTH} | EXT=V _{IN} –0.4V, CE=V _{IN} =2.5V V _{OUT} =Setting voltage×0.95V | — | 31 | 58 | Ω | ④ |
| EXT "Low" ON Resistance | R _{EXTL} | EXT=0.4V, CE=V _{IN} =2.5V V _{OUT} =Setting voltage×1.05 | — | 27 | 45 | Ω | ④ |
| Efficiency (*1) | EFFI | | — | 88 | — | % | ① |
| Soft-Start Time | t _{SS} | Connect C _{SS} and R _{SS} , CE : 0V→2.5V | 5 | 10 | 20 | ms | ① |
| CC/GAIN Pin Output Impedance | R _{CCGAIN} | | — | 400 | — | kΩ | ⑦ |

Unless otherwise stated, V_{IN} = 2.5V

NOTE:

*1: EFFI = [(output voltage) × (output current)] ÷ [(input voltage) × (input current)] × 100

*2: The capacity range of the capacitor used to set the external CLK frequency is 150 ~ 220pF

■ ELECTRICAL CHARACTERISTICS (Continued)

XC9101C50AKR

Ta=25°C

| PARAMETER | SYMBOL | CONDITIONS | MIN. | TYP. | MAX. | UNITS | CIRCUITS |
|-----------------------------------|---|--|-------|-------|-------|-------|----------|
| Output Voltage | V _{OUT} | I _{OUT} =300mA | 4.875 | 5.000 | 5.125 | V | ① |
| Maximum Operating Voltage | V _{INMAX} | | 20 | — | — | V | ① |
| Minimum Operating Voltage | V _{INMIN} | | — | — | 2.5 | V | ① |
| Supply Current 1 | I _{DD1} | V _{IN} =3.0V, V _{OUT} =CE=Setting Output Voltage×0.95V | — | 160 | 270 | μA | ② |
| Supply Current 2 | I _{DD2} | V _{IN} =3.0V, CE=V _{IN} V _{OUT} =Setting Output Voltage×1.05V | — | 90 | 176 | μA | ② |
| Stand-by Current | I _{STB} | V _{IN} =3.0V, CE=V _{OUT} =V _{SS} | — | 0.5 | 2.0 | μA | ② |
| CLK Oscillation Frequency | f _{OSC} | R _T =10.0kΩ, C _T =220pF | 280 | 330 | 380 | kHz | ③ |
| Frequency Line Regulation | $\frac{\Delta f_{OSC}}{\Delta V_{IN} \cdot f_{OSC}}$ | V _{IN} =2.5V~20V | — | ±5 | — | % | ③ |
| Frequency Temperature Fluctuation | $\frac{\Delta f_{OSC}}{\Delta T_{opr} \cdot f_{OSC}}$ | V _{IN} =2.5V T _{opr} =-40~+85°C | — | ±5 | — | % | ③ |
| Maximum Duty Cycle | D _{MAX} | V _{OUT} =Setting Voltage×0.95V | 79 | 85 | 89 | % | ④ |
| Minimum Duty Cycle | D _{MIN} | V _{OUT} =Setting Voltage×1.05V | — | — | 0 | % | ④ |
| Current Limit Voltage | I _{LIM} | V _{IN} pin voltage – I _{SEN} pin voltage | 90 | 150 | 220 | mV | ⑥ |
| I _{SEN} Current | I _{ISEN} | V _{IN} =3.0V, I _{SEN} =3.0V | 4.5 | 7 | 13 | μA | ⑥ |
| CE "High" Current | I _{CEH} | CE=V _{IN} =3.0V, V _{OUT} =0V | -0.1 | 0 | 0.1 | μA | ⑤ |
| CE "Low" Current | I _{CEL} | CE=0V, V _{IN} =3.0V, V _{OUT} =0V | -0.1 | 0 | 0.1 | μA | ⑤ |
| CE "High" Voltage | V _{CEH} | CLK Oscillation Starts, V _{OUT} =0V, CE: Voltage applied | 0.6 | — | — | V | ⑤ |
| CE "Low" Voltage | V _{CEL} | CLK Oscillation Stops, V _{OUT} =0V, CE: Voltage applied | — | — | 0.2 | V | ⑤ |
| EXT "High" ON Resistance | R _{EXTH} | EXT=V _{IN} –0.4V, CE=V _{IN} =3.0V V _{OUT} =Setting voltage×0.95V | — | 27 | 51 | Ω | ④ |
| EXT "Low" ON Resistance | R _{EXTL} | EXT=0.4V, CE=V _{IN} =3.0V V _{OUT} =Setting voltage×1.05V | — | 25 | 37 | Ω | ④ |
| Efficiency (*1) | EFFI | | — | 87 | — | % | ① |
| Soft-Start Time | t _{SS} | Connect C _{SS} and R _{SS} , CE: 0V→3.0V | — | 5 | — | ms | ① |
| CC/GAIN Pin Output Impedance | R _{CCGAIN} | | — | 400 | — | kΩ | ⑦ |

NOTE: Unless otherwise stated, V_{IN} = 3.0V.

*1: EFFI = {[output voltage] × [output current]} ÷ {[input voltage] × [input current]} × 100

*2: The capacity range of the capacitor used to set the external CLK frequency is 150 ~ 220pF

ELECTRICAL CHARACTERISTICS (Continued)

XC9101D09AKR

Ta=25°C

| PARAMETER | SYMBOL | CONDITIONS | MIN. | TYP. | MAX. | UNITS | CIRCUITS |
|-----------------------------------|---|--|--------|------|--------|-------|----------|
| Output Voltage | V _{OUT} | I _{OUT} =300mA | 0.8775 | 0.9 | 0.9225 | V | ① |
| Maximum Operating Voltage | V _{INMAX} | | 20 | — | — | V | ① |
| Minimum Operating Voltage | V _{INMIN} | | — | — | 2.5 | V | ① |
| Supply Current 1 | I _{DD1} | V _{IN} =2.5V, V _{IN} =CE, FB=0.9×0.95V | — | 150 | 255 | μA | ② |
| Supply Current 2 | I _{DD2} | V _{IN} =2.5V, CE=V _{IN} , V _{OUT} =0.9×1.05V | — | 90 | 176 | μA | ② |
| Stand-by Current | I _{STB} | V _{IN} =2.5V, CE=FB=V _{SS} | — | 0.5 | 2.0 | μA | ② |
| CLK Oscillation Frequency | f _{OSC} | R _T =10.0kΩ, C _T =220pF | 280 | 330 | 380 | kHz | ③ |
| Frequency Line Regulation | $\frac{\Delta f_{OSC}}{\Delta V_{IN} \cdot f_{OSC}}$ | V _{IN} =2.5V~20V | — | ±5 | — | % | ③ |
| Frequency Temperature Fluctuation | $\frac{\Delta f_{OSC}}{\Delta T_{opr} \cdot f_{OSC}}$ | V _{IN} =2.5V T _{opr} =-40~+85°C | — | ±5 | — | % | ③ |
| Maximum Duty Cycle | D _{MAX} | V _{OUT} =0.9×0.95V | 79 | 85 | 89 | % | ④ |
| Minimum Duty Cycle | D _{MIN} | V _{OUT} =0.9×1.05V | | | 0 | % | ④ |
| Current Limiter Voltage | I _{LIM} | V _{IN} pin voltage — I _{SEN} pin voltage | 90 | 150 | 220 | mV | ⑥ |
| I _{SEN} Current | I _{ISEN} | V _{IN} =2.5V, I _{SEN} =2.5V | 4.5 | 7 | 13 | μA | ⑥ |
| CE "High" Current | I _{CEH} | CE=V _{IN} =2.5V, FB=0V | -0.1 | 0 | 0.1 | μA | ⑤ |
| CE "Low" Current | I _{CEL} | CE=0V, V _{IN} =2.5V, FB=0V | -0.1 | 0 | 0.1 | μA | ⑤ |
| CE "High" Voltage | V _{CEH} | CLK Oscillation Start, FB=0V, CE: Voltage applied | 0.6 | — | — | V | ⑤ |
| CE "Low" Voltage | V _{CEL} | CLK Oscillation Stop, FB=0V, CE: Voltage applied | — | — | 0.2 | V | ⑤ |
| EXT "High" ON Resistance | R _{EXTH} | EXT=V _{IN} -0.4V, CE=V _{IN} V _{OUT} =Setting voltage×0.95V | — | 31 | 58 | Ω | ④ |
| EXT "Low" ON Resistance | R _{EXTL} | EXT=0.4V, CE=V _{IN} V _{OUT} =Setting voltage×1.05V | — | 27 | 45 | Ω | ④ |
| Efficiency (*1) | EFFI | | — | 88 | — | % | ① |
| Soft-Start Time | t _{SS} | Connect C _{SS} and R _{SS} , CE : 0V→2.5V | 5 | 10 | 20 | ms | ① |
| CC/GAIN Pin Output Impedance | R _{CCGAIN} | | — | 400 | — | kΩ | ⑦ |

NOTE: Unless otherwise stated, V_{IN} = 2.5V

External Components: R_{FB1}=200kΩ, R_{FB2}=100kΩ, C_{FB}=82pF

*1: EFFI = $\frac{[(\text{output voltage}) \times (\text{output current})]}{[(\text{input voltage}) \times (\text{input current})]} \times 100$

*2: The capacity range of the capacitor used to set the external CLK frequency is 150 ~ 220pF.

TYPICAL APPLICATION CIRCUITS

XC9101C33AKR

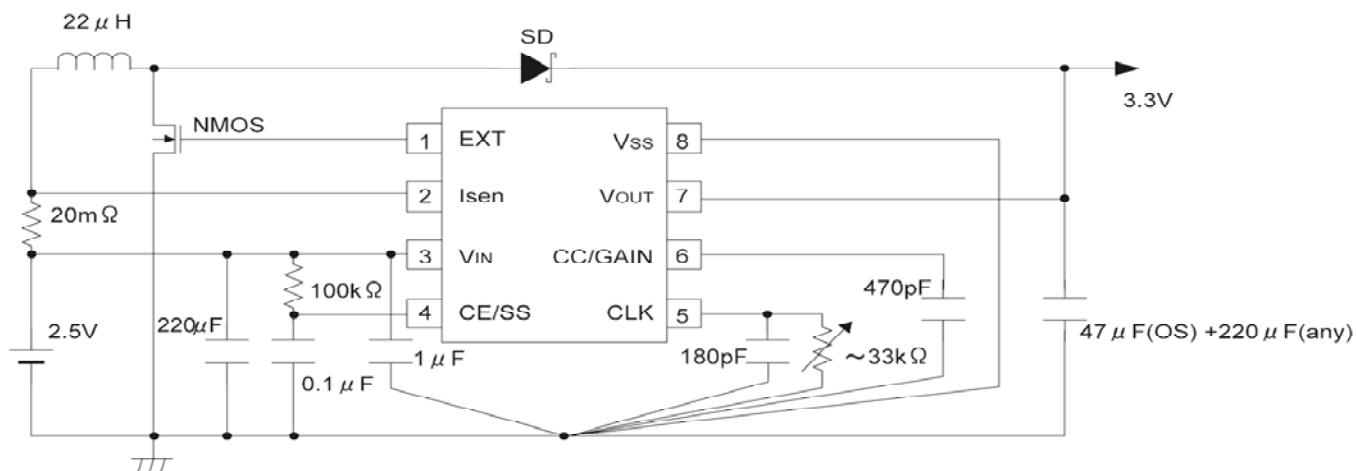

- NMOS : XP161A1355PR
 Coil : 22 μ H (CR105 SUMIDA)
 Resistor : 20m Ω for ISEN (NPR1 KOA), 33k Ω (trimmer) for CLK, 100k Ω for SS
 Capacitors : 180pF (ceramic) for CLK, 470pF (ceramic) for CC/GAIN, 0.1 μ F (ceramic) for SS, 1 μ F (ceramic) for Bypass
 47 μ F (OS)+220 μ F (any) for CL, 220 μ F (any) for CIN
 SD : U3FWJ44N (TOSHIBA)

XC9101C50AKR

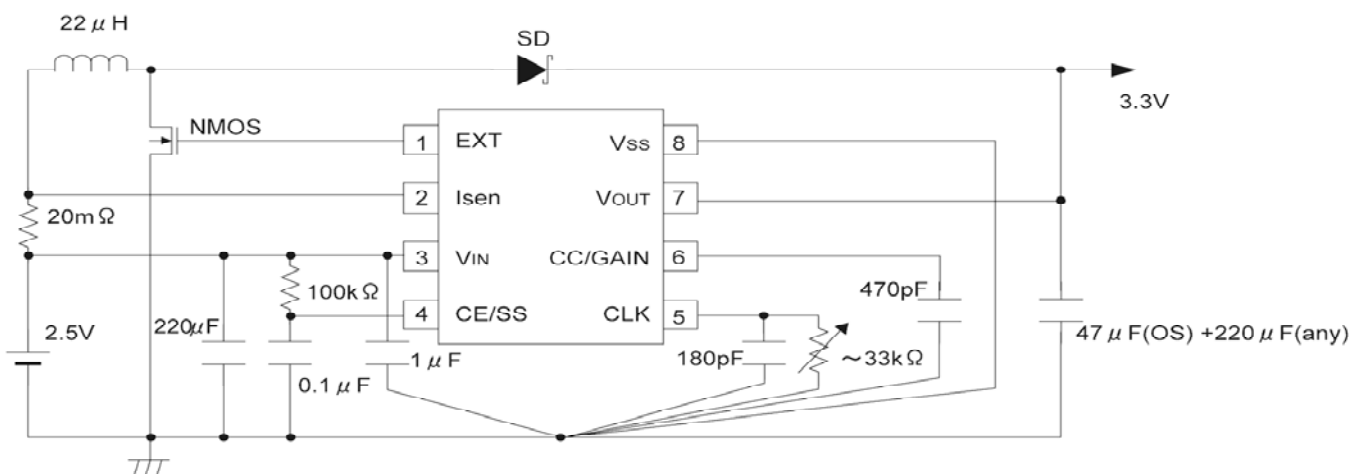

- NMOS : XP161A1355PR
 Coil : 22 μ H (CR105 SUMIDA)
 Resistor : 20m Ω for ISEN (NPR1 KOA), 33k Ω (trimmer) for CLK, 100k Ω for SS
 Capacitors : 180pF (ceramic) for CLK, 470pF (ceramic) for CC/GAIN, 0.1 μ F (ceramic) for SS, 1 μ F (ceramic) for Bypass
 47 μ F (OS)+220 μ F (any) for CL, 220 μ F (any) for CIN
 SD : U3FWJ44N (TOSHIBA)

TYPICAL APPLICATION CIRCUITS (Continued)

XC9101D09AKR

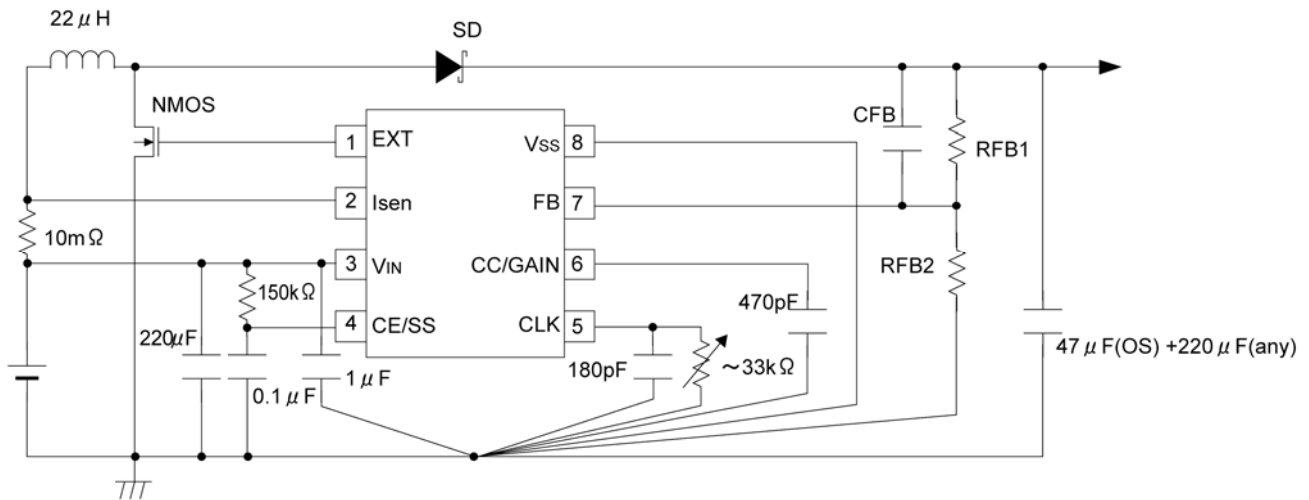

| | |
|------------------|---|
| NMOS | : XP161A11A1PR |
| Coil | : 22 μ H (CDRH127 SUMIDA) |
| Resistor | : 10m Ω for ISEN (NPR1 KOA), 33k Ω (trimmer) for CLK, 150k Ω for SS |
| Capacitors | : 180pF (ceramic) for CLK, 470pF (ceramic) for CC/GAIN, 0.1 μ F (ceramic) for SS, 1 μ F (ceramic) for Bypass 47 μ F (OS)+220 μ F (any) for CL, 220 μ F (any) for C _{IN} |
| SD | : U5FWJ44N (TOSHIBA) |
| V _{OUT} | : 16V |
| RFB1 | : 560k Ω |
| RFB2 | : 33k Ω |
| CFB | : 27pF |
| V _{OUT} | : 20V |
| RFB1 | : 470k Ω |
| RFB2 | : 22k Ω |
| CFB | : 33pF |

■ OPERATIONAL EXPLANATION

Step-up DC/DC converter controllers of the XC9101 series carry out pulse width modulation (PWM) according to the multiple feedback signals of the output voltage and coil current. The internal circuits consist of different blocks that operate at V_{IN} or the stabilized power (2.0 V) of the internal regulator. The fixed output voltage of the C type and the FB pin voltage ($V_{ref} = 0.9\text{ V}$) of type D controller have been adjusted and set by laser-trimming.

<Clock>

With regard to clock pulses, a capacitor and resistor connected to the CLK pin generate ramp waveforms whose top and bottom are 0.7V and 0.15V, respectively. The frequency can be set within a range of 100kHz to 600kHz externally (refer to the "Functional Settings" section for further information). The clock pulses are processed to generate a signal used for synchronizing internal sequence circuits.

<Verr amplifier>

The Verr amplifier is designed to monitor the output voltage. A fraction of the voltage applied to internal resistors R1, R2 in the case of a type C controller, and the voltage at the FB pin in the case of a type D controller, are fed back and compared with the reference voltage. In response to feedback of a voltage lower than the reference voltage, the output voltage of the Verr amplifier increases. The output of the Verr amplifier enters the mixer via resistor (R_{Verr}). This signal works as a pulse width control signal during PWM operations. By connecting an external capacitor and resistor through the CE/GAIN pin, it is possible to set the gain and frequency characteristics of Verr amplifier signals (refer to the "Functional Settings" section for further information).

<lerr amplifier>

The lerr amplifier monitors the coil current. The potential difference between the V_{IN} and Isen pins is sampled at each switching operation. Then the potential difference is amplified or held, as necessary, and input to the mixer. The lerr amplifier outputs a signal ensuring that the greater the potential difference between the V_{IN} and ISEN pins, the smaller the switching current. The gain and frequency characteristics of this amplifier are fixed internally.

<Mixer and PWM>

The mixer modulates the signal sent from Verr by the signal from lerr. The modulated signal enters the PWM comparator for comparison with the sawtooth pulses generated at the CLK pin. If the signal is greater than the sawtooth waveforms, a signal is sent to the output circuit to turn on the external switch.

<Current Limiter>

The current flowing through the coil is monitored by the limiter comparator via the V_{IN} and ISEN pins. The limiter comparator outputs a signal when the potential difference between the V_{IN} and ISEN pins reaches about 150 mV or more. This signal is converted to a logic signal and handled as a DFF reset signal for the internal limiter circuit. When a reset signal is input, a signal is output immediately at the EXT pin to turn off the MOS switch. When the limiter comparator sends a signal to enable data acceptance, a signal to turn on the MOS switch is output at the next clock pulse. If at this time the potential difference between the V_{IN} and ISEN pins is large, operation is repeated to turn off the MOS switch again. DFF operates in synchronization with the clock signal of the CLK pin.

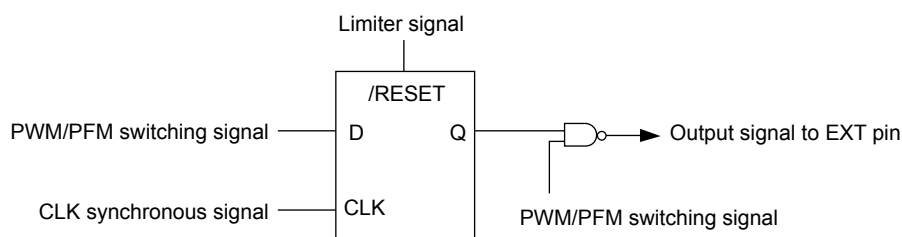

<Soft Start>

The soft start function is made available by attaching a capacitor and resistor to the CE/SS pin. The V_{ref} voltage applied to the Verr amplifier is restricted by the start-up voltage of the CE/SS pin. This ensures that the Verr amplifier operates with its two inputs in balance, thereby preventing the ON-TIME signal from becoming stronger than necessary. Consequently, soft start time needs to be set sufficiently longer than the time set to CLK. The start-up time of the CE/SS pin equals the time set for soft start (refer to the "Functional Settings" section for further information). The soft start function operates when the voltage at the CE/SS pin is between 0V to 1.55V. If the voltage at the CE/SS pin doesn't start from 0V but from a mid level voltage when the power is switched on, the soft start function become ineffective and large in-rush currents and ripple voltages may happen to create.

OPERATIONAL EXPLANATION (Continued)

Functional Settings

1. Soft Start

CE and soft start (SS) functions are commonly assigned to the CE/SS pin. The soft start function is effective until the voltage at the CE pin reaches approximately 1.55 V rising from 0 V. Soft start time is approximated by the equation below according to values of V_{cont} , R_{ss} , and C_{ss} .

$$T = -C_{ss} \times R_{ss} \times \ln((V_{cont} - 1.55) / V_{cont})$$

Example: When $C_{ss} = 0.1 \mu\text{F}$, $R_{ss} = 470 \text{ k}\Omega$, and $V_{cont} = 5 \text{ V}$,
 $T = -0.1 \times 10^{-6} \times 470 \times 10^3 \times \ln((5 - 1.55) / 5) = 17.44 \text{ ms}$.

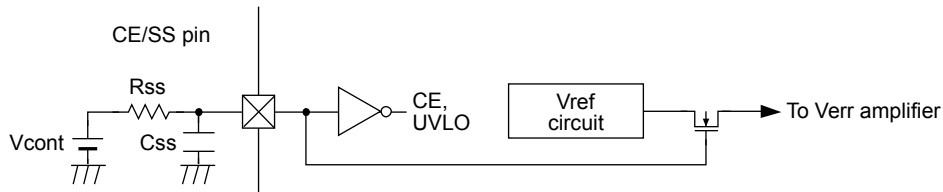

Set the soft start time to a value sufficiently longer than the period of a clock pulse.

> Circuit example 1: N-ch open drain

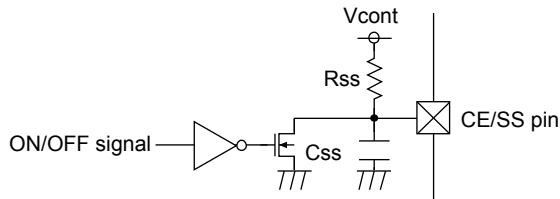

> Circuit example 2: CMOS logic (low supply current)

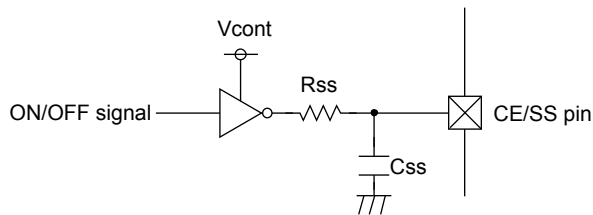

> Circuit example 3: CMOS logic (low supply current), quick off

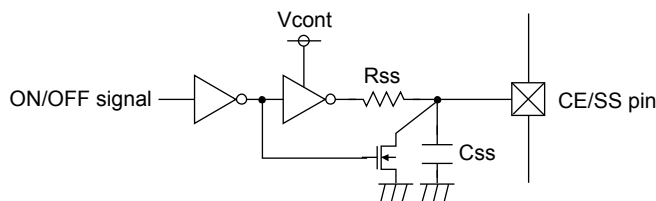

■ OPERATIONAL EXPLANATION (Continued)

● Functional Settings (Continued)

2. Oscillation Frequency

The oscillation frequency of the internal clock generator is approximated by the following equation according to the values of the capacitor and resistor attached to the CLK pin. To stabilize the IC's operation, set the oscillation frequency within a range of 100kHz to 600kHz. Select a value for Cclk within a range of 150pF to 220pF and fix the frequency based on the value for Rclk.

$$f = 1/(-Cclk \times Rclk \times \ln 0.26)$$

Example: When Cclk = 220 pF and Rclk = 10 kΩ, $f = 1 / (-220 \times 10^{-12} \times 10 \times 10^3 \times \ln(0.26)) = 337.43 \text{ kHz}$.

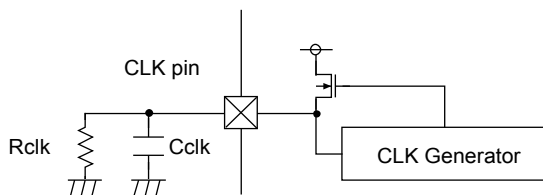

3. Gain and Frequency Characteristics of the Verr Amplifier

The gain at output and frequency characteristics of the Verr amplifier are adjusted by the values of the capacitor and resistor attached to the CC/GAIN pin. It is generally recommended to attach a CC of 220 to 1,000pF without RGAIN. The greater the CC value, the more stable the phase and the slower the transient response. When using the IC with RGAIN connected, it should be noted that if the RGAIN resistance value is too high, abnormal oscillation may occur during transient response time. The size of RGAIN should be carefully evaluated before connection.

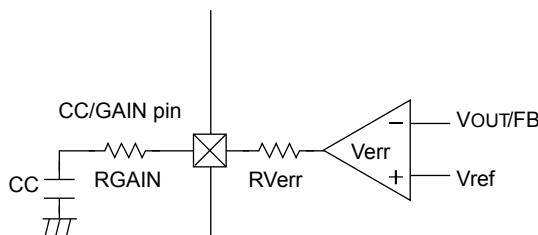

4. Current Limit

The current limit value is approximated by the following equation according to resistor RSEN inserted between the VIN and ISEN pins. Double function, current FB input and current limiting, is assigned to the ISEN pin. The current limiting value is approximated by the following equation according to the value for RSEN.

$$I_{Lpeak_limit} = 0.15/R_{SEN}$$

Example: When RSEN = 100 mΩ, $I_{Lpeak_limit} = 0.15/0.1 = 1.5 \text{ A}$

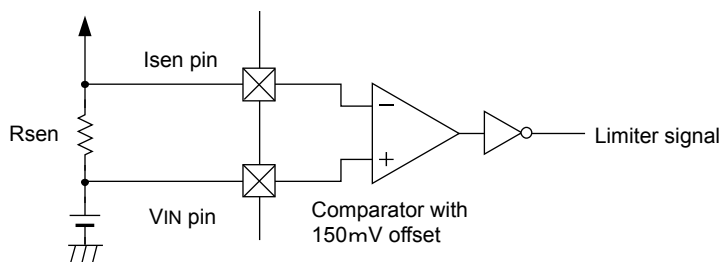

The inside error amplifier sends feedback signal when the voltage occurs at RSEN resistor because of the flow of coil current in order to phase compensate. The more the RSEN value becomes larger, the more the error signal becomes bigger, and it could lead to an intermittent oscillation. Please be careful if there is a problem with the application. Under the regular operation, a voltage created by a peak coil current at the RSEN resistor should be set lower than the current limit voltage 90 mV (MIN). For more details, please refer the notes on the external components.

OPERATIONAL EXPLANATION (Continued)

Functional Settings (Continued)

5. FB Voltage and C_{FB}

With regard to the XC9101D series, the output voltage is set by attaching externally divided resistors. The output voltage is determined by the equation shown below according to the values of R_{FB1} and R_{FB2} . In general, the sum of R_{FB1} and R_{FB2} should be 1 M Ω or less.

$$V_{OUT} = 0.9 \times (R_{FB1} + R_{FB2}) / R_{FB2}$$

The value of C_{FB} (phase compensation capacitor) is approximated by the following equation according to the values of R_{FB1} and f_{zfb} . The value of f_{zfb} should be 10 kHz, as a general rule.

$$C_{FB} = 1 / (2 \times \pi \times R_{FB1} \times f_{zfb})$$

Example: When $R_{FB1} = 455 \text{ k}\Omega$ and $R_{FB2} = 100 \text{ k}\Omega$: $V_{OUT} = 0.9 \times (455 \text{ k} + 100 \text{ k}) / 100 \text{ k} = 4.995 \text{ V}$
 : $C_{FB} = 1 / (2 \times \pi \times 455 \text{ k} \times 10 \text{ k}) = 34.98 \text{ pF}$

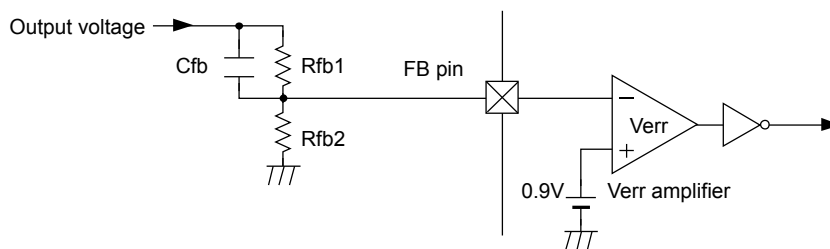

NOTES ON USE

Application Notes

1. The XC9101 series are designed for use with an output ceramic capacitor. If, however, the potential difference between input and output is too large, a ceramic capacitor may fail to absorb the resulting high switching energy and oscillation could occur on the output side. If the input-output potential difference is large, connect an electrolytic capacitor in parallel to compensate for insufficient capacitance.
2. The EXT pin of the XC9101 series is designed to minimize the through current that occurs in the internal circuitry. However, the gate drive of external NMOS has a low impedance for the sake of speed. Therefore, if the input voltage is high and the bypass capacitor is attached away from the IC, the charge/discharge current to the external NMOS may lead to unstable operations due to switching operation of the EXT pin.

As a solution to this problem, place the bypass capacitor as close to the IC as possible, so that voltage variations at the V_{IN} and V_{SS} pins caused by switching are minimized. If this is not effective, insert a resistor of several to several tens of ohms between the EXT pin and NMOS gate. Remember that the insertion of a resistor slows down the switching speed and may result in reduced efficiency.

3. A NPN transistor can be used in place of NMOS. If using a NPN transistor, insert a resistor (R_B) and capacitor (C_B) between the EXT pin and the base of the NPN transistor in order to limit the base current without slowing the switching speed. Adjust R_B in a range of 500 Ω to 1 k Ω according to the load and h_{FE} of the transistor. Use a ceramic capacitor for C_B , complying with $C_B \leq 1 / (2 \times \pi \times R_B \times F_{OSC} \times 0.7)$, as a rule.

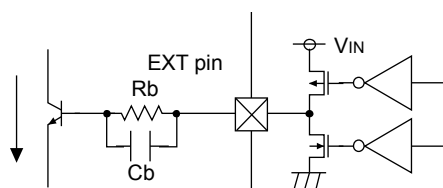

4. Although the C_{CLK} connection capacitance range is from 150 ~ 220pF, the most suitable value for maximum stability is around 180pF.

■ NOTES ON USE (Continued)

● Instruction on Pattern Layout

- ① In order to stabilize VDD voltage level, we recommend that a by-pass capacitor (CDD) be connected as close as possible to the VIN & VSS pins.
- ② In order to stabilize the GND voltage level which can fluctuate as a result of switching, we suggest that C_CLK, R_CLK and C_GAIN GND is separated from Power GND and connected as close as possible to the Vss pin (by-pass capacitor, CDD). Please use a multi layer board and check the wiring carefully.

< XC9101D Series Pattern Layout Examples >

2 Layer Better Evaluation Board

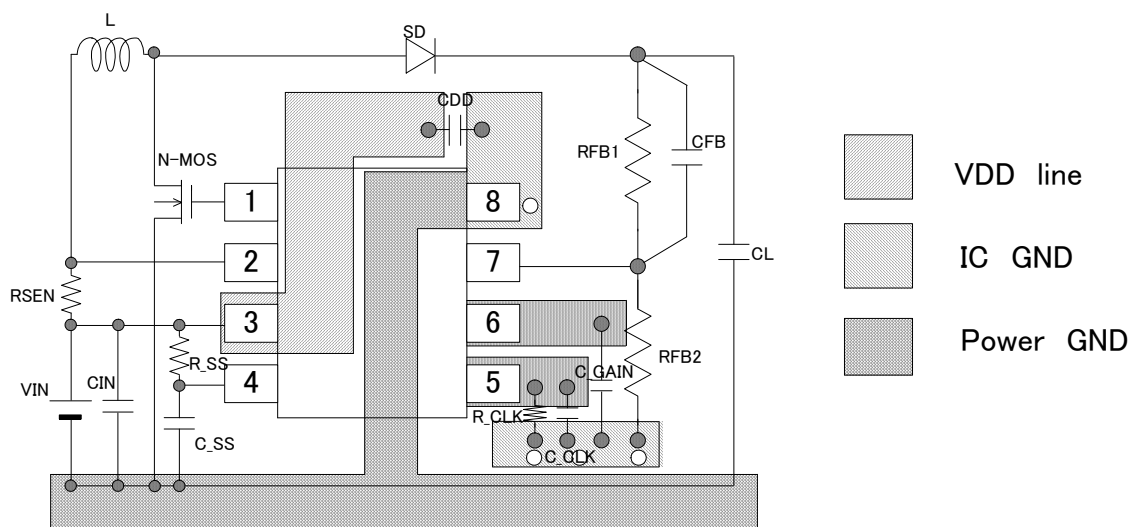

○ Through Hole

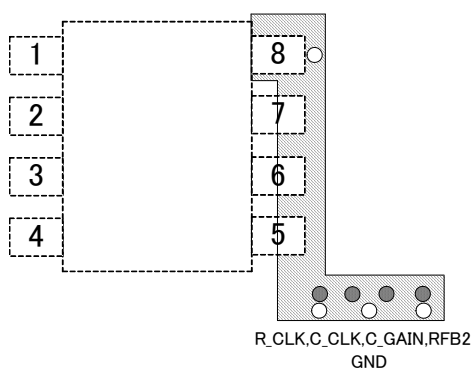

○ Through Hole

TEST CIRCUITS

• Circuit ① (V_{OUT} Type)

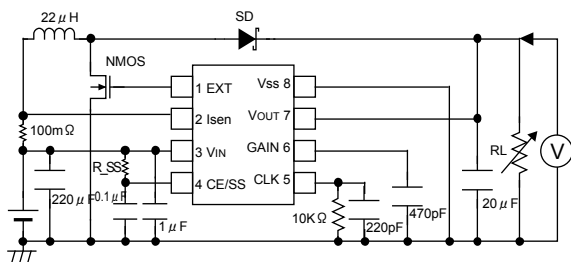

XC9101C33A R_{SS} : 104 kΩ C-SS : 0.1 μF
XC9101C50A R_{SS} : 138 kΩ C-SS : 0.1 μF

• Circuit ① (FB Type)

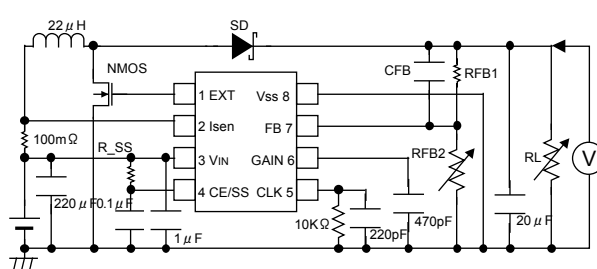

• Circuit ②

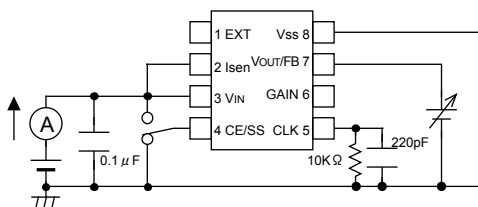

• Circuit ③

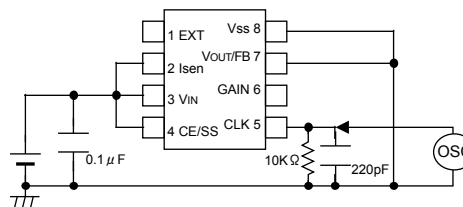

• Circuit ④

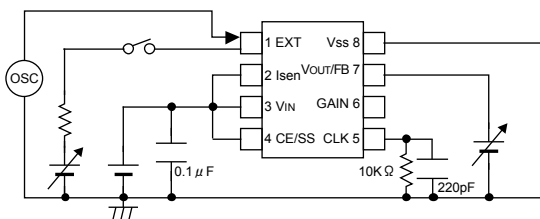

• Circuit ⑤

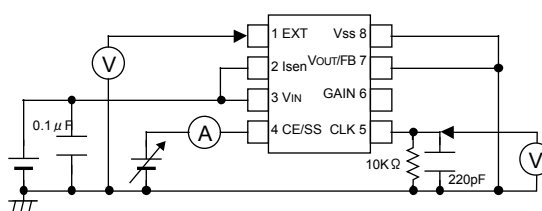

• Circuit ⑥

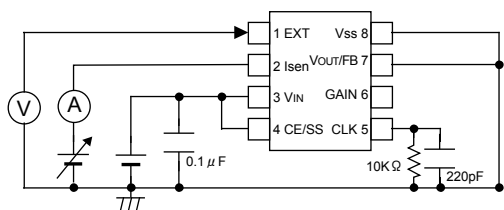

• Circuit ⑦

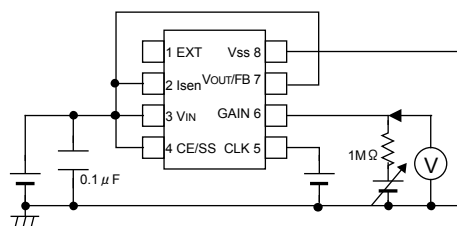

TYPICAL PERFORMANCE CHARACTERISTICS

XC9101D09AKR

(1) Output Voltage vs. Output Current

$V_{OUT} = 3.3V$, $F_{osc} : 180kHz$

$L=22\mu H$, $C_{IN}=220\mu F$ (Electrolytic)+ $10\mu F$ (Ceramic)
 $C_L=40\mu F$ (Ceramic), $R_{SEN}=50m\Omega$, $C_{DD}=1\mu F$ (Ceramic)
 SD: U3FWJ44N, $C_{GAIN}=470pF$ (Ceramic), Tr: XP161A1355PR

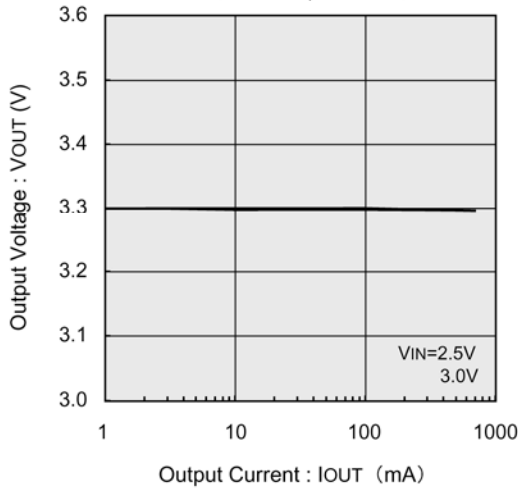

$V_{OUT} = 5.0V$, $F_{osc} : 180kHz$

$L=22\mu H$, $C_{IN}=220\mu F$ (Electrolytic)+ $10\mu F$ (Ceramic)
 $C_L=40\mu F$ (Ceramic), $R_{SEN}=50m\Omega$, $C_{DD}=1\mu F$ (Ceramic)
 SD: U3FWJ44N, $C_{GAIN}=470pF$ (Ceramic), Tr: XP161A1355PR

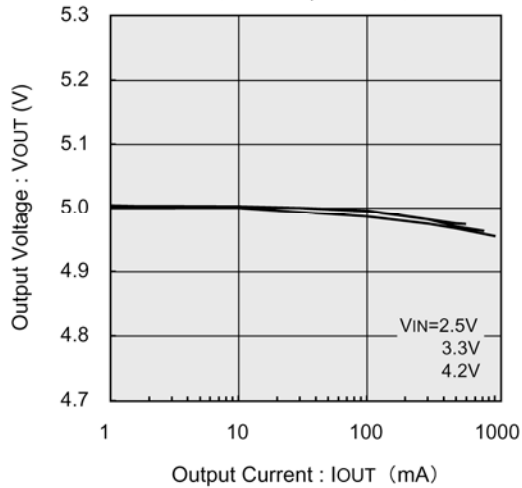

$V_{OUT} = 8.0V$, $F_{osc} : 330kHz$

$L=22\mu H$, $C_{IN}=220\mu F$ (Electrolytic)+ $10\mu F$ (Ceramic)
 $C_L=40\mu F$ (Ceramic), $R_{SEN}=50m\Omega$, $C_{DD}=1\mu F$ (Ceramic)
 SD: U3FWJ44N, $C_{GAIN}=470pF$ (Ceramic), Tr: XP161A1355PR

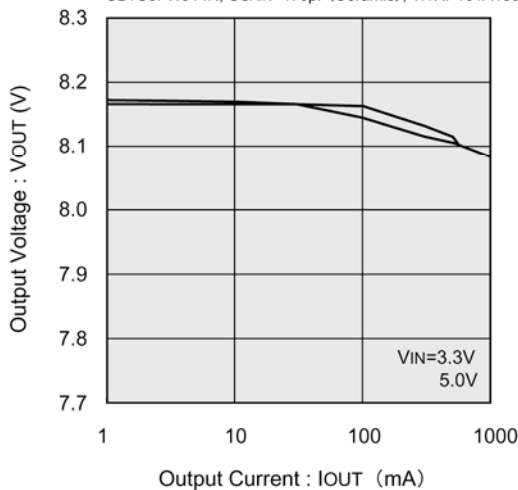

$V_{OUT} = 12.0V$, $F_{osc} : 330kHz$

$L=22\mu H$, $C_{IN}=220\mu F$ (Electrolytic)+ $10\mu F$ (Ceramic)
 $C_L=40\mu F$ (Ceramic), $R_{SEN}=50m\Omega$, $C_{DD}=1\mu F$ (Ceramic)
 SD: U3FWJ44N, $C_{GAIN}=470pF$ (Ceramic), Tr: XP161A1265PR

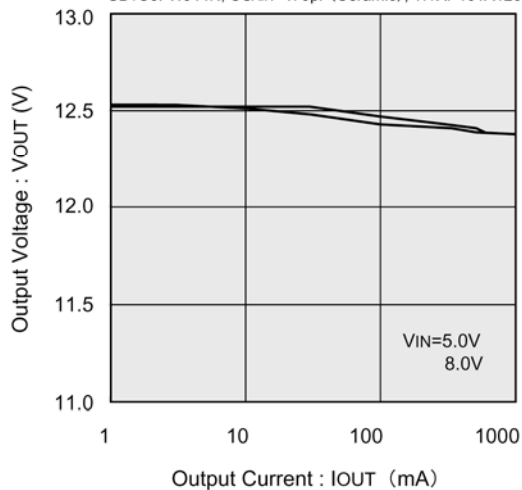

■ TYPICAL PERFORMANCE CHARACTERISTICS (Continued)

XC9101D09AKR

(2) Efficiency vs. Output Current

$V_{OUT} = 3.3V$, $F_{osc} : 180kHz$

$L=22\mu H$, $C_{IN}=220\mu F$ (Electrolytic)+ $10\mu F$ (Ceramic)
 $C_L=40\mu F$ (Ceramic), $R_{SEN}=50m\Omega$, $C_{DD}=1\mu F$ (Ceramic)
 $SD: U3FWJ44N$, $CGAIN=470pF$ (Ceramic), $Tr: XP161A1355PR$

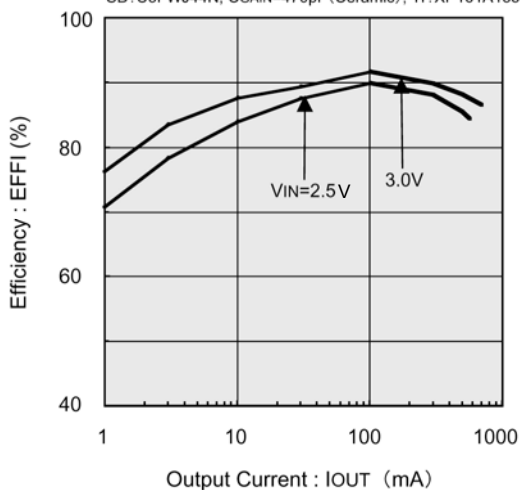

$V_{OUT} = 5.0V$, $F_{osc} : 180kHz$

$L=22\mu H$, $C_{IN}=220\mu F$ (Electrolytic)+ $10\mu F$ (Ceramic)
 $C_L=40\mu F$ (Ceramic), $R_{SEN}=50m\Omega$, $C_{DD}=1\mu F$ (Ceramic)
 $SD: U3FWJ44N$, $CGAIN=470pF$ (Ceramic), $Tr: XP161A1355PR$

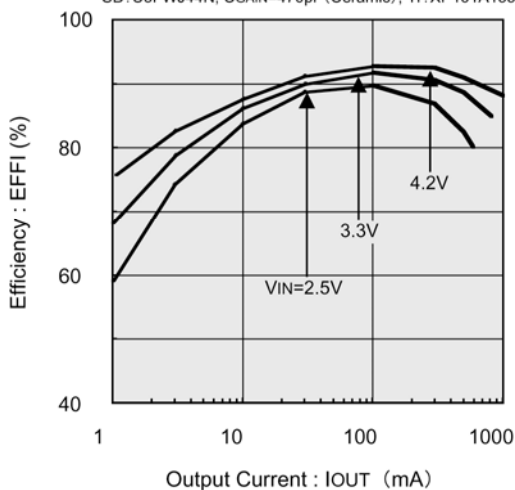

$V_{OUT} = 8.0V$, $F_{osc} : 180kHz$

$L=22\mu H$, $C_{IN}=220\mu F$ (Electrolytic)+ $10\mu F$ (Ceramic)
 $C_L=40\mu F$ (Ceramic), $R_{SEN}=50m\Omega$, $C_{DD}=1\mu F$ (Ceramic)
 $SD: U3FWJ44N$, $CGAIN=470pF$ (Ceramic), $Tr: XP161A1355PR$

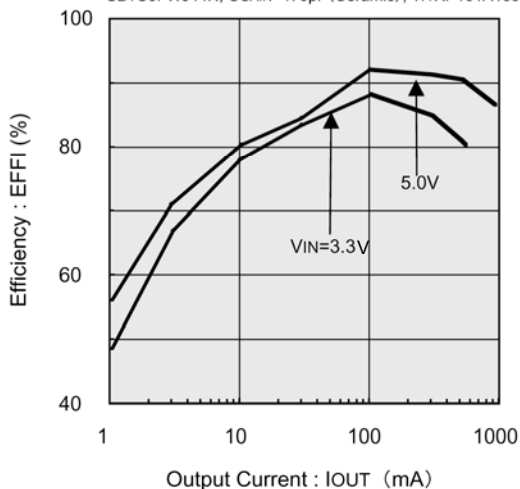

$V_{OUT} = 12.0V$, $F_{osc} : 180kHz$

$L=22\mu H$, $C_{IN}=220\mu F$ (Electrolytic)+ $10\mu F$ (Ceramic)
 $C_L=40\mu F$ (Ceramic), $R_{SEN}=50m\Omega$, $C_{DD}=1\mu F$ (Ceramic)
 $SD: U3FWJ44N$, $CGAIN=470pF$ (Ceramic), $Tr: XP161A1265PR$

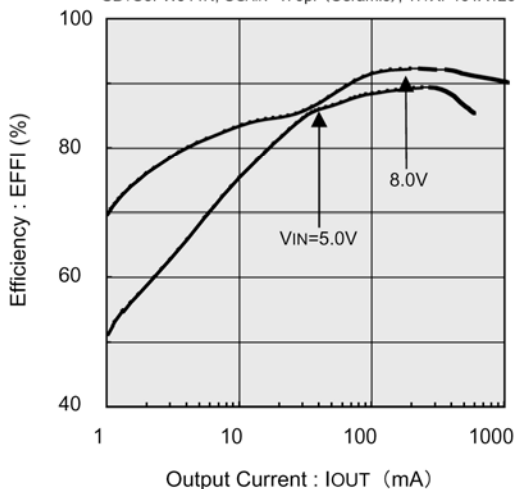

TYPICAL PERFORMANCE CHARACTERISTICS (Continued)

XC9101D09AKR

(3) Ripple Voltage vs. Output Current

$V_{OUT} = 3.3V$, $F_{OSC} : 180kHz$

$L=22\mu H$, $C_{IN}=220\mu F$ (Electrolytic)+ $10\mu F$ (Ceramic)
 $C_L=40\mu F$ (Ceramic), $R_{SEN}=50m\Omega$, $C_{DD}=1\mu F$ (Ceramic)
 SD:U3FWJ44N, $C_{GAIN}=470pF$ (Ceramic), Tr:XP161A1355PR

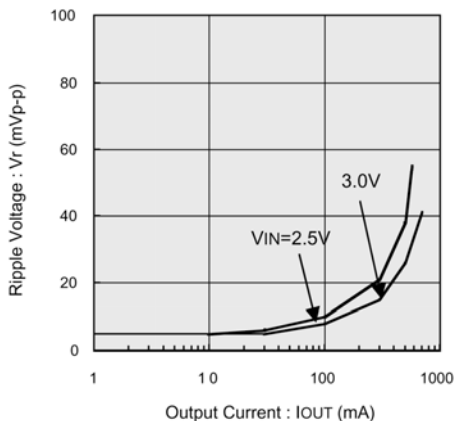

$V_{OUT} = 5.0V$, $F_{OSC} : 180kHz$

$L=22\mu H$, $C_{IN}=220\mu F$ (Electrolytic)+ $10\mu F$ (Ceramic)
 $C_L=40\mu F$ (Ceramic), $R_{SEN}=50m\Omega$, $C_{DD}=1\mu F$ (Ceramic)
 SD:U3FWJ44N, $C_{GAIN}=470pF$ (Ceramic), Tr:XP161A1355PR

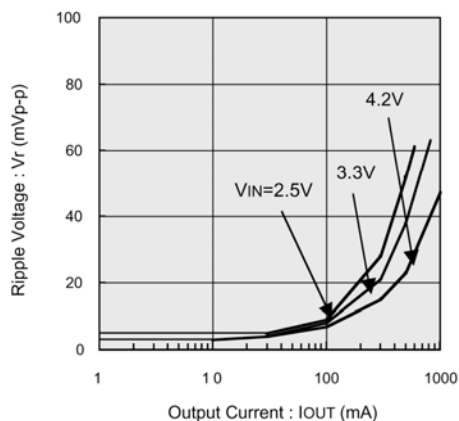

$V_{OUT} = 8.0V$, $F_{OSC} : 330kHz$

$L=22\mu H$, $C_{IN}=220\mu F$ (Electrolytic)+ $10\mu F$ (Ceramic)
 $C_L=40\mu F$ (Ceramic), $R_{SEN}=50m\Omega$, $C_{DD}=1\mu F$ (Ceramic)
 SD:U3FWJ44N, $C_{GAIN}=470pF$ (Ceramic), Tr:XP161A1355PR

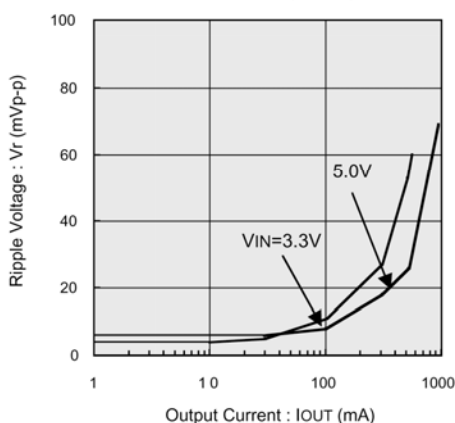

$V_{OUT} = 12.0V$, $F_{OSC} : 330kHz$

$L=22\mu H$, $C_{IN}=220\mu F$ (Electrolytic)+ $10\mu F$ (Ceramic)
 $C_L=40\mu F$ (Ceramic), $R_{SEN}=50m\Omega$, $C_{DD}=1\mu F$ (Ceramic)
 SD:U3FWJ44N, $C_{GAIN}=470pF$ (Ceramic), Tr:XP161A1265PR

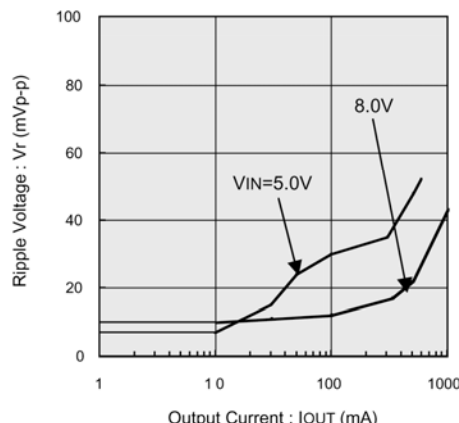

$V_{OUT} = 3.3V$, $F_{OSC} : 180kHz$

$L=22\mu H$, $C_L=94\mu F$ (Tantalum), $C_{IN}=94\mu F$ (Tantalum)
 $R_{SEN}=50m\Omega$, $C_{DD}=1\mu F$ (Ceramic)
 SD:U3FWJ44N, $C_{GAIN}=470pF$ (Ceramic), Tr:XP161A1355PR

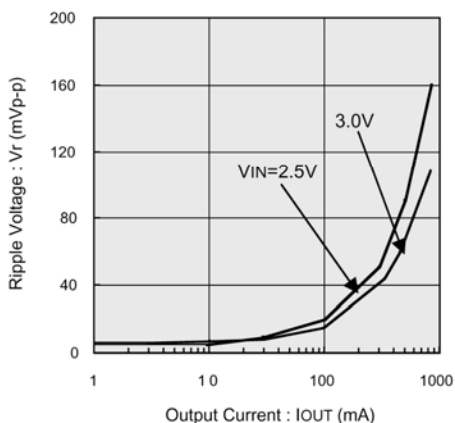

$V_{OUT} = 5.0V$, $F_{OSC} : 180kHz$

$L=22\mu H$, $C_L=94\mu F$ (Tantalum), $C_{IN}=94\mu F$ (Tantalum)
 $R_{SEN}=50m\Omega$, $C_{DD}=1\mu F$ (Ceramic)
 SD:U3FWJ44N, $C_{GAIN}=470pF$ (Ceramic), Tr:XP161A1355PR

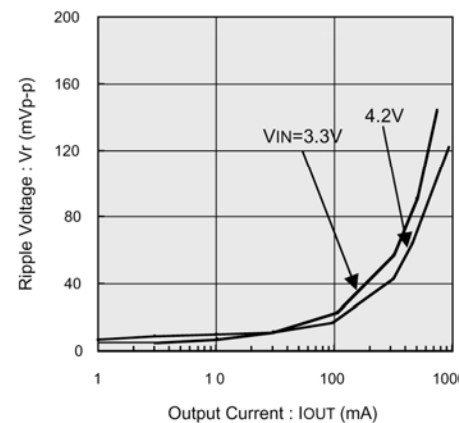

Note : If the difference between the input and output voltage is large or small, switching ON/OFF time will be shortened. As such, the external components used and their values (inductance value of the coil, resistor connected to CLK, capacitor etc.) may have a critical influence on the actual operation of the IC.

PACKAGING INFORMATION

●MSOP-8A

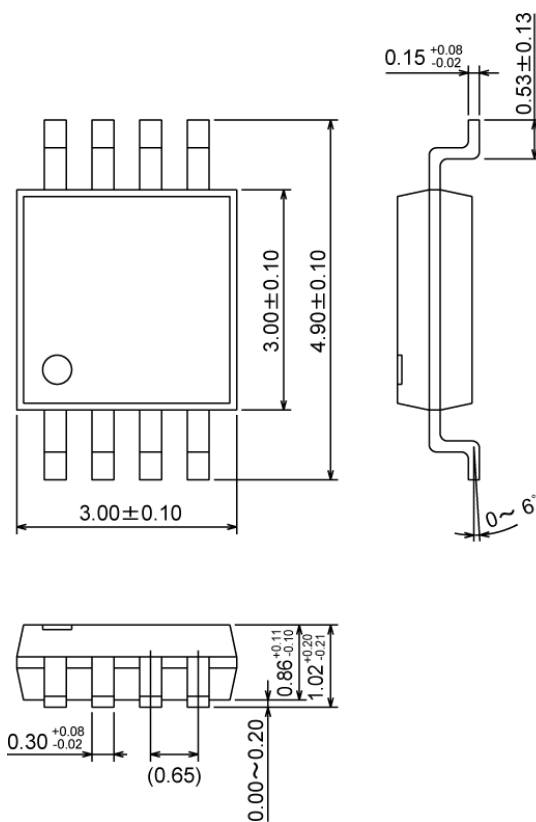

MARKING RULE

● MSOP-8A

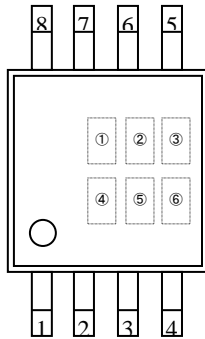

MSOP-8A
(TOP VIEW)

① represents product series

| MARK | PRODUCT SERIES |
|------|----------------|
| 4 | XC9101xxxAKx |

② represents type of DC/DC controller

| MARK | TYPE | PRODUCT SERIES |
|------|--------------|----------------|
| C | Vout, CE PIN | XC9101CxxAKx |
| D | FB, CE PIN | XC9101D09AKx |

③ represents integral number of output voltage, or FB type

| MARK | VOLTAGE (V) | PRODUCT SERIES |
|------|-------------|----------------|
| 2 | 2.x | XC9101C2xAKx |
| 3 | 3.x | XC9101C3xAKx |
| 4 | 4.x | XC9101C4xAKx |
| 5 | 5.x | XC9101C5xAKx |
| 6 | 6.x | XC9101C6xAKx |
| 7 | 7.x | XC9101C7xAKx |
| 8 | 8.x | XC9101C8xAKx |
| 9 | 9.x | XC9101C9xAKx |
| 0 | FB products | XC9101D09AKx |
| A | 10.x | XC9101CAxAKx |
| B | 11.x | XC9101CBxAKx |
| C | 12.x | XC9101CCxAKx |
| D | 13.x | XC9101CDxAKx |
| E | 14.x | XC9101CExAKx |
| F | 15.x | XC9101CFxAKx |
| H | 16.x | XC9101CHxAKx |

④ represents decimal number of output voltage, FB products (ex.)

| MARK | VOLTAGE (V) | PRODUCT SERIES |
|------|-------------|----------------|
| 0 | x.0 | XC9101Cx0AKx |
| 3 | x.3 | XC9101C3xAKx |
| 9 | FB products | XC9101D09AKx |

⑤ represents control type of oscillation frequency

| MARK | TYPE | PRODUCT SERIES |
|------|----------------------|----------------|
| A | Adjustable Frequency | XC9101xxxAKx |

⑥ represents production lot number

0 to 9, A to Z repeated (G, I, J, O, Q, W excepted).

Note: No character inversion used.

1. The product and product specifications contained herein are subject to change without notice to improve performance characteristics. Consult us, or our representatives before use, to confirm that the information in this datasheet is up to date.
2. The information in this datasheet is intended to illustrate the operation and characteristics of our products. We neither make warranties or representations with respect to the accuracy or completeness of the information contained in this datasheet nor grant any license to any intellectual property rights of ours or any third party concerning with the information in this datasheet.
3. Applicable export control laws and regulations should be complied and the procedures required by such laws and regulations should also be followed, when the product or any information contained in this datasheet is exported.
4. The product is neither intended nor warranted for use in equipment of systems which require extremely high levels of quality and/or reliability and/or a malfunction or failure which may cause loss of human life, bodily injury, serious property damage including but not limited to devices or equipment used in 1) nuclear facilities, 2) aerospace industry, 3) medical facilities, 4) automobile industry and other transportation industry and 5) safety devices and safety equipment to control combustions and explosions. Do not use the product for the above use unless agreed by us in writing in advance.
5. Although we make continuous efforts to improve the quality and reliability of our products; nevertheless Semiconductors are likely to fail with a certain probability. So in order to prevent personal injury and/or property damage resulting from such failure, customers are required to incorporate adequate safety measures in their designs, such as system fail safes, redundancy and fire prevention features.
6. Our products are not designed to be Radiation-resistant.
7. Please use the product listed in this datasheet within the specified ranges.
8. We assume no responsibility for damage or loss due to abnormal use.
9. All rights reserved. No part of this datasheet may be copied or reproduced unless agreed by Torex Semiconductor Ltd in writing in advance.

TOREX SEMICONDUCTOR LTD.

单击下面可查看定价，库存，交付和生命周期等信息

[>>Torex Semiconductor\(特瑞仕\)](#)