

400mA Synchronous Step-Down DC/DC Converters

GENERAL DESCRIPTION

GreenOperation Compatible

The XC9244/XC9245 series is a group of synchronous-rectification type step-down DC/DC converters with a built-in 0.65 P-channel MOS driver transistor and 0.45 N-channel MOS switching transistor, designed to allow the use of ceramic capacitors. Output current of 400mA (MAX.) to be configured using only a coil and capacitor connected externally.

The output voltage can be set from 0.8V to 4.0V in increments of 0.05V (accuracy: $\pm 2.0\%$). With an internal switching frequency of 1.2MHz, small external components can be used. USPN-6 package is suitable for the application which requires low profile and small-footprint.

The XC9244 series is PWM fixed frequency control, and the XC9245 series is PWM/PFM, which automatically switches from PWM to PFM during light loads, high efficiency can be achieved over a wide range of load conditions. When stand-by mode, due to stop all operation, supply current is reduced to $1\mu\text{A}$ or less. The integrated C_L discharge function which enables the electric charge at the output capacitor C_L to be discharged via the internal discharge switch located between the V_{OUT} and V_{SS} pins. The C_L discharge function prevents malfunction on V_{OUT} connecting application during stand-by mode.

The XC9244/XC9245 series has a high speed soft-start as fast as 0.25ms in typical for quick turn-on. Current limiter circuit (Constant Current & Latching) is built-in for preventing from thermal destruction. With UVLO (Under Voltage Lock Out) function, the internal P channel driver transistor is forced OFF when input voltage becomes 2.25V or lower.

APPLICATIONS

Smart phones / Mobile phones

Bluetooth

Mobile devices / terminals

Portable game consoles

Digital still cameras / Camcorders

Note PCs / Tablet PCs

FEATURES

Driver Transistor Built-In	: 0.65 P-ch Driver Transistor 0.45 N-ch Synchronous Switch Transistor
Input Voltage	: 2.3V ~ 6.0V
Output Voltage Selectable	: 0.8V ~ 4.0V (0.05V Increments)
High Efficiency	: 90% (TYP.)*
Output Current	: 400mA
Oscillation Frequency	: 1.2MHz $\pm 15\%$
Maximum Duty Cycle	: 100%
Function	: Current Limiter Circuit (Constant Current & Latching) C_L High Speed Discharge Soft Start Circuit
Capacitor	: Low ESR Ceramic Capacitor
Control Methods	: PWM (XC9244) PWM/PFM Auto (XC9245)
Operating Ambient Temperature	: -40 ~ +85
Package	: USPN-6
Environmentally Friendly	: EU RoHS Compliant, Pb Free

* The characteristics change with external parts, substrate wiring, etc.

TYPICAL APPLICATION CIRCUIT

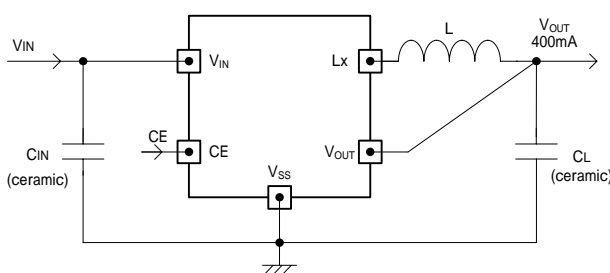

TYPICAL PERFORMANCE CHARACTERISTICS

XC9244/XC9245A33C

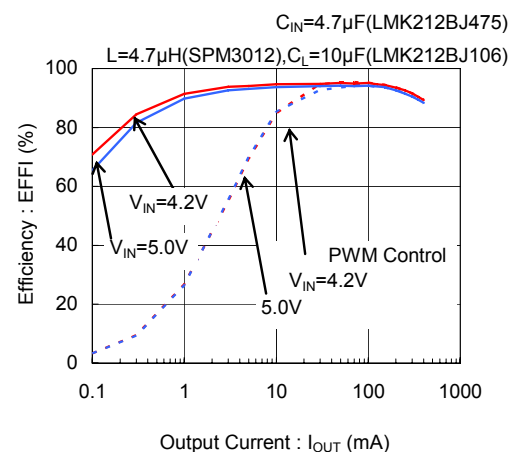

PIN CONFIGURATION

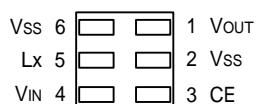

USPN-6
(BOTTOM VIEW)

*If the pad needs to be connected to other pins, it should be connected to the VSS (No. 2 and 6) pin.

PIN ASSIGNMENT

PIN NUMBER	PIN NAME	FUNCTION
USPN-6		
4	V _{IN}	Power Input
2, 6	V _{SS}	Ground
3	CE	Chip Enable
1	V _{OUT}	Output Voltage Monitor
5	L _x	Switching Output

FUNCTION

XC9244/XC9245 Series, Type A

PIN NAME	SIGNAL	STATUS
CE	L	Stand-by
	H	Active

* Please do not leave the CE pin open.

ABSOLUTE MAXIMUM RATINGS

T_a=25

PARAMETER	SYMBOL	RATINGS	UNITS
V _{IN} Pin Voltage	V _{IN}	-0.3 ~ +6.5	V
L _x Pin Voltage	V _{Lx}	-0.3 ~ V _{IN} +0.3 or +6.5 ^(*1)	V
V _{OUT} Pin Voltage	V _{OUT}	-0.3 ~ V _{IN} +0.3 or +6.5 ^(*1)	V
CE Pin Voltage	V _{CE}	-0.3 ~ +6.5	V
L _x Pin Current	I _{Lx}	±1500	mA
Power Dissipation	USPN-6	P _d	100
Operating Ambient Temperature	T _{opr}	-40 ~ +85	
Storage Temperature	T _{stg}	-55 ~ +125	

* All voltages are described based on the V_{SS} pin.

(*1) The maximum value should be either V_{IN}+0.3 or +6.5 in the lowest.

ELECTRICAL CHARACTERISTICS

XC9244/XC9245

Ta=25

PARAMETER	SYMBOL	CONDITIONS	MIN.	TYP.	MAX.	UNITS	CIRCUIT
Output Voltage	V _{OUT}	When connected to external components, V _{IN} =V _{CE} =5.0V, I _{OUT} =30mA	<E-1>	<E-2>	<E-3>	V	
Operating Voltage Range	V _{IN}		2.3	-	6.0	V	
Maximum Output Current	I _{OUTMAX}	When connected to external components (*1), V _{IN} =V _{CE} =V _{OUT(E)} +2.0V,	400	-	-	mA	
UVLO Voltage	V _{UVLO}	V _{IN} =V _{CE} , V _{OUT} =0V, Voltage which Lx pin holding "L" level (*2,*9)	1.60	1.90	2.25	V	
Quiescent Current	I _q	V _{IN} =V _{CE} =5.0V, V _{OUT} =V _{OUT(E)} × 1.1V	-	18	30	μA	
Stand-by Current	I _{STB}	V _{IN} =5.0V, V _{CE} =0V, V _{OUT} =0V	-	0.0	1.0	μA	
Oscillation Frequency	f _{OSC}	When connected to external components, V _{IN} =V _{CE} =5.0V, I _{OUT} =200mA	1020	1200	1380	kHz	
PFM Switch Current (*3)	I _{PFM}	When connected to external components, V _{IN} =V _{CE} = (C-1), I _{OUT} =1mA	125	180	235	mA	
PFM Duty Limit (*3)	DTY _{LIMIT_PFM}	V _{IN} =V _{CE} = (C-2), I _{OUT} =1mA	-	-	300	%	
Maximum Duty Cycle	D _{MAX}	V _{IN} =V _{CE} =5.0V, V _{OUT} =V _{OUT(E)} × 0.9V	100	-	-	%	
Minimum Duty Cycle	D _{MIN}	V _{IN} =V _{CE} =5.0V, V _{OUT} =V _{OUT(E)} × 1.1V	-	-	0	%	
Efficiency	EFFI	When connected to external components, V _{IN} =V _{CE} =V _{OUT(E)} +1.5V, I _{OUT} =100mA (*4)	-	<E-4>	-	%	
Lx SW"H"ON Resistance	R _{LXH}	V _{IN} =V _{CE} =5.0V, V _{OUT} =0V, I _{LX} =100mA (*5)	-	0.65	0.85		
Lx SW"L"ON Resistance	R _{LXL}	V _{IN} =V _{CE} =5.0V	-	0.45(*6)	0.65(*6)		-
Lx SW"H" Leakage Current (*7)	I _{LeakH}	V _{IN} =V _{OUT} =5.0V, V _{CE} =0V, V _{LX} =0V	-	0.00	1.00	μA	
Lx SW"L" Leakage Current (*7)	I _{LeakL}	V _{IN} =V _{OUT} =5.0V, V _{CE} =0V, V _{LX} =5.0V	-	0.00	1.00	μA	
Current Limit (*8)	I _{LIM}	V _{IN} =V _{CE} =5.0V, V _{OUT} =V _{OUT(E)} × 0.9V	700	900	1200	mA	
Output Voltage Temperature Characteristics	ΔV _{OUT} / (V _{OUT} ·ΔTopr)	I _{OUT} =30mA, -40 Topr 85	-	±100	-	ppm/	
CE "H" Voltage	V _{CEH}	V _{IN} =5.0V, V _{OUT} =0V, Applied voltage to V _{CE} , Voltage changes Lx to "H" level (*9)	1.20	-	6.00	V	
CE "L" Voltage	V _{CEL}	V _{IN} =5.0V, V _{OUT} =0V, Applied voltage to V _{CE} , Voltage changes Lx to "L" level (*9)	V _{SS}	-	0.25	V	
CE "H" Current	I _{CEH}	V _{IN} =5.0V, V _{CE} =5.0V, V _{OUT} =0V	-0.1	-	0.1	μA	
CE "L" Current	I _{CEL}	V _{IN} =5.0V, V _{CE} =0V, V _{OUT} =0V	-0.1	-	0.1	μA	
Soft-Start Time	t _{SS}	When connected to external components, V _{IN} =5.0V, V _{CE} =0V → 5.0V, I _{OUT} =1mA	-	0.25	-	ms	
Latch Time	t _{LAT}	V _{IN} =V _{CE} =5.0V, V _{OUT} =0.8×V _{OUT(E)} , Short Lx at 1 resistance (*10)	0.50	1.00	5.00	ms	
C _L Discharge	R _{DCHG}	V _{IN} =5.0V, V _{CE} =0V, V _{OUT} =5.0V	50	120	200		

NOTE:

Unless otherwise stated, V_{IN}=5.0V, V_{OUT(E)}=Nominal Voltage

(*1) When the difference between the input and the output is small, some cycles may be skipped completely before current maximizes.

If current is further pulled from this state, output voltage will decrease because of P-ch driver ON resistance.

(*2) Including UVLO detect voltage, hysteresis operating voltage range for UVLO release voltage. UVLO release voltage is V_{IN} voltage which is Lx pin becomes "H".

(*3) XC9244 series exclude I_{PFM} and DTY_{LIMIT_PFM} because those are only for the PFM control's functions.

(*4) EFFI = { (output voltage × output current) / (input voltage × input current) } × 100

(*5) ON resistance= (V_{IN} - Lx pin measurement voltage) / 100mA

(*6) Design value

(*7) When temperature is high, a current of approximately 10 μA (maximum) may leak.

(*8) Current limit denotes the level of detection at peak of coil current.

(*9) "H" = V_{IN} - V_{IN} - 1.2V, "L" = + 0.1V ~ - 0.1V

(*10) Time until it short-circuits V_{OUT} with GND via 1 of resistor from an operational state and is set to Lx=0V from current limit pulse generating.

ELECTRICAL CHARACTERISTICS (Continued)

SPEC Table

1) I_{PFM} , DTY_{LIMIT_PFM} , V_{OUT} , $EFFI$

NOMINAL OUTPUT VOLTAGE	I_{PFM}	DTY_{LIMIT_PFM}	V_{OUT}			$EFFI$ (TYP.)
	<C-1>	<C-2>	<E-1>	<E-2>	<E-3>	<E-4>
			MIN.	TYP.	MAX.	
$V_{OUT(E)}$						
0.80	3.6V	2.3V	0.784	0.800	0.816	77
0.85			0.833	0.850	0.867	78
0.90			0.882	0.900	0.918	79
0.95			0.931	0.950	0.969	80
1.00			0.980	1.000	1.020	81
1.05			1.029	1.050	1.071	82
1.10			1.078	1.100	1.122	83
1.15			1.127	1.150	1.173	84
1.20			1.176	1.200	1.224	85
1.25			1.225	1.250	1.275	85
1.30			1.274	1.300	1.326	86
1.35			1.323	1.350	1.377	86
1.40			1.372	1.400	1.428	86
1.45			1.421	1.450	1.479	86
1.50			1.470	1.500	1.530	87
1.55			1.519	1.550	1.581	87
1.60	1.568	1.600	1.632	87		
1.65	$V_{OUT(E)+2.0V}$	2.3V	1.617	1.650	1.683	87
1.70			1.666	1.700	1.734	88
1.75			1.715	1.750	1.785	88
1.80			1.764	1.800	1.836	88
1.85			1.813	1.850	1.887	88
1.90			1.862	1.900	1.938	89
1.95			1.911	1.950	1.989	89
2.00			1.960	2.000	2.040	89
2.05		2.009	2.050	2.091	89	
2.10		2.058	2.100	2.142	89	
2.15		2.107	2.150	2.193	90	
2.20		2.156	2.200	2.244	90	
2.25		2.205	2.250	2.295	90	
2.30		2.254	2.300	2.346	90	
2.35		2.303	2.350	2.397	90	
2.40		2.352	2.400	2.448	91	
2.45	2.401	2.450	2.499	91		
2.50	2.450	2.500	2.550	91		
2.55	2.499	2.550	2.601	91		
2.60	2.548	2.600	2.652	91		
2.65	2.597	2.650	2.703	91		
2.70	2.646	2.700	2.754	92		
		$V_{OUT(E)+0.5V}$				

ELECTRICAL CHARACTERISTICS (Continued)

SPEC Table

1) I_{PFM} , DTY_{LIMIT_PFM} , V_{OUT} , $EFFI$

NOMINAL OUTPUT VOLTAGE	I_{PFM}	DTY_{LIMIT_PFM}	V_{OUT}			$EFFI$ (TYP.)
	<C-1>	<C-2>	<E-1>	<E-2>	<E-3>	<E-4>
$V_{OUT(E)}$			MIN.	TYP.	MAX.	
2.75	$V_{OUT(E)}+2.0V$	$V_{OUT(E)}+0.5V$	2.695	2.750	2.805	92
2.80			2.744	2.800	2.856	92
2.85			2.793	2.850	2.907	92
2.90			2.842	2.900	2.958	92
2.95			2.891	2.950	3.009	92
3.00			2.940	3.000	3.060	92
3.05			2.989	3.050	3.111	92
3.10			3.038	3.100	3.162	93
3.15			3.087	3.150	3.213	93
3.20			3.136	3.200	3.264	93
3.25			3.185	3.250	3.315	93
3.30			3.234	3.300	3.366	93
3.35			3.283	3.350	3.417	93
3.40			3.332	3.400	3.468	93
3.45			3.381	3.450	3.519	93
3.50			3.430	3.500	3.570	93
3.55			3.479	3.550	3.621	93
3.60			3.528	3.600	3.672	93
3.65			3.577	3.650	3.723	93
3.70			3.626	3.700	3.774	93
3.75	3.675	3.750	3.825	94		
3.80	3.724	3.800	3.876	94		
3.85	3.773	3.850	3.927	94		
3.90	3.822	3.900	3.978	94		
3.95	3.871	3.950	4.029	94		
4.00	3.920	4.000	4.080	94		

TYPICAL APPLICATION CIRCUIT

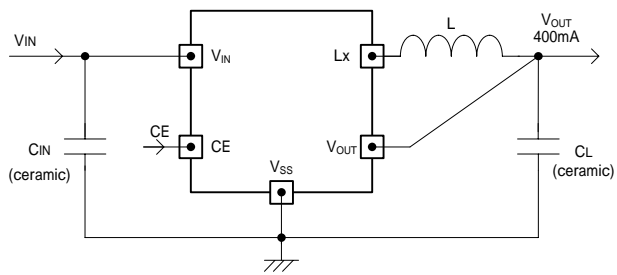

External Components

	MANUFACTURE	PRODUCT NUMBER	RATED VOLTAGE / INDUCTANCE	DIMENTION (mm)
L	TDK	SPM3012-4R7	4.7 μ H	3.2 x 3.0 x h1.2
	TAIYO YUDEN	NR3015-4R7	4.7 μ H	3.0 x 3.0 x h1.5
	Coilcraft	EPL3015-4R7	4.7 μ H	3.2 x 3.2 x h1.55
C _{IN}	TAIYO YUDEN	LMK212ABJ475KG	10V / 4.7 μ F	2.0 x 1.25 x h1.4
	KYOCERA	CM105X5R475K10A	10V / 4.7 μ F	1.6 x 0.8 x h1.0
C _L	TAIYO YUDEN	LMK212ABJ106KG	10V / 10 μ F	2.0 x 1.25 x h1.4
	KYOCERA	CM105X5R106M10A	10V / 10 μ F	1.6 x 0.8 x h1.0

OPERATIONAL DESCRIPTION

The XC9244/XC9245 series consists of a reference voltage source, ramp wave circuit, error amplifier, PWM comparator, phase compensation circuit, output voltage adjustment resistors, P-channel MOS driver transistor, N-channel MOS switching transistor for the synchronous switch, current limiter circuit, UVLO circuit and others. (See the block diagram below.)

The series ICs compare, using the error amplifier, the voltage of the internal voltage reference source with the feedback voltage from the V_{OUT} pin through split resistors, R1 and R2. Phase compensation is performed on the resulting error amplifier output, to input a signal to the PWM comparator to determine the turn-on time during PWM operation. The PWM comparator compares, in terms of voltage level, the signal from the error amplifier with the ramp wave from the ramp wave circuit, and delivers the resulting output to the buffer driver circuit to cause the Lx pin to output a switching duty cycle. This process is continuously performed to ensure stable output voltage. The current feedback circuit monitors the P-channel MOS driver transistor current for each switching operation, and modulates the error amplifier output signal to provide multiple feedback signals. This enables a stable feedback loop even when a low ESR capacitor such as a ceramic capacitor is used ensuring stable output voltage.

XC9244/XC9245 Series, Type A

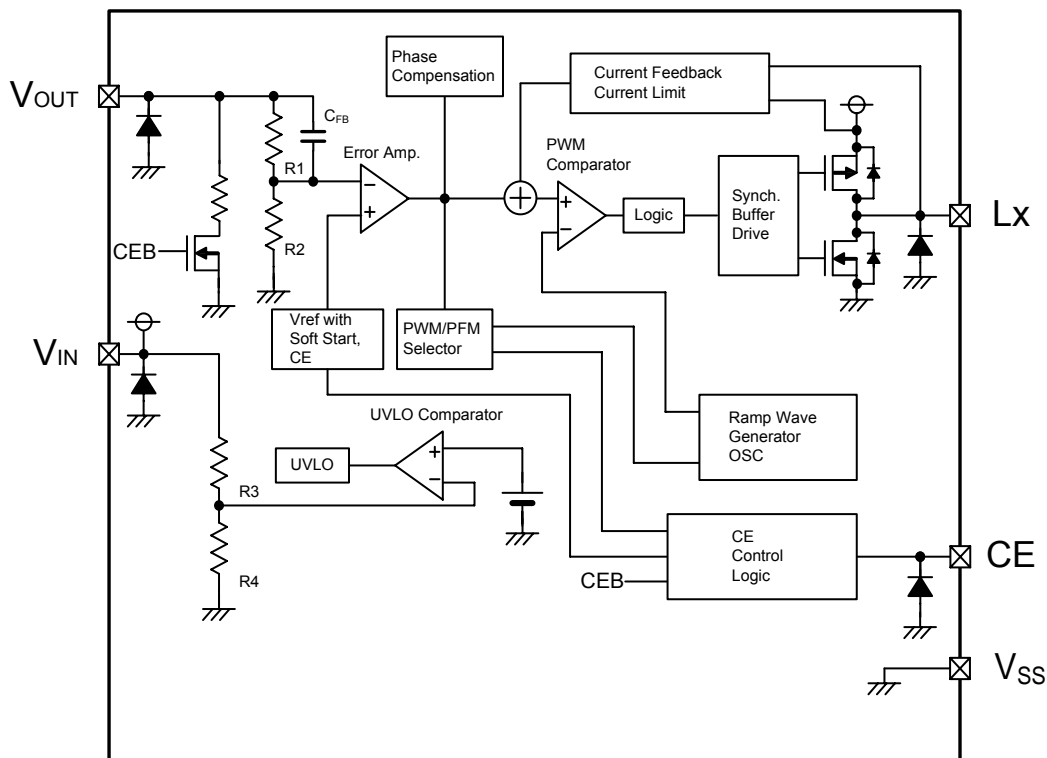

<Reference Voltage Source>

The reference voltage source provides the reference voltage to ensure stable output voltage of the DC/DC converter.

<Ramp Wave Circuit>

The ramp wave circuit determines switching frequency. The frequency is fixed internally as 1.2MHz. Clock pulses generated in this circuit are used to produce ramp waveforms needed for PWM operation, and to synchronize all the internal circuits.

<Error Amplifier>

The error amplifier is designed to monitor output voltage. The amplifier compares the reference voltage with the feedback voltage divided by the internal split resistors, R1 and R2. When a voltage lower than the reference voltage is fed back, the output voltage of the error amplifier increases. The gain and frequency characteristics of the error amplifier output are fixed internally to deliver an optimized signal to the mixer. The error amplifier output signal optimized in the mixer is modulated with the current feedback signal. This signal is delivered to the PWM comparator.

OPERATIONAL DESCRIPTION (Continued)

<Current Limit>

The current limiter circuit of the XC9244/XC9245 series monitors the current flowing through the P-channel MOS driver transistor connected to the Lx pin, and features a combination of the current limit mode and the operation suspension mode.

When the driver current is greater than a specific level, the current limit function operates to turn off the pulses from the Lx pin at any given timing.

When the P-channel MOS driver transistor is turned off, the limiter circuit is then released from the current limit detection state.

At the next pulse, the P-channel MOS driver transistor is turned on. However, the P-channel MOS driver transistor is immediately turned off in the case of an over current state.

When the over current state is eliminated, the IC resumes its normal operation.

The IC waits for the over current state to end by repeating the steps through . If an over current state continues for a few ms and the above three steps are repeatedly performed, the IC performs the function of latching the OFF state of the P-channel MOS driver transistor, and goes into operation suspension mode. Once the IC is in suspension mode, operations can be resumed by either turning the IC off via the CE/MODE pin, or by restoring power to the V_{IN} pin. The suspension mode does not mean a complete shutdown, but a state in which pulse output is suspended; therefore, the internal circuitry remains in operation. The current limit of the XC9244/XC9245 series can be set at 900mA at typical. Besides, care must be taken when laying out the PC Board, in order to prevent misoperation of the current limit mode. Depending on the state of the PC Board, latch time may become longer and latch operation may not work. In order to avoid the effect of noise, the board should be laid out so that input capacitors are placed as close to the IC as possible.

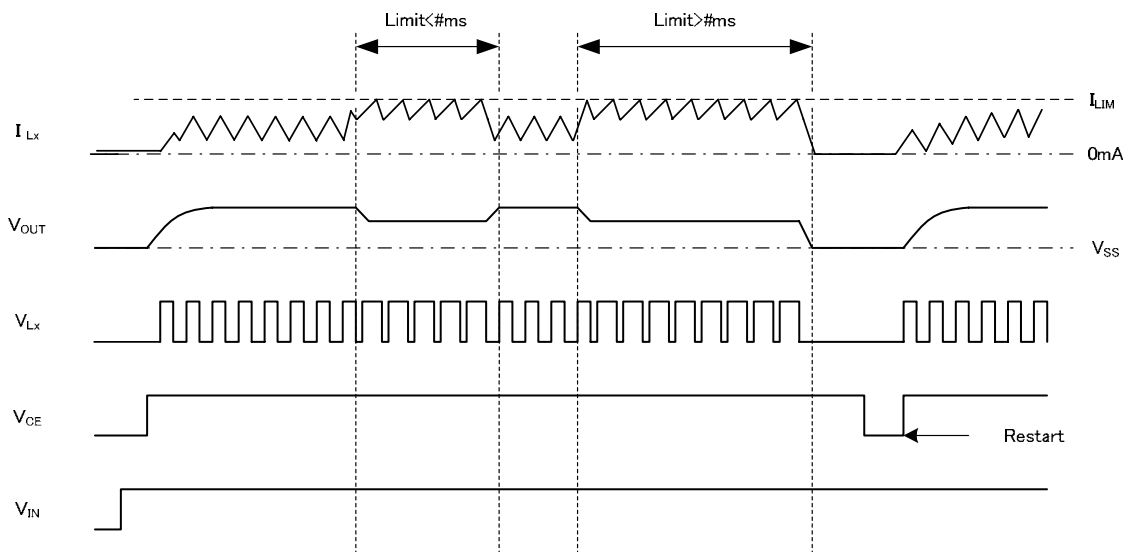

<UVLO Circuit>

When the V_{IN} voltage becomes 1.6V or lower, the P-ch MOS driver transistor output driver transistor is forced OFF to prevent false pulse output caused by unstable operation of the internal circuitry. When the V_{IN} pin voltage becomes 2.25V or higher, switching operation takes place. By releasing the UVLO function, the IC performs the soft start function to initiate output startup operation. The soft start function operates even when the V_{IN} pin voltage falls momentarily below the UVLO operating voltage. The UVLO circuit does not cause a complete shutdown of the IC, but causes pulse output to be suspended; therefore, the internal circuitry remains in operation.

<PFM Switch Current> (*1)

In PFM control operation, until coil current reaches to a specified level (I_{PFM}), the IC keeps the P-ch MOS driver transistor on. In this case, time that the P-ch MOS driver transistor is kept on (t_{ON}) can be given by the following formula.

$$t_{ON} = L \times I_{PFM} / (V_{IN} - V_{OUT}) \quad I_{PFM}$$

< PFM Duty Limit > (*1)

In PFM control operation, the PFM duty limit (DTY_{LIMIT_PFM}) is set to 300% (MAX.).

Therefore, under the condition that the duty increases (e.g. the condition that the step-down ratio is small), it's possible for P-ch MOS driver transistor to be turned off even when coil current doesn't reach to I_{PFM}. I_{PFM}

(* 1) XC9244 series exclude.

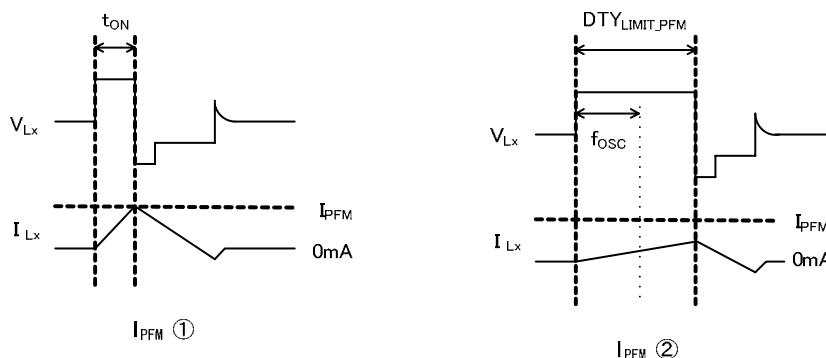

OPERATIONAL DESCRIPTION (Continued)

<C_L High Speed Discharge>

XC9244/ XC9245 series can quickly discharge the electric charge at the output capacitor (C_L) when a low signal to the CE pin which enables a whole IC circuit put into OFF state, is inputted via the N-ch MOS switch transistor located between the V_{OUT} pin and the V_{SS} pin. When the IC is disabled, electric charge at the output capacitor (C_L) is quickly discharged so that it may avoid application malfunction. Discharge time of the output capacitor (C_L) is set by the C_L auto-discharge resistance (R) and the output capacitor (C_L). By setting time constant of a C_L auto-discharge resistance value [R_{DCHG}] and an output capacitor value (C_L) as (= C_L × R_{DCHG}), discharge time of the output voltage after discharge via the N-channel transistor is calculated by the following formulas.

$$V = V_{OUT(E)} \times e^{-t/\tau} \quad \text{or} \quad t = \tau \ln(V_{OUT(E)}/V)$$

V: Output voltage after discharge

V_{OUT(E)}: Output voltage

t: Discharge time

$$\tau = C_L \times R_{DCHG}$$

C_L: Capacitance of Output capacitor

R_{DCHG}: C_L auto-discharge resistance

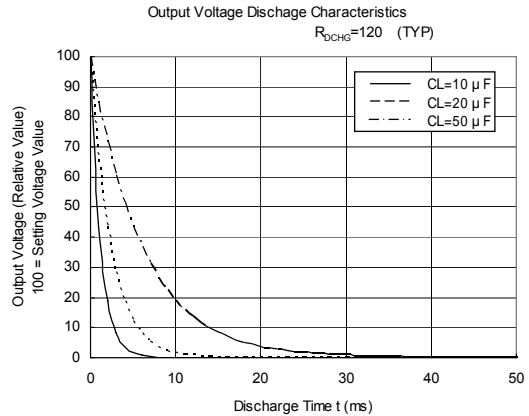

<CE Pin Function>

The operation of the XC9244/XC9245 series will enter into the shut down mode when a low level signal is input to the CE pin. During the shutdown mode, the current consumption of the IC becomes 0 µA (TYP.), with a state of high impedance at the Lx pin and C_L high speed discharge at V_{OUT} pin. The IC starts its operation by inputting a high level signal to the CE pin. The input to the CE pin is a CMOS input and the sink current is 0 µA (TYP.).

1) XC9244/XC9245 series - Examples of how to use CE pin

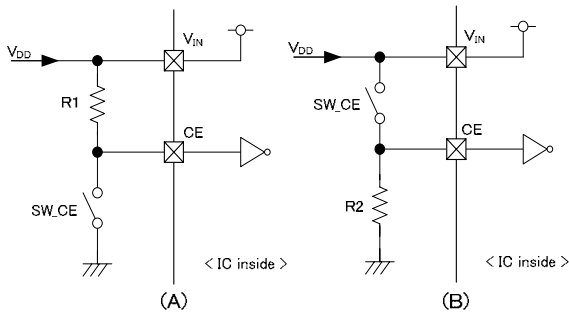

SW_CE	STATUS
ON	Stand-by
OFF	Operation

SW_CE	STATUS
ON	Stand-by
OFF	Operation

<Soft Start>

The XC9244/ XC9245 series provide 0.25ms (TYP). Soft start time is defined as the time interval to reach 90% of the output voltage from the time when the V_{CE} is turned on.

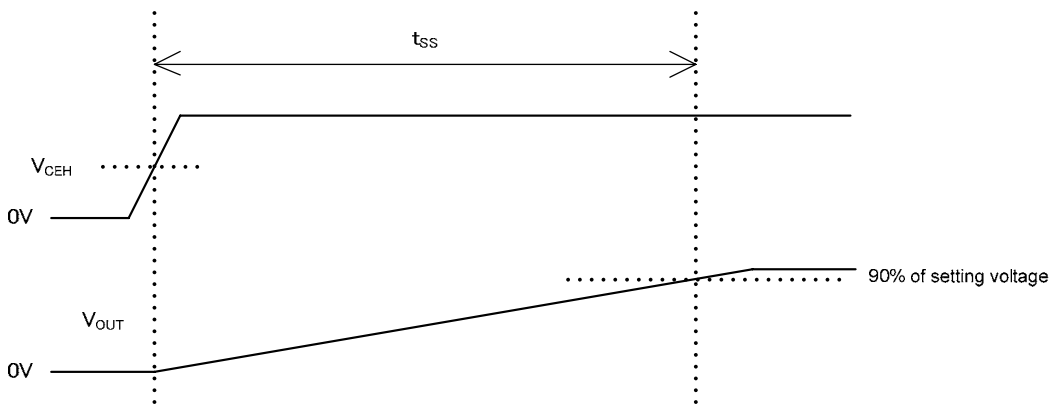

NOTE ON USE

1. Please use this IC within the stated maximum ratings. For temporary, transitional voltage drop or voltage rising phenomenon, the IC is liable to malfunction should the ratings be exceeded.
2. Spike noise and ripple voltage arise in a switching regulator as with a DC/DC converter. These are greatly influenced by external component selection, such as the coil inductance, capacitance values, and board layout of external components. Once the design has been completed, verification with actual components should be done.
3. When the difference between V_{IN} and V_{OUT} is large in PWM control, very narrow pulses will be outputted, and there is the possibility that some cycles may be skipped completely.
4. When the difference between V_{IN} and V_{OUT} is small, and the load current is heavy, very wide pulses will be outputted and there is the possibility that some cycles may be skipped completely.

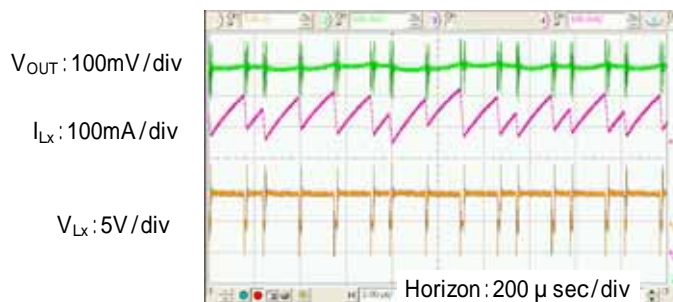

5. With the IC, the peak current of the coil is controlled by the current limit circuit. Since the peak current increases when dropout voltage or load current is high, current limit starts operation, and this can lead to instability. When peak current becomes high, please adjust the coil inductance value and fully check the circuit operation. In addition, please calculate the peak current according to the following formula:

$$I_{pk} = (V_{IN} - V_{OUT}) \times \text{OnDuty} / (2 \times L \times f_{OSC}) + I_{OUT}$$

L: Coil Inductance Value

f_{OSC} : Oscillation Frequency

6. When the peak current which exceeds limit current flows within the specified time, the built-in P-ch MOS driver transistor turns off. During the time until it detects limit current and before the built-in transistor can be turned off, the current for limit current flows; therefore, care must be taken when selecting the rating for the external components such as a coil.
7. Care must be taken when laying out the PC Board, in order to prevent misoperation of the current limit mode. Depending on the state of the PC Board, latch time may become longer and latch operation may not work. In order to avoid the effect of noise, the board should be laid out so that input capacitors are placed as close to the IC as possible.
8. Please do not use the IC at voltages below the recommended voltage range.
9. This IC should be used within the stated absolute maximum ratings in order to prevent damage to the device.
10. When the IC is used in high temperature, output voltage may increase up to input voltage level at no load because of the leak current of the driver transistor.
11. The current limit is set to 1200mA (MAX.) at typical. However, the current of 1200mA or more may flow. In case that the current limit functions while the V_{OUT} pin is shorted to the GND pin, when P-ch MOS driver transistor is ON, the potential difference for input voltage will occur at both ends of a coil. For this, the time rate of coil current becomes large. By contrast, when N-ch MOS driver transistor is ON, there is almost no potential difference at both ends of the coil since the V_{OUT} pin is shorted to the GND pin. Consequently, the time rate of coil current becomes quite small. According to the repetition of this operation, and the delay time of the circuit, coil current will be converged on a certain current value, exceeding the amount of current, which is supposed to be limited originally. Even in this case, however, after the over current state continues for several ms, the circuit will be latched. A coil should be used within the stated absolute maximum rating in order to prevent damage to the device.

Current flows into P-ch MOS driver transistor to reach the current limit (I_{LIM}).

The current of I_{LIM} or more flows since the delay time of the circuit occurs during from the detection of the current limit to OFF of P-ch MOS driver transistor. Because of no potential difference at both ends of the coil, the time rate of coil current becomes quite small.

Lx oscillates very narrow pulses by the current limit for several ms.

The circuit is latched, stopping its operation.

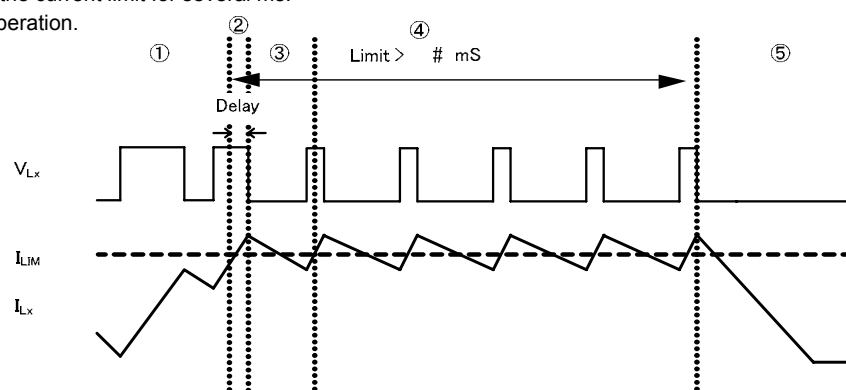

NOTE ON USE (Continued)

12. In order to stabilize V_{IN} 's voltage level, we recommend that a by-pass capacitor (C_{IN}) be connected as close as possible to the V_{IN} & V_{SS} pins.
13. In case of $V_{IN} < 2.5V$, the maximum load current may be decreased less than 400mA due to the characteristics of current limit.
14. Torex places an importance on improving our products and their reliability.
We request that users incorporate fail-safe designs and post-aging protection treatment when using Torex products in their systems.

Instructions of pattern layouts

1. In order to stabilize V_{IN} voltage level, we recommend that a by-pass capacitor (C_{IN}) be connected as close as possible to the V_{IN} & V_{SS} pins.
2. Please mount each external component as close to the IC as possible.
3. Wire external components as close to the IC as possible and use thick, short connecting traces to reduce the circuit impedance.
4. Make sure that the PCB GND traces are as thick as possible, as variations in ground potential caused by high ground currents at the time of switching may result in instability of the IC.
5. This series' internal P-ch driver transistors bring on heat because of the output current and ON resistance of driver transistors.

Recommended Pattern Layout

1st Layer

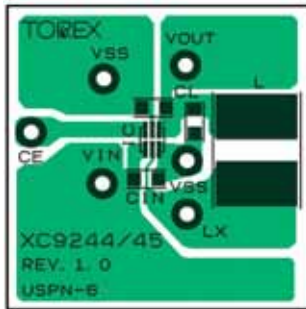

2nd Layer



PCB

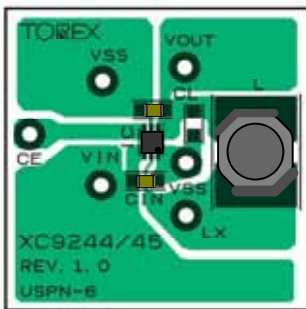

TEST CIRCUITS

< Circuit No.1 >

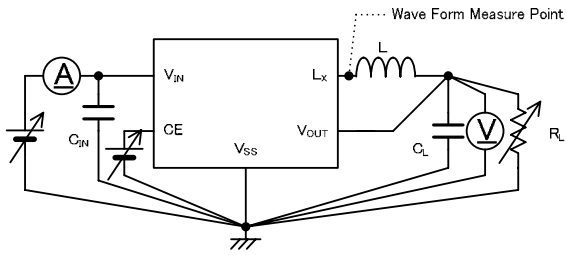

< Circuit No.2 >

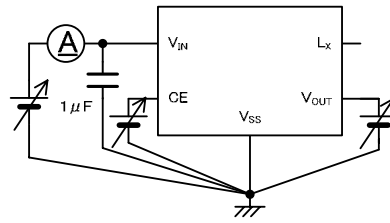

※ External Components

L : 4.7 μH(NR4018)
C_{EN} : 4.7 μF(ceramic)
C_L : 10 μF(ceramic)

< Circuit No.3 >

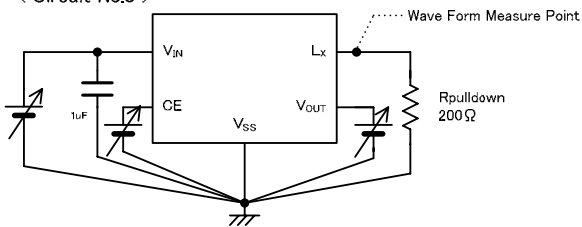

< Circuit No.4 >

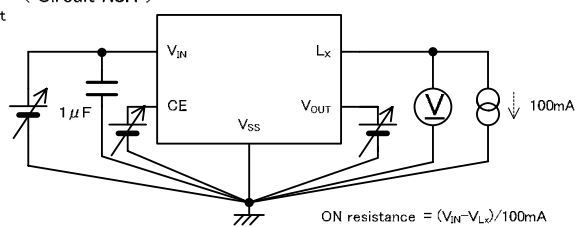

< Circuit No.5 >

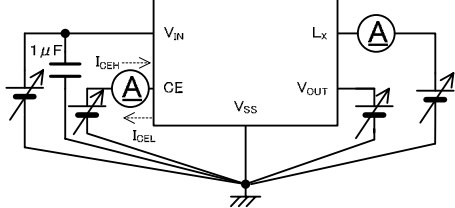

< Circuit No.6 >

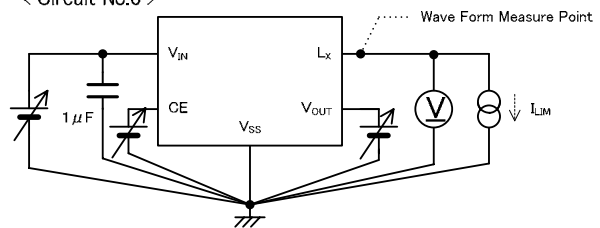

< Circuit No.7 >

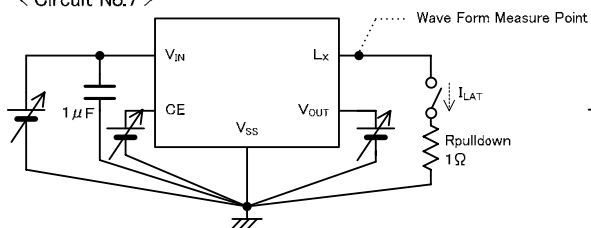

< Circuit No.8 >

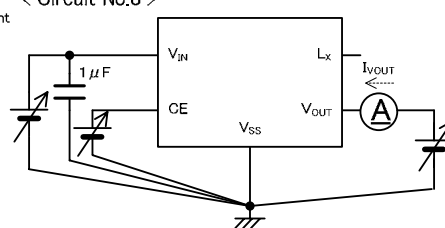

TYPICAL PERFORMANCE CHARACTERISTICS

(1) Efficiency vs. Output Current (Compare to different coil)

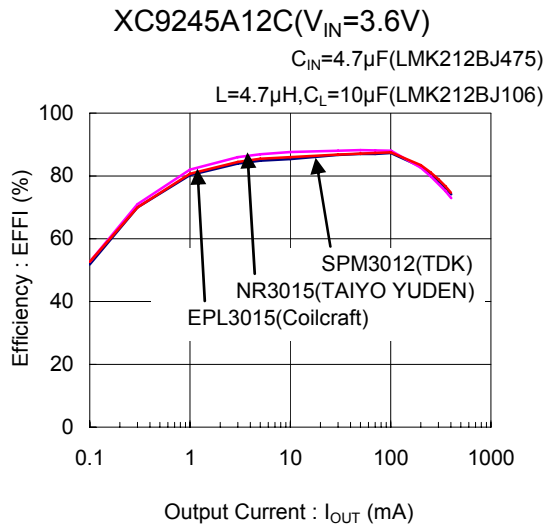
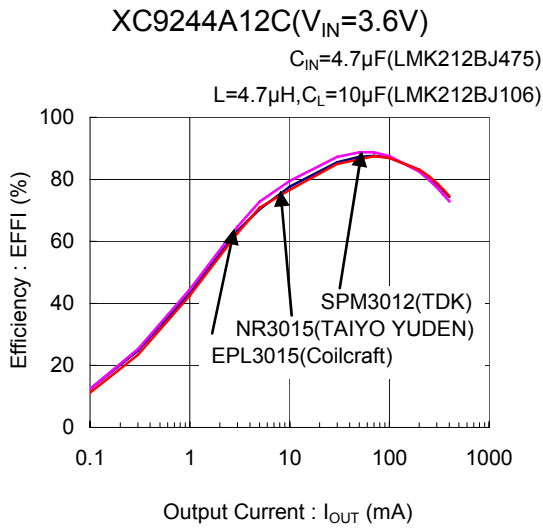

(1) Efficiency vs. Output Current

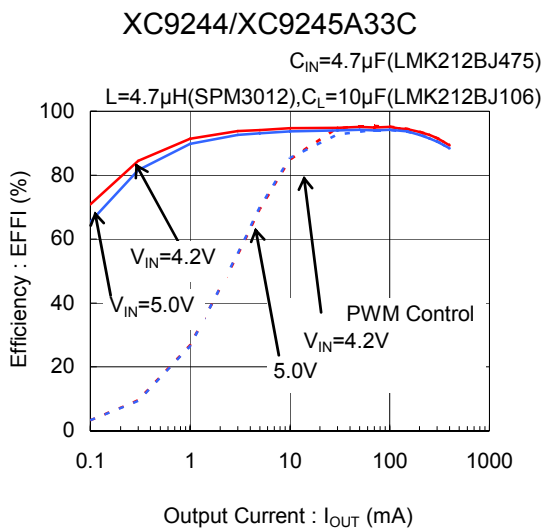
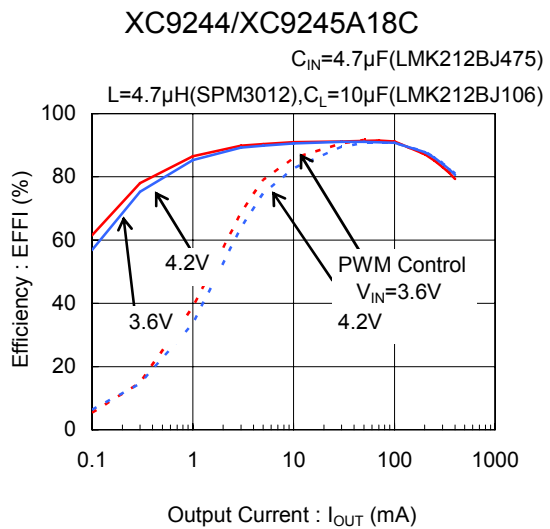
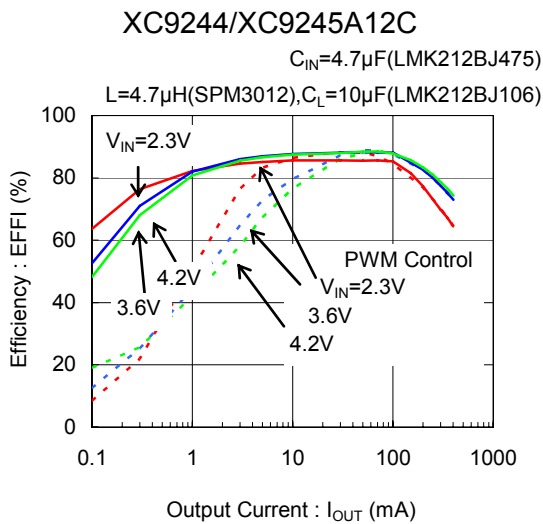

(2) Output Voltage vs. Output Current

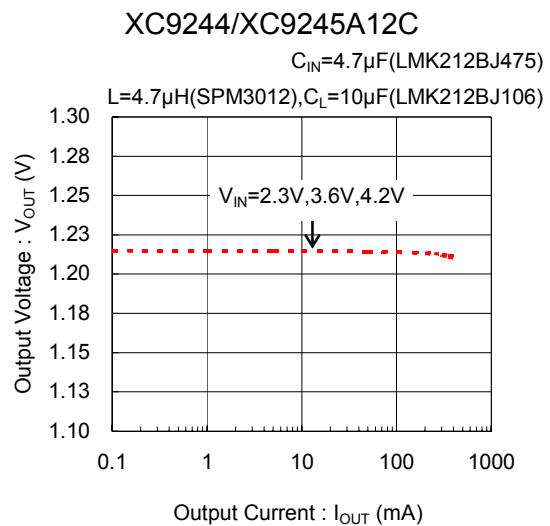

TYPICAL PERFORMANCE CHARACTERISTICS (Continued)

(2) Output Voltage vs. Output Current (Continued)

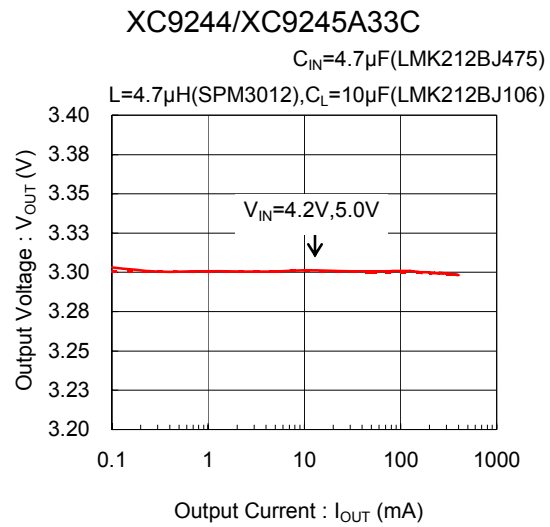
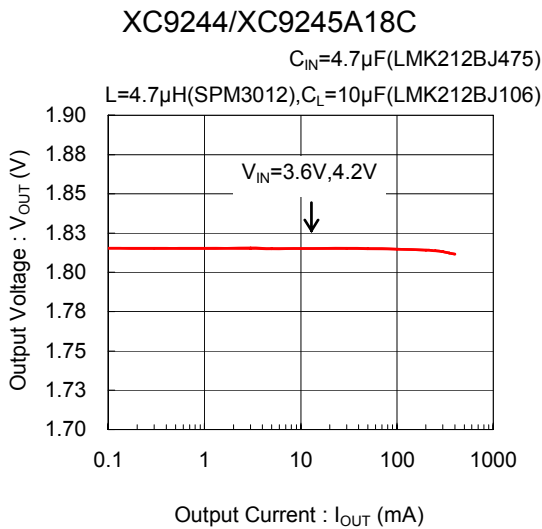

(3) Ripple Voltage vs. Output Current

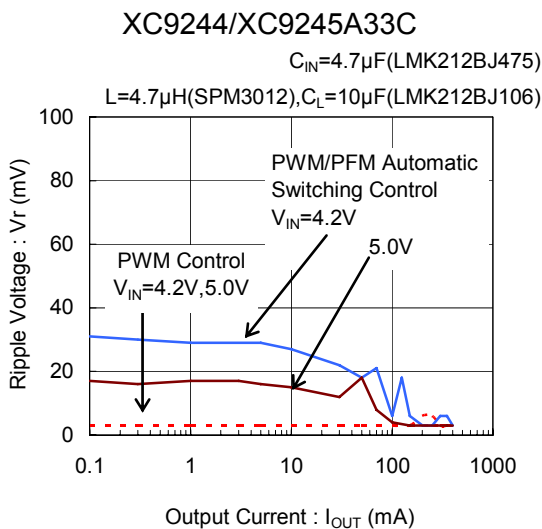
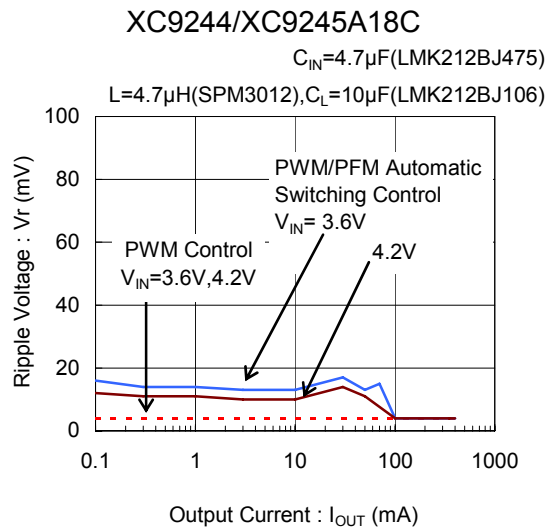
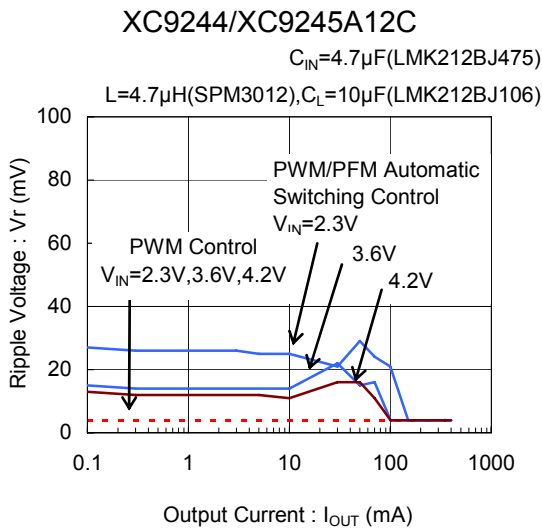

(4) Output Voltage vs. Ambient Temperature

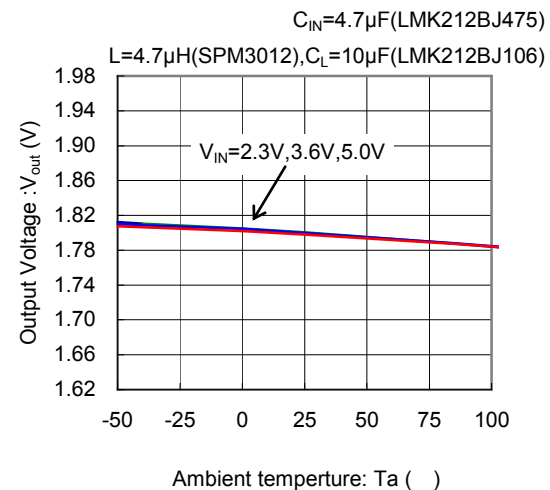

TYPICAL PERFORMANCE CHARACTERISTICS (Continued)

(5) Oscillation Frequency vs. Ambient Temperature

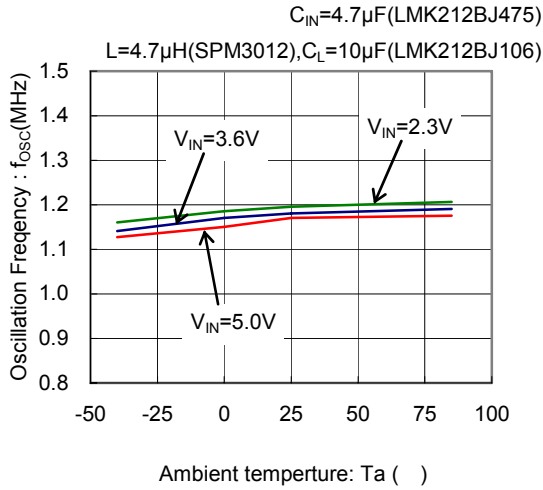

(6) Oscillation Frequency vs. Input Voltage

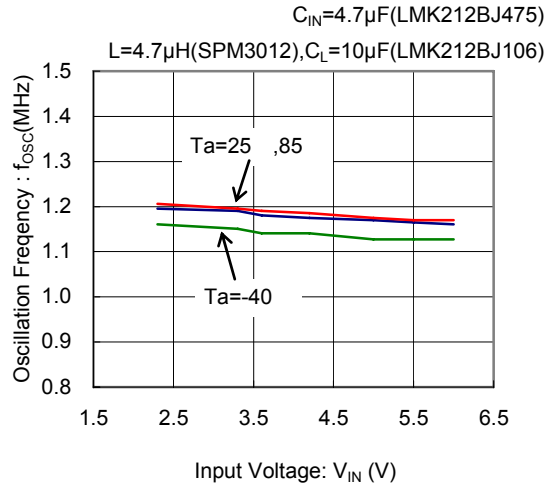

(7) Quiescent Current vs. Ambient Temperature

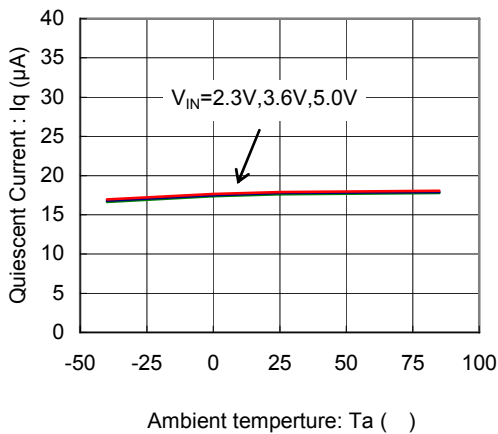

(8) Quiescent Current vs. Input Voltage

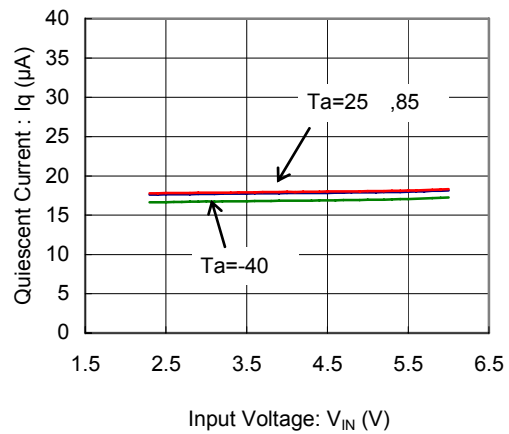

(9) CE "H" Voltage vs. Ambient Temperature

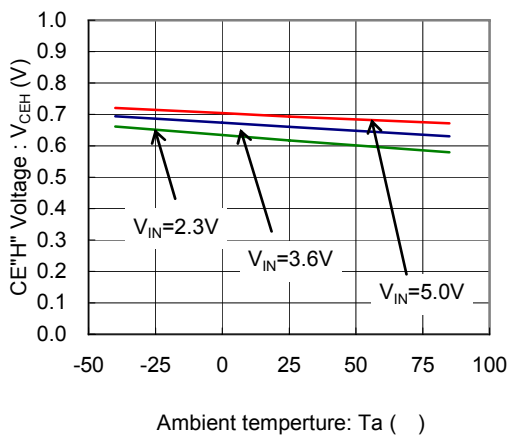

(10) CE "H" Voltage vs. Input Voltage

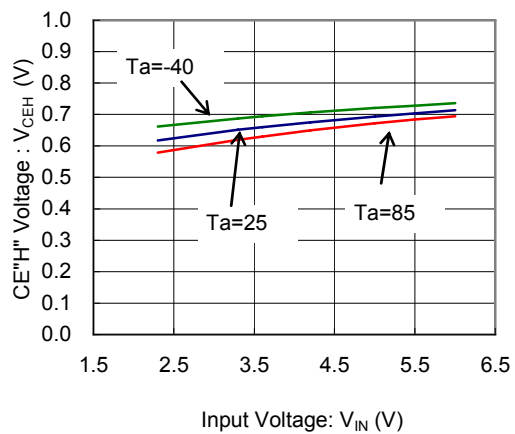

TYPICAL PERFORMANCE CHARACTERISTICS (Continued)

(11) Lx SW "H" ON Resistance vs. Ambient Temperature

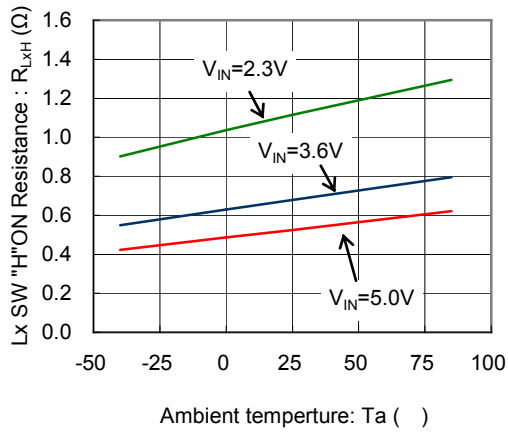

(12) Lx SW "H" ON Resistance vs. Input Voltage

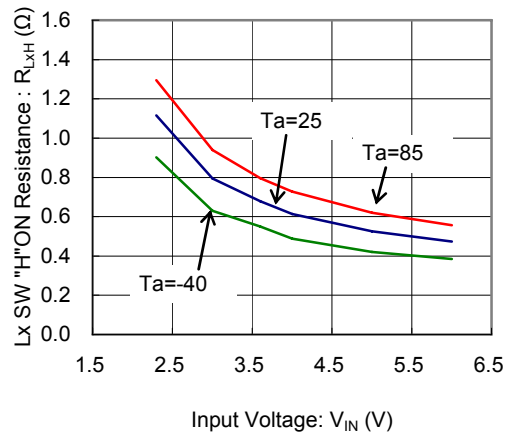

(13) Lx SW "L" ON Resistance vs. Ambient Temperature

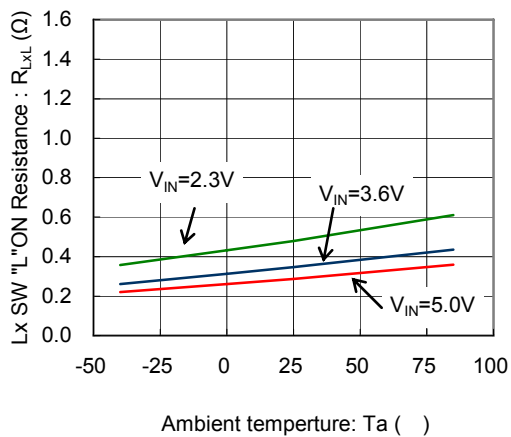

(14) Lx SW "L" ON Resistance vs. Input Voltage

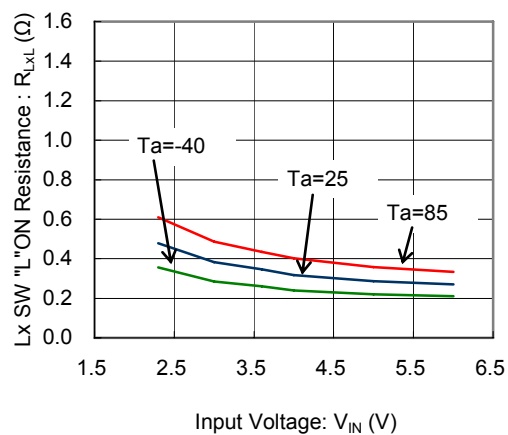

(15) C_L Discharge vs. Ambient Temperature

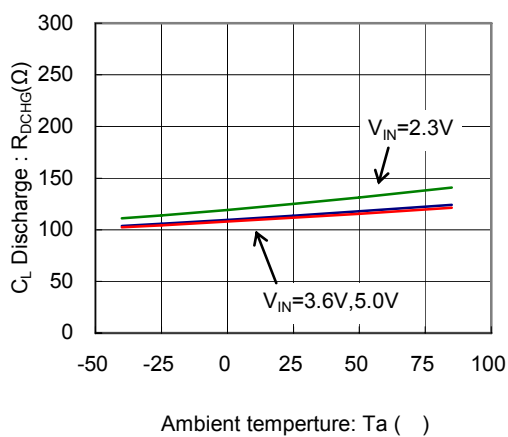

(16) C_L Discharge vs. Input Voltage

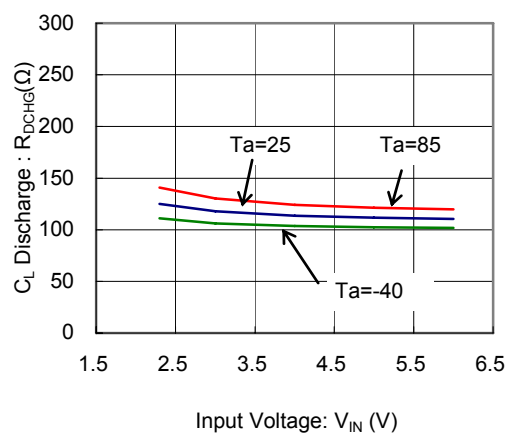

TYPICAL PERFORMANCE CHARACTERISTICS (Continued)

(17) PFM Switch Current vs. Ambient Temperature

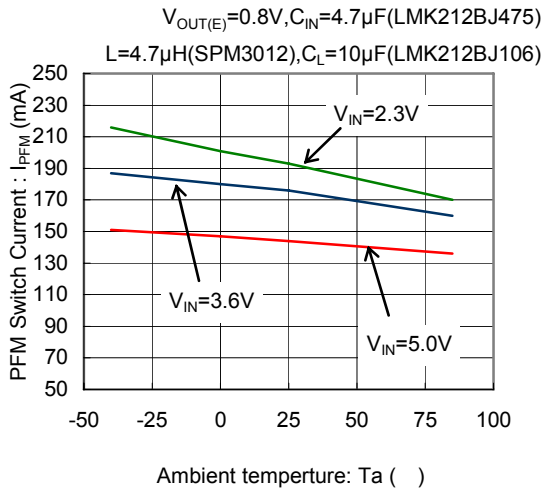

(18) PFM Switch Current vs. Input Voltage

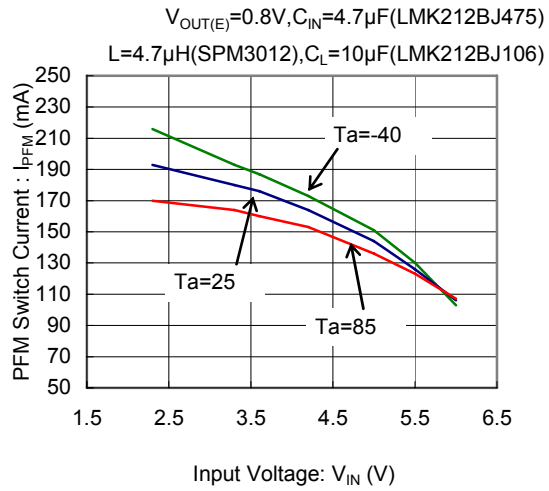

(19) Current Limit vs. Ambient Temperature

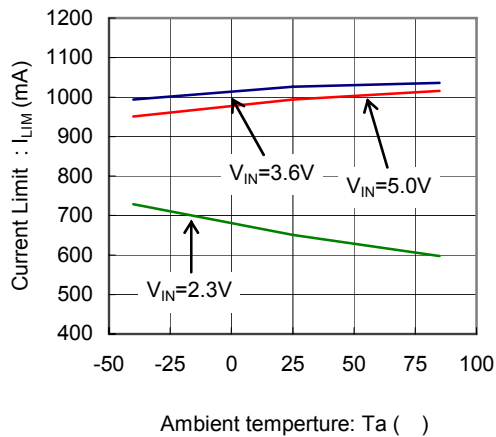

(20) Current Limit vs. Input Voltage

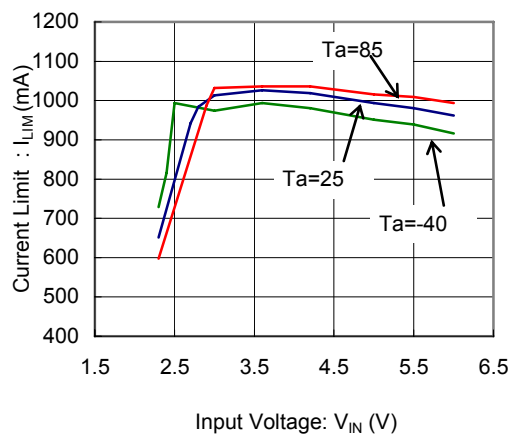

(21) UVLO Voltage vs. Ambient Temperature

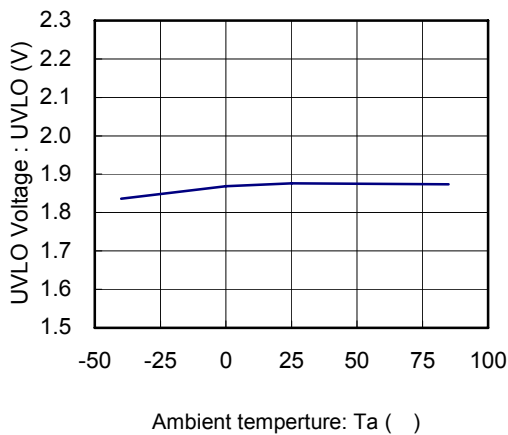

(22) Soft Start Time vs. Input Voltage

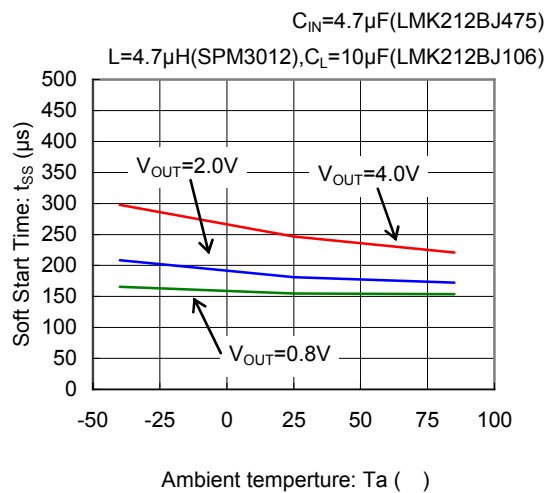

TYPICAL PERFORMANCE CHARACTERISTICS (Continued)

(23) Rise Wave Form

XC9244/XC9245A12C

$C_{IN}=4.7\mu\text{F}$ (LMK212BJ475)

$L=4.7\mu\text{H}$ (SPM3012), $C_L=10\mu\text{F}$ (LMK212BJ106)

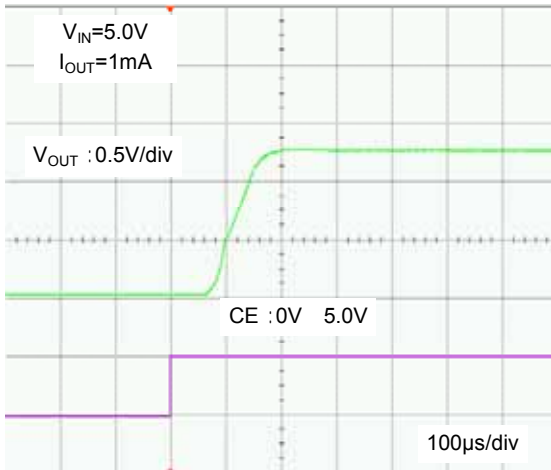

XC9244/XC9245A18C

$C_{IN}=4.7\mu\text{F}$ (LMK212BJ475)

$L=4.7\mu\text{H}$ (SPM3012), $C_L=10\mu\text{F}$ (LMK212BJ106)

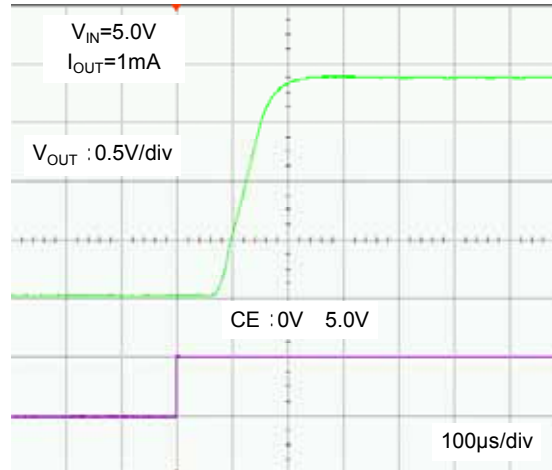

XC9244/XC9245A33C

$C_{IN}=4.7\mu\text{F}$ (LMK212BJ475)

$L=4.7\mu\text{H}$ (SPM3012), $C_L=10\mu\text{F}$ (LMK212BJ106)

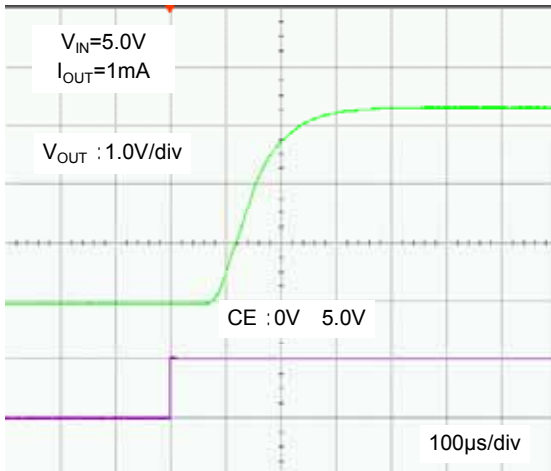

TYPICAL PERFORMANCE CHARACTERISTICS (Continued)

(24) Load Transient Response

XC9244A18C

$C_{IN}=4.7\mu F$ (LMK212BJ475)

$L=4.7\mu H$ (SPM3012), $C_L=10\mu F$ (LMK212BJ106)

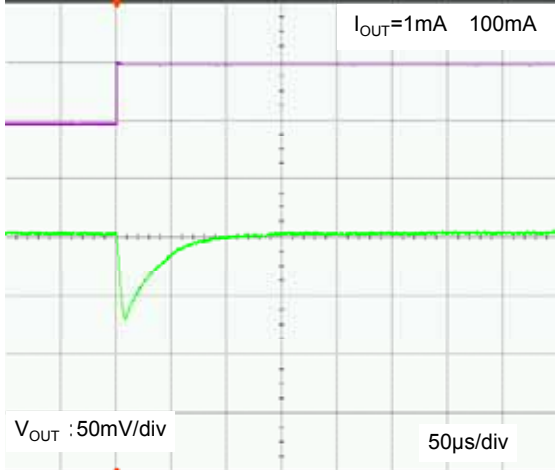

XC9244A18C

$C_{IN}=4.7\mu F$ (LMK212BJ475)

$L=4.7\mu H$ (SPM3012), $C_L=10\mu F$ (LMK212BJ106)

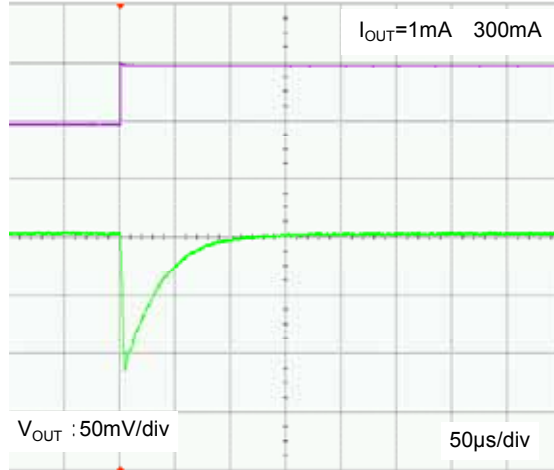

XC9244A18C

$C_{IN}=4.7\mu F$ (LMK212BJ475)

$L=4.7\mu H$ (SPM3012), $C_L=10\mu F$ (LMK212BJ106)

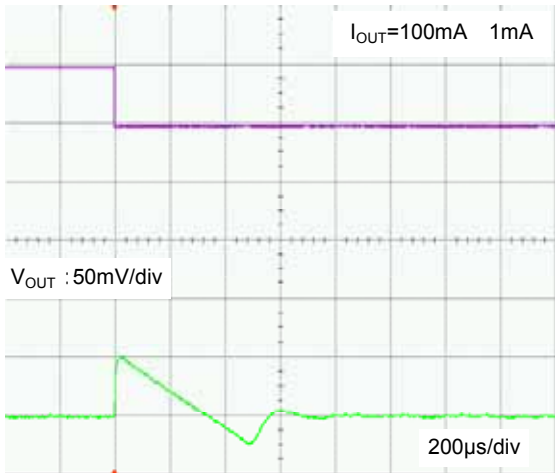

XC9244A18C

$C_{IN}=4.7\mu F$ (LMK212BJ475)

$L=4.7\mu H$ (SPM3012), $C_L=10\mu F$ (LMK212BJ106)

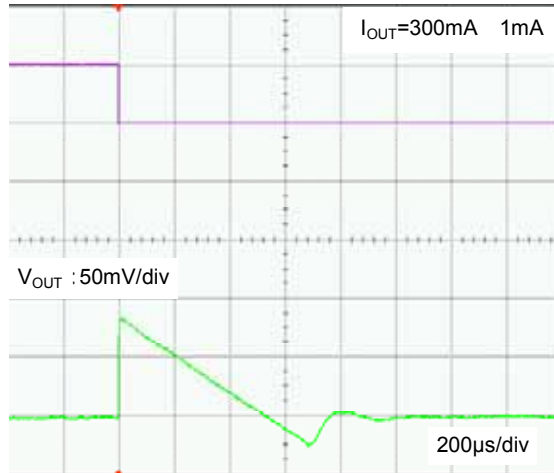

TYPICAL PERFORMANCE CHARACTERISTICS (Continued)

(24) Load Transient Response (Continued)

XC9245A18C

$C_{IN}=4.7\mu\text{F}$ (LMK212BJ475)

$L=4.7\mu\text{H}$ (SPM3012), $C_L=10\mu\text{F}$ (LMK212BJ106)

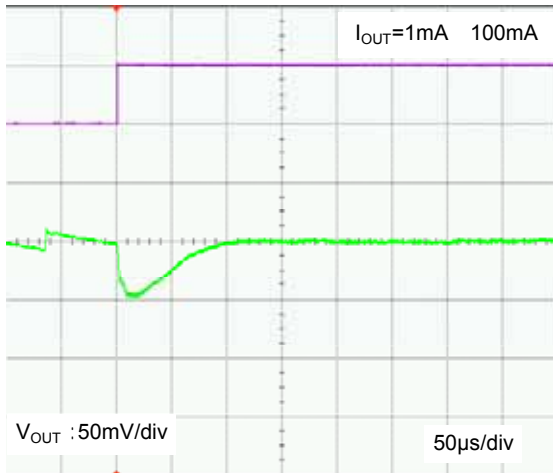

XC9245A18C

$C_{IN}=4.7\mu\text{F}$ (LMK212BJ475)

$L=4.7\mu\text{H}$ (SPM3012), $C_L=10\mu\text{F}$ (LMK212BJ106)

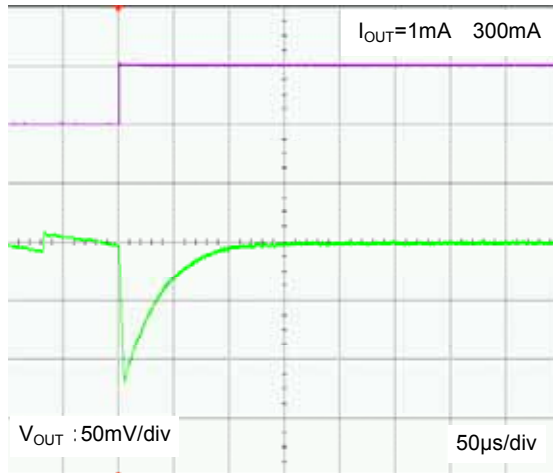

XC9245A18C

$C_{IN}=4.7\mu\text{F}$ (LMK212BJ475)

$L=4.7\mu\text{H}$ (SPM3012), $C_L=10\mu\text{F}$ (LMK212BJ106)

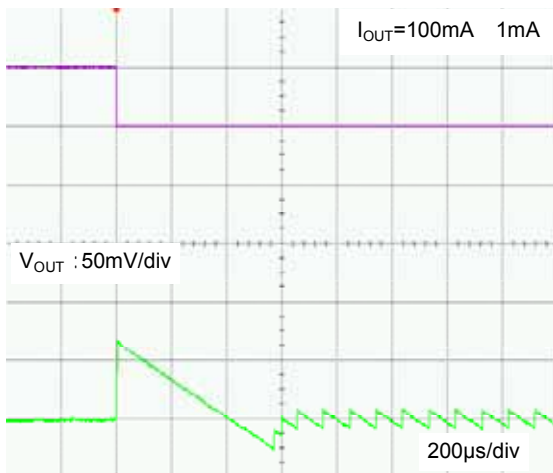

XC9245A18C

$C_{IN}=4.7\mu\text{F}$ (LMK212BJ475)

$L=4.7\mu\text{H}$ (SPM3012), $C_L=10\mu\text{F}$ (LMK212BJ106)

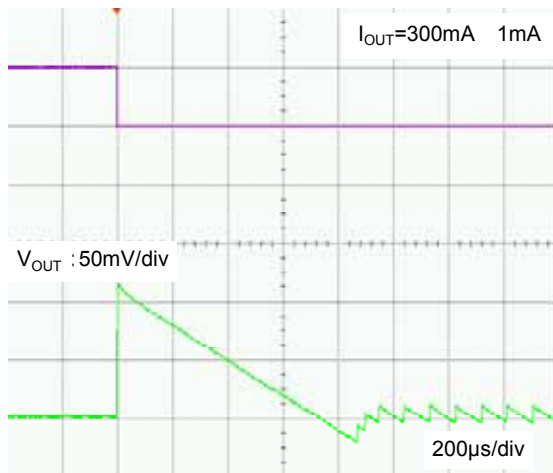

PACKAGING INFORMATION

USPN-6

(unit : mm)

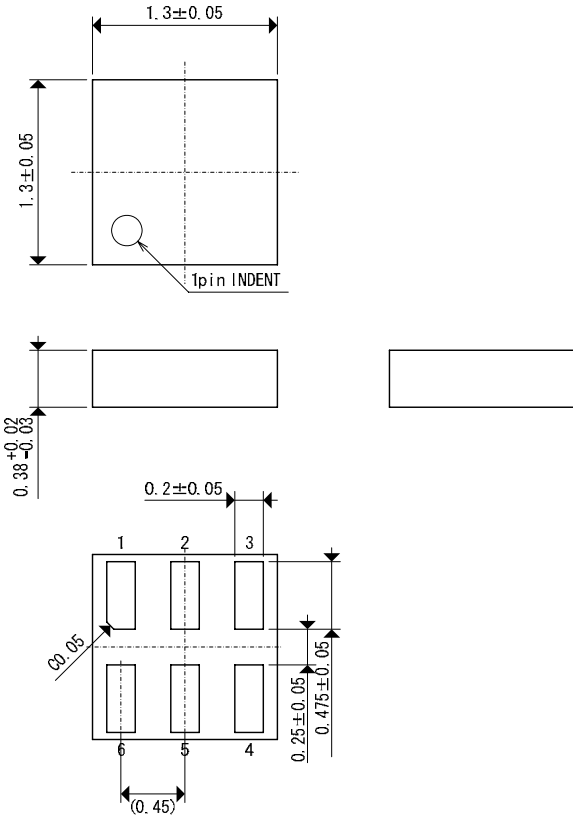

USPN-6 Reference Pattern Layout

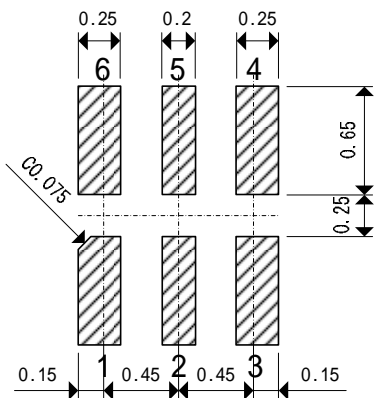

USPN-6 Reference Metal Mask Design

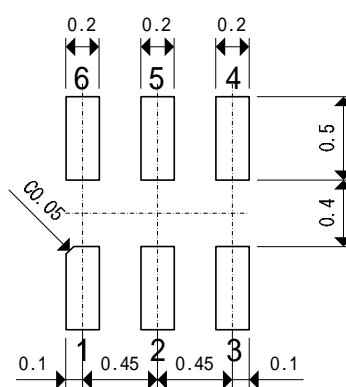

MARKING RULE

represents product series and output voltage

XC9244 Series

USPN-6

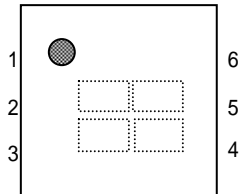

MARK	OUTPUT VOLTAGE	VOLTAGE INCREMENT	PRODUCT SERIES
A	0.8 ~ 3.7	0.1	XC9244A08C**-G ~ XC9244A37C**-G
B	0.85 ~ 3.75	0.05	XC9244A0LC**-G ~ XC9244A3KC**-G
C	3.8 ~ 4.0	0.1	XC9244A38C**-G ~ XC9244A40C**-G
C	3.85 ~ 3.95	0.05	XC9244A3LC**-G ~ XC9244A3MC**-G

XC9245 Series

MARK	OUTPUT VOLTAGE	VOLTAGE INCREMENT	PRODUCT SERIES
D	0.8 ~ 3.7	0.1	XC9245A08C**-G ~ XC9245A37C**-G
E	0.85 ~ 3.75	0.05	XC9245A0LC**-G ~ XC9245A3KC**-G
F	3.8 ~ 4.0	0.1	XC9245A38C**-G ~ XC9245A40C**-G
F	3.85 ~ 3.95	0.05	XC9245A3LC**-G ~ XC9245A3MC**-G

represents product function

MARK	OUTPUT VOLTAGE		MARK	OUTPUT VOLTAGE		
0	0.8	0.85	F	2.3	2.35	
1	0.9	0.95	H	2.4	2.45	
2	1.0	1.05	K	2.5	2.55	
3	1.1	1.15	L	2.6	2.65	
4	1.2	1.25	M	2.7	2.75	
5	1.3	1.35	N	2.8	2.85	
6	1.4	1.45	P	2.9	2.95	
7	1.5	1.55	R	3.0	3.05	
8	1.6	1.65	S	3.1	3.15	
9	1.7	1.75	T	3.2	3.25	
A	1.8	1.85	3.8	U	3.3	3.35
B	1.9	1.95	3.9	V	3.4	3.45
C	2.0	2.05	4.0	X	3.5	3.55
D	2.1	2.15	3.85	Y	3.6	3.65
E	0.8	0.85	3.95	Z	3.7	3.75

represents production lot number

01 to 09, 0A to 0Z, 11 to 9Z, AA to AZ, B1 to ZZ repeated.

(G, I, J, O, Q, W excluded)

*No character inversion used.

1. The products and product specifications contained herein are subject to change without notice to improve performance characteristics. Consult us, or our representatives before use, to confirm that the information in this datasheet is up to date.
2. We assume no responsibility for any infringement of patents, patent rights, or other rights arising from the use of any information and circuitry in this datasheet.
3. Please ensure suitable shipping controls (including fail-safe designs and aging protection) are in force for equipment employing products listed in this datasheet.
4. The products in this datasheet are not developed, designed, or approved for use with such equipment whose failure or malfunction can be reasonably expected to directly endanger the life of, or cause significant injury to, the user.
(e.g. Atomic energy; aerospace; transport; combustion and associated safety equipment thereof.)
5. Please use the products listed in this datasheet within the specified ranges.
Should you wish to use the products under conditions exceeding the specifications, please consult us or our representatives.
6. We assume no responsibility for damage or loss due to abnormal use.
7. All rights reserved. No part of this datasheet may be copied or reproduced without the prior permission of TOREX SEMICONDUCTOR LTD.

TOREX SEMICONDUCTOR LTD.

单击下面可查看定价，库存，交付和生命周期等信息

[>>Torex Semiconductor\(特瑞仕\)](#)