

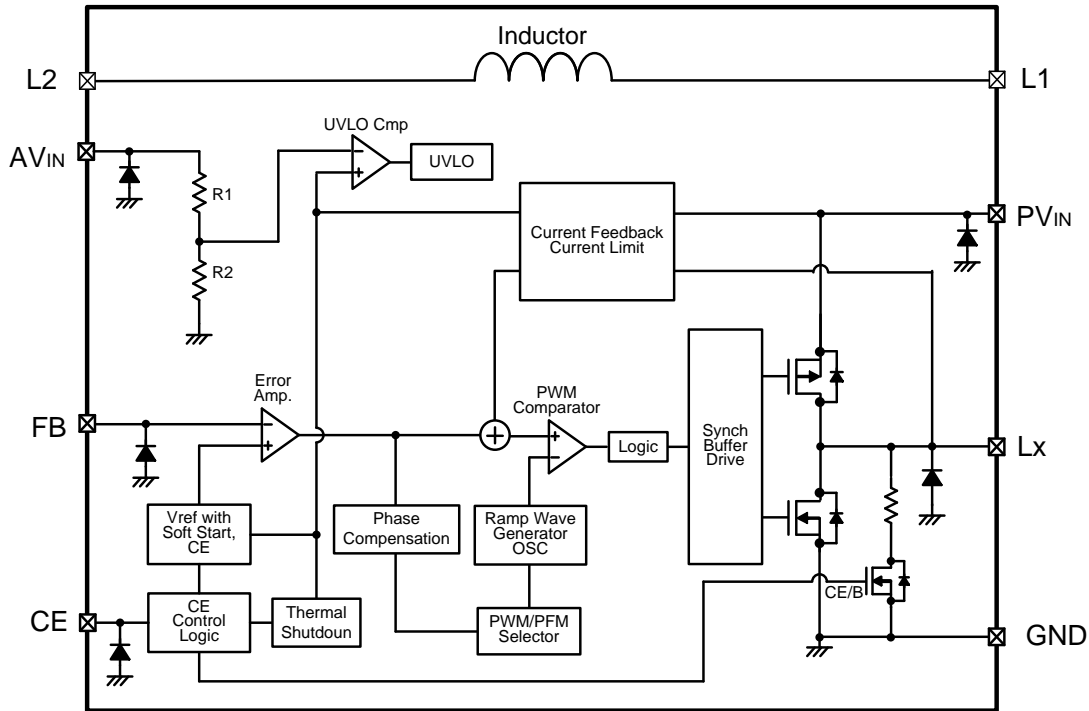

## ■ BLOCK DIAGRAM

XCL211/XCL212 Series (USP-11B01)



\* The XCL211 offers a fixed PWM control, a Control Logic of PWM/PFM Selector is fixed at "PWM" internally. The XCL212 control scheme is a fixed PWM/PFM automatic switching, a Control Logic of PWM/PFM Selector is fixed at "PWM/PFM automatic switching" internally. Diodes inside the circuit are an ESD protection diode and a parasitic diode.

## ■ PRODUCT CLASSIFICATION

### ● Ordering Information

XCL211①②③④⑤⑥

Fixed PWM

XCL212①②③④⑤⑥

PWM/PFM Auto Switching

| DESIGNATOR | ITEM                  | SYMBOL | DESCRIPTION                        |
|------------|-----------------------|--------|------------------------------------|
| ①          | Type                  | B      | Refer to Selection Guide           |
| ②③         | Reference Voltage     | 08     | Reference Voltage is fixed at 0.8V |
| ④          | Oscillation Frequency | 2      | 2.4MHz                             |
| ⑤⑥ (*1)    | Package (Order Unit)  | DR     | USP-11B01 (*2) (1,000pcs/Reel)     |

(\*1) Halogen free and EU RoHS compliant.

(\*2) The USP-11B01 reels are shipped in a moisture-proof packing.

### ● Selection Guide

| TYPE | SOFT-START TIME | CHIP ENABLE | CURRENT LIMITER | THERMAL SHUTDOWN | UVLO | CL AUTO-DISCHARGE |
|------|-----------------|-------------|-----------------|------------------|------|-------------------|
| B    | Fixed           | Yes         | Yes             | Yes              | Yes  | Yes               |

## PIN CONFIGURATION

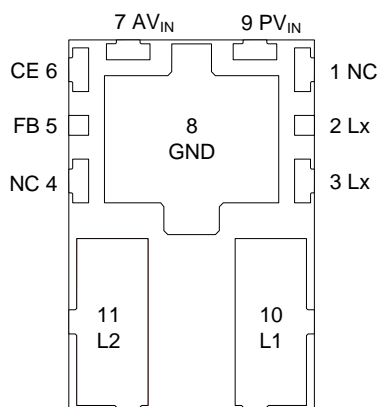

USP-11B01  
(BOTTOM VIEW)

- \* Please connect the AV<sub>IN</sub> pin (No.7) and the PV<sub>IN</sub> pin (No.9) when operating.
- \* Please connect the L<sub>x</sub> pins (No.2 and No.3).

## PIN ASSIGNMENT

| PIN NUMBER | PIN NAME         | FUNCTIONS              |
|------------|------------------|------------------------|
| 1          | NC               | No Connection          |
| 2          | Lx               | Switching Output       |
| 3          | Lx               | Switching Output       |
| 4          | NC               | No Connection          |
| 5          | FB               | Output Voltage Monitor |
| 6          | CE               | Chip Enable            |
| 7          | AV <sub>IN</sub> | Analog Input           |
| 8          | GND              | Ground                 |
| 9          | PV <sub>IN</sub> | Power Input            |
| 10         | L1               | Inductor Electrodes    |
| 11         | L2               | Inductor Electrodes    |

## CE PIN FUNCTION

| PIN NAME | SIGNAL | STATUS   |
|----------|--------|----------|
| CE       | Low    | Stand-by |
|          | High   | Active   |

\* Please do not leave the CE pin open.

## ABSOLUTE MAXIMUM RATINGS

| Ta=25°C                       |                   |  |   |
|-------------------------------|-------------------|--|---|
| PARAMETER                     | SYMBOL            | RATINGS  | UNIT  |
| PVIN Pin Voltage              | V <sub>PVIN</sub> | -0.3 ~ +7.0 <sup>(1)</sup>                           | V   |
| AVIN Pin Voltage              | V <sub>AVIN</sub> |  |   |
| CE Pin Voltage                | V <sub>CE</sub>   | -0.3 ~ +7.0  | V   |
| FB Pin Voltage                | V <sub>FB</sub>   | -0.3 ~ +7.0  | V   |
| Lx Pin Voltage                | V <sub>Lx</sub>   | -0.3 ~ +7.0 or V <sub>PVIN</sub> +0.3 <sup>(2)</sup> | V   |
| Lx Pin Current                | I <sub>Lx</sub>   | ±6.0 <sup>(3)</sup>                                  | A   |
| Power Dissipation             | USP-11B01         | P <sub>d</sub>                                       | 1000(40mm x 40mm Standard board) <sup>(4)</sup> |
| Operating Ambient Temperature | T <sub>opr</sub>  | -40 ~ +85  | °C  |
| Storage Temperature           | T <sub>stg</sub>  | -55 ~ +125   | °C  |

All voltages are described based on the ground voltage of GND.

<sup>(1)</sup> Please connect PV<sub>IN</sub> pin (No.9) and AV<sub>IN</sub> pin (No.7) for use.

<sup>(2)</sup> The maximum value should be either +7.0 or V<sub>PVIN</sub>+0.3 in the lowest.

<sup>(3)</sup> It is measured when the two L<sub>x</sub> pins (No.2 and 3) are tied up to each other.

<sup>(4)</sup> The power dissipation figure shown is PCB mounted and is for reference only.

Please see the power dissipation page for the mounting condition.

## ELECTRICAL CHARACTERISTICS

XCL211B082DR/XCL212B082DR,

Ta=25°C

| PARAMETER                                  | SYMBOL   | CONDITIONS   | MIN.  | TYP.  | MAX.            | UNIT   | CIRCUIT |
|--|--|--|-------|-------|-----------------|--------|---------|
| FB Voltage                                 | V <sub>FB</sub>  | V <sub>IN</sub> =5.0V, V <sub>CE</sub> =5.0V<br>Voltage to start oscillation while<br>V <sub>FB</sub> =0.72V → 0.88V | 0.784 | 0.800 | 0.816           | V      | ③       |
| Operating Voltage Range                    | V <sub>IN</sub>  | When connected to external components  | 2.7   | -     | 6.0             | V      | ①       |
| Maximum Output Current                     | I <sub>OUTMAX</sub>  | V <sub>IN</sub> =V <sub>CE</sub> =5.0V (*1,*2)<br>When connected to external components                              | 2.0   | -     | -               | A      | ①       |
| UVLO Voltage                               | V <sub>UVLO</sub>  | V <sub>CE</sub> =5.0V, V <sub>FB</sub> =0.72V<br>Voltage which Lx pin holding "L" level (*3)                         | 2.00  | -     | 2.68            | V      | ③       |
| Quiescent Current                          | I <sub>q</sub>   | V <sub>IN</sub> =V <sub>CE</sub> =5.0V, V <sub>FB</sub> =0.88V   | -     | 53    | 92              | μA     | ②       |
| Stand-by Current                           | I <sub>STB</sub>   | V <sub>IN</sub> =5.0V, V <sub>CE</sub> =0V, V <sub>FB</sub> =0.88V   | -     | 0.01  | 1.00            | μA     | ②       |
| Oscillation Frequency                      | f <sub>OSC</sub>   | V <sub>IN</sub> =V <sub>CE</sub> =5.0V, I <sub>OUT</sub> =300mA<br>When connected to external components             | 2040  | 2400  | 2760            | kHz    | ①       |
| PFM Switch Current (*4)                    | I <sub>PFM</sub>   | V <sub>IN</sub> =V <sub>CE</sub> =6.0V, I <sub>OUT</sub> =1mA<br>When connected to external components               | -     | 680   | -               | mA     | ①       |
| PFM Duty Limit (*4)                        | DTY <sub>LIMIT_PFM</sub>                                   | V <sub>IN</sub> =V <sub>CE</sub> =2.7V, I <sub>OUT</sub> =1mA<br>When connected to external components               | -     | 180   | 250             | %      | ①       |
| Maximum Duty Cycle                         | D <sub>MAX</sub>   | V <sub>IN</sub> =V <sub>CE</sub> =5.0V, V <sub>FB</sub> =0.72V   | 100   | -     | -               | %      | ③       |
| Minimum Duty Cycle                         | D <sub>MIN</sub>   | V <sub>IN</sub> =V <sub>CE</sub> =5.0V, V <sub>FB</sub> =0.88V   | -     | -     | 0               | %      | ③       |
| LXSW"H"ON Resistance                       | R <sub>LXH</sub>   | V <sub>IN</sub> =V <sub>CE</sub> =4.0V, V <sub>FB</sub> =0.72V (*5)  | -     | 0.11  | 0.21            | Ω      | ④       |
| LXSW"L"ON Resistance                       | R <sub>LXL</sub>   |  | -     | 0.12  | 0.30 (*6)       | Ω      | -       |
| LXSW"H" Leakage Current                    | I <sub>LeakH</sub>   | V <sub>IN</sub> =5.0V, V <sub>CE</sub> =0V, V <sub>FB</sub> =0.88V, V <sub>Lx</sub> =0V                              | -     | 0.01  | 1.00 (*7)       | μA     | ⑤       |
| Current Limit                              | I <sub>LIM</sub>   | V <sub>IN</sub> =V <sub>CE</sub> =5.0V, V <sub>FB</sub> =0.72V (*8)  | -     | 4.0   | -               | A      | ④       |
| Output Voltage Temperature Characteristics | ΔV <sub>OUT</sub> / (ΔT <sub>opr</sub> ·V <sub>OUT</sub> ) | I <sub>OUT</sub> =100mA<br>-40°C ≤ T <sub>opr</sub> ≤ 85°C<br>When connected to external components                  | -     | ±100  | -               | ppm/°C | ①       |
| CE "H" Voltage                             | V <sub>CEH</sub>   | V <sub>IN</sub> =5.0V, V <sub>FB</sub> =0.72V Applied voltage to V <sub>CE</sub><br>Voltage changes Lx to "H" level  | 1.2   | -     | V <sub>IN</sub> | V      | ③       |
| CE "L" Voltage                             | V <sub>CEL</sub>   | V <sub>IN</sub> =5.0V, V <sub>FB</sub> =0.72V Applied voltage to V <sub>CE</sub><br>Voltage changes Lx to "L" level  | GND   | -     | 0.4             | V      | ③       |
| CE "H" Current                             | I <sub>CEH</sub>   | V <sub>IN</sub> =5.0V, V <sub>CE</sub> =5.0V, V <sub>FB</sub> =0V  | -0.1  | -     | 0.1             | μA     | ⑤       |
| CE "L" Current                             | I <sub>CEL</sub>   | V <sub>IN</sub> =5.0V, V <sub>CE</sub> =0V, V <sub>FB</sub> =0V  | -0.1  | -     | 0.1             | μA     | ⑤       |
| FB "H" Current                             | I <sub>FBH</sub>   | V <sub>IN</sub> =5.0V, V <sub>CE</sub> =0V, V <sub>FB</sub> =5.0V  | -0.1  | -     | 0.1             | μA     | ⑤       |
| FB "L" Current                             | I <sub>FBL</sub>   | V <sub>IN</sub> =5.0V, V <sub>CE</sub> =0V, V <sub>FB</sub> =0V  | -0.1  | -     | 0.1             | μA     | ⑤       |
| Soft-Start Time                            | t <sub>SS</sub>  | V <sub>IN</sub> =5.0V, V <sub>CE</sub> =0V → 5.0V, I <sub>OUT</sub> =1mA<br>When connected to external components    | 0.3   | 1.0   | 2.0             | ms     | ①       |
| Thermal Shutdown Temperature               | T <sub>TSD</sub>   |  | -     | 150   | -               | °C     | -       |
| Hysteresis Width                           | T <sub>HYS</sub>   |  | -     | 20    | -               | °C     | -       |
| C <sub>L</sub> Discharge Resistance        | R <sub>DCHG</sub>  | V <sub>IN</sub> =5.0V, V <sub>CE</sub> =0V, V <sub>FB</sub> =0.72V, V <sub>Lx</sub> =1.0V                            | 80    | 130   | 160             | Ω      | ⑥       |
| Inductance                                 | L  | Test Freq.=1.0MHz  | -     | 1.5   | -               | μH     | -       |
| Inductor Rated Current                     | I <sub>DC</sub>  | ΔT=+40°C   | -     | 2.3   | -               | A      | -       |

External Components: C<sub>IN1</sub>=20μF(ceramic), C<sub>IN2</sub>=1μF(ceramic), C<sub>L</sub>=20μF(ceramic), R1=15kΩ, R2=30kΩ, C<sub>FB</sub>=1000pF

Condition: Unless otherwise stated, "H"= V<sub>IN</sub> - V<sub>IN</sub> - 1.2V, "L"= + 0.1V ~ -0.1V

(\*1) Mount conditions affect heat dissipation. Maximum output current is not guaranteed when T<sub>TSD</sub> starts to operate earlier.

(\*2) When the difference between the input and the output is small, some cycles may be skipped completely before current maximizes.

If current is further pulled from this state, output voltage will decrease because of P-ch driver ON resistance.

(\*3) These values include UVLO detect voltage, UVLO release voltage and hysteresis operating voltage range.

UVLO release voltage is defined as the V<sub>IN</sub> voltage which makes Lx pin "H".

(\*4) XCL211 series exclude I<sub>PFM</sub> and DTY<sub>LIMIT\_PFM</sub> because those are only for the PFM control's functions.

(\*5) On resistance = (V<sub>IN</sub> - Lx pin measurement voltage) / 0.1A

(\*6) Design value

(\*7) When temperature is high, a current of approximately 20μA (maximum) may leak.

(\*8) Current limit denotes the level of detection at peak of coil current.

## TEST CIRCUITS

< Circuit No.① >

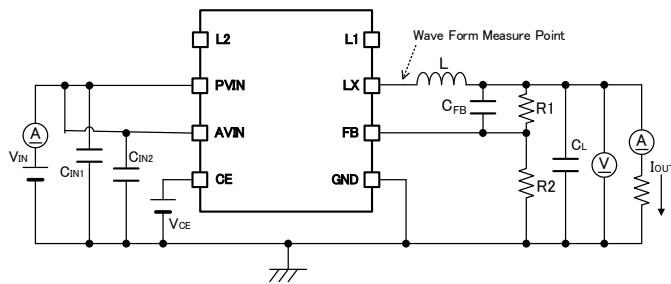

※External Components  
 $C_{IN1}$  : 20  $\mu$ F (ceramic)  
 $C_{IN2}$  : 1  $\mu$ F (ceramic)  
 $C_L$  : 20  $\mu$ F (ceramic)  
 $R_1$  : 15k  $\Omega$   
 $R_2$  : 30k  $\Omega$   
 $C_{FB}$  : 1000pF (ceramic)  
 $L$  : 1.5  $\mu$ H (Selected goods)

< Circuit No.② >

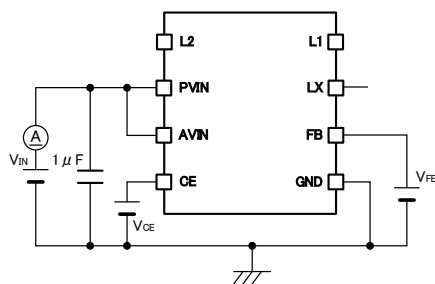

< Circuit No.③ >

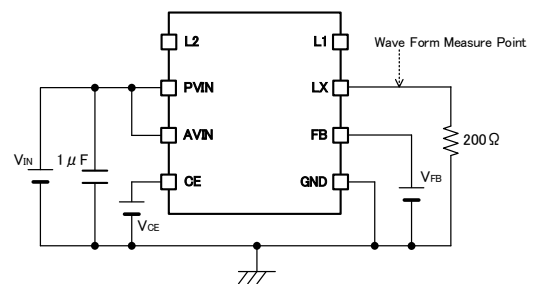

< Circuit No.④ >

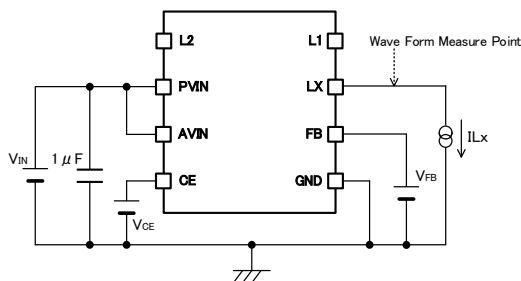

< Circuit No.⑤ >

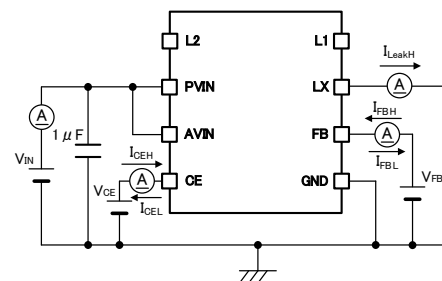

< Circuit No.⑥ >

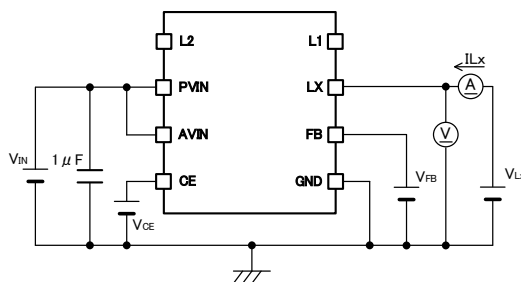

## TYPICAL APPLICATION CIRCUIT

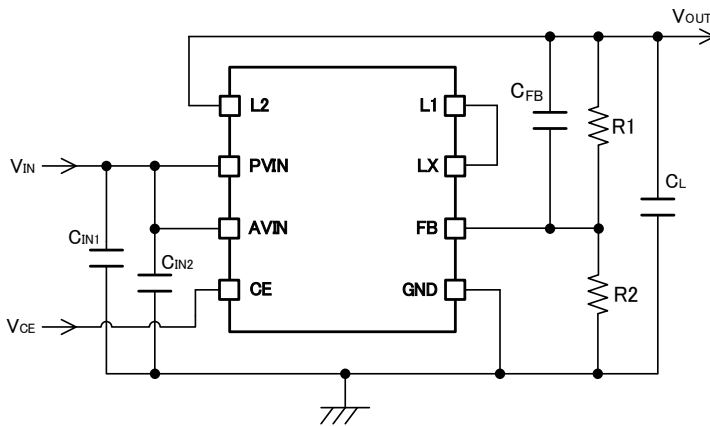

**NOTE:**

The integrated Inductor can be used only for this DC/DC converter. Please do not use this inductor for other reasons.

**【External Components】**

|                                    | VALUE    | PRODUCT NUMBER              |
|------------------------------------|----------|-----------------------------|
| C <sub>IN1</sub><br>C <sub>L</sub> | 10V/10μF | LMK212ABJ106KG (TaiyoYuden) |
|                                    |          | LMK212AB7106MG (TaiyoYuden) |
|                                    |          | C2012JB1A106K125AC (TDK)    |
|                                    |          | C2012X7R1A106K125AC (TDK)   |
|                                    | 10V/22μF | LMK212BBJ226MG (TaiyoYuden) |
|                                    |          | C2012JB1A226M125AB (TDK)    |
| C <sub>IN2</sub>                   | 16V/1μF  | EMK107BJ105KA (TaiyoYuden)  |
|                                    |          | EMK107B7105KA (TaiyoYuden)  |
|                                    |          | C1005JB1C105K050BC (TDK)    |
|                                    |          | C1005X5R1C105K050BC (TDK)   |
|                                    |          | C1608X7R1C105K080AC (TDK)   |

**NOTE:**

The minimum value of the C<sub>IN1</sub> should be 10μF, and it is optimum to set a capacitance value depends on the input impedance.

The value of the C<sub>L</sub> should be within the range from 20μF to 47μF.

**<Output Voltage Setting>**

Output voltage can be set by adding external split resistors. Output voltage is determined by the following equation, based on the values of RFB1 and RFB2. The sum of RFB1 and RFB2 should normally be 100kΩ or less. Output voltage range is 0.9V~5.5V by a 0.8V (±2.0%) reference voltage. When input voltage (V<sub>IN</sub>) ≤ setting output voltage, output voltage (V<sub>OUT</sub>) can not output the power more than input voltage (V<sub>IN</sub>).

$$V_{OUT} = 0.8 \times (R1 + R2) / R2$$

The value of C<sub>FB</sub>, speed-up capacitor for phase compensation, should be  $f_{ZFB} = 1 / (2 \times \pi \times CFB \times RFB1)$  which is equal to 20kHz. Adjustments are required from 1kHz to 10kHz depending on the application, value of inductance (L), and value of load capacitance (C<sub>L</sub>).

**[Example of calculation]**

When R<sub>FB1</sub>=47kΩ, R<sub>FB2</sub>=15kΩ,  $V_{OUT} = 0.8 \times (47k\Omega + 15k\Omega) / 15k\Omega = 3.3V$

When C<sub>FB</sub>=330pF,  $f_{zfb} = 1 / (2 \times \pi \times 330pF \times 47k\Omega) = 10.26kHz$

| V <sub>OUT</sub><br>(V) | R <sub>FB1</sub><br>(kΩ) | R <sub>FB2</sub><br>(kΩ) | C <sub>FB</sub><br>(pF) | V <sub>OUT</sub><br>(V) | R <sub>FB1</sub><br>(kΩ) | R <sub>FB2</sub><br>(kΩ) | C <sub>FB</sub><br>(pF) |
|-------------------------|--------------------------|--------------------------|-------------------------|-------------------------|--------------------------|--------------------------|-------------------------|
| 1.0                     | 7.5                      | 30                       | 2000                    | 2.5                     | 51                       | 24                       | 300                     |
| 1.2                     | 15                       | 30                       | 1000                    | 3.0                     | 33                       | 12                       | 470                     |
| 1.5                     | 26                       | 30                       | 560                     | 3.3                     | 47                       | 15                       | 330                     |
| 1.8                     | 30                       | 24                       | 510                     | 5.0                     | 43                       | 8.2                      | 390                     |

## OPERATIONAL DESCRIPTION

The XCL211/XCL212 series consists of a reference voltage source, ramp wave circuit, error amplifier, PWM comparator, phase compensation circuit, output voltage adjustment resistors, P-channel MOS driver transistor, N-channel MOS switching transistor for the synchronous switch, current limiter circuit, UVLO circuit and others. (See the BLOCK DIAGRAM below) The series ICs compare, using the error amplifier, the voltage of the internal voltage reference source with the feedback voltage from the FB pin. Phase compensation is performed on the resulting error amplifier output, to input a signal to the PWM comparator to determine the turn-on time during PWM operation. The PWM comparator compares, in terms of voltage level, the signal from the error amplifier with the ramp wave from the ramp wave circuit, and delivers the resulting output to the buffer driver circuit to cause the Lx pin to output a switching duty cycle. This process is continuously performed to ensure stable output voltage. The current feedback circuit monitors the P-channel MOS driver transistor current for each switching operation, and modulates the error amplifier output signal to provide multiple feedback signals. This enables a stable feedback loop even when a low ESR capacitor such as a ceramic capacitor is used ensuring stable output voltage.

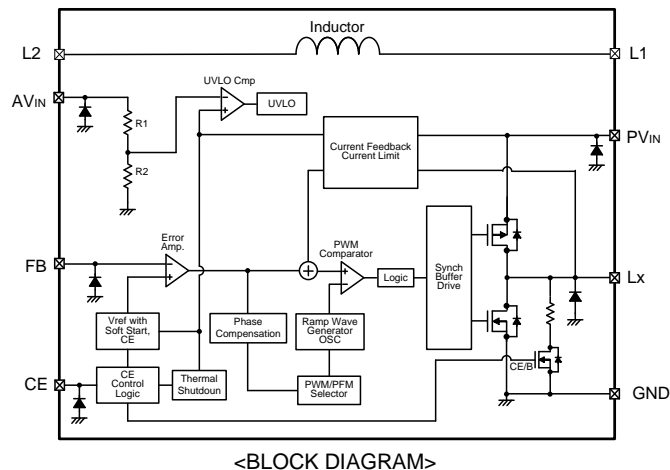

### <Reference Voltage Source>

The reference voltage source provides the reference voltage to ensure stable output voltage of the DC/DC converter.

### <Ramp Wave Circuit>

The ramp wave circuit determines switching frequency. The frequency is fixed internally and can be selected from 1.2MHz or 2.4MHz. Clock pulses generated in this circuit are used to produce ramp waveforms needed for PWM operation, and to synchronize all the internal circuits.

### <Error Amplifier>

The error amplifier is designed to monitor output voltage. The amplifier compares the reference voltage with the feedback voltage divided by the external split resistors, R1 and R2. When a voltage lower than the reference voltage is fed back, the output voltage of the error amplifier increases. The gain and frequency characteristics of the error amplifier output are fixed internally to deliver an optimized signal to the mixer.

### <Current Limit>

The XCL211/XCL212 series includes a fold-back circuit, which aids the operation of the current limiter and circuit protection. The XCL211/XCL212 series monitors the current flowing through the P-channel MOS driver transistor

- ① When current flowing through P-channel MOS driver transistor reaches current limit  $I_{LIM}$ , the current limiter circuit operates to limit the inductor current  $I_{Lx}$ . If this state continues, the fold-back circuit operates and limit the output current in order to protect the IC from damage.
- ② The output voltage is automatically resumed if the load goes light. When it is resumed, the soft-start function operates.

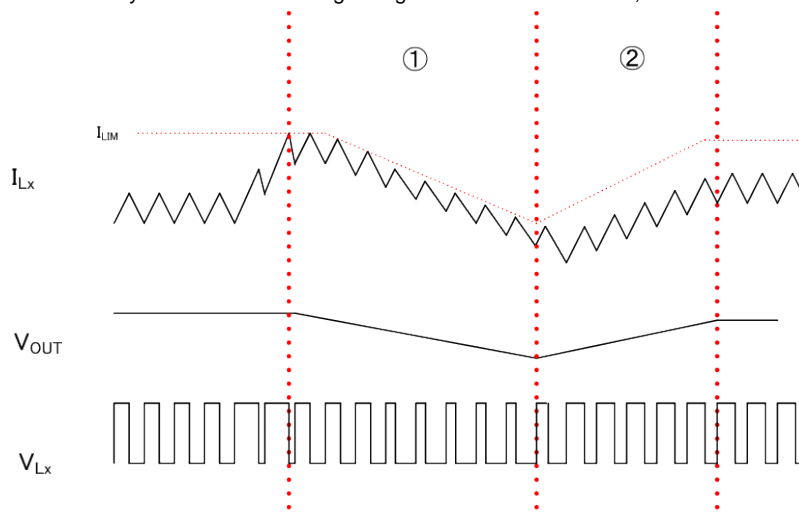

## OPERATIONAL DESCRIPTION (Continued)

### <Thermal Shutdown>

For protection against heat damage, the thermal shutdown function monitors chip temperature. When the chip's temperature reaches 150°C (TYP.), the thermal shutdown circuit starts operating and the P-channel driver transistor will be turned off. At the same time, the output voltage decreases. When the temperature drops to 130°C (TYP.) after shutting off the current flow, the IC performs the soft start function to initiate output startup operation.

### < Function of CE pin >

The XCL211/XCL212 series will enter into stand-by mode by inputting a low level signal to the CE pin. During a stand-by mode, the current consumption of the IC becomes 0 μA (TYP.). The IC starts its operation by inputting a high level signal to the CE pin. The input of the CE pin is a CMOS input and the sink current is 0 μA (TYP.).

### <UVLO>

When the VIN pin voltage becomes 2.4V (TYP.) or lower, the P-channel MOS driver transistor output driver transistor is forced OFF to prevent false pulse output caused by unstable operation of the internal circuitry. When the VIN pin voltage becomes 2.68V (MAX.) or higher, switching operation takes place. By releasing the UVLO function, the IC performs the soft start function to initiate output startup operation. The soft start function operates even when the VIN pin voltage falls momentarily below the UVLO operating voltage. The UVLO circuit does not cause a complete shutdown of the IC, but causes pulse output to be suspended; therefore, the internal circuitry remains in operation.

### <Soft Start>

The XCL211/XCL212 series provide 1.0ms (TYP). Soft start time is defined as the time interval to reach 90% of the output voltage from the time when the VCE is turned on.

### <CL High Speed Discharge>

The XCL211/XCL212 series can quickly discharge the electric charge at the output capacitor (CL) when a low signal to the CE pin which enables a whole IC circuit put into OFF state, is inputted via the N-channel MOS switch transistor located between the LX pin and the V\_GND pin. When the IC is disabled, electric charge at the output capacitor (CL) is quickly discharged so that it may avoid application malfunction. Discharge time of the output capacitor (CL) is set by the CL auto-discharge resistance (R) and the output capacitor (CL). By setting time constant of a CL auto-discharge resistance value [R] and an output capacitor value (CL) as  $\tau$  ( $\tau = C \times R$ ), discharge time of the output voltage after discharge via the N-channel transistor is calculated by the following formulas.

$$V = V_{OUT(E)} \times e^{-t/\tau} \text{ or } t = \tau \ln(V_{OUT(E)}/V)$$

V : Output voltage after discharge

V<sub>OUT(E)</sub> : Output voltage

t: Discharge time

$\tau = C_L \times R_{DCHG}$

C<sub>L</sub> : Capacitance of Output capacitor

R<sub>DCHG</sub> : C<sub>L</sub> auto-discharge resistance

### Output Voltage Discharge characteristics

R<sub>DCHG</sub> = 130Ω(TYP.) C<sub>L</sub> = 20 μF

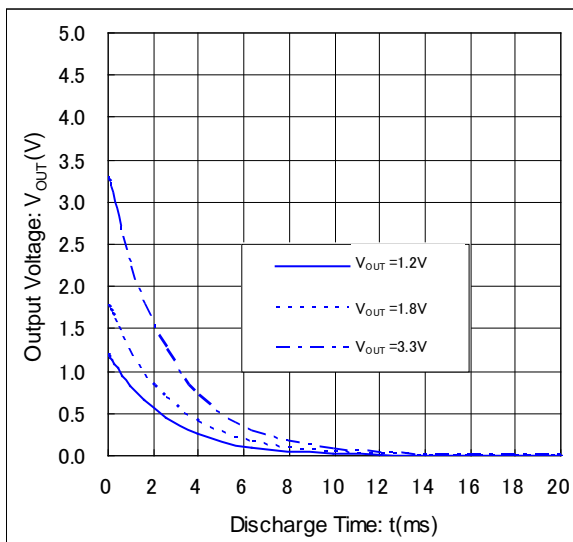



## ■ OPERATIONAL DESCRIPTION (Continued)

### <PFM Switch Current> <sup>(\*)</sup>

In PFM control operation, until coil current reaches to a specified level ( $I_{PFM}$ ), the IC keeps the P-channel MOS driver transistor on. In this case, time that the P-channel MOS driver transistor is kept on ( $t_{ON}$ ) can be given by the following formula. Please refer to  $I_{PFM}$ ①

$$t_{ON} = L \times I_{PFM} / (V_{IN} - V_{OUT})$$

### <PFM Duty Limit> <sup>(\*)</sup>

In PFM control operation, the PFM duty limit ( $DTY_{LIMIT\_PFM}$ ) is set to 200% (TYP.). Therefore, under the condition that the duty increases (e.g. the condition that the step-down ratio is small), it's possible for P-channel MOS driver transistor to be turned off even when coil current doesn't reach to  $I_{PFM}$ . Please refer to  $I_{PFM}$ ②

<sup>(\*)</sup> XCL211 Series is excluded.

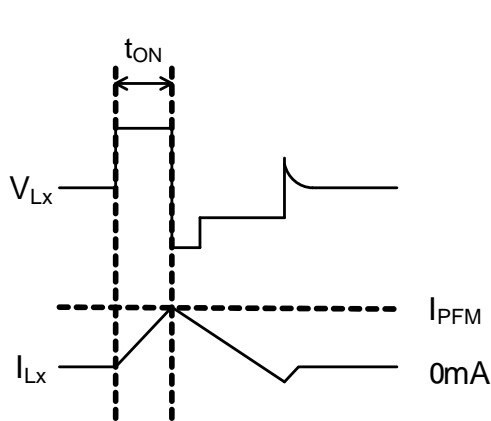

Fig.  $I_{PFM}$ ①

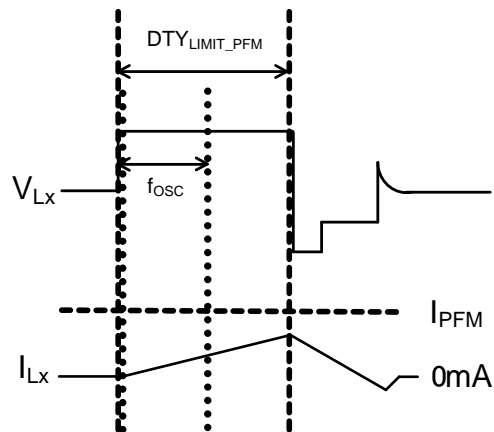

Fig.  $I_{PFM}$ ②

## NOTE ON USE

1. Please use this IC within the stated maximum ratings. For temporary, transitional voltage drop or voltage rising phenomenon, the IC is liable to malfunction should the ratings be exceeded.
2. Where wiring impedance is high, operations may become unstable due to noise and/or phase lag depending on output current. Please wire the input capacitor ( $C_{IN}$ ) and the output capacitor ( $C_L$ ) as close to the IC as possible.
3. When the difference between  $V_{IN}$  and  $V_{OUT}$  is large in PWM control, very narrow pulses will be outputted, and there is the possibility that some cycles may be skipped completely.
4. When the difference between  $V_{IN}$  and  $V_{OUT}$  is small, and the load current is heavy, very wide pulses will be outputted and there is the possibility that some cycles may be skipped completely.
5. With the IC, the peak current of the coil is controlled by the current limit circuit. Since the peak current increases when dropout voltage or load current is high, current limit starts operation, and this can lead to instability. When peak current becomes high, please adjust the coil inductance value and fully check the circuit operation. In addition, please calculate the peak current according to the following formula:

$$I_{pk} = (V_{IN} - V_{OUT}) \times \text{OnDuty} / (2 \times L \times f_{OSC}) + I_{OUT}$$

L : Coil Inductance Value  
 $f_{OSC}$ : Oscillation Frequency

6. Use of the IC at voltages below the recommended voltage range may lead to instability.
7. This IC should be used within the stated absolute maximum ratings in order to prevent damage to the device.
8. When the IC is used in high temperature, output voltage may increase up to input voltage level at no load because of the leak current of the P-channel driver transistor.
9. The XCL211/XCL212 uses fold-back circuit limiter. However, fold-back may become "droop" affected by the wiring conditions. Care must be taken especially for  $C_{IN}$  distance and position.
10. If  $C_L$  capacitance reduction happens such as in the case of low temperature, the IC may enter unstable operation. Care must be taken for  $C_L$  capacitor selection and its capacitance value.

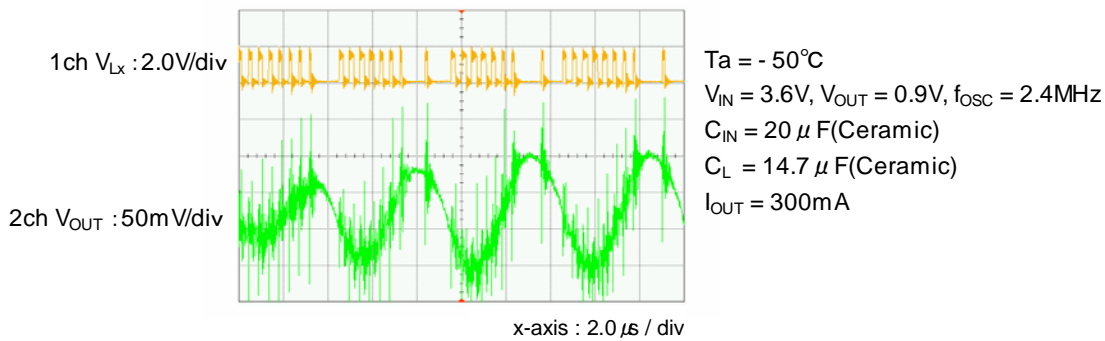

11. Torex places an importance on improving our products and its reliability. However, by any possibility, we would request user fail-safe design and post-aging treatment on system or equipment.

## NOTE ON USE (Continued)

### 12) Instructions of pattern layouts

- (1) In order to stabilize  $V_{IN}$  voltage level, we recommend that that a by-pass capacitor ( $C_{IN}$ ) be connected as close as possible to  $PV_{IN}$  pin,  $AV_{IN}$  pin and GND pins.
- (2) Make sure to avoid noise from the  $PV_{IN}$  pin to the  $AV_{IN}$  pin.
- (3) Please mount each external component as close to the IC as possible.
- (4) Wire external components as close to the IC as possible and use thick, short connecting traces to reduce the circuit impedance.
- (5) Make sure that the PCB GND traces are as thick as possible, as variations in ground potential caused by high ground currents at the time of switching may result in instability of the IC.
- (6) This series' internal driver transistors bring on heat because of the output current and ON resistance of P-channel and N-channel MOS driver transistors.

### <Reference Pattern Layout>

<1st>

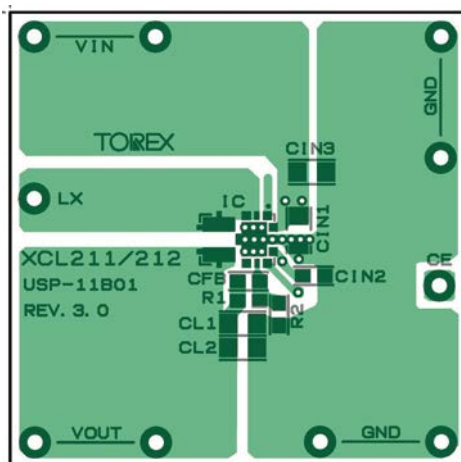

<2nd>

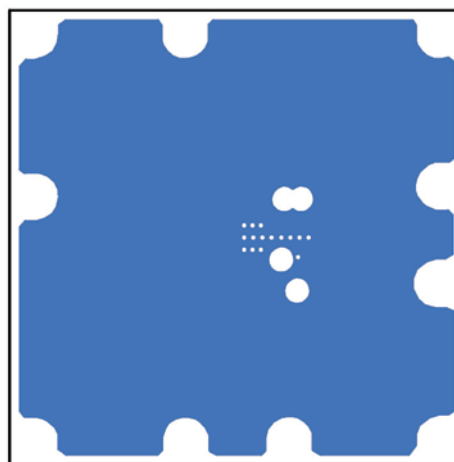

<3rd>



<4th>

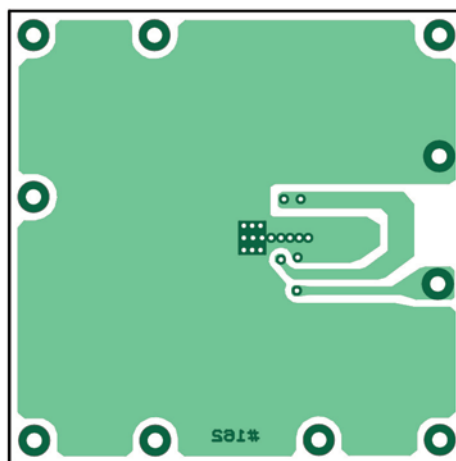

## TYPICAL PERFORMANCE CHARACTERISTICS

(1) Output Voltage vs. Output Current

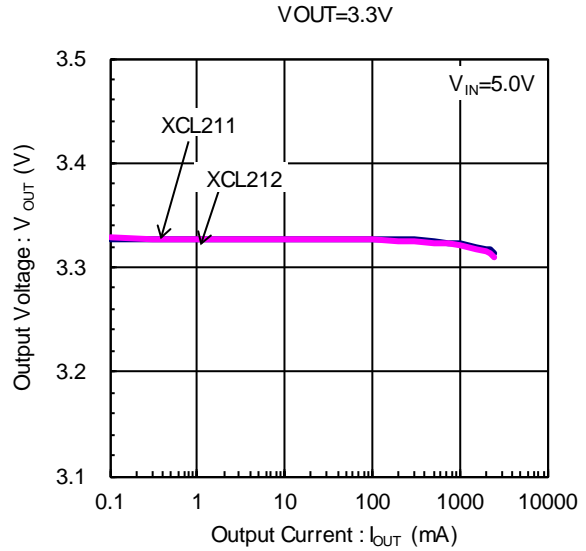
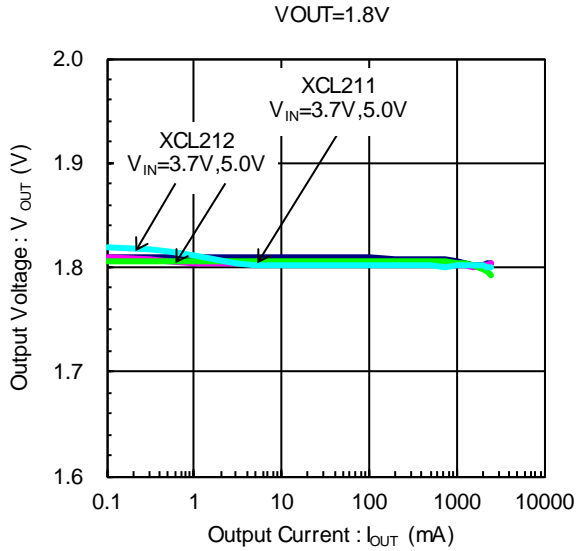

(2) Efficiency vs. Output Current

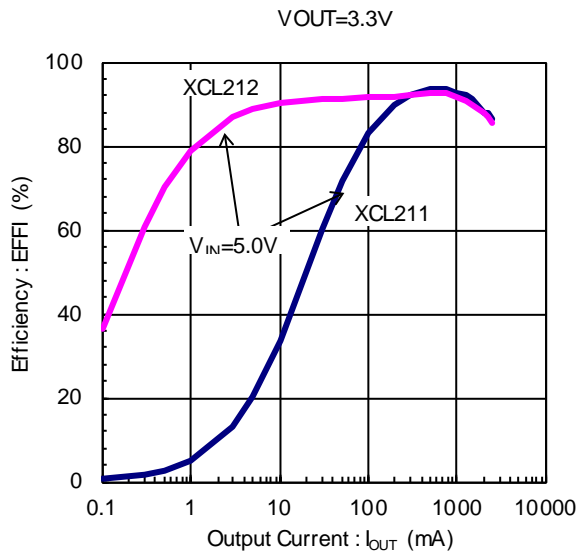
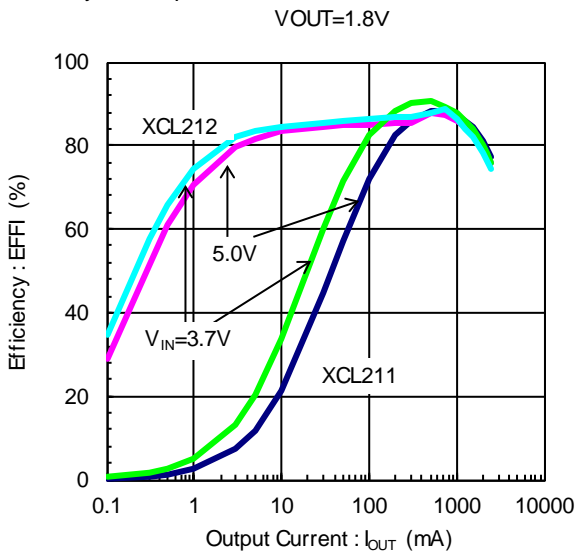

(3) Ripple Voltage vs. Output Current

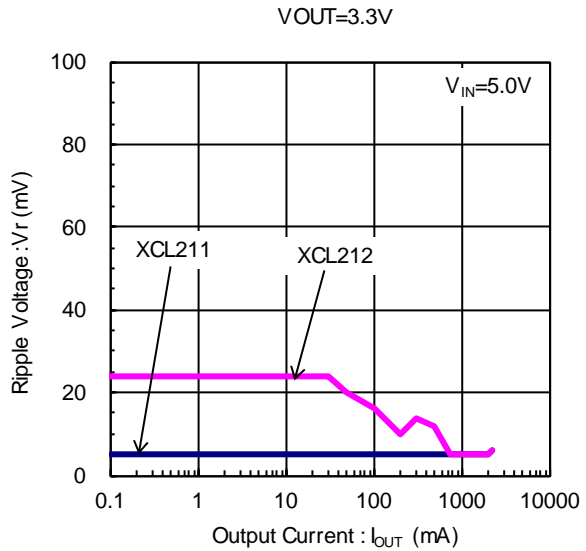
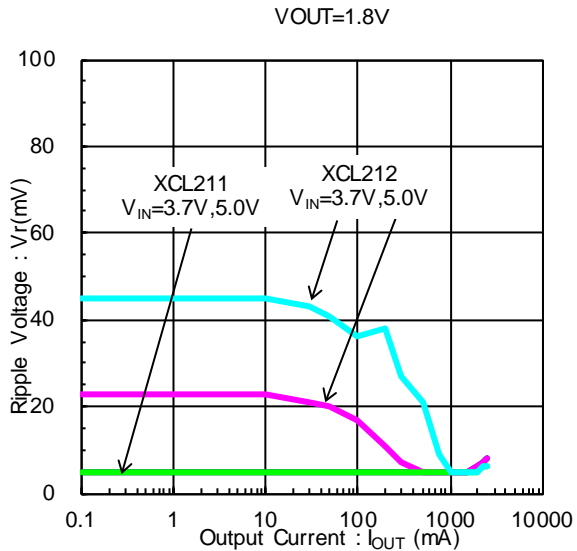

## TYPICAL PERFORMANCE CHARACTERISTICS (Continued)

(4) Output Voltage vs. Ambient Temperature  
 $V_{OUT}=1.8V$

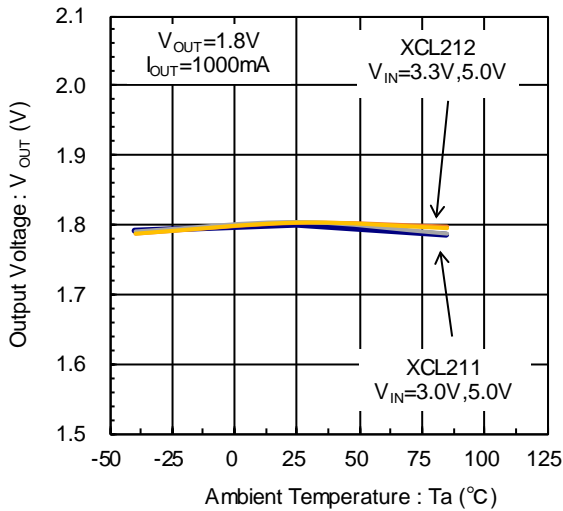

$V_{OUT}=3.3V$

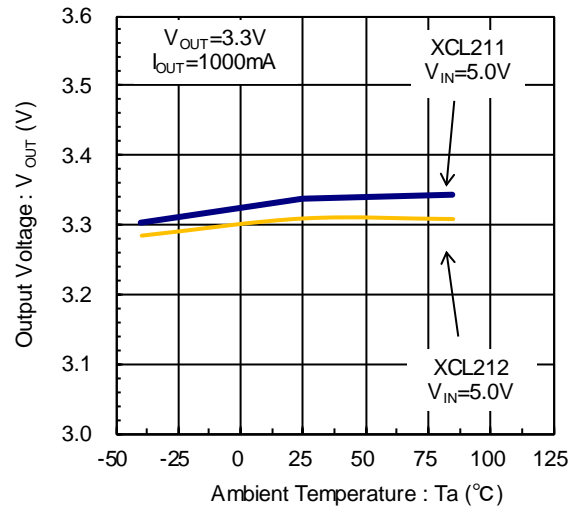

(5) Oscillation Frequency vs. Ambient Temperature  
XCL211B082DR  $V_{OUT}=1.8V$

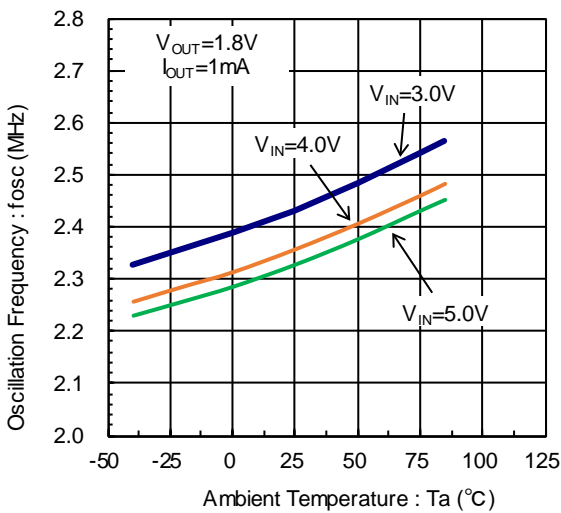

XCL211B082DR  $V_{OUT}=3.3V$

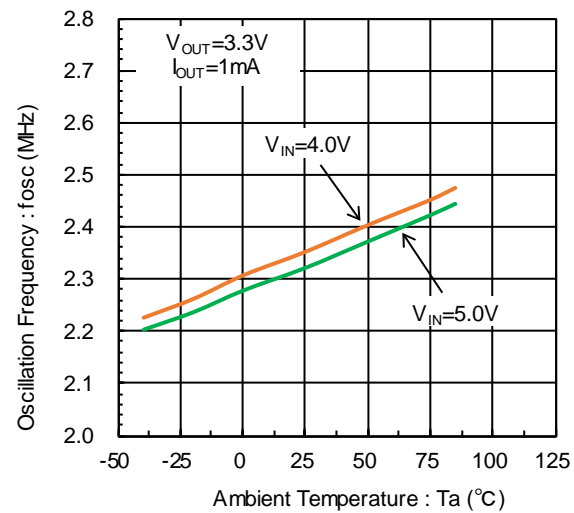

(6) Load Transient Response

XCL211B082DR  $V_{out}=1.8V$



XCL212B082DR  $V_{out}=1.8V$

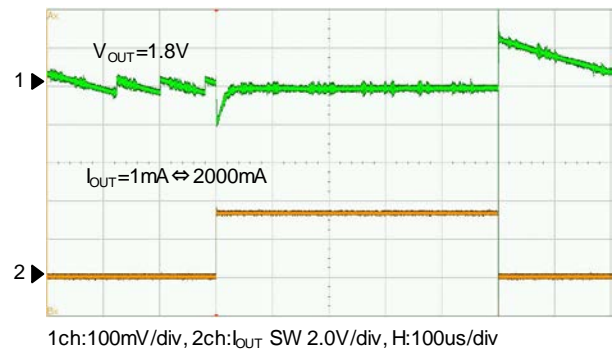



**● USP-11B01 Power Dissipation (40mm x 40mm Standard board)**

Power dissipation data for the USP-11B01 is shown in this page.  
The value of power dissipation varies with the mount board conditions.  
Please use this data as the reference data taken in the following condition.

1. Measurement Condition

- Condition : Mount on a board
- Ambient : Natural convection
- Soldering : Lead (Pb) free
- Board : Dimensions 40 x 40 mm  
(1600 mm<sup>2</sup> in one side)
- Copper (Cu) traces occupy 50% of the board area in top and back faces
- Package heat-sink is tied to the copper traces
- Material : Glass Epoxy (FR-4)
- Thickness : 1.6mm
- Through-hole : 4 x 0.8 Diameter

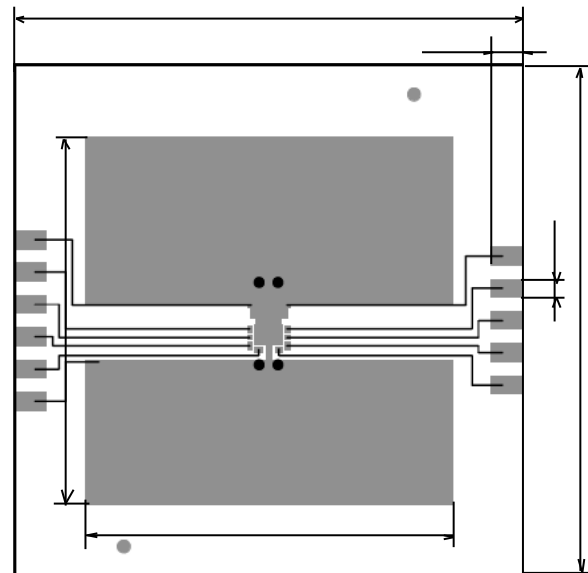

Evaluation Board (Unit : mm)

2. Power Dissipation vs. Ambient Temperature

Board Mount (T<sub>j</sub> max = 125°C)

| Ambient Temperature (°C) | Power Dissipation Pd (mW) | Thermal Resistance (°C/W) |
|--------------------------|---------------------------|---------------------------|
| 25                       | 1000                      | 100.00                    |
| 85                       | 400                       |                           |

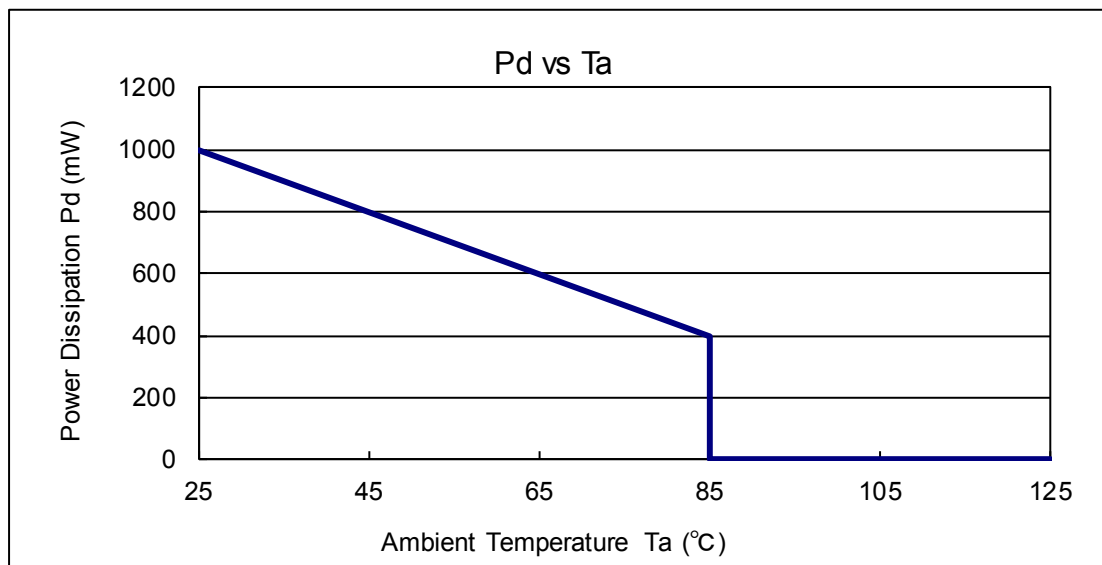

## MARKING RULE

● USP-11B01

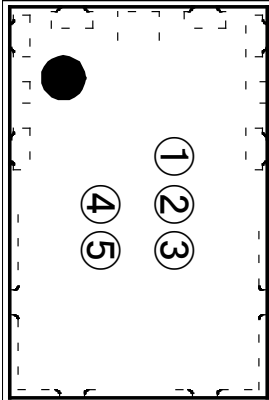

① represents product series

| MARK | PRODUCT SERIES |
|------|----------------|
| C    | XCL211*****    |
| D    | XCL212*****    |

② represents integer of the reference voltage

| MARK | REFERENCE VOLTAGE (V) | PRODUCT SERIES |
|------|-----------------------|----------------|
| A    | 0.8 (fix)             | XCL21**08***   |

③ represents oscillation frequency

| MARK | OSCILLATION FREQUENCY (MHz) | PRODUCT SERIES |
|------|-----------------------------|----------------|
| 2    | 2.4                         | XCL21****2**   |

④⑤ represents production lot number

01 to 09, 0A to 0Z, 11 to 9Z, A1 to A9, AA to AZ, B1 to ZZ repeated  
(G, I, J, O, Q, W excluded)

\*No character inversion used.



1. The product and product specifications contained herein are subject to change without notice to improve performance characteristics. Consult us, or our representatives before use, to confirm that the information in this datasheet is up to date.
2. The information in this datasheet is intended to illustrate the operation and characteristics of our products. We neither make warranties or representations with respect to the accuracy or completeness of the information contained in this datasheet nor grant any license to any intellectual property rights of ours or any third party concerning with the information in this datasheet.
3. Applicable export control laws and regulations should be complied and the procedures required by such laws and regulations should also be followed, when the product or any information contained in this datasheet is exported.
4. The product is neither intended nor warranted for use in equipment of systems which require extremely high levels of quality and/or reliability and/or a malfunction or failure which may cause loss of human life, bodily injury, serious property damage including but not limited to devices or equipment used in 1) nuclear facilities, 2) aerospace industry, 3) medical facilities, 4) automobile industry and other transportation industry and 5) safety devices and safety equipment to control combustions and explosions. Do not use the product for the above use unless agreed by us in writing in advance.
5. Although we make continuous efforts to improve the quality and reliability of our products; nevertheless Semiconductors are likely to fail with a certain probability. So in order to prevent personal injury and/or property damage resulting from such failure, customers are required to incorporate adequate safety measures in their designs, such as system fail safes, redundancy and fire prevention features.
6. Our products are not designed to be Radiation-resistant.
7. Please use the product listed in this datasheet within the specified ranges.
8. We assume no responsibility for damage or loss due to abnormal use.
9. All rights reserved. No part of this datasheet may be copied or reproduced unless agreed by Torex Semiconductor Ltd in writing in advance.

TOREX SEMICONDUCTOR LTD.

单击下面可查看定价，库存，交付和生命周期等信息

[>>Torex Semiconductor\(特瑞仕\)](#)