

200mA High Speed LDO Regulator with ON/OFF Switch

GENERAL DESCRIPTION

The XC6234 series is a 200mA high speed LDO regulator that features high accurate, high ripple rejection and low dropout. The series consists of a voltage reference, an error amplifier, a driver transistor, a current limiter, a phase compensation circuit and an inrush current protection circuit.

The output voltage is selectable from 1.2V, 1.5V, 1.8V, 2.5V, 2.8V, 3.0V and 3.3V.

The CE function enables the circuit to be in stand-by mode by inputting low level signal. In the stand-by mode, the series enables the electric charge at the output capacitor C_L to be discharged via the internal switch, and as a result the V_{OUT} pin quickly returns to the V_{SS} level.

The series is also compatible with low ESR ceramic capacitors, which provides stable output voltage. This stability can be maintained even during load fluctuations due to the excellent transient response.

The over current protection circuit is integrated and operates when the output current reaches current limit level.

APPLICATIONS

- Mobile
- Wireless LAN
- Module
- Cell phones
- Smartphones

FEATURES

Maximum Output Current	: 200mA
Input Voltage Range	: 1.7V~5.5V
Output Voltages	: 1.2V, 1.5V, 1.8V, 2.5V, 2.8V, 3.0V, 3.3V
Dropout Voltage	: 240mV @ $I_{OUT}=200mA$ ($V_{OUT}=3.0V$)
Low Power Consumption	: 45 μ A (TYP.)
Stand-by Current	: 0.1 μ A
High Ripple Rejection	: 75dB@1kHz
CE Pin Function	: Active High C_L Auto Discharge
Protection Circuit	: Current Limit 255mA (TYP.) Short Circuit Protection 60mA (TYP.)
External Capacitor	: Ceramic Capacitor Compatible 1.0 μ F
Operating Ambient Temperature	: -40°C~+85°C
Package	: SOT-25J
Environmentally Friendly	: EU RoHS Compliant, Pb Free

TYPICAL APPLICATION CIRCUIT

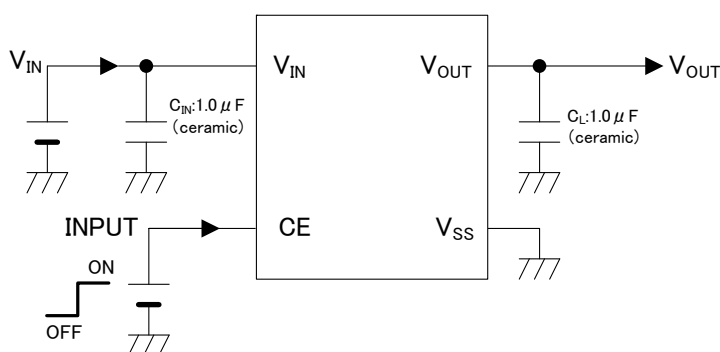

TYPICAL PERFORMANCE CHARACTERISTICS

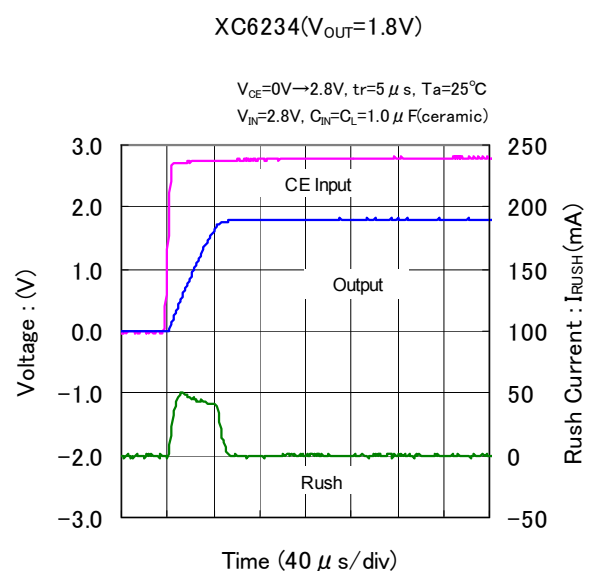

■ BLOCK DIAGRAM

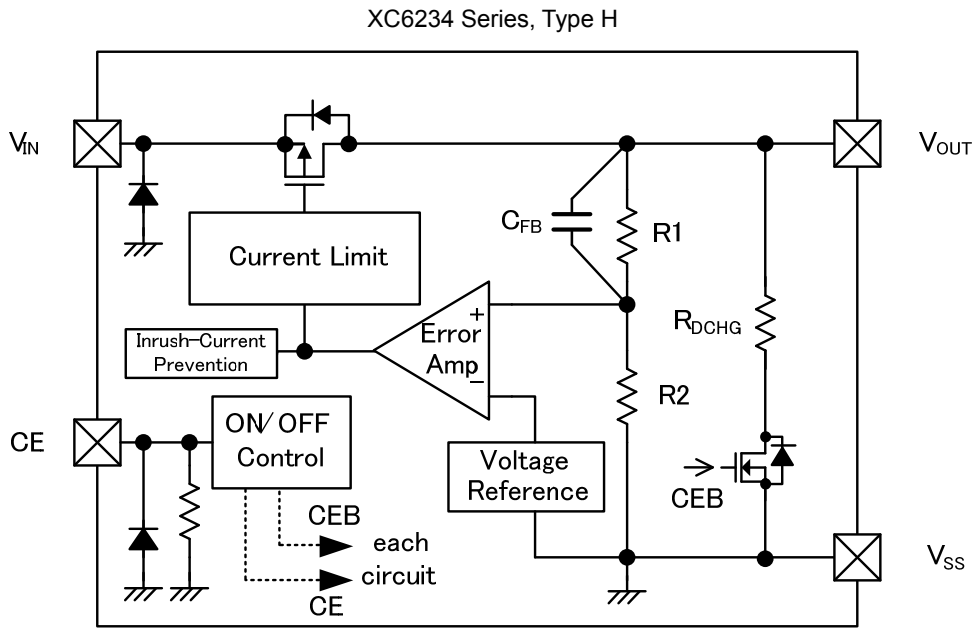

* Diodes inside the circuits are ESD protection diodes and parasitic diodes.

■ PRODUCT CLASSIFICATION

● Ordering Information

XC6234①②③④⑤⑥-⑦

DESIGNATOR	ITEM	SYMBOL	DESCRIPTION
①	Type (CE Active High)	H	Includes Inrush Current Prevention, CE Pull-down and C_L Auto-discharge
②③	Output Voltage	12~33	②③=12 : 1.2V ②③=15 : 1.5V ②③=18 : 1.8V ②③=25 : 2.5V ②③=28 : 2.8V ②③=30 : 3.0V ②③=33 : 3.3V
④	Output Voltage Accuracy	1	$\pm 1\%$ ($V_{OUT} \geq 2.00V$), $\pm 0.02V$ ($V_{OUT} < 2.00V$)
⑤⑥-⑦ (*1)	Package (Order Unit)	VR-G	SOT-25J (3,000/Reel)

(*1) The "-G" suffix denotes Halogen and Antimony free as well as being fully RoHS compliant.

■ PIN CONFIGURATION

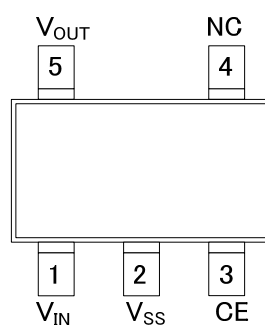

SOT-25J
(TOP VIEW)

PIN ASSIGNMENT

PIN NUMBER	PIN NAME	FUNCTIONS
SOT-25J		
1	V _{IN}	Power Supply Input
2	V _{SS}	Ground
3	CE	ON/OFF Control
4	NC	No Connection
5	V _{OUT}	Output

■ PIN FUNCTION ASSIGNMENT

PIN NAME	SIGNAL	STATUS
CE	L	Stand-by
	H	Active
	OPEN	Stand-by *

* For H type, CE pin voltage is fixed as L level because of internal pull-down resistor.

■ ABSOLUTE MAXIMUM RATINGS

Ta=25

PARAMETER	SYMBOL	RATINGS	UNITS
Input Voltage	V _{IN}	-0.3 ~ +6.0	V
Output Current	I _{OUT}	275 ⁽¹⁾	mA
Output Voltage	V _{OUT}	-0.3 ~ V _{IN} +0.3 or +6.0 ⁽²⁾	V
CE Input Voltage	V _{CE}	-0.3 ~ +6.0	V
Power Dissipation	SOT-25J Pd	500 (PCB mounted) ⁽³⁾	mW
Operating Ambient Temperature	T _{opr}	-40 ~ +85	
Storage Temperature	T _{stg}	-55 ~ +125	

* All voltages are described based on V_{SS}.

⁽¹⁾ I_{OUT} = Pd / (V_{IN} - V_{OUT})

⁽²⁾ The maximum value should be either V_{IN}+0.3 or +6.0 in the lowest.

⁽³⁾ This is a reference data taken by using the test board. Please refer to page 21 for details.

ELECTRICAL CHARACTERISTICS

XC6234 Series

Ta=25°C

PARAMETER	SYMBOL	CONDITIONS	MIN.	TYP.	MAX.	UNITS	CIRCUIT
Output Voltage	$V_{OUT(E)}$ ⁽¹⁾	$V_{OUT(T)} \geq 2.0V$	$V_{OUT(T)} \times 0.99$ ⁽²⁾	$V_{OUT(T)}$ ⁽²⁾	$V_{OUT(T)} \times 1.01$ ⁽²⁾	V	①
			E-0 ⁽³⁾				
		$V_{OUT(T)} < 2.0V$	$V_{OUT(T)} - 0.02$ ⁽²⁾	$V_{OUT(T)}$ ⁽²⁾	$V_{OUT(T)} + 0.02$ ⁽²⁾		
			E-0 ⁽³⁾				
Maximum Output Current	I_{OUTMAX}	-	200	-	-	mA	①
Load Regulation	ΔV_{OUT}	$0.1mA \leq I_{OUT} \leq 200mA$	-	25	45	mV	①
Dropout Voltage	V_{dif} ⁽⁴⁾	$I_{OUT} = 200mA$	-	E-1 ⁽⁵⁾		mV	①
Supply Current	I_{DD}	$I_{OUT} = 0mA$	-	45	87	μA	②
Stand-by Current	I_{STB}	$V_{CE} = V_{SS}$	-	0.01	0.10	μA	②
Line Regulation	$\frac{\Delta V_{OUT}}{(\Delta V_{IN} \cdot V_{OUT})}$	$V_{OUT(T)} < 2.0V, I_{OUT} = 30mA$ $2.5V \leq V_{IN} \leq 5.5V$	-	0.02	0.10	%V	①
		$V_{OUT(T)} \geq 2.0V, I_{OUT} = 30mA$ $V_{OUT(T)} + 0.5V \leq V_{IN} \leq 5.5V$					
Input Voltage	V_{IN}	-	1.7	-	5.5	V	①
Output Voltage Temperature Characteristics	$\frac{\Delta V_{OUT}}{(\Delta T_{opr} \cdot V_{OUT})}$	$I_{OUT} = 10mA$ $-40^\circ C \leq T_{opr} \leq 85^\circ C$	-	± 80	-	ppm/°C	①
Power Supply Rejection Ratio	PSRR	$V_{OUT(T)} < 2.5V$ $V_{IN} = 3.0V_{DC} + 0.5V_{p-pAC}$ $V_{CE} = V_{OUT(T)} + 1.0V$ $I_{OUT} = 30mA, f = 1kHz$	-	75	-	dB	③
		$V_{OUT(T)} \geq 2.5V$ $V_{IN} = \{V_{OUT(T)} + 1.0\} + 0.5V_{p-pAC}$ $V_{CE} = V_{OUT(T)} + 1.0V$ $I_{OUT} = 30mA, f = 1kHz$					
Current Limit	I_{LIM}	-	200	255	-	mA	①
Short Current	I_{SHORT}	$V_{OUT} = V_{SS}$	-	60	-	mA	①
CE "H" Level Voltage	V_{CEH}	-	0.9	-	5.5	V	①
CE "L" Level Voltage	V_{CEL}	-	V_{SS}	-	0.3	V	①
CE "H" Level Current (Type H)	I_{CEH}	$V_{CE} = V_{IN} = 5.5V$	2.5	6.0	9.5	μA	①
CE "L" Level Current	I_{CEL}	$V_{CE} = V_{SS}$	-0.1	-	0.1	μA	①
C_L Auto-discharge Resistance	R_{DCHG}	$V_{IN} = 5.5V, V_{CE} = V_{SS}$ $V_{OUT} = 2.0V$	-	270	-	Ω	①
Inrush Current	I_{RUSH}	$V_{IN} = 5.5V, V_{CE} = 0 \rightarrow 5.5V$	-	95	-	mA	④

NOTE:

Unless otherwise stated $V_{IN} = V_{OUT(T)} + 1V, V_{CE} = V_{IN}, I_{OUT} = 1mA$

⁽¹⁾ $V_{OUT(E)}$ is Effective output voltage

⁽²⁾ $V_{OUT(T)}$ is Nominal output voltage

⁽³⁾ E-0: OUTPUT VOLTAGE (Refer to the Voltage Chart)

⁽⁴⁾ $V_{dif} = \{V_{IN1} - V_{OUT1}\}$

V_{IN1} is the input voltage when V_{OUT1} appears at the V_{OUT} pin while input voltage is gradually decreased.

V_{OUT1} is the voltage equal to 98% of the normal output voltage when amply stabilized $V_{OUT(T)} + 1.0V$ is input at the V_{IN} pin.

⁽⁵⁾ E-1: DROPOUT VOLTAGE (Refer to the dropout Voltage Chart)

■ ELECTRICAL CHARACTERISTICS(Continued)

Voltage Chart

NOMINAL OUTPUT VOLTAGE (V)	E-0		E-1	
	OUTPUT VOLTAGE (V)		DROPOUT VOLTAGE (mV)	
V _{OUT(T)}	V _{OUT(E)}		V _{dif}	
	MIN.	MAX.	TYP.	MAX.
1.20	1.1800	1.2200	680	950
1.50	1.4800	1.5200	600	695
1.80	1.7800	1.8200	400	600
2.50	2.4750	2.5250	310	420
2.80	2.7720	2.8280		
3.00	2.9700	3.0300	240	380
3.30	3.2670	3.3330		

TEST CIRCUITS

$C_{IN}=1.0\ \mu F$, $C_L=1.0\ \mu F$

Circuit ①

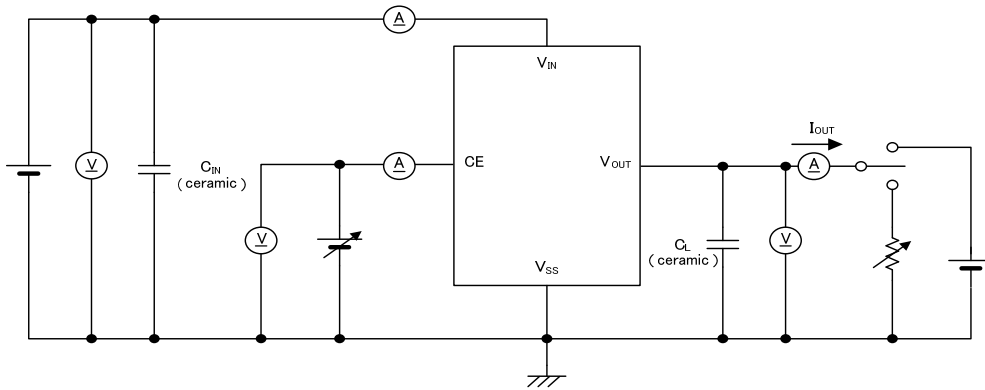

Circuit ②

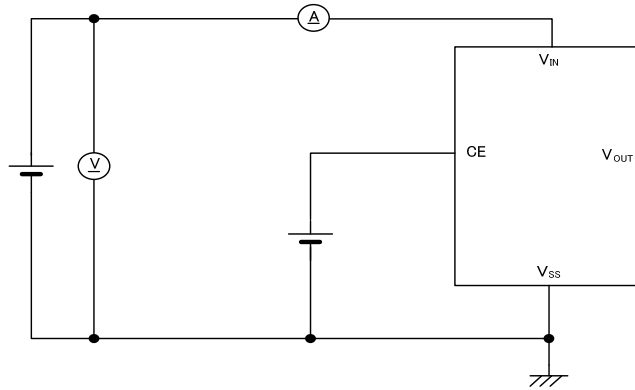

Circuit ③

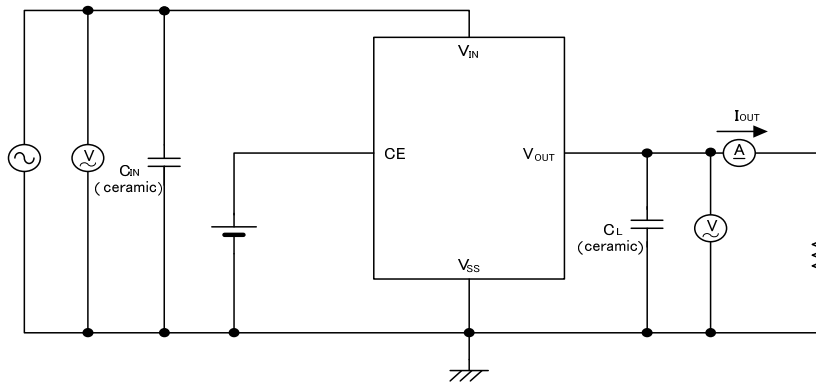

Circuit ④

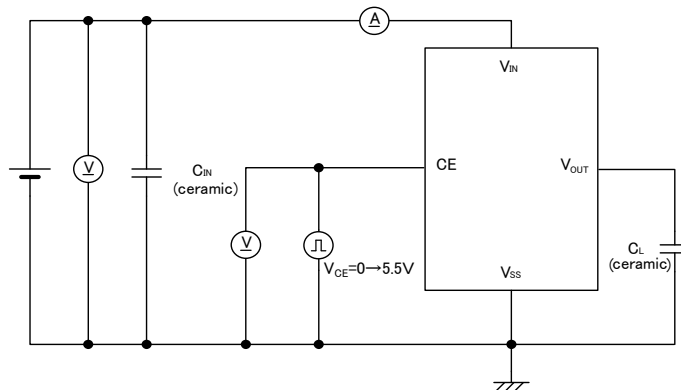

■ OPERATIONAL EXPLANATION

The voltage divided by resistors R1 & R2 is compared with the internal reference voltage by the error amplifier. The P-channel MOSFET which is connected to the V_{OUT} pin is then driven by the subsequent control signal. The output voltage at the V_{OUT} pin is controlled and stabilized by a system of negative feedback. The current limit circuit and short circuit protection operate in relation to the level of output voltage and output current.

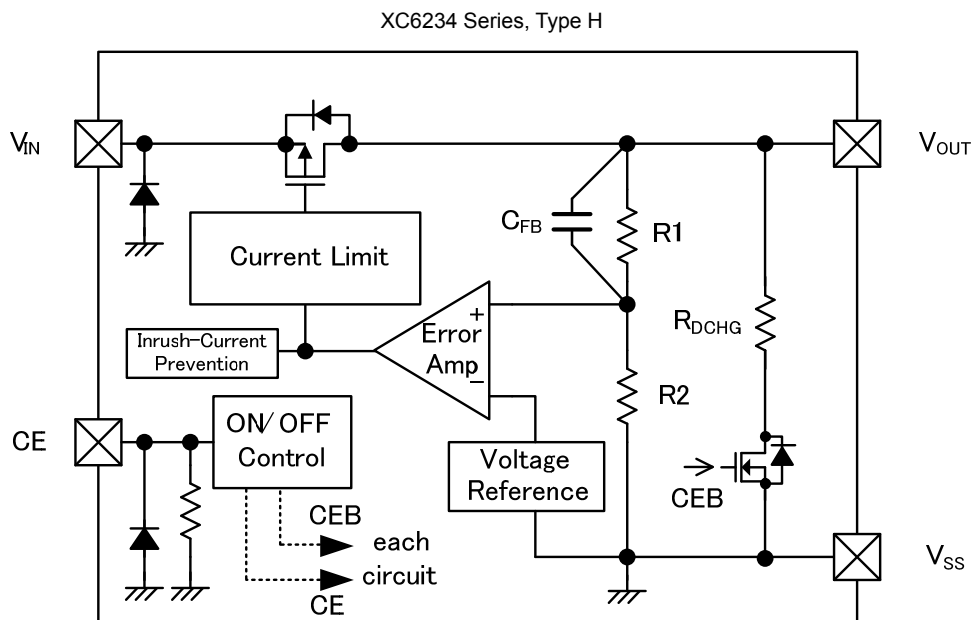

< Low ESR Capacitor >

The XC6234 series needs an output capacitor (C_L) for phase compensation. In order to ensure the stable phase compensation, please place an output capacitor of $1.0 \mu\text{F}$ at the V_{OUT} pin and V_{SS} pin as close as possible. For a stable power input, please connect an input capacitor (C_{IN}) of $1.0 \mu\text{F}$ between the input pin (V_{IN}) and the ground pin (V_{SS}).

<Current Limiter, Short-Circuit Protection >

The XC6234 series has current limiter and droop shape of fold-back circuit. When the load current reaches the current limit, the droop current limiter circuit operates and the output voltage drops with keeping the load current. After that, the output voltage drops to a certain level, the fold-back circuit operates and the output current goes to decrease with a degree of output voltage decreasing. The output current finally reaches at the level of 60mA (TYP.) when the output pin is short-circuited.

<CE Pin>

The IC's internal circuitry can be shutdown via the signal of the CE pin. The XC6234 series has a pull-down resistor at the CE pin inside. Even the CE pin is left open, the CE pin is fixed as Low level. However, inflow current is generated into the CE pin.

■ OPERATIONAL EXPLANATION (Continued)

<C_L High-speed Discharge Function>

The N-ch transistor located between the V_{OUT} pin and the V_{SS} pin and the C_L discharge resistance is set to 270Ω (TYP.) when V_{IN} is 5.5V (TYP.) and V_{OUT} is 2.0V (TYP.).

This N-ch transistor can quickly discharge the electric charge at the output capacitor (C_L), when a low signal is inputted to the CE pin. Moreover, discharge time of the output capacitor (C_L) is set by the C_L auto-discharge resistance (R_{DCHG}) and the output capacitance (C_L).

By setting time constant of a C_L auto-discharge resistance (R_{DCHG}) and an output capacitance (C_L) as τ ($\tau = C_L \times R_{DCHG}$), the output voltage after discharge via the N-ch transistor is calculated by the following formula.

$$V = V_{OUT(E)} \times e^{-t/\tau}$$

V: Output voltage after discharge

V_{OUT(E)}: Output voltage

t: Discharge time

τ : R_{DCHG} × C_L

C_L: Output capacitance

R_{DCHG}: C_L auto-discharge resistance

or discharge time is calculated by the next formula.

$$t = \tau \ln (V_{OUT(E)} / V)$$

< Inrush Current Prevention >

The inrush current prevention circuit is built in the XC6234 series.

When the IC starts to operate, the prevention circuit limits the inrush current as 95mA (TYP.) from input pin (V_{IN}) to output pin (V_{OUT}) for charging C_L capacitor. However, the device can not provide the output current beyond 95mA (TYP.) for a period of approximately 100 μs because internal control of the IC.

■ NOTES ON USE

1. For temporary, transitional voltage drop or voltage rising phenomenon, the IC is liable to malfunction should the ratings be exceeded.
2. Where wiring impedance is high, operations may become unstable due to noise and/or phase lag depending on output current. Please strengthen V_{IN} and V_{SS} wiring in particular.
3. Please wire the input capacitor (C_{IN}) and the output capacitor (C_L) as close to the IC as possible.
4. Torex places an importance on improving our products and their reliability.
We request that users incorporate fail-safe designs and post-aging prevention treatment when using Torex products in their systems.

TYPICAL PERFORMANCE CHARACTERISTICS

(1) Output Voltage vs. Output Current

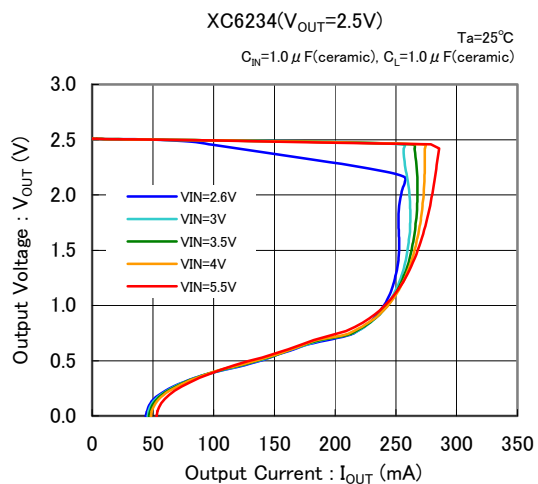
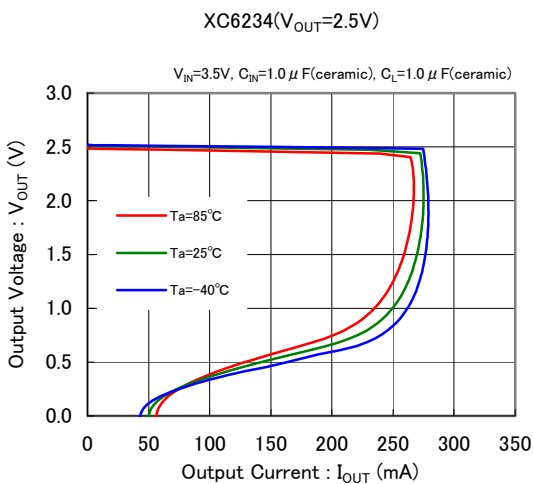
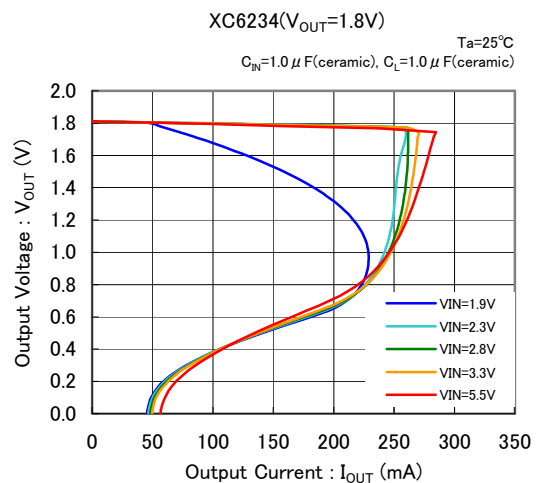
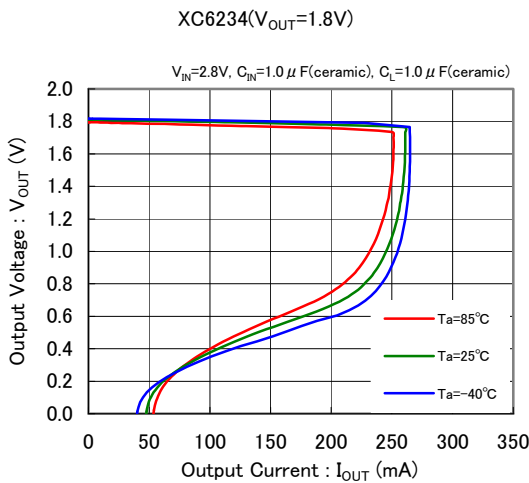
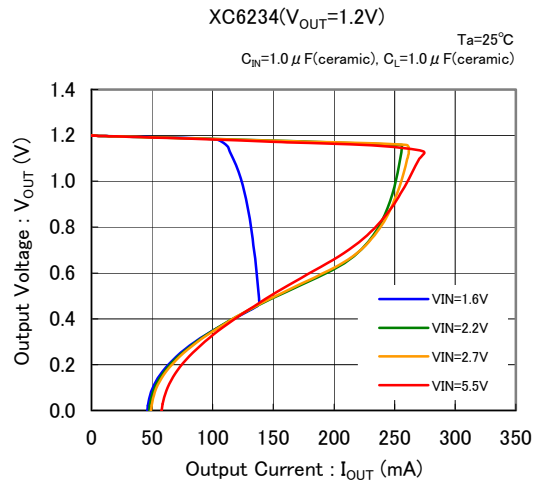
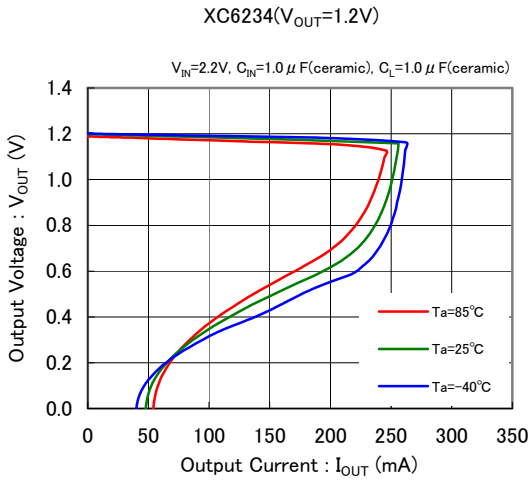

■ TYPICAL PERFORMANCE CHARACTERISTICS (Continued)

(1) Output Voltage vs. Output Current (Continued)

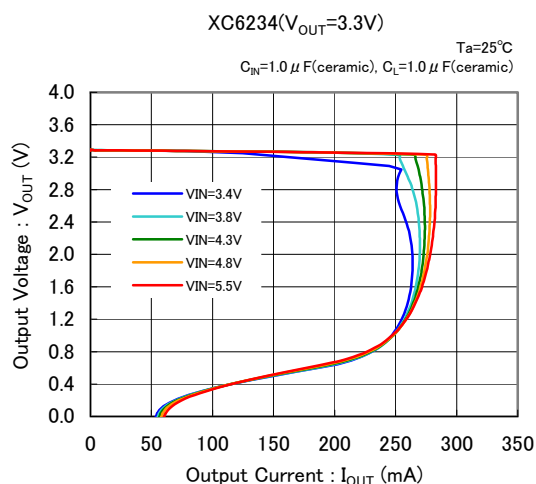
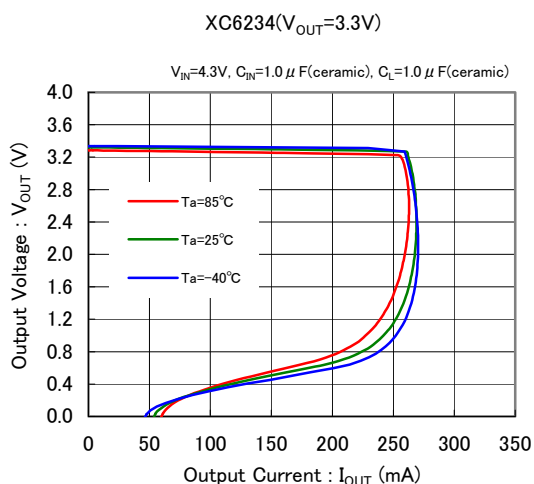

(2) Output Voltage vs. Input Voltage

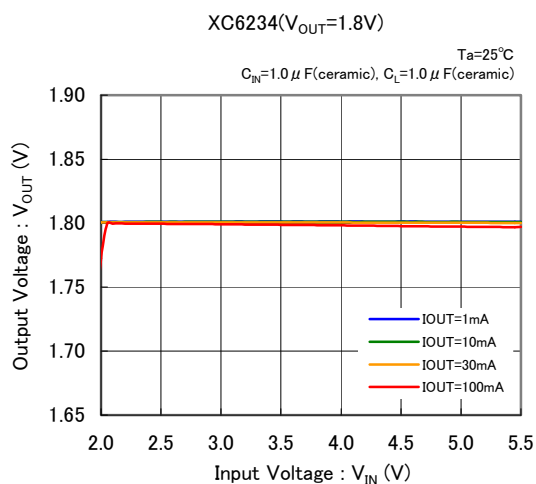
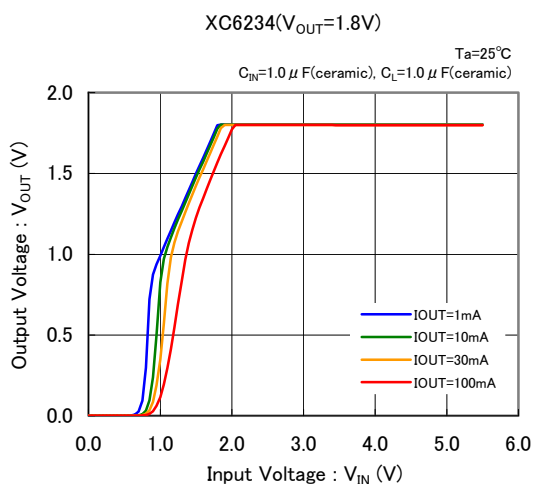
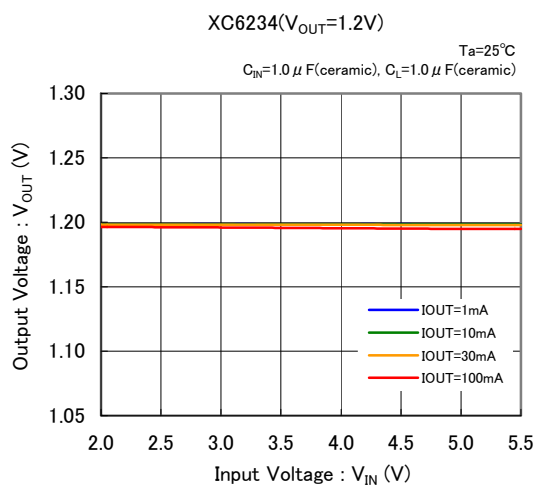
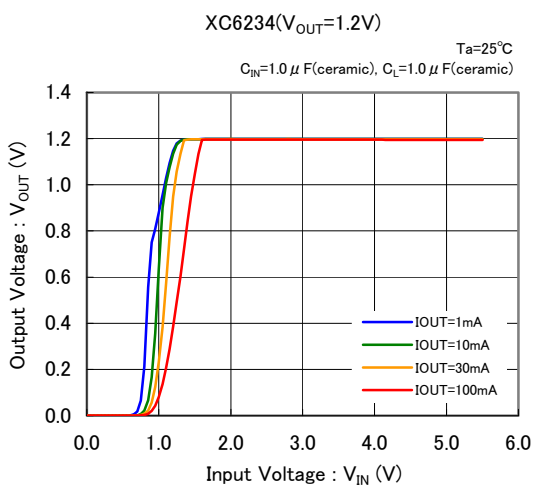

TYPICAL PERFORMANCE CHARACTERISTICS (Continued)

(2) Output Voltage vs. Input Voltage (Continued)

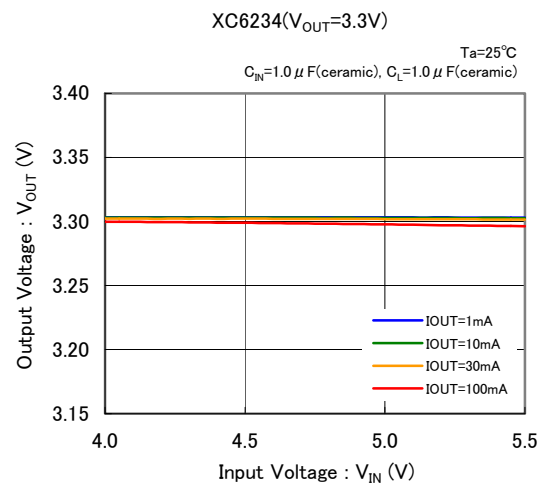
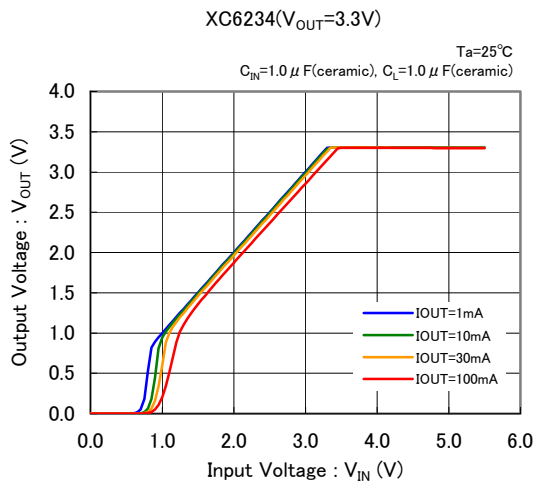
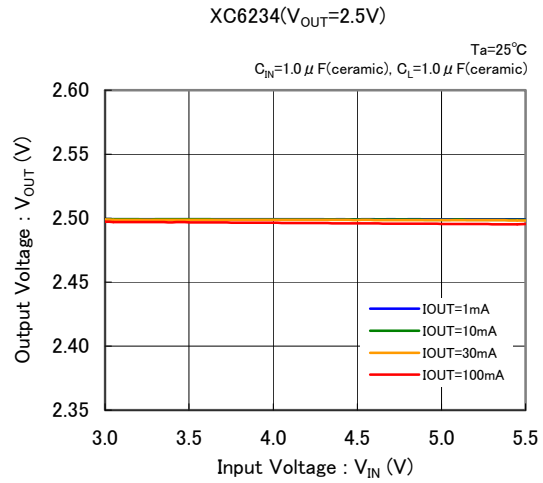
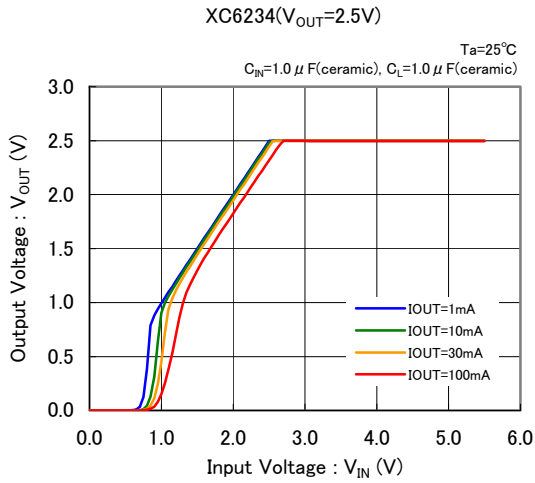

(3) Dropout Voltage vs. Output Current

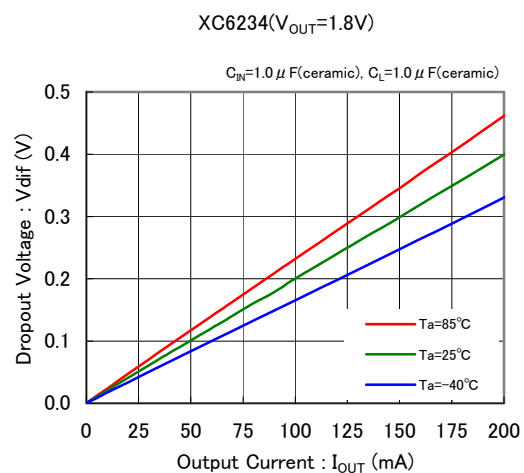
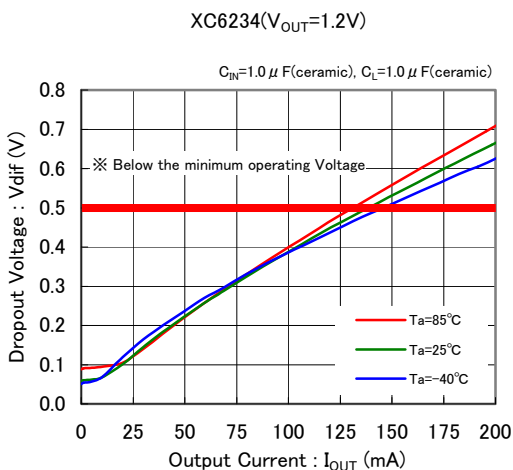

■ TYPICAL PERFORMANCE CHARACTERISTICS (Continued)

(3) Dropout Voltage vs. Output Current (Continued)

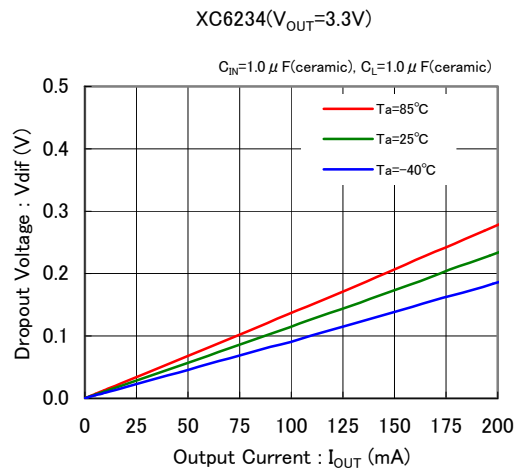
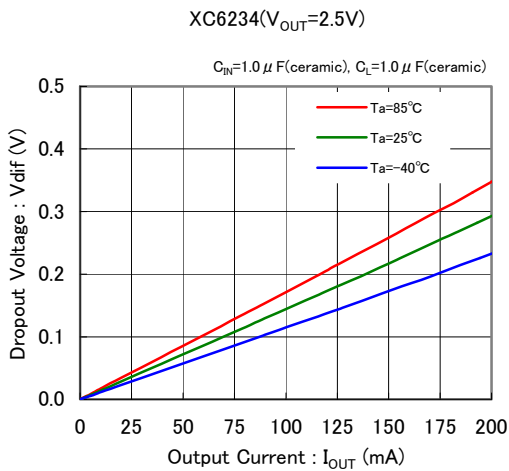

(4) Supply Current vs. Input Voltage

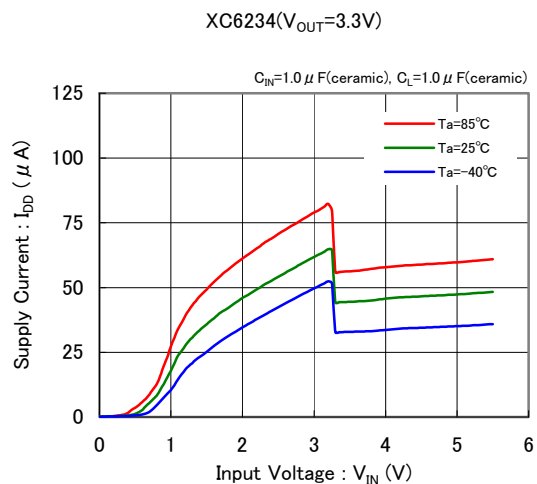
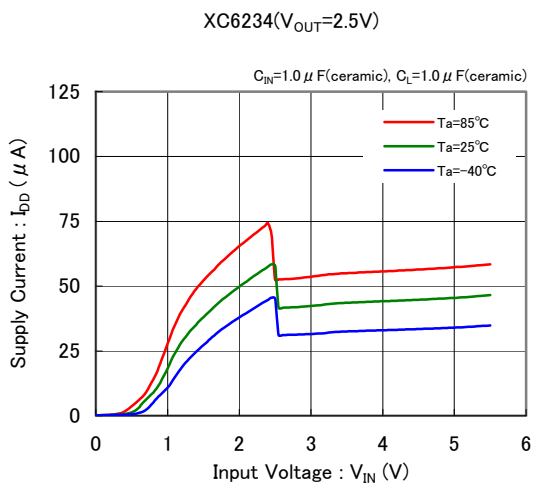
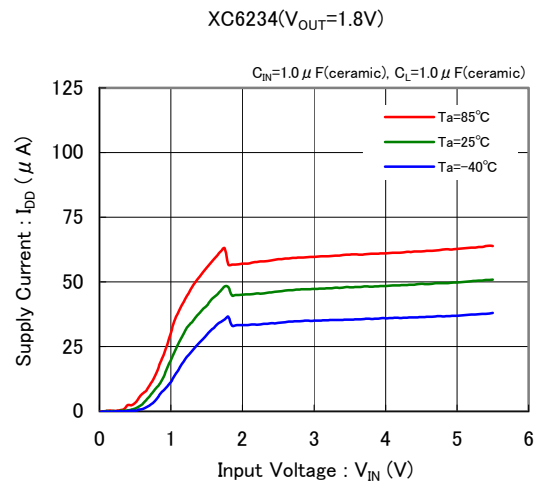
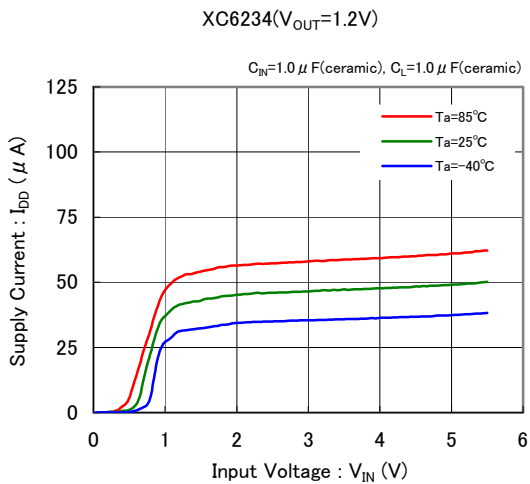

TYPICAL PERFORMANCE CHARACTERISTICS (Continued)

(5) Output Voltage vs. Ambient Temperature

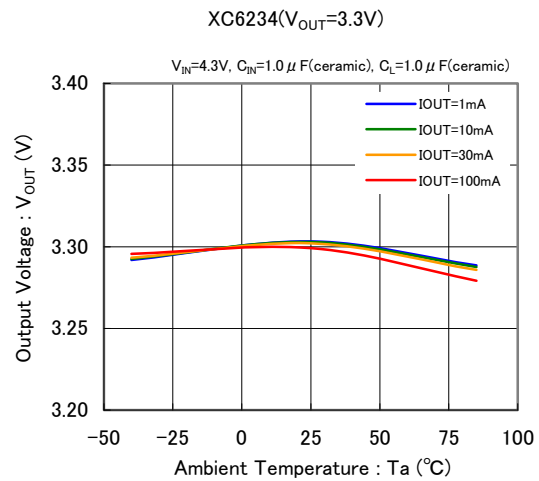
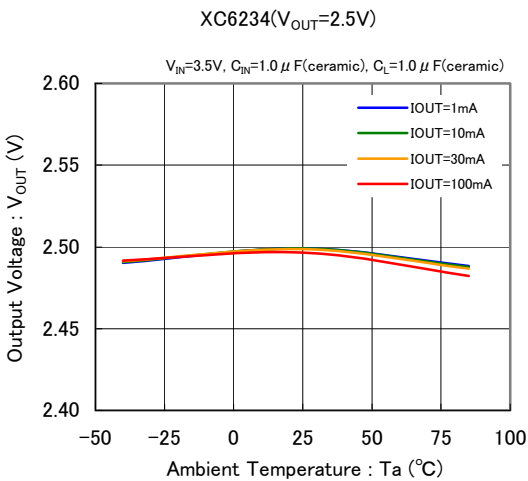
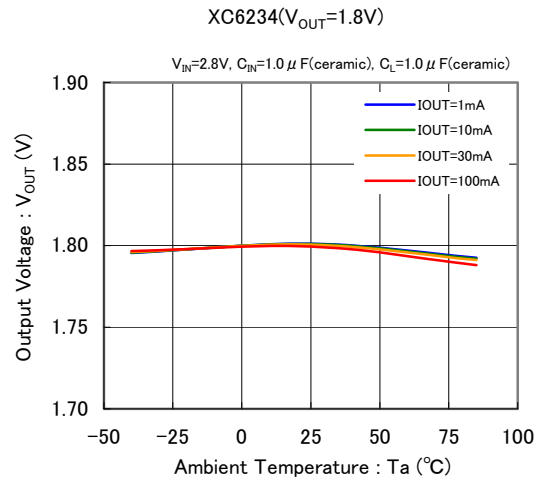
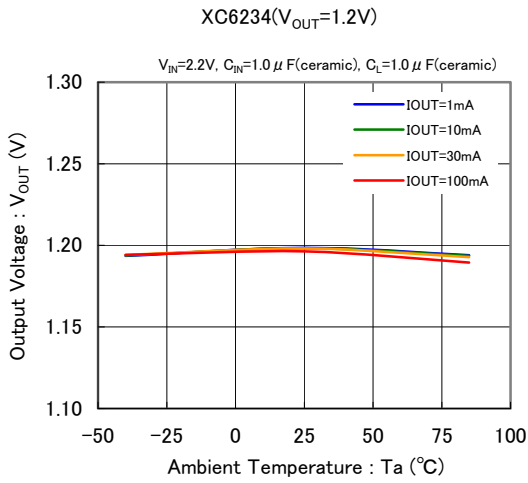

(6) Supply Current vs. Ambient Temperature

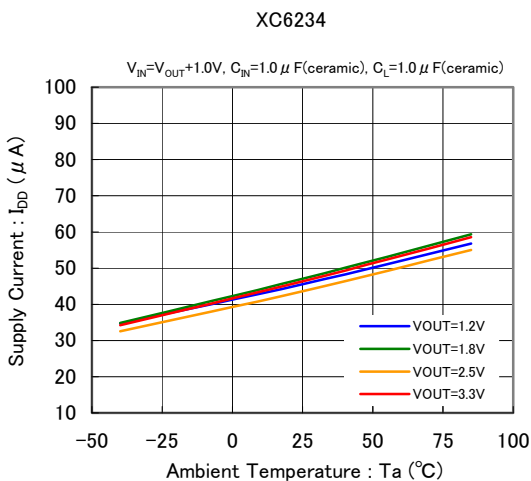

(7) CE Threshold Voltage vs. Ambient Temperature

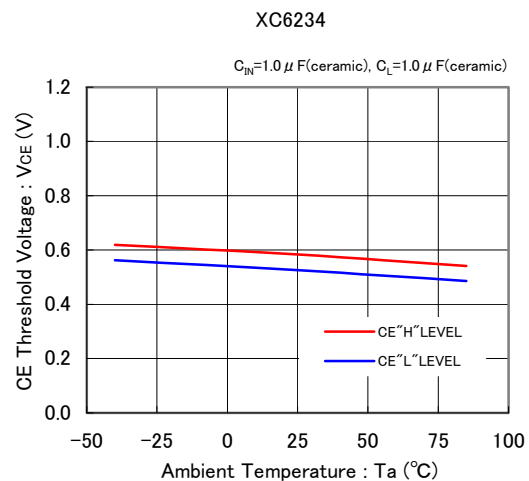

TYPICAL PERFORMANCE CHARACTERISTICS (Continued)

(8) Rising Response Time

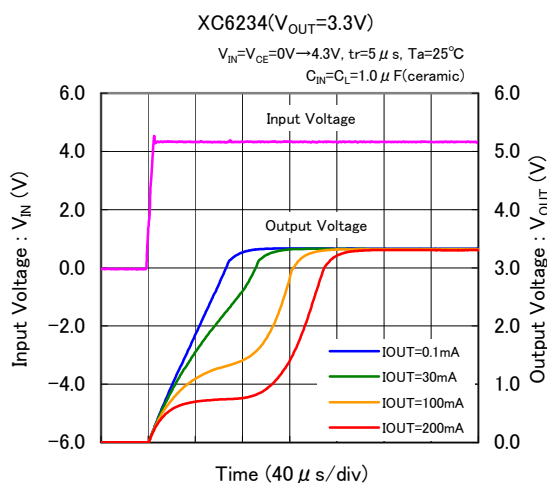
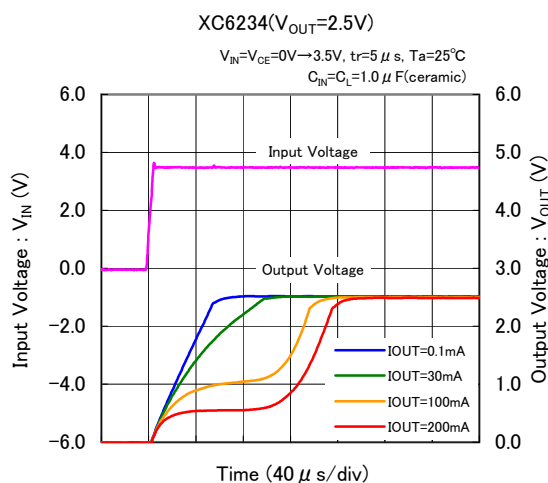
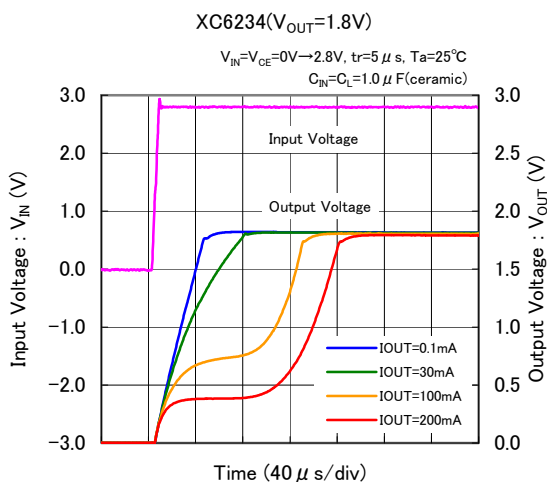
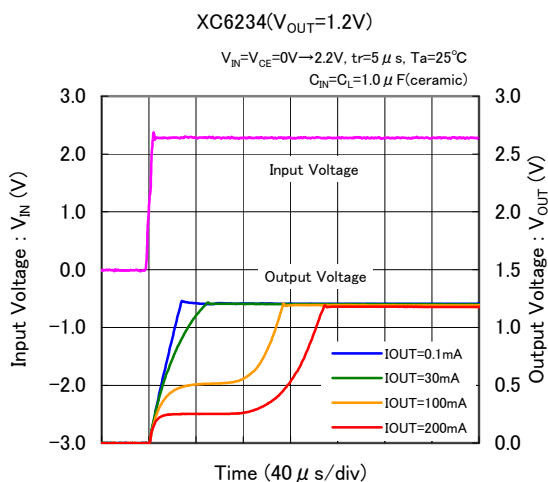

(9) Input Transient Response

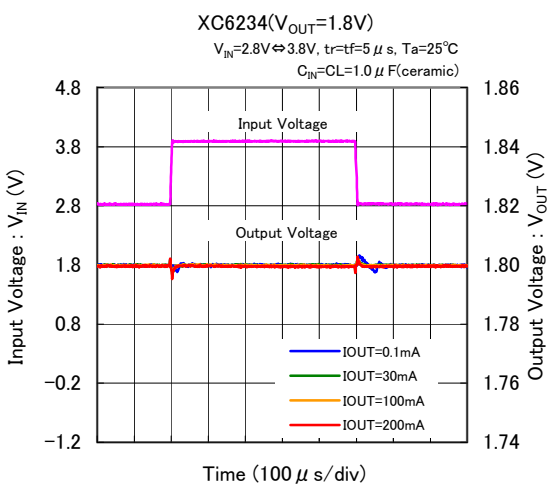
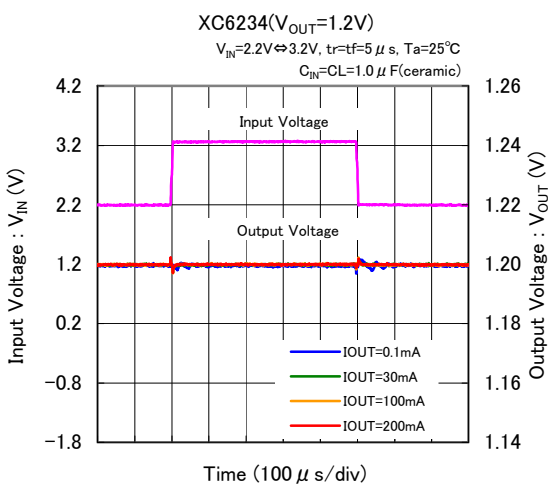

TYPICAL PERFORMANCE CHARACTERISTICS (Continued)

(9) Input Transient Response (Continued)

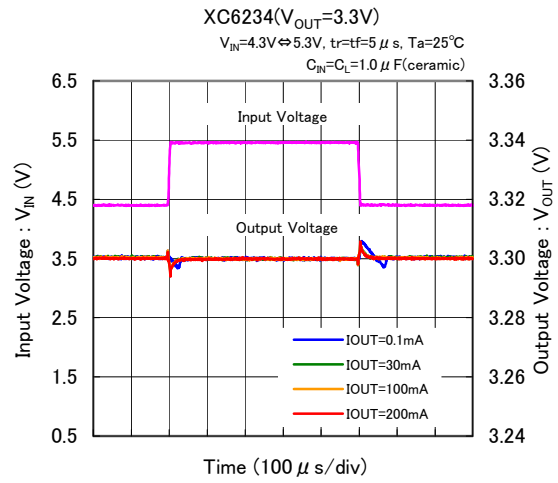
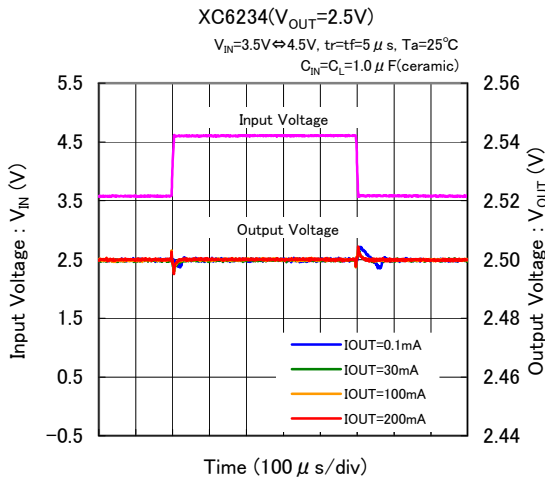

(10) Load Transient Response

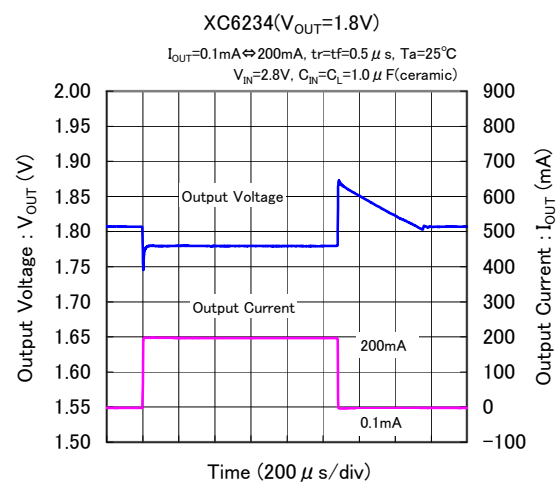
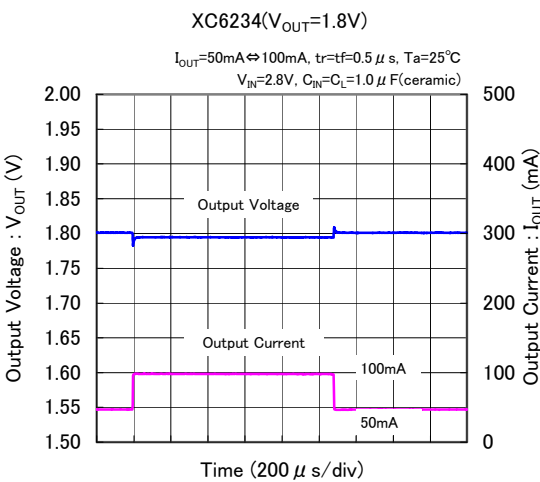
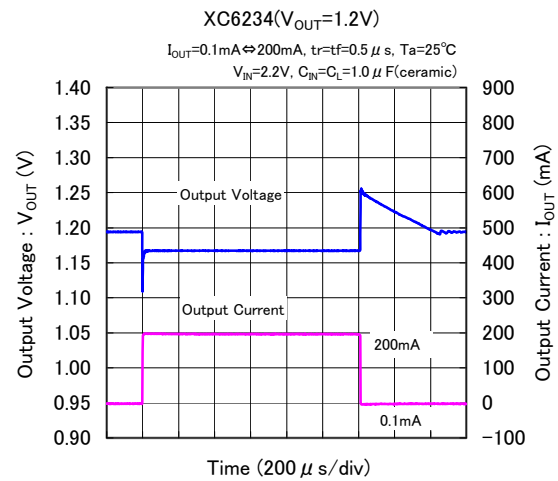
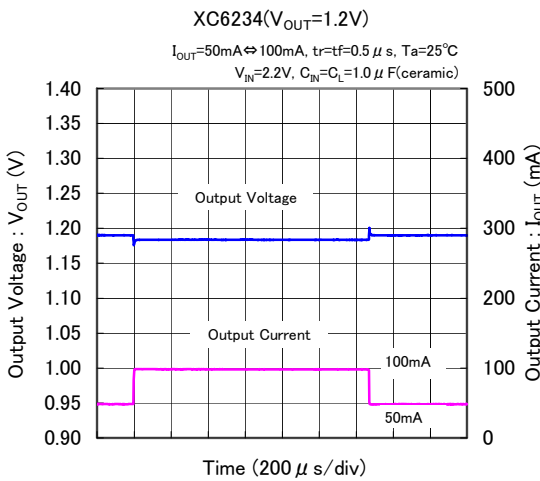

TYPICAL PERFORMANCE CHARACTERISTICS (Continued)

(10) Load Transient Response (Continued)

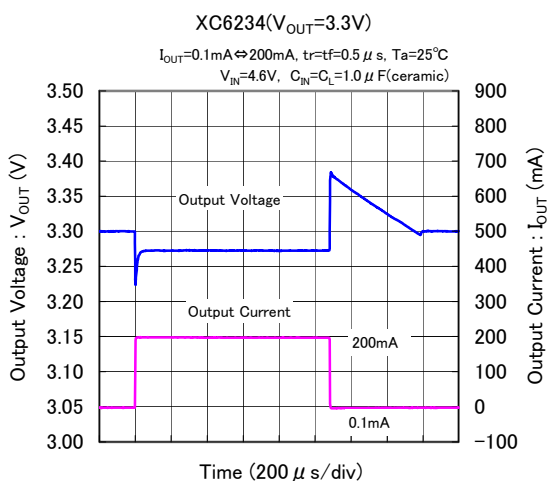
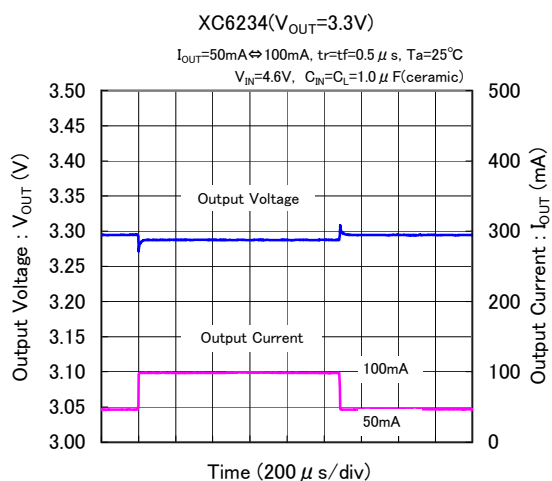
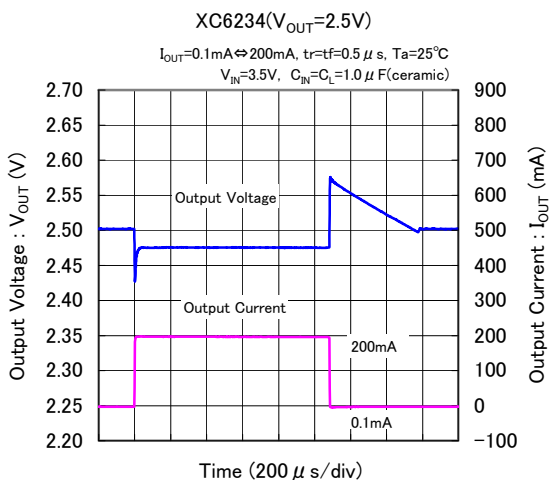
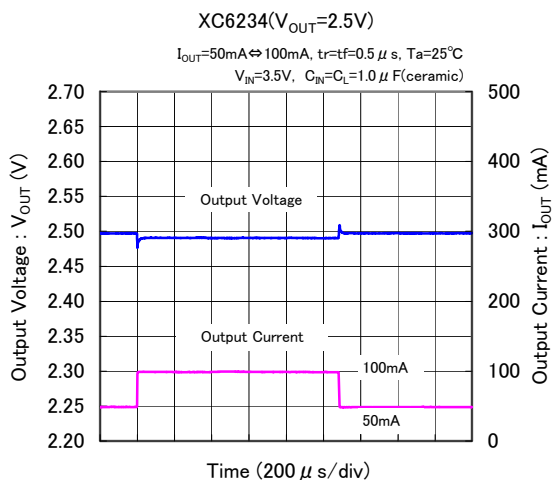

(11) CE Rising Response Time

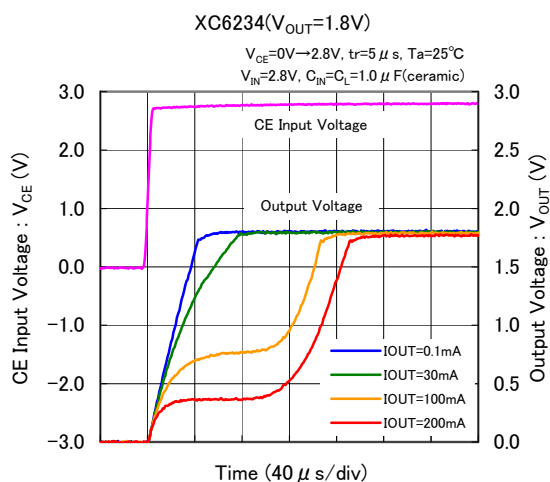
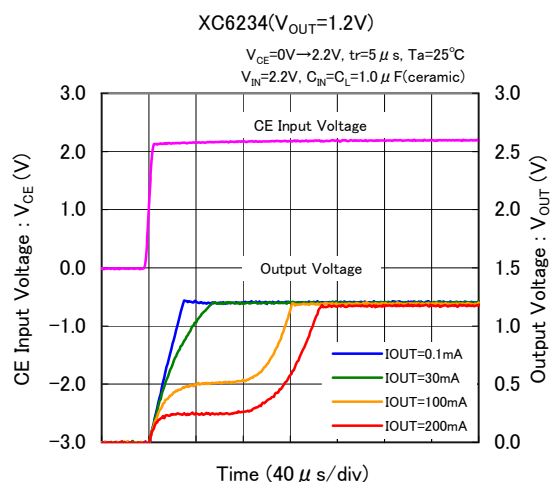

TYPICAL PERFORMANCE CHARACTERISTICS (Continued)

(11) CE Rising Response Time (Continued)

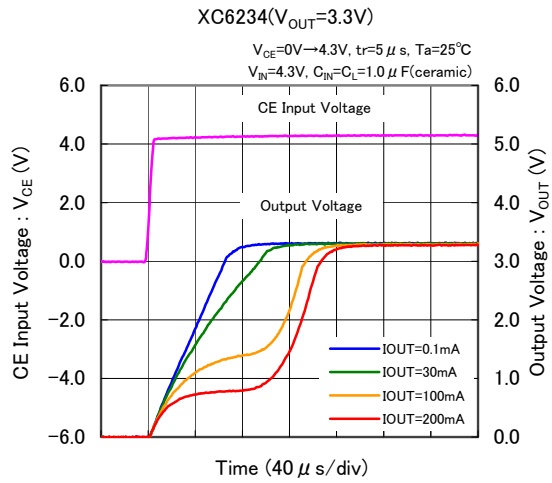
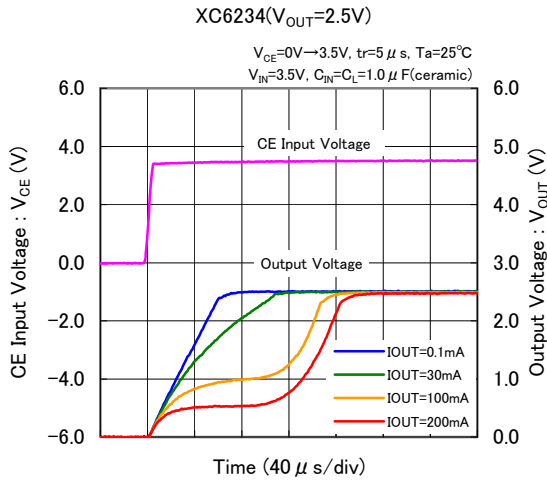

(12) Power Supply Rejection Ratio

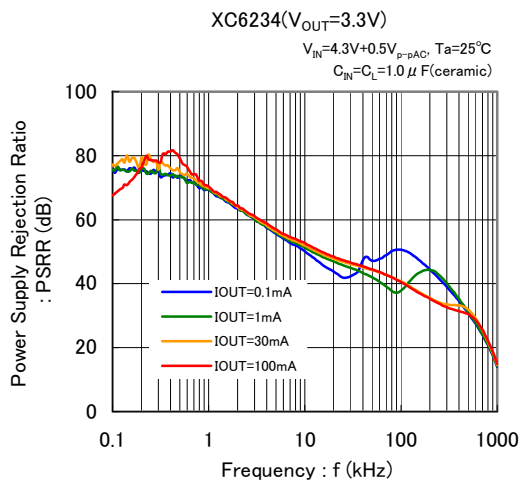
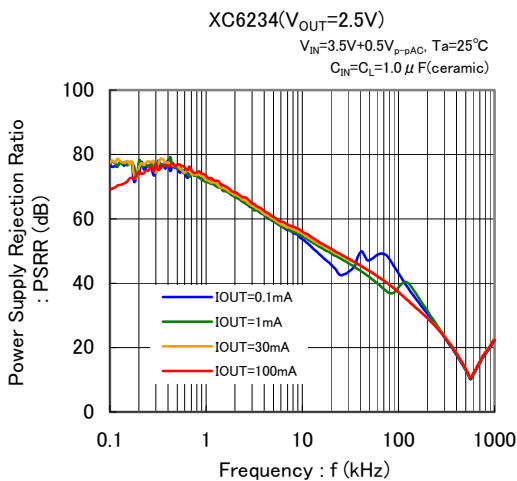
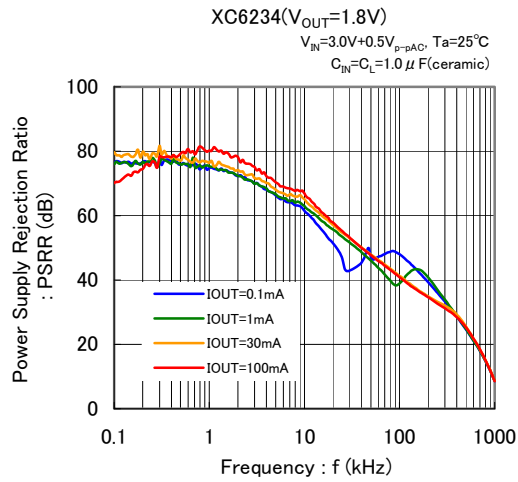
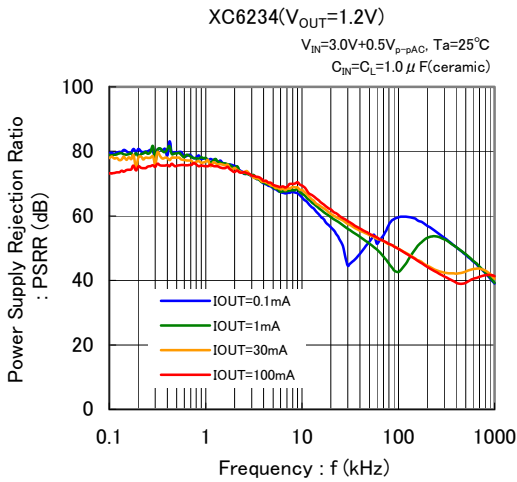

■ TYPICAL PERFORMANCE CHARACTERISTICS (Continued)

(13) Inrush Current Response

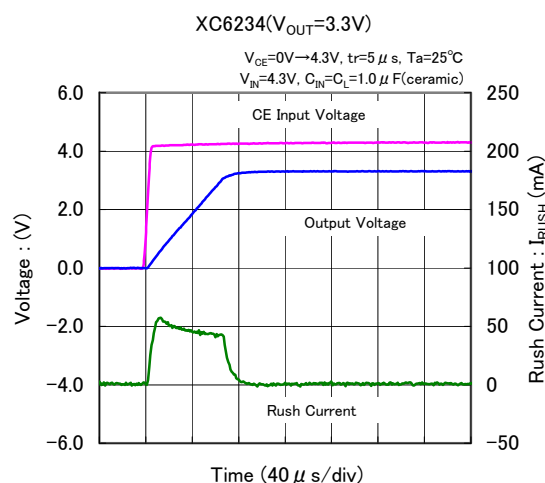
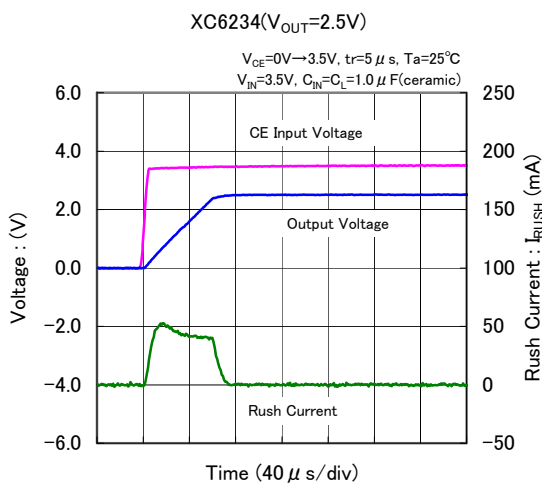
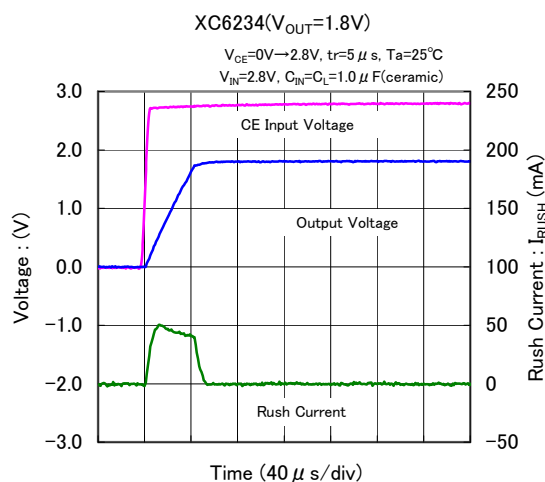
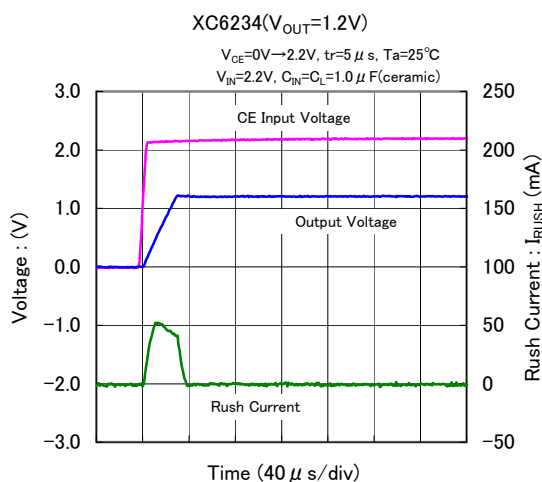

PACKAGING INFORMATION

● SOT-25J (unit: mm)

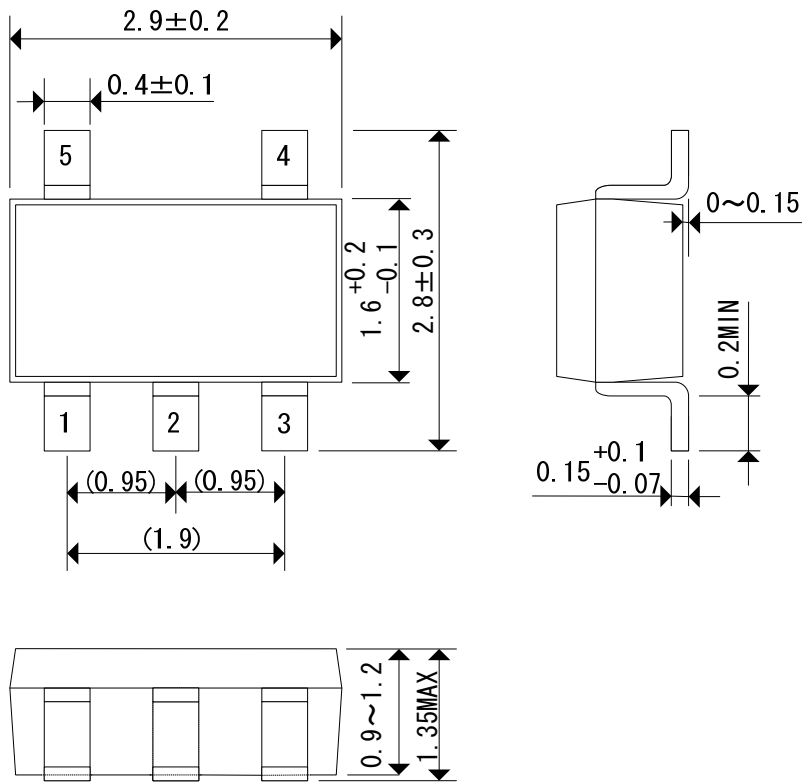

■ PACKAGING INFORMATION (Continued)

● SOT-25J Power Dissipation

Power dissipation data for the SOT-25J is shown in this page.

The value of power dissipation varies with the mount board conditions.

Please use this data as one of reference data taken in the described condition.

1. Measurement Condition (Reference data)

Condition:	Mount on a board
Ambient:	Natural convection
Soldering:	Lead (Pb) free
Board:	Dimensions 40 x 40 mm (1600mm ² in one side) Copper (Cu) traces occupy 50% of the board area In top and back faces Package heat-sink is tied to the copper traces
Material:	Glass Epoxy (FR-4)
Thickness:	1.6 mm
Through-hole:	4 x 0.8 Diameter

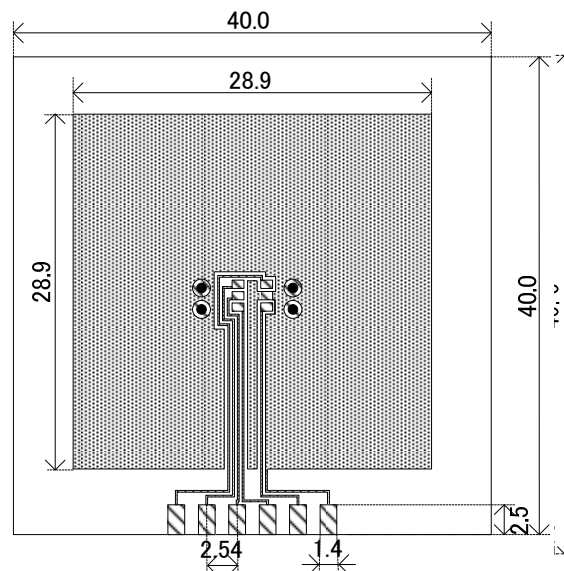

Evaluation Board (Unit: mm)

2. Power Dissipation vs. Ambient Temperature

Board Mount ($T_{jmax}=125^{\circ}\text{C}$)

Ambient Temperature ($^{\circ}\text{C}$)	Power Dissipation Pd (mW)	Thermal Resistance ($^{\circ}\text{C}/\text{W}$)
25	500	200.00
85	200	

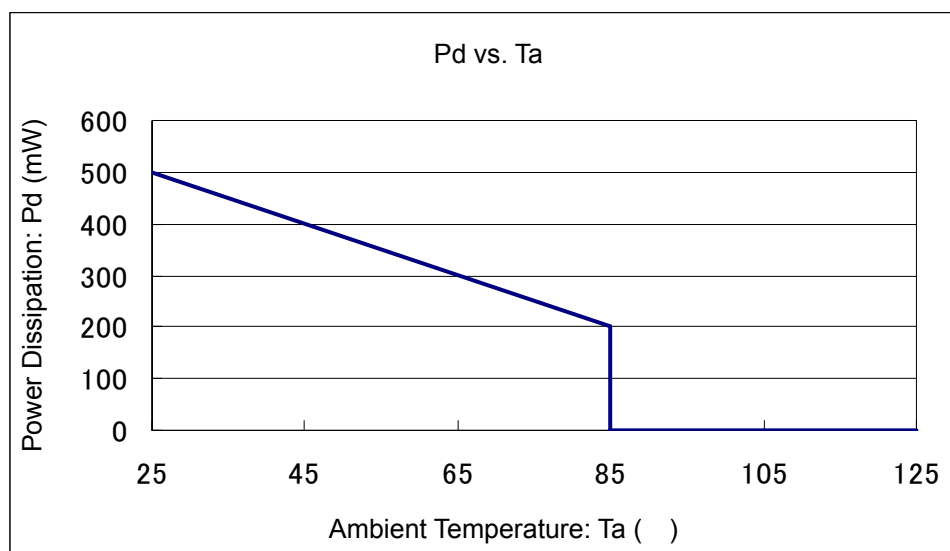

MARKING RULE

SOT-25J (Under dot)

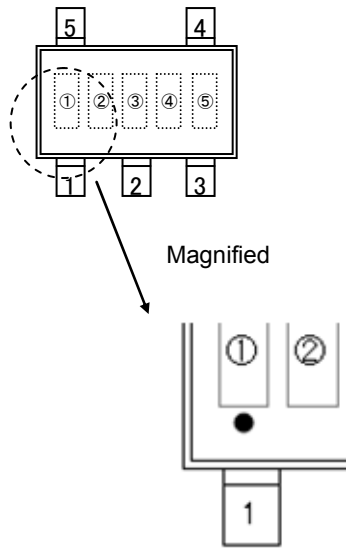

* SOT-25J with the Under dot marking is used.

① represents products series

MARK	PRODUCT SERIES
1	XC6234*****-G

② represents type of regulator

MARK	PRODUCT SERIES
P	XC6234H*****-G

③ represents output voltage

MARK	OUTPUT VOLTAGE (V)
0	1.2
3	1.5
6	1.8
D	2.5
H	2.8
L	3.0
P	3.3

④,⑤ represents production lot number

01~09, 0A~0Z, 11~9Z, A1~A9, AA~AZ, B1~ZZ in order.

(G, I, J, O, Q, W excluded)

*No character inversion used.

1. The products and product specifications contained herein are subject to change without notice to improve performance characteristics. Consult us, or our representatives before use, to confirm that the information in this datasheet is up to date.
2. We assume no responsibility for any infringement of patents, patent rights, or other rights arising from the use of any information and circuitry in this datasheet.
3. Please ensure suitable shipping controls (including fail-safe designs and aging protection) are in force for equipment employing products listed in this datasheet.
4. The products in this datasheet are not developed, designed, or approved for use with such equipment whose failure of malfunction can be reasonably expected to directly endanger the life of, or cause significant injury to, the user.
(e.g. Atomic energy; aerospace; transport; combustion and associated safety equipment thereof.)
5. Please use the products listed in this datasheet within the specified ranges.
Should you wish to use the products under conditions exceeding the specifications, please consult us or our representatives.
6. We assume no responsibility for damage or loss due to abnormal use.
7. All rights reserved. No part of this datasheet may be copied or reproduced without the prior permission of TOREX SEMICONDUCTOR LTD.

TOREX SEMICONDUCTOR LTD.

单击下面可查看定价，库存，交付和生命周期等信息

[>>Torex Semiconductor\(特瑞仕\)](#)