

TOSHIBA CMOS Integrated Circuit Silicon Monolithic

TB6575FNG

PWM Sensorless Controller for 3-Phase Full-Wave BLDC Motors

The TB6575FNG provides sensorless commutation and PWM current control for 3-phase full-wave BLDC motors. It controls rotation speed by changing a PWM duty cycle by analog voltage.

Features

- 3-phase full-wave sensorless drive
- PWM chopper drive
- PWM duty cycle control by analog input
- 20-mA current sink capability on PWM output pins
- Overcurrent protection
- Forward/reverse rotation
- Lead angle control (7.5° and 15°)
- Overlap commutation
- Rotation speed sensing signal
- DC excitation mode to improve startup characteristic
- DC excitation time and forced commutation time for startup operation can be changed.
- Forced commutation frequency can be selected. ($f_{XT}/(6 \times 2^{16})$, $f_{XT}/(6 \times 2^{17})$, $f_{XT}/(6 \times 2^{18})$)
- Output polarity switching (P-channel + N-channel, N-channel + N-channel)

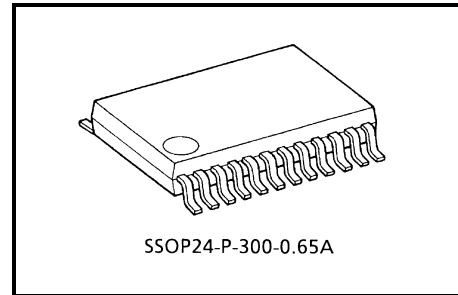

Weight: 0.14 g (typ.)

TB6575FNG is a Pb-free product.

The following conditions apply to solderability:

*Solderability

1. Use of Sn-37Pb solder bath
 - *solder bath temperature = 230°C
 - *dipping time = 5 seconds
 - *number of times = once
 - *use of R-type flux
2. Use of Sn-3.0Ag-0.5Cu solder bath
 - *solder bath temperature = 245°C
 - *dipping time = 5 seconds
 - *number of times = once
 - *use of R-type flux

Block Diagram

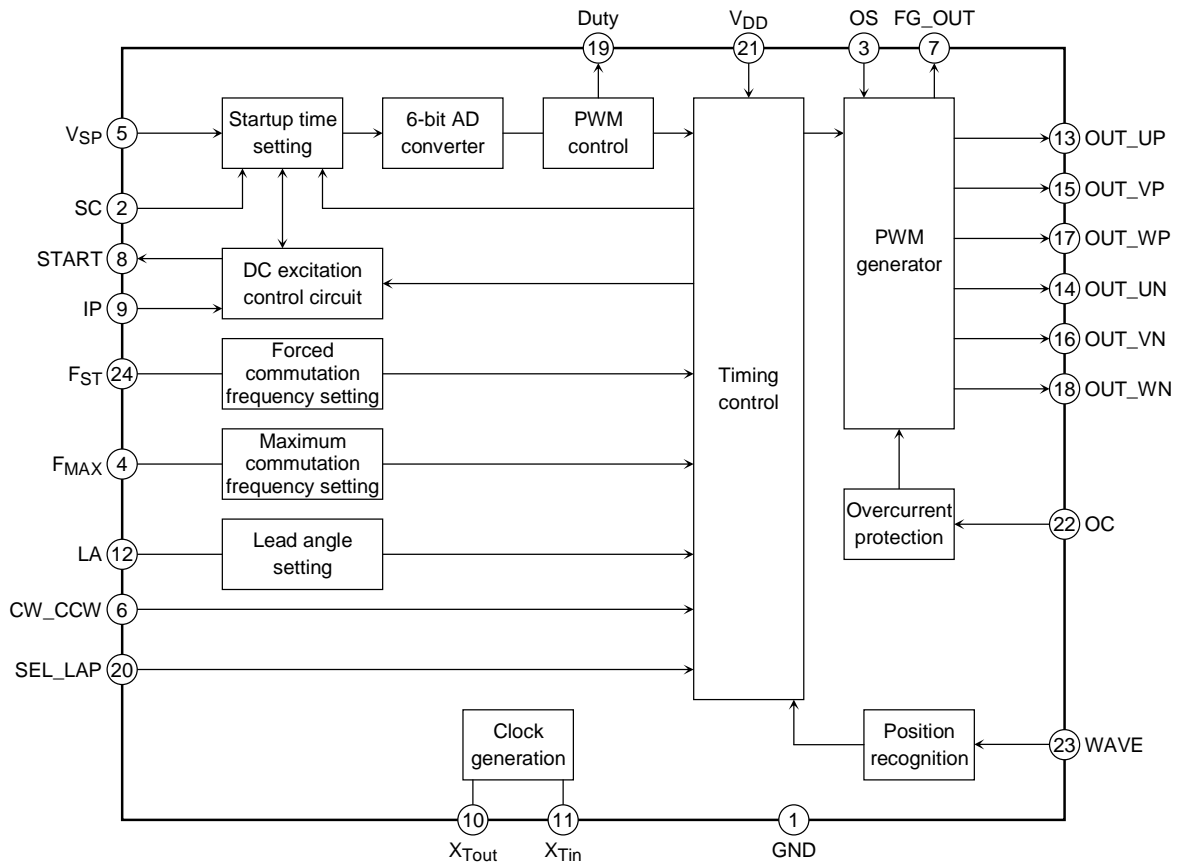

Pin Assignment

GND	1	24	F _{ST}
SC	2	23	WAVE
OS	3	22	OC
F _{MAX}	4	21	V _{DD}
V _{SP}	5	20	SEL_LAP
CW_CCW	6	19	Duty
FG_OUT	7	18	OUT_WN
START	8	17	OUT_WP
IP	9	16	OUT_VN
X _{Tout}	10	15	OUT_VP
X _{Tin}	11	14	OUT_UN
LA	12	13	OUT_UP

Pin Description

Pin No.	Symbol	I/O	Description
1	GND	—	Ground pin
2	SC	I	Connection pin for a capacitor to set a startup commutation time and duty cycle ramp-up time
3	OS	I	Select the polarity of transistors. High or open: High-side transistor = P-channel (active low) Low-side transistor = N-channel (active High) Low: High-side transistor = N-channel (active High) Low-side transistor = N-channel (active High) The pin has a pull-up resistor.
4	F _{MAX}	I	Set an upper limit of the maximum commutation frequency. <Fst=Low> F _{MAX} = High or Open, Maximum commutation frequency $f_{MX} = f_{XT}/(6 \times 2^{11})$ F _{MAX} = Low, Maximum commutation frequency $f_{MX} = f_{XT}/(6 \times 2^{12})$ <Fst=High or Middle> F _{MAX} = High or Open, Maximum commutation frequency $f_{MX} = f_{XT}/(6 \times 2^8)$ F _{MAX} = Low, Maximum commutation frequency $f_{MX} = f_{XT}/(6 \times 2^9)$ The pin has a pull-up resistor.
5	V _{SP}	I	Duty cycle control input 0 ≤ V _{SP} ≤ V _{AD} (L): Output off V _{AD} (L) ≤ V _{SP} ≤ V _{AD} (H): Set the PWM duty cycle according to the analog input. V _{AD} (H) ≤ V _{SP} ≤ V _{DD} : Duty cycle = 100% (31/32) The pin has a pull-down resistor.
6	CW_CCW	I	Rotation direction input High: Reverse rotation (U → W → V) Low or open: Forward rotation (U → V → W) The pin has a pull-down resistor.
7	FG_OUT	O	Rotation speed sensing output The pin is low at startup or upon a detection of a fault. This pin drives three pulses per rotation (3 ppr) based on the back-EMF (electromotive force) sensing. (In the case of 4 pole motor, 6 pulse output per rotation.)
8	START	O	DC excitation time setting pins When V _{SP} ≥ 1 V (typ.), the START pin goes low to start DC excitation. After the IP pin reaches V _{DD} /2, the TB6575FNG moves from DC excitation to forced commutation mode.
9	IP	I	
10	X _{Tout}	—	Connection pins for a ceramic oscillator These pins have a feedback resistor.
11	X _{Tin}	—	
12	LA	I	Lead angle control input LA = Low or open: Lead angle of 7.5° LA = high: Lead angle of 15° The pin has a pull-down resistor.
13	OUT_UP	O	PWM output signal for the high-side (positive-side) transistor driving motor phase U The PWM polarity can be specified by pin 3.
14	OUT_UN	O	PWM output signal for the low-side (negative-side) transistor driving motor phase U This signal is active high.
15	OUT_VP	O	PWM output signal for the high-side (positive-side) transistor driving motor phase V The PWM polarity can be specified by pin 3.
16	OUT_VN	O	PWM output signal for the low-side (negative-side) transistor driving motor phase V This signal is active high.
17	OUT_WP	O	PWM output signal for the high-side (positive-side) transistor driving motor phase W The PWM polarity can be specified by pin 3.
18	OUT_WN	O	PWM output signal for the low-side (negative-side) transistor driving motor phase W This signal is active high.
19	Duty	O	PWM output monitor pin This pin drives PWM output whose duty cycle corresponds to the V _{SP} input. It also reflects the information at the OC pin.
20	SEL_LAP	I	Overlap commutation select pin Low: Overlap commutation High, Open: 120° commutation The pin has a pull-up resistor.

Pin No.	Symbol	I/O	Description
21	V _{DD}	—	5-V power supply pin
22	OC	I	Overcurrent detection input The all PWM output signals are stopped when OC ≥ 0.5 (V). The pin has a pull-up resistor.
23	WAVE	I	Position sensing input Majority logic synthesis signal of 3-phase voltage is applied to this pin. The pin has a pull-up resistor.
24	F _{ST}	I	Forced commutation frequency select pin High or open: Forced commutation frequency $f_{ST} = f_{XT}/(6 \times 2^{16})$ Middle: Forced commutation frequency $f_{ST} = f_{XT}/(6 \times 2^{17})$ Low: Forced commutation frequency $f_{ST} = f_{XT}/(6 \times 2^{18})$ The pin has a pull-up resistor.

Functional Description

1. Sensorless drive

On receiving an analog voltage command input, the rotor is aligned to a known position in DC excitation mode, and then the rotation is started in forced commutation mode by applying a PWM signal to the motor. As the rotor moves, back-EMF is acquired.

When a signal indicating the polarity of each of the phase voltages including back-EMF is applied to the position signal input pin, automatic switching occurs from the forced commutation PWM signal to the natural commutation PWM signal (which is generated based on the back-EMF sensing) to drive a BLDC motor in sensorless mode.

2. Startup operation

When the motor is stationary, there is no back-EMF and the motor position is unknown. For this reason, the rotor is aligned to a known position in DC excitation mode and then the rotation is started in forced commutation mode. An external capacitor sets the times that the TB6575FNG stays in DC excitation and forced commutation modes. Those times vary depending on the motor type and motor loading. Thus, they must be adjusted experimentally.

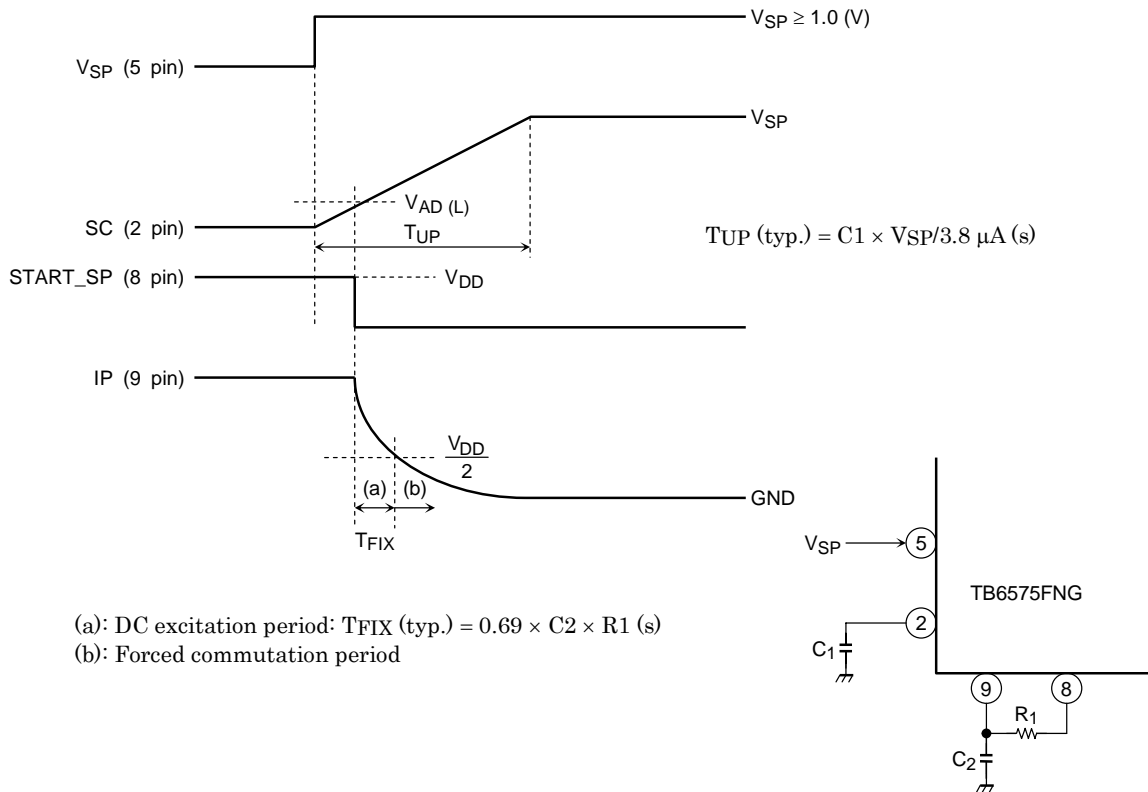

The rotor is aligned to a known position in DC excitation mode for period (a), during which the IP pin voltage decreases to half V_{DD} level. The time constant for the period is determined by C_2 and R_1 . After that, switching occurs to forced commutation mode represented by (b). The duty cycles for DC excitation and forced commutation modes are determined according to the SC pin voltage. When the rotation frequency of the motor exceeds the forced commutation frequency, the motor switches to sensorless mode. The duty cycle for sensorless mode is determined by the SC pin voltage.

3. SC Signal Delay in Rotational Speed Control (V_{SP} Follow-Up Property)

The V_{SP} input is used to control the motor speed; the TB6575FNG allows the motor to start, stop and change the speed according to the voltage at V_{SP}. However, the actual operation of the IC is determined by the voltage applied to the SC input. The voltage at the SC input equals the charging voltage of the capacitor C1, which depends on its charging and discharging times. This causes a delay in the rise and fall times of the SC voltage level. The following figure shows the SC delay that occurs when V_{SP} changes between 1 V and 4 V.

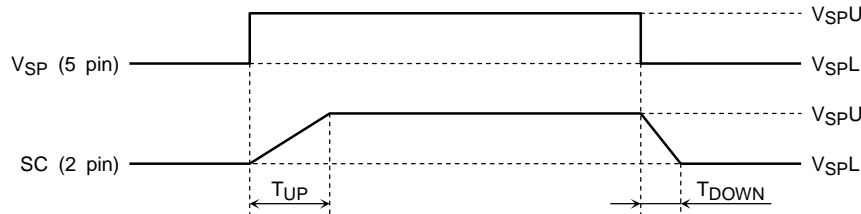

- Charging time of SC (for acceleration): $T_{UP} (typ.) = C_1 \times (V_{SPU} - V_{SPL}) / 3.8 \mu A (s)$
- Discharging time of SC (for deceleration): $T_{DOWN} (typ.) = C_1 \times (V_{SPU} - V_{SPL}) / 36 \mu A (s)$

* When the motor is stopped (V_{SP} < 1 V), the capacitor C1 connected to the SC input discharges instantaneously. (C1 is discharged to GND through a 2-kΩ resistor.)

4. Forced commutation frequency

The forced commutation frequency for startup operation is set as follows.

The optimal frequency varies depending on the motor type and motor loading. Thus, it must be adjusted experimentally.

F_{ST} = High or Open: Forced commutation frequency $f_{ST} = f_{XT} / (6 \times 2^{16})$

F_{ST} = Middle: Forced commutation frequency $f_{ST} = f_{XT} / (6 \times 2^{17})$

F_{ST} = Low: Forced commutation frequency $f_{ST} = f_{XT} / (6 \times 2^{18})$

* f_{XT}: Ceramic oscillator frequency

5. PWM frequency

The PWM frequency is determined by an external oscillator.

PWM frequency (f_{PWM}) = $f_{XT} / 256$

* f_{XT}: Ceramic oscillator frequency

The PWM frequency must be sufficiently high, compared with the electrical frequency of the motor and within the switching performance of the transistors.

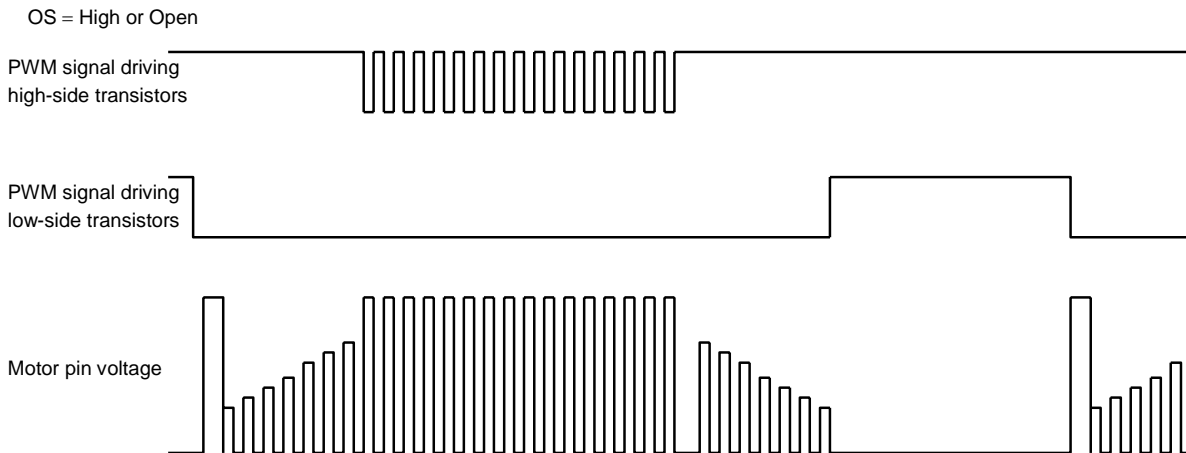

6. Speed control V_{SP} pin

An analog voltage applied to the V_{SP} pin is converted by the 6-bit AD converter to control the duty cycle of the PWM.

- 0 ≤ V_{DUTY} ≤ V_{AD} (L)
→ Duty cycle = 0%
- V_{AD} (L) ≤ V_{DUTY} ≤ V_{AD} (H)
→ Figure at the right (1/64 to 63/64)
- V_{AD} (H) ≤ V_{DUTY} ≤ V_{DD}
→ Duty cycle = 100% (63/64)

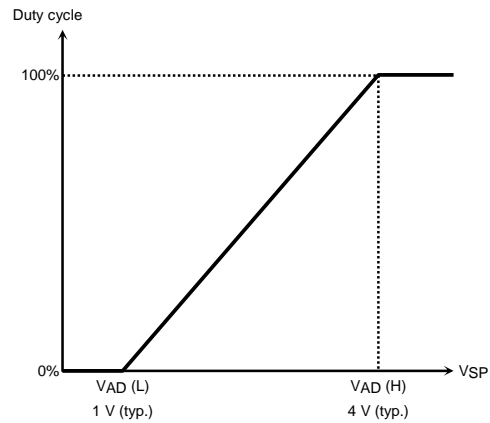

7. Fault protection

When a signal indicating the following faults is applied to the WAVE pin, the output transistors are disabled. After about one second, the motor is restarted. This operation is repeated as long as a fault is detected.

- The maximum commutation frequency is exceeded.
- The rotation speed falls below the forced commutation frequency.

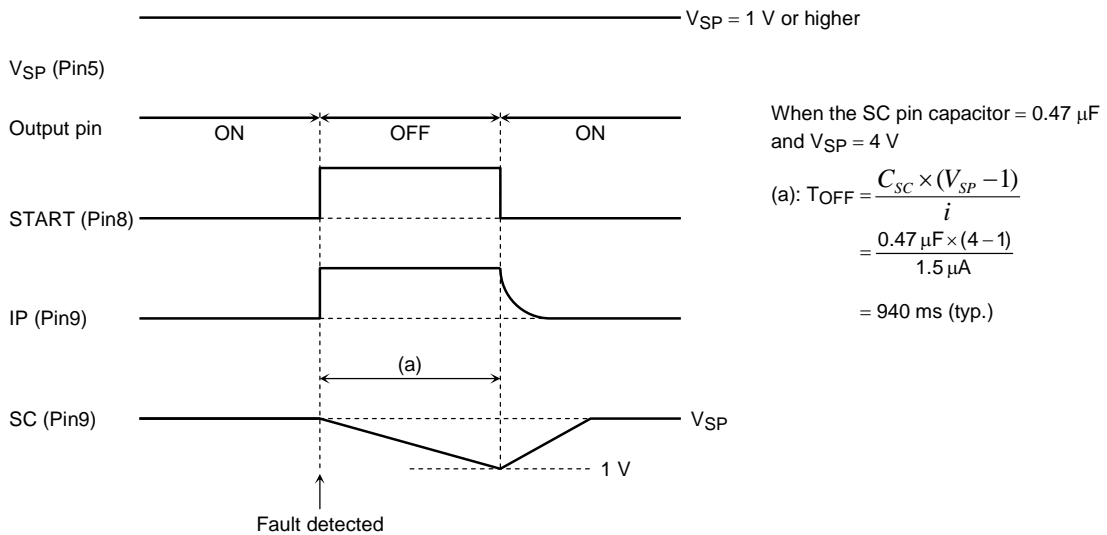

8. Motor position detection error

A position detection is synchronized with the PWM signal generated in the IC. Thus, a position detection error relative to the PWM signal frequency may occur. Keep this in mind especially when the TB6575FNG is used for a high-speed motor.

A detection is performed on the falling edge of the PWM signal. An error is recognized when the pin voltage exceeds the reference voltage.

Detection error time $< 1/f_p$ f_p : PWM frequency = $f_{XT}/256$ f_{XT} : Ceramic oscillator frequency

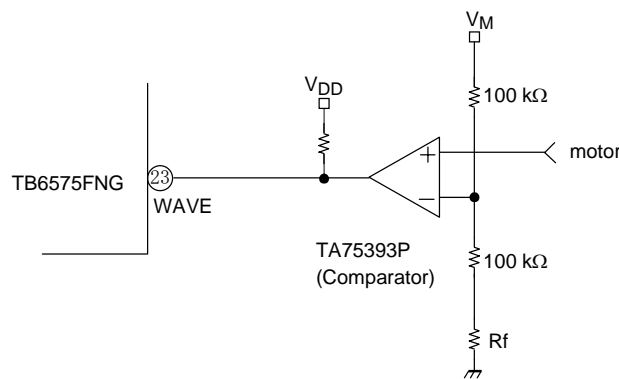
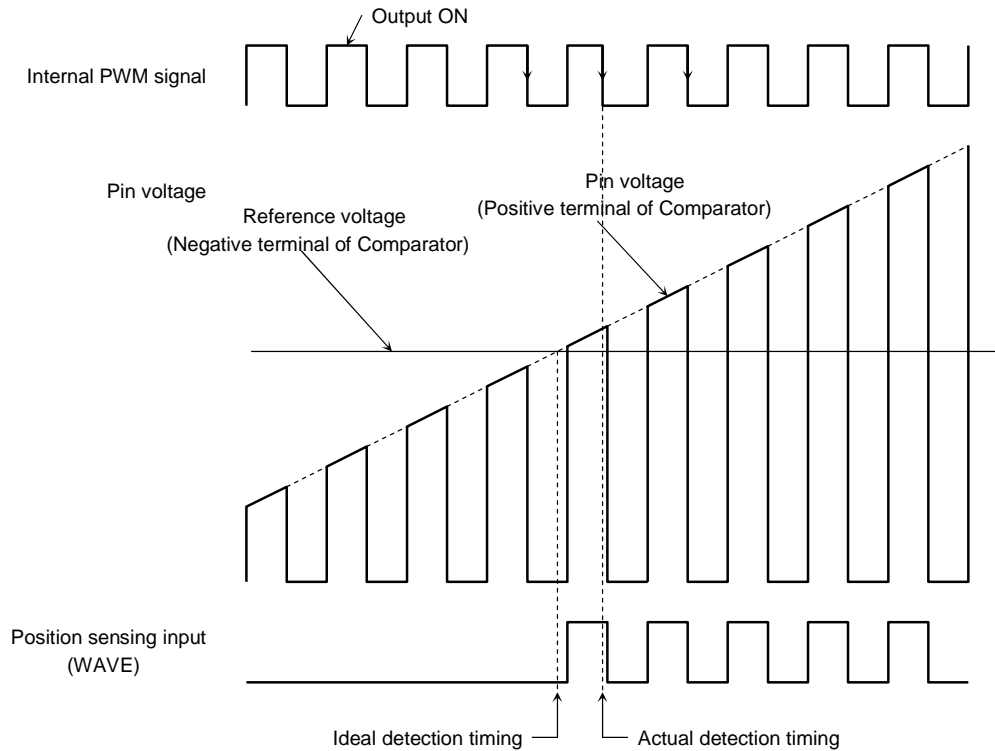

9. Lead angle control

The motor runs with a lead angle of 0° in forced commutation mode at startup. After switching to natural commutation, the lead angle automatically changes to the value set by the LA pin.

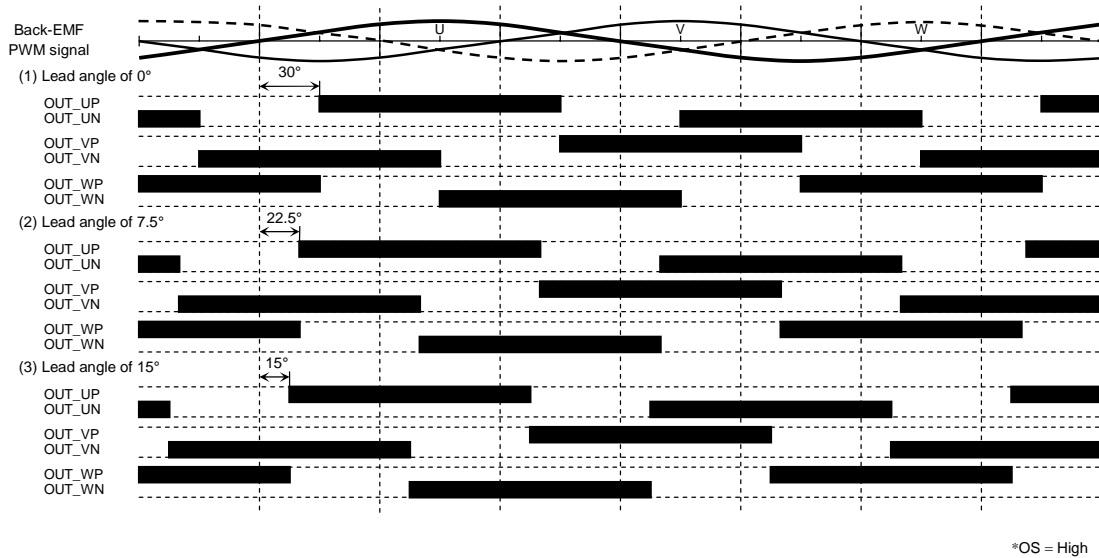

10. Overlap commutation

When SEL_LAP = high, the TB6575FNG is configured to allow for 120° commutation. When SEL_LAP = low, it is configured to allow for overlap commutation. In overlap commutation, there is an overlap period during which both the outgoing transistor and incoming transistor are conducting (as shown in the shaded areas). This period varies according to the lead angle.

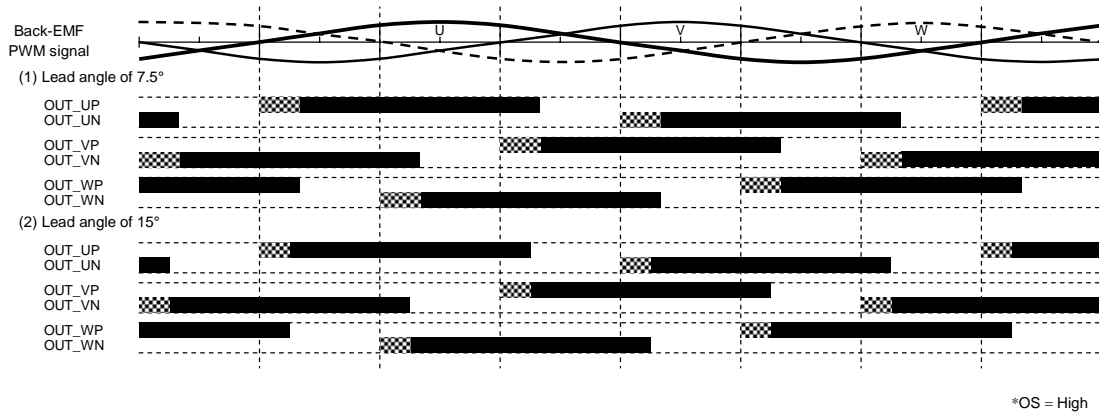

Absolute Maximum Ratings (Ta = 25°C)

Characteristics	Symbol	Rating	Unit
Power supply voltage	V _{DD}	5.5	V
Input voltage	V _{in}	-0.3 to V _{DD} + 0.3	V
Turn-on signal output current	I _{OUT}	20	mA
Power dissipation	P _D	780 (Note)	mW
Operating temperature	T _{opr}	-30 to 105	°C
Storage temperature	T _{stg}	-55 to 150	°C

Note: Without a PCB, stand-alone operation

Operating Conditions (Ta = -30 to 105°C)

Characteristics	Symbol	Test Condition	Min	Typ.	Max	Unit
Power supply voltage	V _{DD}	—	4.5	5.0	5.5	V
Input voltage	V _{in}	—	-0.3	—	V _{DD} + 0.3	V
Oscillation frequency	f _{XT}	—	2.0	4.0	8.0	MHz

Electrical Characteristics (Ta = 25°C, VDD = 5 V)

Characteristics	Symbol	Test Circuit	Test Condition	Min	Typ.	Max	Unit
Rest power supply current	I _{DD}	—	V _{SP} = 0 V, X _{Tin} = H	—	0.7	1	mA
Operating power supply current	I _{DD (opr)}	—	V _{SP} = 2.5 V, X _{Tin} = 4 MHz, Output open	—	2	6	mA
Input current	I _{IN-1 (H)}	—	V _{IN} = 5 V, OC, WAVE, SEL_LAP, F _{MAX} , F _{ST} , OS	—	0	1	μA
	I _{IN-1 (L)}	—	V _{IN} = 0 V, OC, WAVE, SEL_LAP, F _{MAX} , F _{ST} , OS	-75	-50	—	
	I _{IN-2 (H)}	—	V _{IN} = 5 V, CW_CCW, LA, V _{SP}	—	50	75	
	I _{IN-2 (L)}	—	V _{IN} = 0 V, CW_CCW, LA, V _{SP}	-1	0	—	
	I _{IN-3 (H)}	—	V _{IN} = 5 V, V _{SP}				
	I _{IN-3 (L)}	—	V _{IN} = 0 V, V _{SP}				
Input voltage	V _{IN-1 (H)}	—	OC, SEL_LAP, CW_CCW, WAVE, LA, F _{MAX} , OS	3.5	—	5	V
	V _{IN-1 (L)}	—	OC, SEL_LAP, CW_CCW, WAVE, LA, F _{MAX} , OS	GND	—	1.5	
	V _{IN-2 (H)}	—	F _{ST}	4	—	5	
	V _{IN-2 (M)}	—	F _{ST}	2	—	3	
	V _{IN-2 (L)}	—	F _{ST}	GND	—	1	
Input hysteresis voltage	V _H	—	WAVE, IP	—	0.45	—	V
Output voltage	V _{O-1 (H)}	—	I _{OH} = -2 mA, OUT_UP, OUT_VP, OUT_WP	4.5	—	V _{DD}	V
	V _{O-1 (L)}	—	I _{OL} = 20 mA, OUT_UP, OUT_VP, OUT_WP	GND	—	0.5	
	V _{O-2 (H)}	—	I _{OH} = -20 mA, OUT_UN, OUT_VN, OUT_WN	4.5	—	V _{DD}	
	V _{O-2 (L)}	—	I _{OL} = 2 mA, OUT_UN, OUT_VN, OUT_WN	GND	—	0.5	
	V _{O-3 (H)}	—	I _{OH} = -0.5 mA, FG_OUT	4.5	—	V _{DD}	
	V _{O-3 (L)}	—	I _{OL} = 0.5 mA, FG_OUT	GND	—	0.5	
Output leak current	I _{L (H)}	—	V _{DD} = 5.5 V, V _{OUT} = 0 V, OUT_UP, OUT_VP, OUT_WP, OUT_UN, OUT_VN, OUT_WN, FG_OUT	—	0	10	μA
	I _{L (L)}	—	V _{DD} = 5.5 V, V _{OUT} = 5.5 V, OUT_UP, OUT_VP, OUT_WP, OUT_UN, OUT_VN, OUT_WN, FG_OUT	—	0	10	
PWM input voltage	V _{AD (L)}	—	V _{SP}	0.8	1.0	1.2	V
	V _{AD (H)}			3.8	4.0	4.2	
C _{SC} charge current	I _{SC}	—	SC	2.6	3.8	5.0	μA
Fault retry time	T _{OFF}	—	V _{SP} = 4 V, SC pin = 0.47 μF	—	940	—	ms
Overcurrent detection voltage	V _{OC}	—	OC	0.46	0.5	0.54	V

Input Equivalent Circuit

1. VSP pin

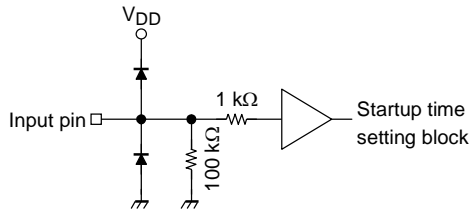

2. SEL_LAP, FMAX, FST, WAVE and OS pins

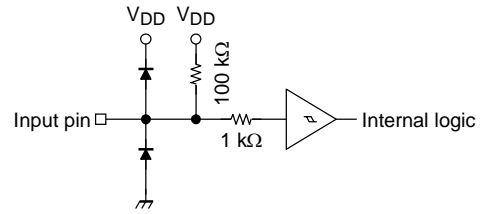

Hysteresis width
WAVE: 450 mV (typ.)

3. LA and CW_CCW pins

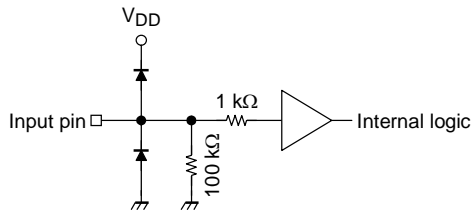

4. OUT_UP, OUT_UN, OUT_VP, OUT_VN, OUT_WP, OUT_WN and FG_OUT pins

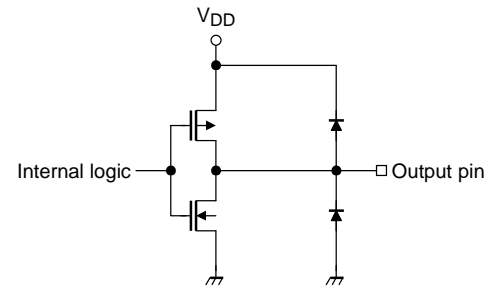

5. XTin and XTout pins

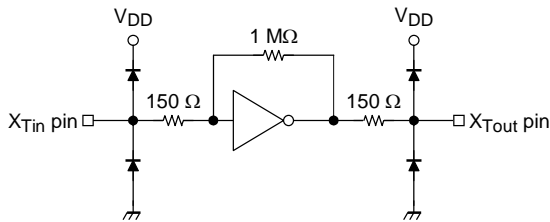

6. OC pin

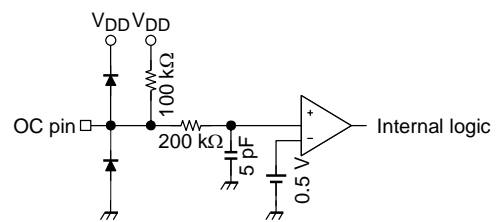

Application Circuit Example

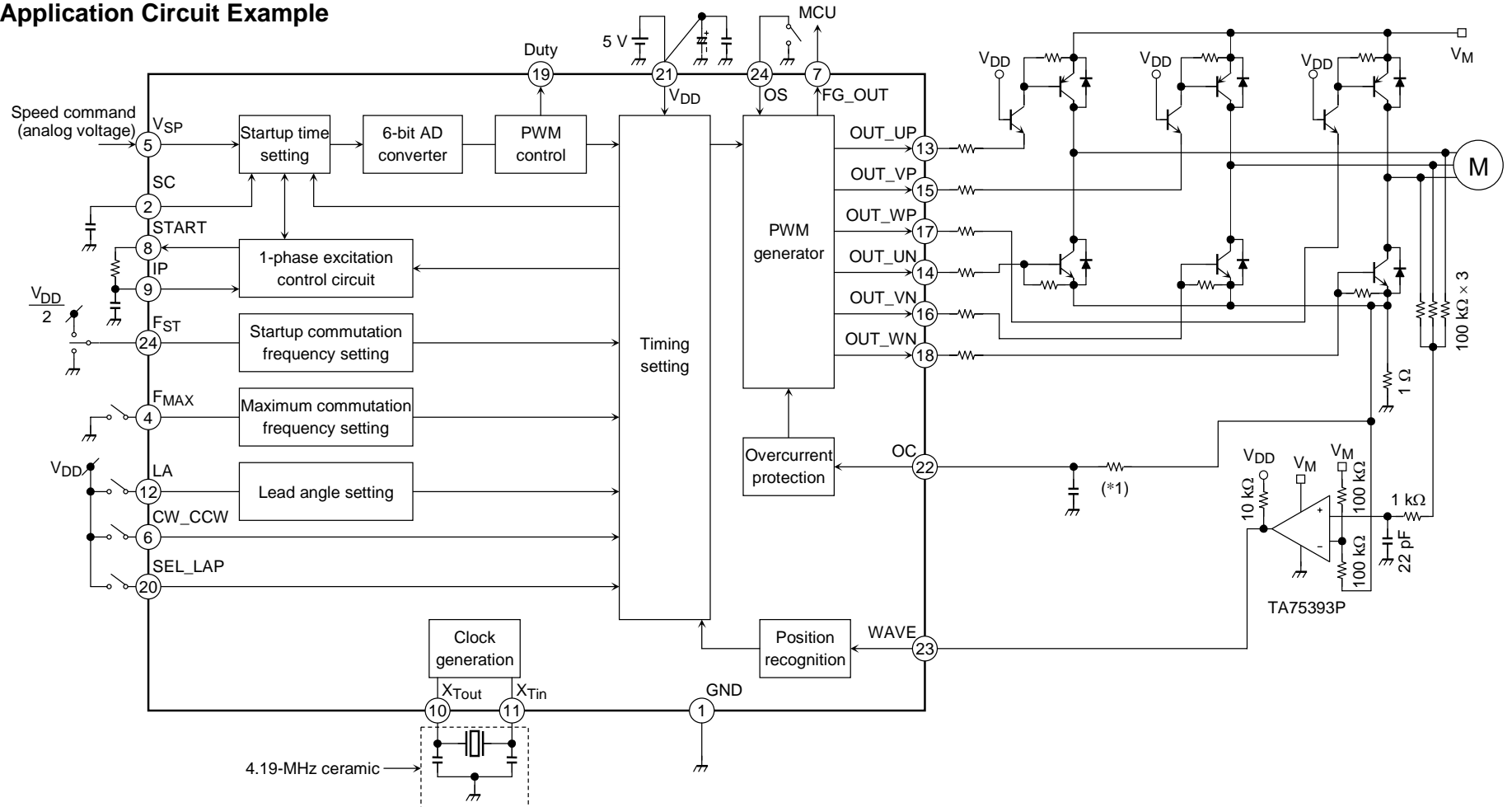

Note 1: Utmost care is necessary in the design of the output, V_{CC} , V_M , and GND lines since the IC may be destroyed by short-circuiting between outputs, air contamination faults, or faults due to improper grounding, or by short-circuiting between contiguous pins.

Note 2: The above application circuit including component values is reference only. Because the values may vary depending on the motor type, the optimal values must be determined experimentally.

*1: Connect a resistor, if necessary, to prevent malfunction due to noise.

Package Dimensions

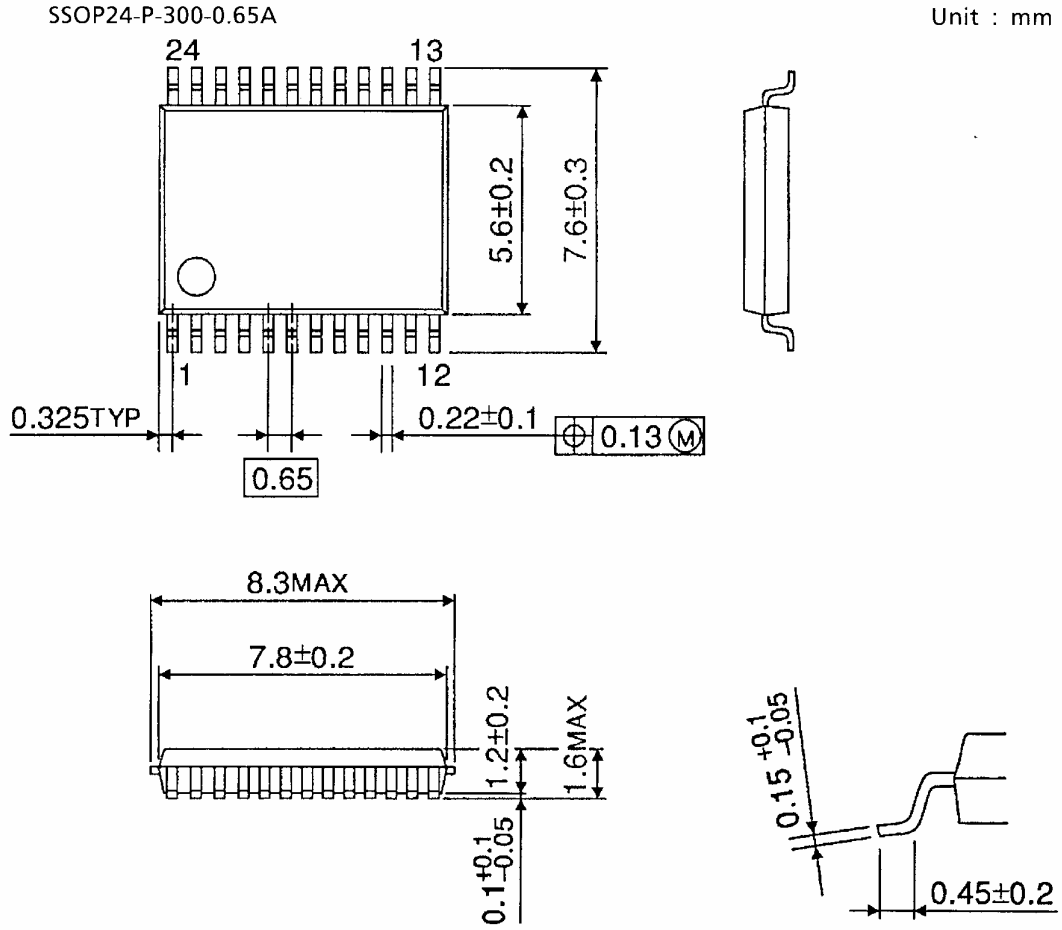

Weight: 0.14 g (typ.)

Notes on Contents**1. Block Diagrams**

Some of the functional blocks, circuits, or constants in the block diagram may be omitted or simplified for explanatory purposes.

2. Equivalent Circuits

The equivalent circuit diagrams may be simplified or some parts of them may be omitted for explanatory purposes.

3. Timing Charts

Timing charts may be simplified for explanatory purposes.

4. Application Circuits

The application circuits shown in this document are provided for reference purposes only. Thorough evaluation is required, especially at the mass production design stage.

Toshiba does not grant any license to any industrial property rights by providing these examples of application circuits.

5. Test Circuits

Components in the test circuits are used only to obtain and confirm the device characteristics. These components and circuits are not guaranteed to prevent malfunction or failure from occurring in the application equipment.

IC Usage Considerations**Notes on handling of ICs**

- [1] The absolute maximum ratings of a semiconductor device are a set of ratings that must not be exceeded, even for a moment. Do not exceed any of these ratings.
Exceeding the rating(s) may cause the device breakdown, damage or deterioration, and may result injury by explosion or combustion.
- [2] Do not insert devices in the wrong orientation or incorrectly.
Make sure that the positive and negative terminals of power supplies are connected properly. Otherwise, the current or power consumption may exceed the absolute maximum rating, and exceeding the rating(s) may cause the device breakdown, damage or deterioration, and may result injury by explosion or combustion.
In addition, do not use any device that is applied the current with inserting in the wrong orientation or incorrectly even just one time.

RESTRICTIONS ON PRODUCT USE

20070701-EN GENERAL

- The information contained herein is subject to change without notice.
- TOSHIBA is continually working to improve the quality and reliability of its products. Nevertheless, semiconductor devices in general can malfunction or fail due to their inherent electrical sensitivity and vulnerability to physical stress. It is the responsibility of the buyer, when utilizing TOSHIBA products, to comply with the standards of safety in making a safe design for the entire system, and to avoid situations in which a malfunction or failure of such TOSHIBA products could cause loss of human life, bodily injury or damage to property.
In developing your designs, please ensure that TOSHIBA products are used within specified operating ranges as set forth in the most recent TOSHIBA products specifications. Also, please keep in mind the precautions and conditions set forth in the "Handling Guide for Semiconductor Devices," or "TOSHIBA Semiconductor Reliability Handbook" etc.
- The TOSHIBA products listed in this document are intended for usage in general electronics applications (computer, personal equipment, office equipment, measuring equipment, industrial robotics, domestic appliances, etc.). These TOSHIBA products are neither intended nor warranted for usage in equipment that requires extraordinarily high quality and/or reliability or a malfunction or failure of which may cause loss of human life or bodily injury ("Unintended Usage"). Unintended Usage include atomic energy control instruments, airplane or spaceship instruments, transportation instruments, traffic signal instruments, combustion control instruments, medical instruments, all types of safety devices, etc.. Unintended Usage of TOSHIBA products listed in this document shall be made at the customer's own risk.
- The products described in this document shall not be used or embedded to any downstream products of which manufacture, use and/or sale are prohibited under any applicable laws and regulations.
- The information contained herein is presented only as a guide for the applications of our products. No responsibility is assumed by TOSHIBA for any infringements of patents or other rights of the third parties which may result from its use. No license is granted by implication or otherwise under any patents or other rights of TOSHIBA or the third parties.
- Please contact your sales representative for product-by-product details in this document regarding RoHS compatibility. Please use these products in this document in compliance with all applicable laws and regulations that regulate the inclusion or use of controlled substances. Toshiba assumes no liability for damage or losses occurring as a result of noncompliance with applicable laws and regulations.

单击下面可查看定价，库存，交付和生命周期等信息

[>>Toshiba\(东芝\)](#)