

All information is subject to change without notice. Please read bottom notes.

FEATURES

- (1) 8.4" SVGA color display with High Brightness
- (2) Built in Long Life CCFLs (MTBF:50,000 h).
(Conditions / T_a :25°C I_{FL} :6.0mA (rms)(continuing lighting), f_{FL} :40kHz)
- (3) Replaceable structure of lamp units.
- (4) Mounting compatible with LTM08C351 series.
- (5) Resistance type touch panel assemble(4 wire, Except controller)

TENTATIVE**RoHS compatible****MECHANICAL SPECIFICATIONS**

Item	Specifications
Dimensional Outline (Typ.)	199.5 (W) x 149.5 (H) x 13.0 (D) mm
Number of Pixels	800 (W) x 600 (H) pixels
Active Area	170.4 (W) x 127.8 (H) mm
Pixel Pitch	0.213 (W) x 0.213 (H)
Weight (approximately)	(540g)
Backlight	Sidelight (2 CCFLs)

ABSOLUTE MAXIMUM RATINGS

Item	Min.	Max.	Unit	
Supply Voltage	(V_{DD})	-0.3	4.0	V
	(V_{FL})	0	2.0	kV(rms)
FL Driving Frequency	(f_{FL})	---	100	kHz
Input Signal Voltage	(V_{IN})	-0.3	$V_{DD}+0.3$	V
Operating Temperature		-20	70	°C
Storage Temperature		-30	80	°C
Storage Humidity (Max. wet bulb temp. = 39°C)		10	90	%(RH)

ELECTRICAL SPECIFICATION (RECOMMENDED OPERATION CONDITION)

Item	Min.	Typ.	Max.	Unit	Remarks	
Supply Voltage	(V_{DD})	3.0	3.3	3.6	V	
	(V_{FL})	---	430	---	V(rms)	$I_{FL}=6.0$ mA(rms)
FL Start Voltage	(V_{SFL})	1300	---	1600	V(rms)	$T_a=0$ °C
Differential Input Voltage	(V_{ID})	0.1	---	0.6	V	
Common Mode Input Voltage	(V_{CM})	1.0	1.25	$2.4-(V_{ID})/2$	V	
High Level Input Voltage	(V_{IH})	2.0	---	V_{DD}	V	REV
Low Level Input Voltage	(V_{IL})	0	---	0.8	V	REV
Current Consumption	(I_{DD}) ^{*1}	---	225	---	mA	
	(I_{FL}) ^{*2}	4.0	6.0	6.5	mA(rms)	
Power Consumption ^{*1*2}	---	5.9	---	W	$I_{FL}=6.0$ mA(rms)	

*1 : 8 color bars pattern *2 : Excepting the efficiency FL inverter

OPTICAL SPECIFICATION ($T_a=25$ °C)

Item	Min.	Typ.	Max.	Unit	Remarks
Contrast Ratio	(CR)	250	450	---	Without T/P
Viewing Angle (CR ≥ 10)	(Upper+Lower)	---	100	---	° Without T/P
	(Left+Right)	---	120	---	° Without T/P
Response Time	(t_{ON})	---	8	---	ms
	(t_{OFF})	---	17	---	ms
Luminance	(L)	250	320	---	cd/m ² $I_{FL}=6.0$ mA(rms)
Lamp Life Time (MTBF) ^{*3*4}		50,000		h	

*3 : Conditions ; $T_a=25$ °C, $I_{FL}=6.0$ mA(rms), continuous lighting

*4 : Definitions of failure ; 1) Lcd luminance becomes half of the minimum value. 2) Lamp doesn't light normally.

*The information contained herein is presented only as a guide for the applications of our products. No responsibility is assumed by Toshiba Mobile Display Co., Ltd or other rights of the third parties which may result from its use. No license is granted by implication or otherwise under any patent or patent rights of Toshiba Mobile Display Co., Ltd or others.

*The information contained herein may be changed without prior notice. It is therefore advisable to contact Toshiba Mobile Display Co., Ltd before proceeding with the design of equipment incorporating this product.

<Touch Panel Condition>

Recommended Operating Conditions

Item		Min.	Typ.	Max.	Unit	Remarks
Supply Voltage	V_{TP}	---	5.0	7.0	V	

Electrical Specifications

Item		Min.	Typ.	Max.	Unit	Remarks	
Insulation Resistance	Z	20	---	---	MOhm	DC25V	
Resistance between Terminals	#1 - #3(X)	R_x	200	---	1500	Ohm	Measured at connector pin(including conductor resistance).
	#2 - #4(Y)	R_y	100	---	1200		
Linearity	-	---	---	4.0	%		
Chattering	-	---	---	15	msec		

Mechanical Specifications

Item		Min.	Typ.	Max.	Unit	Remarks
Operating Starting Force		0.05	---	0.8	N	Finger input
Surface Hardness		3	---	---	H	

DIMENSIONAL OUTLINE (front)

TENTATIVE

Unit : mm
Standard tolerance : 0.5

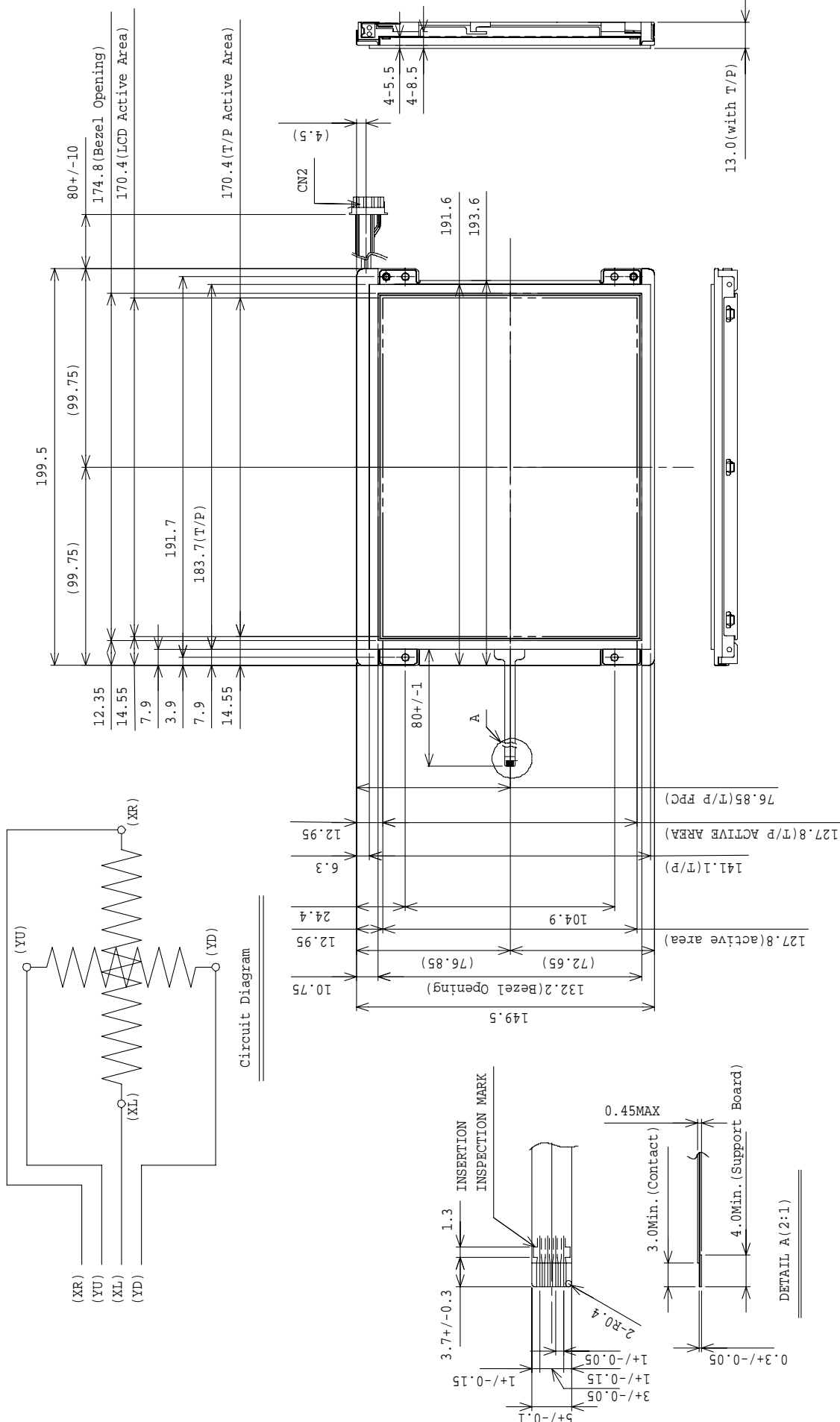

TENTATIVE

DIMENSIONAL OUTLINE (rear)

Unit : mm

Standard tolerance : 0.5

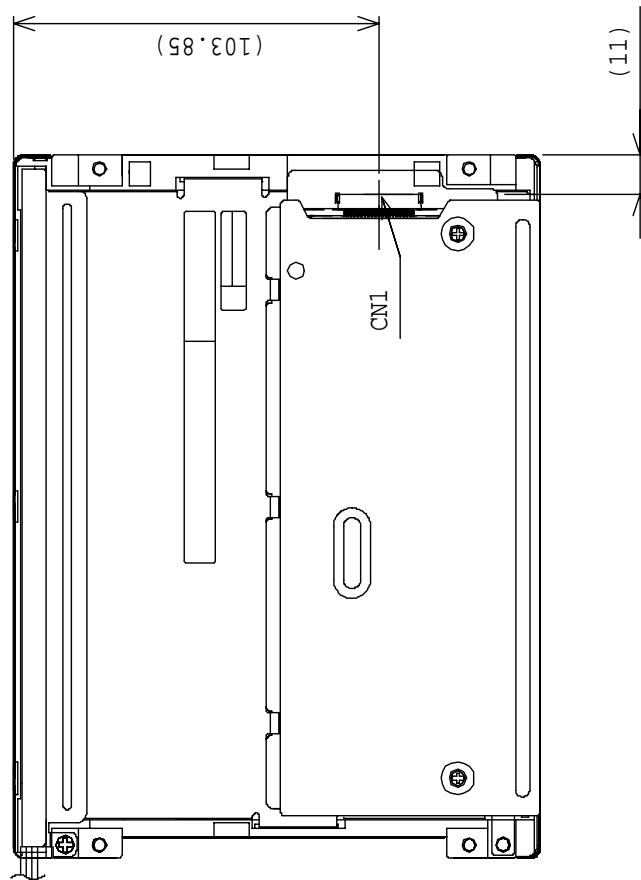

BLOCK DIAGRAM

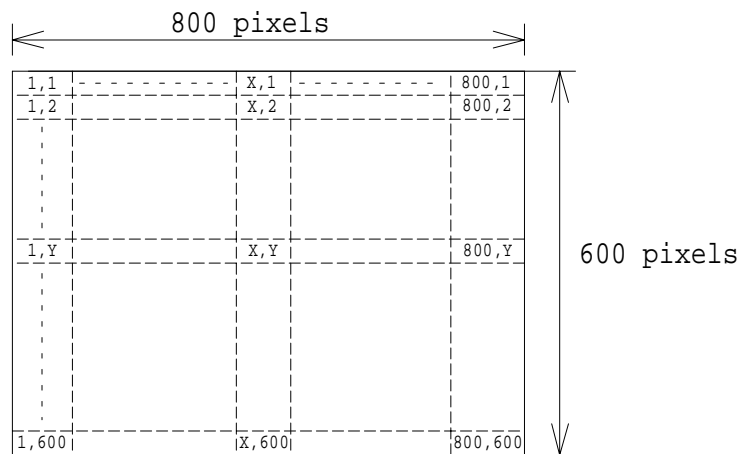
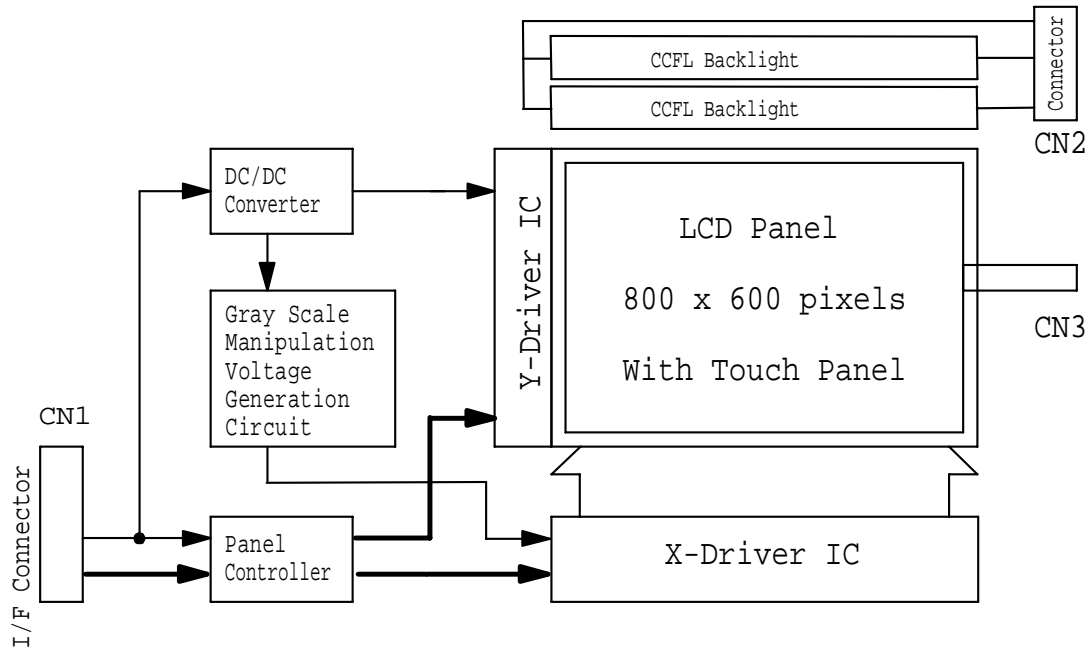

SEQUENCE OF POWER SUPPLIES AND SIGNALS

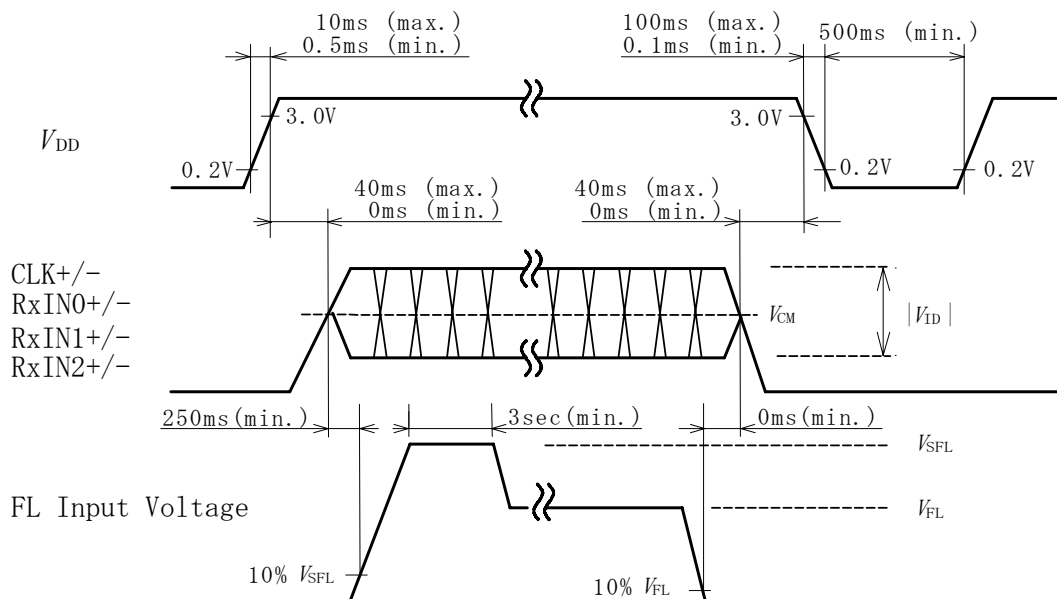

Note) When turn VDD on and turn it off, the form of voltage should be input with no ripple signal.

TIMING CHART

(1) Vertical Timing

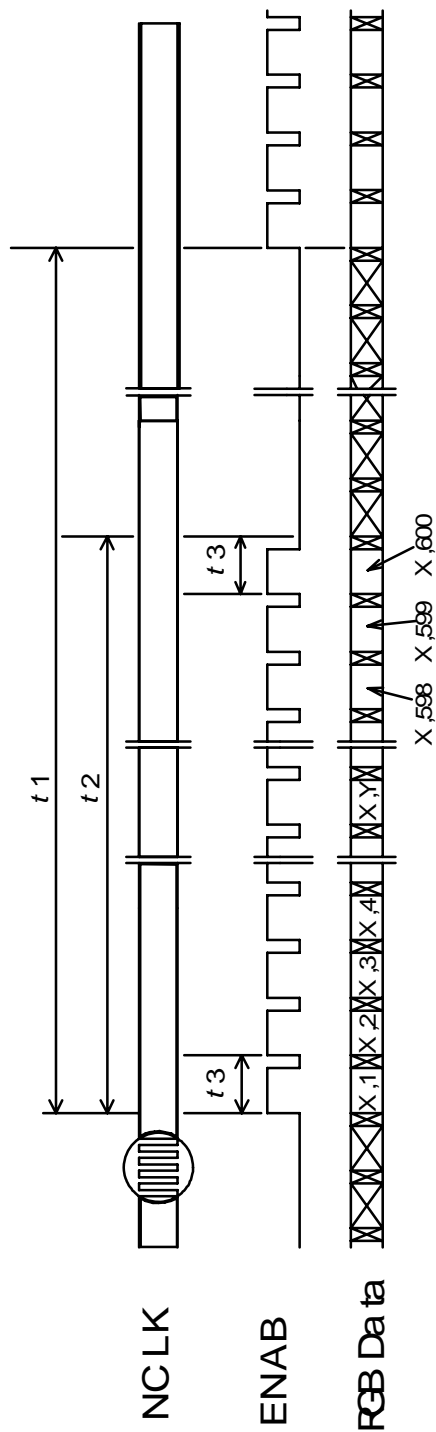

(2) Horizontal Timing

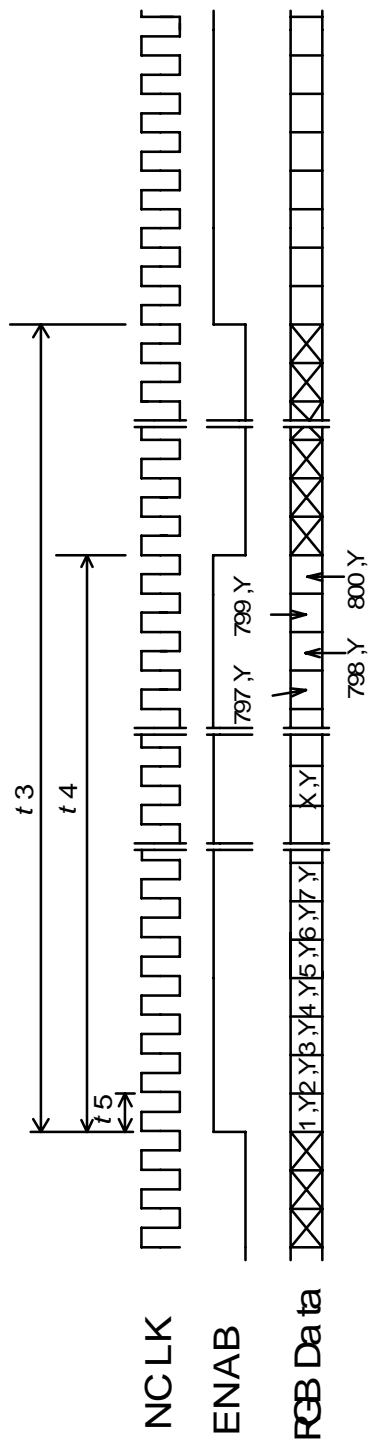

TIMING SPECIFICATION ^{1) 2) 3) 4) 5) 6)}

Item	Symbol	Min.	Typ.	Max.	Unit	Remarks
Frame Period	t_1	604 x t_3	628 x t_3 16.58	677 x t_3 17.86	---	ms
Vertical Display Term	t_2	600 x t_3	600 x t_3	600 x t_3	---	
One Line Scanning Time	t_3	944 x t_5 26.3	1056 x t_5 26.4	1064 x t_5 ---	---	μ s
Horizontal Display Term	t_4	800 x t_5	800 x t_5	800 x t_5	---	
Clock Period	t_5	24.7	25.0	27.8	ns	

Note 1) Refer to "TIMING CHART" and LVDS (THC63LVDF84A) specifications by THine Electronics, Inc.

Note 2) If ENAB is fixed to "H" or "L" level for certain period while NCLK is supplied, the panel displays black with some flicker.

Note 3) Don't fix NCLK to "H" or "L" level while the VDD is supplied.

If NCLK is fixed to "H" or "L" level for certain period while ENAB is supplied, the panel may be damaged.

When it holds on, DC voltage supplies to liquid crystal materials and it may cause damage to liquid crystal materials.

Note 4) Please adjust LCD operating signal timing and FL driving frequency, to optimize the display quality.

There is a possibility that flicker is observed by the interference of LCD operating signal timing and FL driving condition (especially driving frequency), even if the condition satisfies above timing specifications and recommended operating conditions shown on page 1.

Note 5) Do not make t_1 , t_2 and t_3 fluctuate.

If t_1 , t_2 and t_3 are fluctuate, the panel displays black.

Note 6) Keep constant the number of clock within one line scanning time and the number of scanning line within one frame period.

CONNECTOR PIN ASSIGNMENT FOR INTERFACE

CN1 INPUT SIGNAL

Connector : 20268-020E-03F / I-PEX CO., LTD.

Mating Connector : 20230-020B-F or 20230-T20-F or 20230-W20B-F / I-PEX CO.,LTD.

DF19G-20S-1C(Plug), DF19-2830SCFA(Crimp contact) / HIROSE ELECTRIC CO., LTD.

Terminal No.	Symbol	Function
1	V _{DD}	+3.3V POWER SUPPLY
2	V _{DD}	+3.3V POWER SUPPLY
3	GND* ¹	
4	GND* ¹	
5	RxIN0-	Negative LVDS differential data input (R0-R5, G0) * ³
6	RxIN0+	Positive LVDS differential data input (R0-R5, G0) * ³
7	GND* ¹	
8	RxIN1-	Negative LVDS differential data input (G1-G5, B0-B1) * ³
9	RxIN1+	Positive LVDS differential data input (G1-G5, B0-B1) * ³
10	GND* ¹	
11	RxIN2-	Negative LVDS differential data input (B2-B5, HS, VS, DE) * ³
12	RxIN2+	Positive LVDS differential data input (B2-B5, HS, VS, DE) * ³
13	GND* ¹	
14	CLK-	Clock Signal (-)
15	CLK+	Clock Signal (+)
16	GND* ¹	
17	REV	Display Reverse("L" level or Open;Normal, "H" level; Reverse)
18	GND* ¹	
19	NC* ²	Non Connection (open)
20	GND* ¹	

*1 Please connect GND pin to ground. Don't use it as no-connect nor connection with high impedance.

*2 Please connect NC pin to nothing. Don't connect it to ground nor to other signal input.

*3 Refer to next page.

CN2 CCFL POWER SOURCE

Connector : BHR-04VS-1/JAPAN SOLDERLESS TERMINAL MFG CO., LTD.

Mating Connector *⁴ : SM04(4.0)B-BHS-1-TB/JAPAN SOLDERLESS TERMINAL MFG CO., LTD.

Terminal No.	Symbol	Function
1	VFLH	CCFL POWER SUPPLY (HIGH VOLTAGE)
2	VFLH	CCFL POWER SUPPLY (HIGH VOLTAGE)
3	NC * ²	
4	VFLL	CCFL POWER SUPPLY (LOW VOLTAGE)

*4 Take away terminal No.3 of the mating connector. If does not take away, it may cause smoke burn of Electrical parts by high voltage.

CN3 TOUCH PANEL

FPC: 1.0mm pitch, Gold plating

Mating connector: FC1S004HA1 / JAE

Terminal No.	Symbol	Function
1	XR	Touch Panel XR Terminal
2	YU	Touch Panel YU Terminal
3	XL	Touch Panel XL Terminal
4	YD	Touch Panel YD Terminal

**RECOMMENDED TRANSMITTER (THC63LVDF63A, THC63LVDM63A by Thine Electronics, Inc.)
TO LTA084C272F INTERFACE ASSIGNMENT**

Case1: 6bit Transmitter

THC63LVDF63A, THC63LVDM63A				Output Signal Symbol	LTA084C272F Interface (CN1)	
Input Terminal No.		Input Signal (Graphics controller output signal)			Terminal	Symbol
Symbol	Terminal	Symbol	Function			
TA0	44	R0	Red Pixels Display Data (LSB)	TA- TA+	No.5 No.6	RxIN0- RxIN0+
TA1	45	R1	Red Pixels Display Data			
TA2	47	R2	Red Pixels Display Data			
TA3	48	R3	Red Pixels Display Data			
TA4	1	R4	Red Pixels Display Data			
TA5	3	R5	Red Pixels Display Data (MSB)			
TA6	4	G0	Green Pixels Display Data (LSB)			
TB0	6	G1	Green Pixels Display Data	TB- TB+	No.8 No.9	RxIN1- RxIN1+
TB1	7	G2	Green Pixels Display Data			
TB2	9	G3	Green Pixels Display Data			
TB3	10	G4	Green Pixels Display Data			
TB4	12	G5	Green Pixels Display Data (MSB)			
TB5	13	B0	Blue Pixels Display Data (LSB)			
TB6	15	B1	Blue Pixels Display Data			
TC0	16	B2	Blue Pixels Display Data	TC- TC+	No.11 No.12	RxIN2- RxIN2+
TC1	18	B3	Blue Pixels Display Data			
TC2	19	B4	Blue Pixels Display Data			
TC3	20	B5	Blue Pixels Display Data (MSB)			
TC4	22	HSYNC	H-Sync			
TC5	23	VSYNC	V-Sync			
TC6	25	DE	Compound Synchronization Signal			
CLK IN	26	NCLK	Data Sampling Clock	TCLK- TCLK+	No.14 No.15	CLK- CLK+

Note 1) Please connect NC pin to nothing. Don't connect it to ground nor to other signal input.

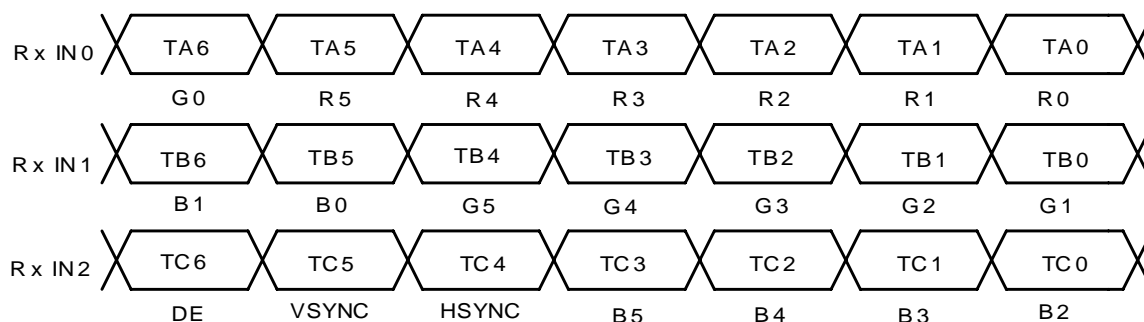

**RECOMMENDED TRANSMITTER (THC63LVDM83D, THC63LVDM83R by THine Electronics, Inc.)
TO LTA084C272F INTERFACE ASSIGNMENT**

Case2: 8bit Transmitter

THC63LVDM83D, THC63LVDM83R				LTA084C272F Interface (CN1)		
Input Terminal No.		Input Signal (Graphics controller output signal)		Output Signal Symbol		
Symbol	Terminal	Symbol	Function		Terminal	Symbol
TA0	51	R0	Red Pixels Display Data (LSB)	TA- TA+	No.5 No.6	RxIN0- RxIN0+
TA1	52	R1	Red Pixels Display Data			
TA2	54	R2	Red Pixels Display Data			
TA3	55	R3	Red Pixels Display Data			
TA4	56	R4	Red Pixels Display Data			
TA5	3	R5	Red Pixels Display Data (MSB)			
TA6	4	G0	Green Pixels Display Data (LSB)			
TB0	6	G1	Green Pixels Display Data	TB- TB+	No.8 No.9	RxIN1- RxIN1+
TB1	7	G2	Green Pixels Display Data			
TB2	11	G3	Green Pixels Display Data			
TB3	12	G4	Green Pixels Display Data			
TB4	14	G5	Green Pixels Display Data (MSB)			
TB5	15	B0	Blue Pixels Display Data (LSB)			
TB6	19	B1	Blue Pixels Display Data			
TC0	20	B2	Blue Pixels Display Data	TC- TC+	No.11 No.12	RxIN2- RxIN2+
TC1	22	B3	Blue Pixels Display Data			
TC2	23	B4	Blue Pixels Display Data			
TC3	24	B5	Blue Pixels Display Data (MSB)			
TC4	27	HSYNC	H-Sync			
TC5	28	VSYNC	V-Sync			
TC6	30	DE	Compound Synchronization Signal			
TD0	50	NC ^{*1}	Non Connection (open)	TD- TD+		
TD1	2	NC ^{*1}	Non Connection (open)			
TD2	8	NC ^{*1}	Non Connection (open)			
TD3	10	NC ^{*1}	Non Connection (open)			
TD4	16	NC ^{*1}	Non Connection (open)			
TD5	18	NC ^{*1}	Non Connection (open)			
TD6	25	NC ^{*1}	Non Connection (open)			
CLK IN	31	NCLK	Data Sampling Clock	TCLK- TCLK+	No.14 No.15	CLK- CLK+

Note 1) Please connect NC pin to nothing. Don't connect it to ground nor to other signal input.

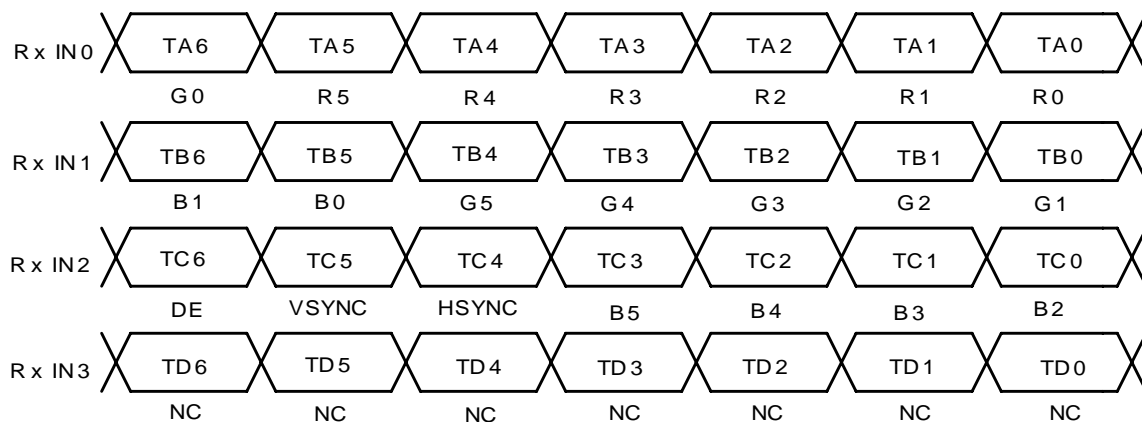

256k (k=1024) COLORS COMBINATION TABLE

	Display	R5 R4 R3 R2 R1 R0	G5 G4 G3 G2 G1 G0	B5 B4 B3 B2 B1 B0	Gray Scale Level
Basic Color	Black	L L L L L L L	L L L L L L L	L L L L L L L	---
	Blue	L L L L L L L	L L L L L L L	H H H H H H H	---
	Green	L L L L L L L	H H H H H H H	L L L L L L L	---
	Light Blue	L L L L L L L	H H H H H H H	H H H H H H H	---
	Red	H H H H H H H	L L L L L L L	L L L L L L L	---
	Purple	H H H H H H H	L L L L L L L	H H H H H H H	---
	Yellow	H H H H H H H	H H H H H H H	L L L L L L L	---
	White	H H H H H H H	H H H H H H H	H H H H H H H	---
Gray Scale of Red	Black	L L L L L L L	L L L L L L L	L L L L L L L	L 0
	Dark ↑ ↓ Light	L L L L L L H	L L L L L L L	L L L L L L L	L 1
		L L L L L H L	L L L L L L L	L L L L L L L	L 2
		: : :	: : :	: : :	L3... L60
		H H H H L H L	L L L L L L L	L L L L L L L	L61
	H H H H H L L	L L L L L L L	L L L L L L L	L62	
	Red	H H H H H H H	L L L L L L L	L L L L L L L	Red L63
	Gray Scale of Green	Black	L L L L L L L	L L L L L L L	L L L L L L L
Dark ↑ ↓ Light		L L L L L L L	L L L L L L H	L L L L L L L	L 1
		L L L L L L L	L L L L L H L	L L L L L L L	L 2
		: : :	: : :	: : :	L3... L60
		L L L L L L L	H H H H L H L	L L L L L L L	L61
L L L L L L L		H H H H H L L	L L L L L L L	L62	
Green		L L L L L L L	H H H H H H H	L L L L L L L	Green L63
Gray Scale of Blue		Black	L L L L L L L	L L L L L L L	L L L L L L L
	Dark ↑ ↓ Light	L L L L L L L	L L L L L L L	L L L L L H L	L 1
		L L L L L L L	L L L L L L L	L L L L H L L	L 2
		: : :	: : :	: : :	L3... L60
		L L L L L L L	L L L L L L L	H H H H L H L	L61
	L L L L L L L	L L L L L L L	H H H H H L L	L62	
	Blue	L L L L L L L	L L L L L L L	H H H H H H H	Blue L63
	Gray Scale of White & Black	Black	L L L L L L L	L L L L L L L	L L L L L L L
Dark ↑ ↓ Light		L L L L L L H	L L L L L L H	L L L L L L H	L 1
		L L L L L H L	L L L L L H L	L L L L L H L	L 2
		: : :	: : :	: : :	L3... L60
		H H H H L H L	H H H H L H L	H H H H L H L	L61
H H H H H L L		H H H H H L L	H H H H H L L	L62	
White		H H H H H H H	H H H H H H H	H H H H H H H	White L63

**FOR SAFETY**

LCD module is generally designed with precise parts to achieve light weighted thin mechanical dimensions. In using our Modules, make certain that you fully understand and put into practice the warnings and safety precautions detailed in Engineering Information No.EE-N001,"CAUTIONS AND INSTRUCTIONS FOR TOSHIBA LCD MODULES". Refer to individual specifications and TECHNICAL DATA sheets (hereinafter called "TD") for more detailed technical information.

1) SPECIAL PURPOSES

A) Toshiba Mobile Display Co., Ltd 's Standard LCD Modules have not been customized for operation in extreme environments or for use in applications where performance failures could be life-threatening or otherwise catastrophic.

B) Since Toshiba Mobile Display Co., Ltd 's Standard LCD Modules have not been designed for operation in extreme environments, they must never be used in devices that will be exposed to abnormally high levels of vibration or shock which exceed Toshiba Mobile Display Co., Ltd 's published specification limits.

C) In addition, since Toshiba Mobile Display Co., Ltd Standard LCD Modules have not been designed for use in applications where performance failures could be life-threatening or catastrophic, they must never be installed in aircraft navigation control systems (such as, but not limited to Traffic Collision Avoidance System and Air Traffic Indicator), in military defense or weapons systems, in critical industrial process-control systems (e.g., those involved in the production of nuclear energy), or in critical medical device or patient life-support systems.

2) DISASSEMBLING OR MODIFICATION

DO NOT DISASSEMBLE OR MODIFY the module. It may damage sensitive parts inside LCD module, and may cause scratches or dust on the display.

Toshiba Mobile Display Co., Ltd does not warrant the module, if customer disassembled or modified it.

3) BREAKAGE OF LCD PANEL

DO NOT INGEST liquid crystal material, DO NOT INHALE this material, and DO NOT CONTACT the material with skin, if LCD panel is broken and liquid crystal material spills out.

If liquid crystal material comes into mouth or eyes, rinse mouth or eyes out with water immediately.

If this material contact with skin or cloths, wash it off immediately with alcohol and rinse thoroughly with water.

4) GLASS OF LCD PANEL

BE CAREFUL WITH CHIPS OF GLASS that may cause injuring fingers or skin, when the glass is broken.

5) ELECTRIC SHOCK

DISCONNECT POWER SUPPLY before handling LCD module.

DO NOT TOUCH the parts inside LCD module and the fluorescent lamp's connector or cables in order to prevent electric shock, because high voltage is supplied to these parts from the inverter unit while power supply is turned on.

6) ABSOLUTE MAXIMUM RATINGS AND POWER PROTECTION CIRCUIT

DO NOT EXCEED the absolute maximum rating values under the worst probable conditions caused by the supply voltage variation, input voltage variation, variation in parts' constants, environmental temperature, etc., otherwise LCD module may be damaged.

Employ protection circuit for power supply, whenever the specification or TD specifies it.

Suitable protection circuit should be applied for each system design.

7) RECOMMENDED OPERATION CONDITIONS

The performance and quality of the LCD panel are warranted only when the LCD panel is used within "the recommended operation conditions". Toshiba Mobile Display Co., Ltd. never warrants the performance and quality of the LCD panel when you use the LCD panel over "the recommended operation conditions", although within "the absolute maximum rating".

To use the LCD panel over "the recommended operation conditions" may have bad influence on the characteristics and reliability of the LCD panel and may shorten the life of the LCD panel.

Therefore, when designing the whole set, not to be over "the recommended operation conditions", you should fully take care of supply voltage change, characteristic of connection parts, surge of input-and-output line, and surrounding temperature.

8) DISPOSAL

When dispose LCD module, obey to the applicable environmental regulations.

单击下面可查看定价，库存，交付和生命周期等信息

[>>Toshiba\(东芝\)](#)