

TOSHIBA Bi-CMOS Integrated Circuit Silicon Monolithic

TB67B054FTG

Sine-wave PWM Drive Three-phase Full Wave Brushless Motor Controller

The TB67B054FTG is developed for three-phase brushless DC motors of motor fans.

Features

- Sine-wave PWM control
- Triangular-wave generator (carrier frequency = $f_{osc}/252$ Hz)
- Lead angle control (0° to 58° in 32 separate steps)
External setting or automatic internal control
- Current-limiting input pin
- Internal voltage regulator circuit ($V_{refout} = 5$ V (typ.), 30 mA (max))
- Operating supply voltage range: $V_{CC} = 6$ V to 16.5 V

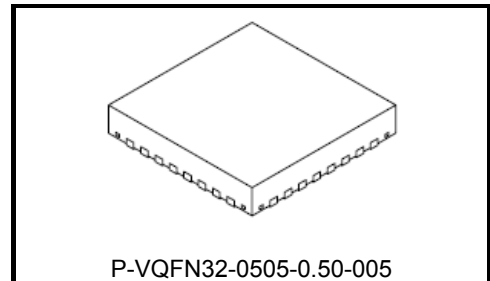

Weight: 0.07 g (typ.)

Block diagram

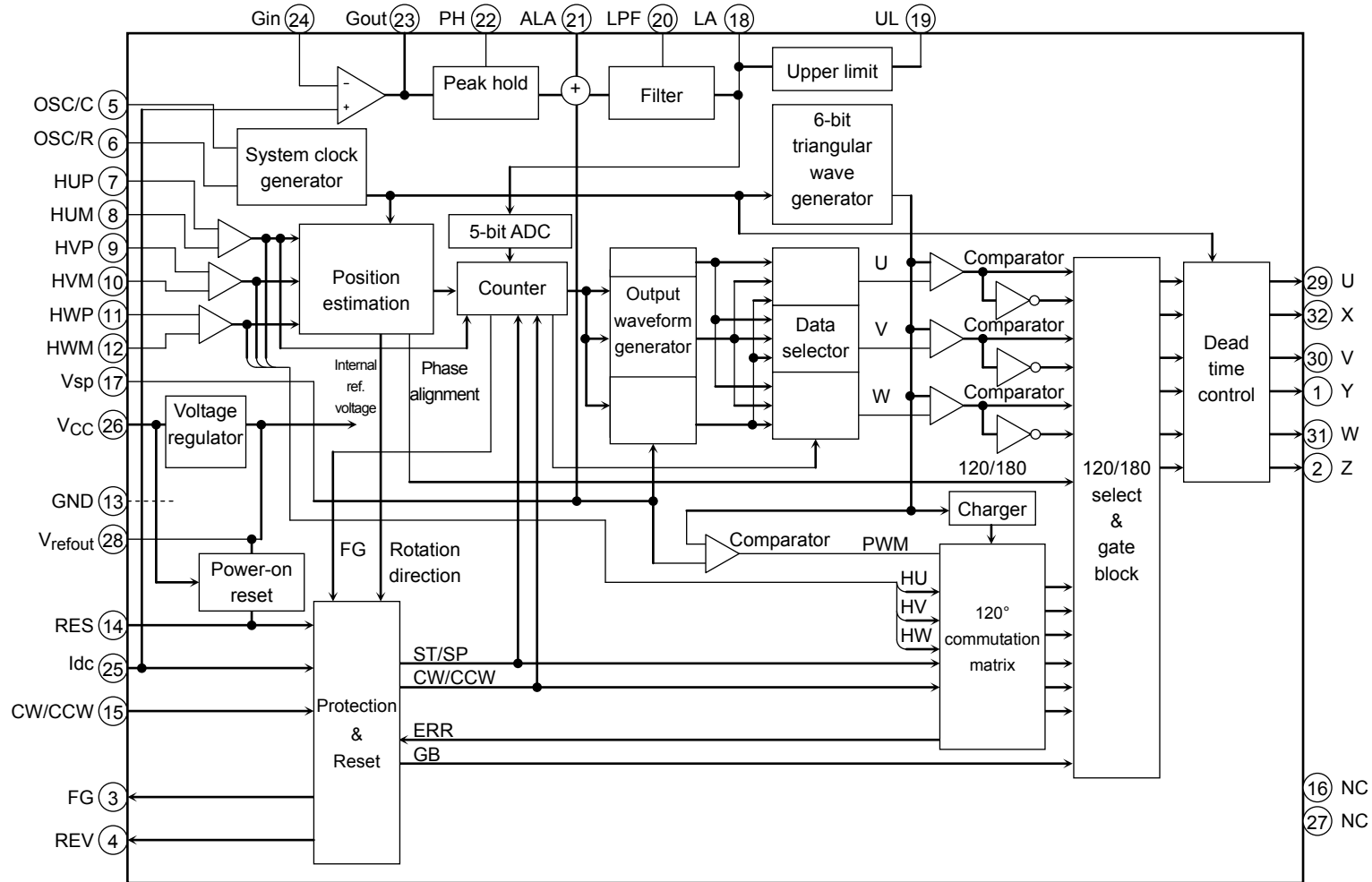

Some of the functional blocks, circuits, or constants in the block diagram may be omitted or simplified for explanatory purposes.

Pin assignment

<Top View>

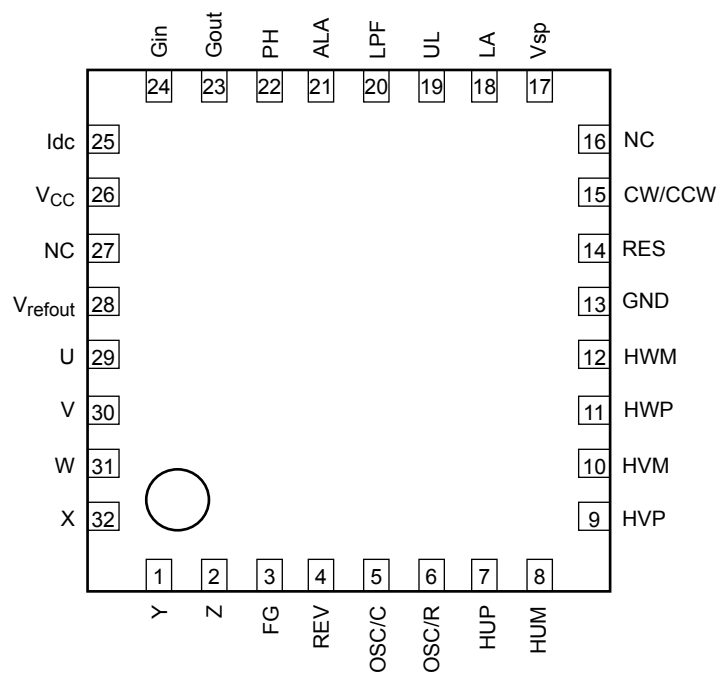

Pin description

| Pin No. | Symbol | Function | Description |
|---------|---------------------|--|---|
| 5 | OSC/C | Oscillator capacitor | CR oscillation |
| 6 | OSC/R | Oscillator resistor | |
| 7 | HUP | Hall signal input, U | Gate block protection is activated when hall signals of U, V, and W phases are all "H" or "L". These inputs have internal digital filters (≈ 500 ns) |
| 8 | HUM | | |
| 9 | HVP | Hall signal input, V | |
| 10 | HVM | | |
| 11 | HWP | Hall signal input, W | |
| 12 | HWM | | |
| 13 | GND | Ground | |
| 14 | RES | Reset input | L: Motor operates, H: Motor stops (commutation output signals are forced low.) Built in pulldown resistor |
| 15 | CW/CCW | Clockwise/counterclockwise rotation | L: Clockwise rotation, H: Counterclockwise rotation Built-in pullup resistor |
| 16 | NC | NC pin | No connection |
| 17 | V _{sp} | Voltage command input | Built-in pulldown resistor |
| 18 | LA | Lead angle control input | LA input allows the lead angle to be adjusted between 0° and 58° in 32 separate steps. |
| 19 | UL | Upper limit for LA | UL input determines the upper limit for the lead angle (UL = 0 V to 5.0 V). |
| 20 | LPF | RC low-pass filter capacitor | A capacitor for the RC low-pass filter is connected to this pin. (Built-in a 100 k Ω resistor) |
| 21 | ALA | Auto lead angle mode select input | Built-in pulldown resistor L or open: Feeds back I _{dc} and V _{sp} to generate the modulated waves per electrical angle of 60°. H: Feeds back I _{dc} to generate the modulated waves per electrical angle of 360°. |
| 22 | PH | Peak hold | A peak-hold capacitor and a discharge resistor are connected to this pin. |
| 23 | Gout | Gain setting | The Gin and Gout pins are used to amplify the I _{dc} level so that the lead angle will be optimal. |
| 24 | Gin | | |
| 25 | I _{dc} | Current limit control input | The DC-link current is applied to the I _{dc} input. The reference voltage is 0.5 V. The I _{dc} input has an internal RC filter (with a time constant of 1 μ s) and a digital filter (with a time constant of 1 μ s). |
| 26 | V _{CC} | Power supply | V _{CC} = 6 V to 16.5 V |
| 27 | NC | NC pin | Non connection |
| 28 | V _{refout} | Reference voltage output | 5 V (typ.), 30 mA (max) A capacitor for oscillation prevention is connected to the V _{refout} output. |
| 29 | U | Commutation signal output U, (U high-side) | High-active |
| 30 | V | Commutation signal output V, (V high-side) | |
| 31 | W | Commutation signal output W, (W high-side) | |
| 32 | X | Commutation signal output X, (U low-side) | |
| 1 | Y | Commutation signal output Y, (V low-side) | |
| 2 | Z | Commutation signal output Z, (W low-side) | |
| 3 | FG | FG signal output | |
| 4 | REV | Reverse rotation detection signal | The REV output is used to detect an occurrence of reverse rotation. |

Input/output equivalent circuits

Equivalent circuit diagrams may be partially omitted or simplified for explanatory purposes.

| Pin | Symbol | Input/output signal | Internal circuit |
|---|--|--|------------------|
| Hall signal input, U Hall signal input, V Hall signal input, W | HUP HUM HVP HVM HWP HWM | Analog Hysteresis: ± 7.5 mV (typ.) | |
| Clockwise/counterclockwise rotation L: forward (CW) H: reverse (CCW) | CW/CCW | Digital L: 0.8 V (max) H: $V_{refout} - 1$ V (min) | |
| Reset input L: Motor operation H: Motor stop (Reset) | RES | Digital L: 0.8 V (max) H: $V_{refout} - 1$ V (min) | |
| Auto lead angle mode select L or open: I_{dc} and $V_{sp} / 60^\circ$ H: $I_{dc} / 360^\circ$ | ALA | Digital L: 0.8 V (max) H: $V_{refout} - 1$ V (min) | |
| Voltage command signal 1.0 V < V_{sp} ≤ 2.1 V Refresh operation (The X, Y and Z pins have a conduction duty cycle of 8 %.) | V_{sp} | Analog V_{sp} voltage range: 0 V to 10 V When 5.7 V ≤ V_{sp} ≤ 7.3 V, the PWM duty cycle is fixed at 92% (typ.). When 8.2 V ≤ V_{sp} ≤ 10 V, the TB67B054FTG is put in test mode. | |

| Pin | Symbol | Input/output signal | Internal circuit |
|--|-------------|--|------------------|
| Lead angle control input 0 V: 0° 5 V: 58° (5-bit ADC) | LA | To fix the lead angle externally, UL and V_{refout} should be connected together. The lead angle is linearly determined according to the voltage applied to the LA input. LA voltage range: 0 to 5.0 V (V_{refout}) If $LA > V_{refout}$, the commutation occurs with the maximum lead angle of 58°. When configured for auto lead angle control, the LA input should be left open. At this time, the LA input can be used to check the lead angle in real time. | |
| Gain setting (Lead angle control circuitry) | Gin Gout | Non-inverting amplifier 25 dB max Gout: Output voltage L: GND H: $V_{CC} - 1.7 V$ | |
| Peak hold (Lead angle control circuitry) | PH | A peak-hold capacitor and a discharge resistor are connected to the PH pin. Recommended R/C values: 100 kΩ/0.1 μF | |
| Low-pass filter (Lead angle control circuitry) | LPF | A capacitor for the RC low-pass filter is connected to this pin. Built-in a 100 kΩ (typ.) resistor Recommended C value: 0.1 μF | |
| Upper limit for LA | UL | If the voltage applied to the LA input exceeds the upper limit set by this input, it is clipped to limit the lead angle. UL = 0 to 5.0 V | |

| Pin | Symbol | Input/output signal | Internal circuit |
|--|----------------------------|---|------------------|
| Current limit control input | Idc | <p>Analog filter time constant: 1 μs (typ.)</p> <p>Digital filter time constant: 1 μs (typ.)</p> <p>Gate block protection is activated when the Idc voltage exceeds 0.5 V. (It is disabled after every carrier cycle.)</p> <p>If Idc is left unconnected, all the commutation outputs are disabled.</p> | |
| Reference voltage output | Vrefout | 5 \pm 0.5 V (30 mA max) | |
| Reverse rotation detection signal | REV | Digital Push-pull output (\pm 1 mA max) | |
| FG signal output | FG | Digital Push-pull output (\pm 1 mA max) The FG output gives two pulses per electrical revolution. | |
| Commutation signal output, U Commutation signal output, V Commutation signal output, W Commutation signal output, X Commutation signal output, Y Commutation signal output, Z | U V W X Y Z | Digital Push-pull outputs (\pm 2 mA max) L: 0.78 V (max) H: Vrefout - 0.78 V (min) | |

Absolute maximum ratings (Ta = 25°C)

| Characteristics | Symbol | Rating | Unit |
|------------------------------------|---------------------|--|------|
| Supply voltage | V _{CC} | 18 | V |
| Input voltage | V _{IN (1)} | -0.3 to V _{CC} (Note 1) | V |
| | V _{IN (2)} | -0.3 to V _{refout} + 0.3 (Note 2) | |
| Commutation output current | I _{OUT} | 2 | mA |
| V _{refout} output current | I _{refout} | 30 (Note 3) | mA |
| Power dissipation | P _D | 4.1 (Note 4) | W |
| Operating temperature | T _{opr} | -30 to 115 (Note 5) | °C |

Note: The absolute maximum ratings of a semiconductor device are a set of ratings that must not be exceeded, even for a moment. Do not exceed any of these absolute maximum ratings. Exceeding the absolute maximum rating (s) may cause the device breakdown, damage or deterioration, and may result injury by explosion or combustion. Please use the IC within the specified operating ranges.

Note 1: V_{IN (1)} pin: V_{sp}, LA, and UL

Note 2: V_{IN (2)} pins: HUP, HVP, HWP, HUM, HVM, HWM CW/CCW, RES, I_{dc}, ALA, and Gin

Note 3: Since the V_{refout} pin delivers a maximum output current of 30 mA, care should be exercised to the output impedance.

Note 4: When mounted on a board (4 layers, FR4, 76.2 mm×114.3 mm×1.6 mm), R_{th (j-a)} = 29.9°C/W

Note 5: The operating temperature range is determined by the 'P_D – T_a characteristics'.

Operating ranges (Ta = 25°C)

| Characteristics | Symbol | Min | Typ. | Max | Unit |
|-----------------------|------------------|-----|------|------|------|
| Supply voltage | V _{CC} | 6 | 15 | 16.5 | V |
| Oscillation frequency | f _{osc} | 3 | 4.5 | 6 | MHz |

Power dissipation (for reference only)

When mounted on a board (4 layers, FR4, 76.2 mm × 114.3 mm × 1.6 mm), R_{th (j-a)} = 29.9°C/W

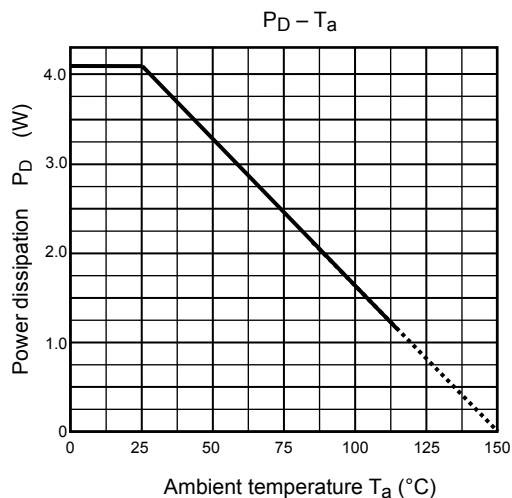

Electrical characteristics (Ta = 25°C, VCC = 15 V)

| Characteristics | | Symbol | Test Condition | Min | Typ. | Max | Unit | |
|---|---------------------------|------------------------|---|---|-----------------------------|------|---------------------|---|
| Supply current | | I _{CC} | V _{refout} = OPEN | — | 5 | 8 | mA | |
| Input current | | I _{IN (1)-1} | V _{IN} = 5 V LA | — | 25 | 50 | μA | |
| | | I _{IN (1)-2} | V _{IN} = 5 V V _{sp} | — | 35 | 70 | | |
| | | I _{IN (2)-1} | V _{IN} = 5 V ALA, RES | — | 50 | 100 | | |
| | | I _{IN (2)-2} | V _{IN} = 0 V CW/CCW | -100 | -50 | — | | |
| Input voltage | | V _{IN} | H | CW/CCW, RES, ALA | V _{refout} -1 | — | V _{refout} | V |
| | | | L | | — | — | 0.8 | |
| | | V _{sp} | T | Forced 120° commutation, conduction duty cycle = 92% -3.8 μs (typ.) | 8.2 | — | 10 | |
| | | | H | PWM duty 92% | 5.1 | 5.4 | 5.7 | |
| | | | M | Refresh → Motor startup | 1.8 | 2.1 | 2.4 | |
| | | | L | Commutation off → Refresh | 0.7 | 1.0 | 1.3 | |
| Hall sensor inputs | Input sensitivity | V _S | Differential inputs | 100 | — | — | mVpp | |
| | Common-mode input voltage | V _W | — | 1.5 | — | 3.5 | V | |
| | Input hysteresis | V _{H (1)} | (Note) | ±5.5 | ±7.5 | ±9.5 | mV | |
| Input delay time | | T _{DT} | Hall inputs (f _{osc} = 4.5 MHz) | — | 1.0 | — | μs | |
| | | T _{DC} | Idc (f _{osc} = 4.5 MHz) | — | 2.5 | — | | |
| Output voltage | | V _{OUT (H)-1} | I _{OUT} = 2 mA U, V, W, X, Y, Z | V _{refout} -0.78 | V _{refout} -0.3 | — | V | |
| | | V _{OUT (L)-1} | I _{OUT} = -2 mA U, V, W, X, Y, Z | — | 0.3 | 0.78 | | |
| | | V _{REV (H)} | I _{OUT} = 1 mA REV | V _{refout} -1.0 | V _{refout} -0.2 | — | | |
| | | V _{REV (L)} | I _{OUT} = -1 mA REV | — | 0.2 | 1.0 | | |
| | | V _{FG (H)} | I _{OUT} = 1 mA FG | V _{refout} -1.0 | V _{refout} -0.2 | — | | |
| | | V _{FG (L)} | I _{OUT} = -1 mA FG | — | 0.2 | 1.0 | | |
| | | V _{refout} | I _{OUT} = 30 mA V _{refout} | 4.5 | 5.0 | 5.5 | | |
| Output leakage current | | I _{L (H)} | V _{OUT} = 0 V U, V, W, X, Y, Z | — | 0 | 10 | μA | |
| | | I _{L (L)} | V _{OUT} = V _{refout} U, V, W, X, Y, Z | — | 0 | 10 | | |
| Dead time (cross conduction protection) | | T _{OFF} | (f _{osc} = 4.5 MHz), I _{OUT} = ± 2 mA | 1.7 | 2.0 | 2.3 | μs | |
| Current sensing | | V _{DC} | Idc | 0.46 | 0.5 | 0.54 | V | |
| LA gain setting amp | | AMP _{OUT} | G _{in} , G _{out} 100 kΩ/10 kΩ Idc = 0.2 V, I _{OUT} = 1 mA | 2.0 | 2.2 | 2.4 | V | |
| | | AMP _{OFS} | G _{in} , G _{out} 100 kΩ/10 kΩ, Idc = 0.2 V | — | 5 | — | mV | |
| LA limit setting error | | ΔU | UL = 2.0 V | -20 | — | 20 | mV | |
| LA peak hold output voltage | | PHOUT | G _{in} , G _{out} 100 kΩ/10 kΩ Idc = 0.2 V, I _{OUT} = 5 mA | 2.0 | 2.2 | 2.4 | V | |
| Lead angle correction | | T _{LA (0)} | LA = 0 V or Open, Hall inputs = 100 Hz | — | 0 | — | ° | |
| | | T _{LA (2.5)} | LA = 2.5 V, Hall inputs = 100 Hz | 26 | 30 | 33 | | |
| | | T _{LA (5)} | LA = 5 V, Hall inputs = 100 Hz | 52 | 57 | 60 | | |
| V _{CC} monitor | | V _{CC (H)} | Output turn-on threshold | 4.2 | 4.5 | 4.8 | V | |
| | | V _{CC (L)} | Output turn-off threshold | 3.7 | 4.0 | 4.3 | | |
| | | V _H | Input hysteresis width | — | 0.5 | — | | |

| Characteristics | Symbol | Test Condition | Min | Typ. | Max | Unit |
|--|----------------|---|------|------|------|------|
| PWM oscillation frequency (carrier frequency) | F_C (20) | OSC/C = 330 pF, OSC/R = 9.1 k Ω | 18 | 20 | 22 | kHz |
| | F_C (18) | OSC/C = 330 pF, OSC/R = 10 k Ω | 16.2 | 18 | 19.8 | |
| Maximum conduction duty cycle | T_{ON} (max) | OSC/C = 330 pF, OSC/R = 10 k Ω $V_{sp} = 5.7$ V | 89 | 92 | 95 | % |

Note: No shipping inspection.

Functional description

1. Basic operation

During startup, the motor is driven by square-wave commutation signals that are generated according to the hall signals. When the hall signals indicate a rotational speed (f) of 5.7 Hz or more, the TB67B054FTG estimates the rotor positions from the hall signals and modulate them. The TB67B054FTG then generates sine-wave by comparing the modulated signals against a triangular waveform.

0 (startup) $\leq f < 5.7$ Hz : Square-wave drive (120° commutation); $f = f_{osc} / (2^{12} \times 32 \times 6)$

5.7 Hz $\leq f$: Sine-wave PWM drive (180° commutation); f will be approximately 5.7 Hz when $f_{osc} = 4.5$ MHz

2. Voltage command (V_{sp}) signal and bootstrap voltage regulation

- (1) When $V_{sp} \leq 1.0$ V :
The commutation signal outputs are disabled (i.e., gate protection is activated).
- (2) When 1.0 V $< V_{sp} \leq 2.1$ V :
The low-side transistors are turned on at a regular (PWM carrier) frequency. (The conduction duty cycle is approx. 8 %.)
- (3) When 2.1 V $< V_{sp} \leq 7.3$ V :
During sine-wave PWM drive, the commutation signals directly appear externally. During square-wave drive, the low-side transistors are forced on at a regular (PWM carrier) frequency. (The conduction duty cycle is approx. 8 %.)
- (4) When 8.2 V $\leq V_{sp} \leq 10$ V (test mode) :
The TB67B054FTG is forced into square-wave drive mode. The drive mode switches from sine-wave PWM to square-wave drive at a V_{sp} of 7.9 V (typ.). The conduction duty cycle during square-wave drive is calculated as PWM carrier period \times 92% – 3.8 μ s (typ.)

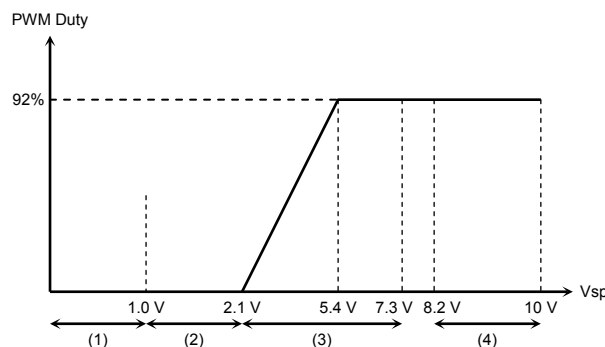

3. Dead time insertion (cross conduction protection)

To prevent a short-circuit between external low-side and high-side power devices during sine-wave PWM drive, a dead time is digitally inserted between the turn-on of one side and the turn-off of the other side. (The dead time is also implemented at the full duty cycle during square-wave drive.)

$T_{OFF} = 9/f_{osc}$
 $T_{OFF} \approx 2.0$ μ s when $f_{osc} = 4.5$ MHz,
 where f_{osc} is the reference clock
 frequency (CR oscillator frequency).

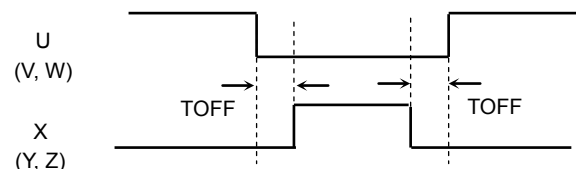

4. Lead angle control

The lead angle can be adjusted between 0° and 58° in 32 separate steps according to the induced voltage level on the LA input, which works with 0 to 5 V.

0 V = 0°

5 V = 58° (A lead angle of 58° is assumed when the LA voltage exceeds 5 V.)

5. PWM carrier frequency

The triangular waveform generator provides a carrier frequency of $f_{osc}/252$ necessary for PWM generation. (The triangular wave is also used to force the switch-on of low-side transistors during square-wave drive.)

Carrier frequency = $f_{osc}/252$ (Hz), where f_{osc} = reference clock (CR oscillator) frequency

6. Reverse rotation signal

The rotational direction of the motor is detected every 360 electrical degrees.

When REV pin is L level, the operation moves to the 180° commutation mode (with Hall signal inputs ≥ 5.7 Hz)

| CW/CCW pin | Actual motor rotation direction | REV pin |
|------------|---------------------------------|---------|
| L (CW) | CW (forward) | L |
| | CCW (reverse) | H |
| H (CCW) | CW (forward) | H |
| | CCW (reverse) | L |

7. Rotation frequency pulse output

Rotational pulses (2 pulses per electrical revolution) are outputted from FG pin.

When the frequency of the hall signal input is 5.7 Hz (when f_{osc} is 4.5 MHz) or more, 2 pulses are outputted per one cycle of the hall signal. Moreover, when the frequency of the hall signal input is less than 5.7 Hz, L level is outputted.

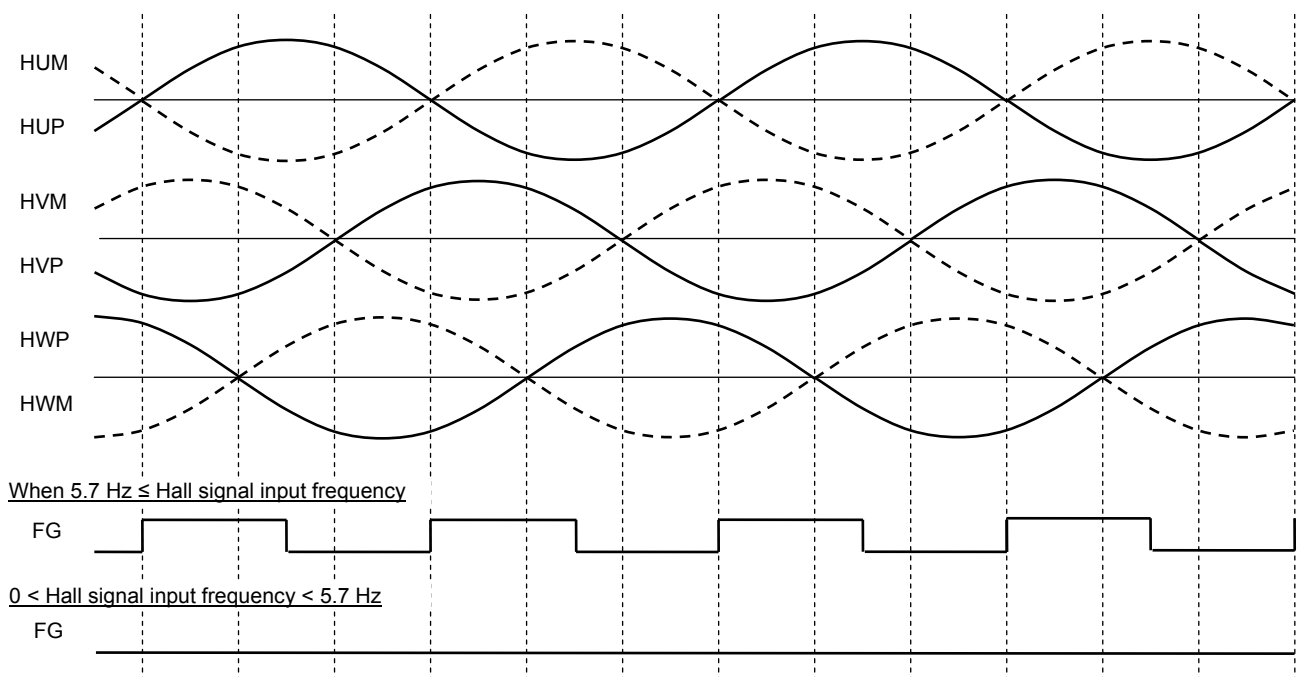

8. Protection-related input pins

(1) Overcurrent protection (Idc pin)

If the voltage of the DC-link current exceeds the internal reference voltage, the commutation signals are forced L. Overcurrent protection is disabled after every carrier cycle.

Reference voltage = 0.5 V (typ.)

(2) Gate block protection (RES pin)

When the RES input is H, the commutation outputs are disabled. When the RES input is then set L or open, the commutation outputs are re-enabled.

Any irregular conditions of the motor should be detected by external hardware; such indications should be presented to the RES input.

| RES pin | Commutation output signals (U, V, W, X, Y, Z) |
|-----------|--|
| H | L |
| L or open | Motor can be driven |

(When RES = H, charging of the bootstrap capacitor stops. Also when the operation re-enable, charging of the bootstrap capacitor stops.)

(3) Internal protection

- Abnormal hall signal protection

When the hall signal inputs (UVW) are all H or all L, the commutation outputs are forced off (i.e., set L). When these inputs are then set to any other combination, the commutation outputs are re-enabled. (The all-H and all-L conditions are internal hall amplifier outputs.)

- Under voltage lockout (VCC monitor)

While the power supply voltage is outside the rated range during power-on or power-off, the commutation outputs are set to the high-impedance state to prevent external power devices from damage due to short-circuits.

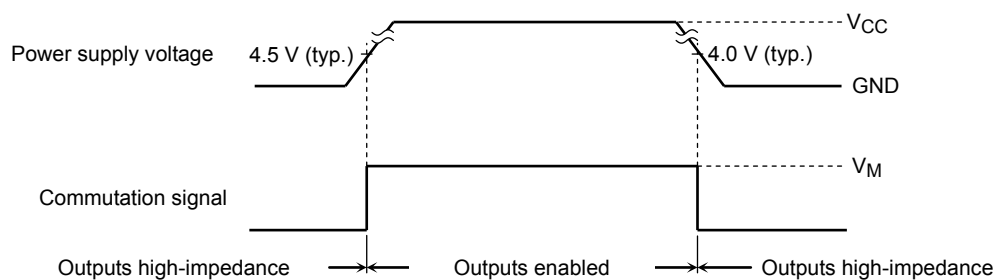

Operation flow

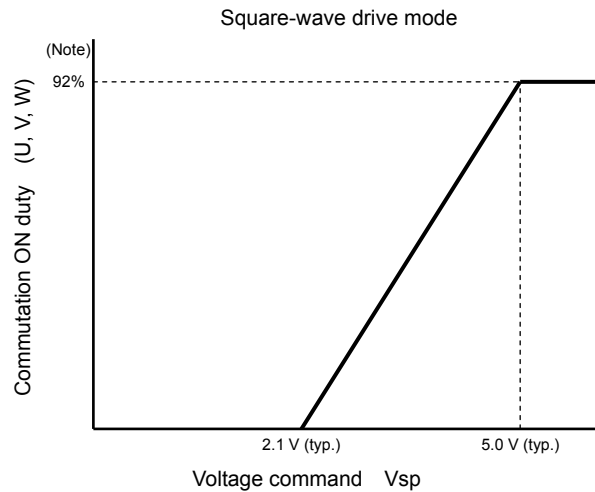
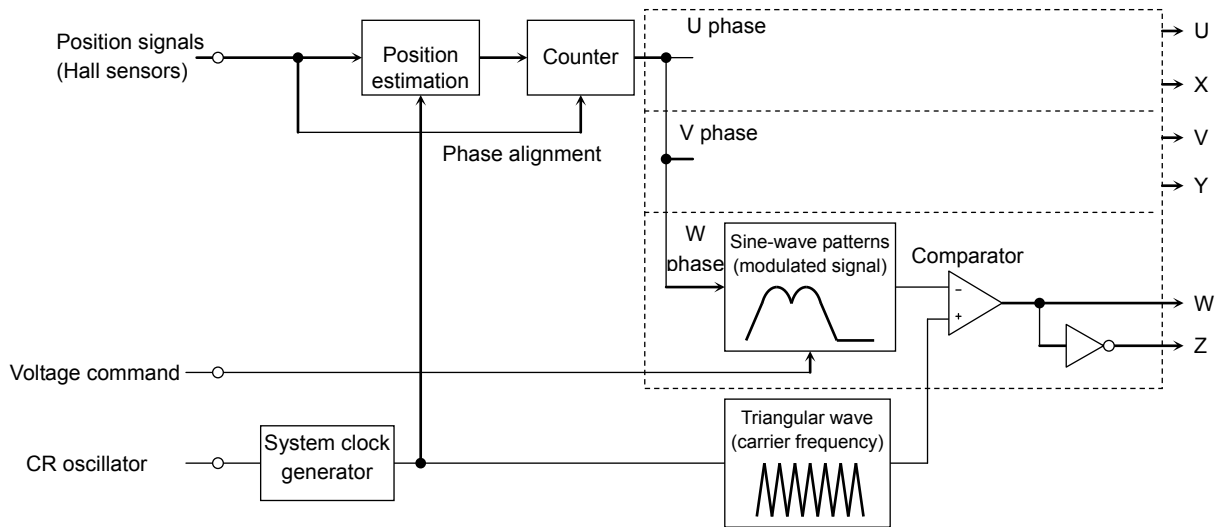

Note: The conduction time is reduced by the dead period. (carrier cycle \times 92% - $T_d \times 2$)

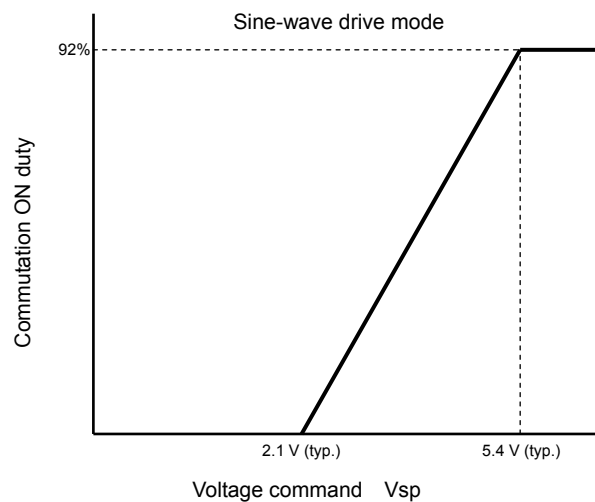

Timing of modulated signals

Reset timing for modulation can be selected by setting ALA pin.

Moreover, the auto lead angle mode can be also selected by ALA pin configuration.

| ALA | Modulated signal generation | Auto lead angle mode |
|-----|---|----------------------|
| H | Modulated for each 360 electrical degrees | Feedback Idc |
| L | Modulated for each 60 electrical degrees | Feedback Idc and Vsp |

Modulated when ALA= H

The hall signals from Hall sensors are modulated, and the modulated signals are then compared against a triangular waveform to generate a sinusoidal PWM waveform.

The counter measures the period from a given falling edge of the HU input to its next falling edge (360 electrical degrees). This period is then used as 360° phase data for the next modulation.

A total of 192 ticks comprise 360 electrical degrees; the length of a tick equals 1/192nds the time period of the immediately preceding 360° phase.

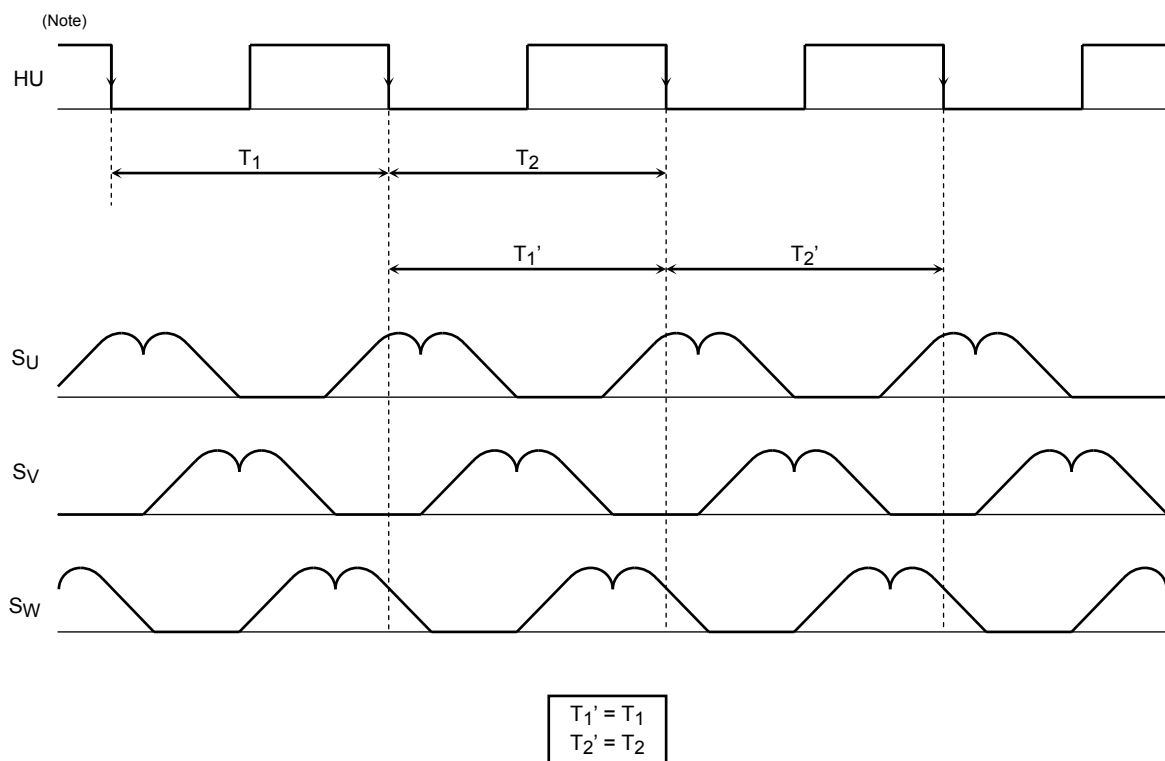

In the above diagram, the modulated waveforms have an interval (T_1') that is equal to the interval between a falling edge of HU to its next falling edge (T_1) of the previous cycle. If there is not an HU falling edge before T_1' ends, T_2' becomes equal to T_1' until the next falling edge of HU.

Modulation is reset on each falling edge of HU, which occurs every 360 electrical degrees. While the motor is accelerating or decelerating, the modulated waveform becomes discontinuous upon each reset.

Note: In the above diagram, hall signals are shown as square waveforms for the sake of simplicity.

Modulated when ALA = L

The hall signals from Hall sensors are modulated, and the modulated signals are then compared against a triangular waveform to generate a sinusoidal PWM waveform.

The counter measures the period from a given rising edge (falling edge) of three Hall signals to its next falling edge (rising edge) where electrical angle is 60°. This period is then used as 60° phase data for the next modulation. A total of 32 ticks comprise 60 electrical degrees; the length of a tick equals 1/32nds the time period of the immediately preceding 60° phase.

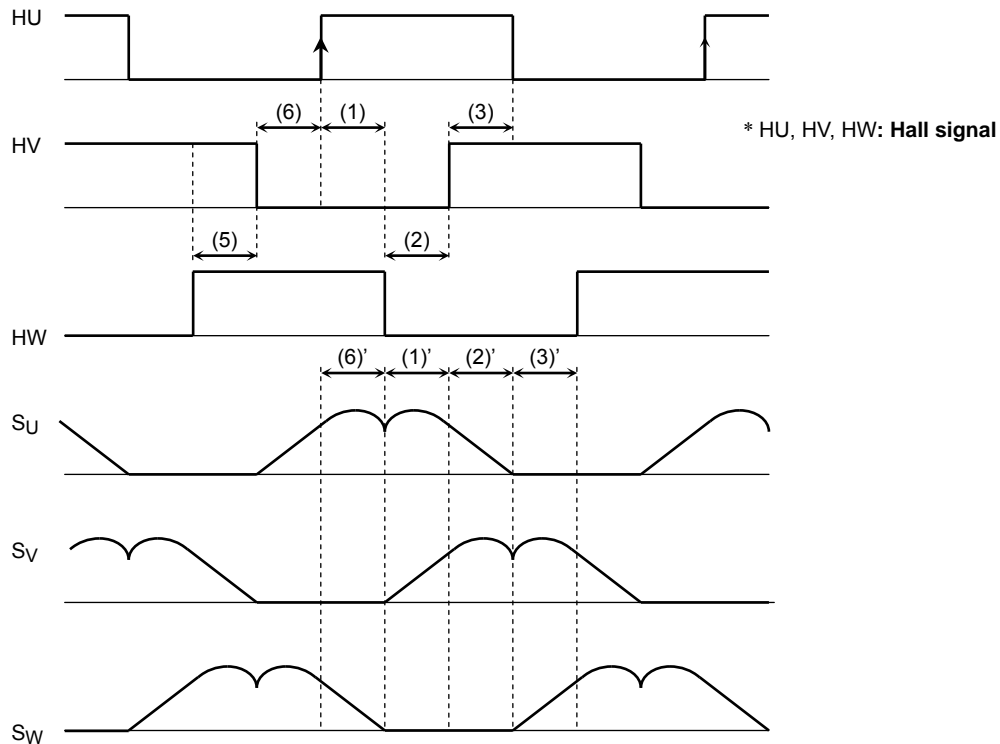

In the above diagram, the modulated waveforms have an interval (1)' that is equal to the interval between a rising edge of HU to a falling edge of HW (1) of the previous cycle. In the same way, the modulated waveforms have an interval (2)' that is equal to the interval between a falling edge of HW to a rising edge of HV (2) of the previous cycle. If there is not a next edge before 32 ticks end, next 32 ticks become equal to the next period until the next edge.

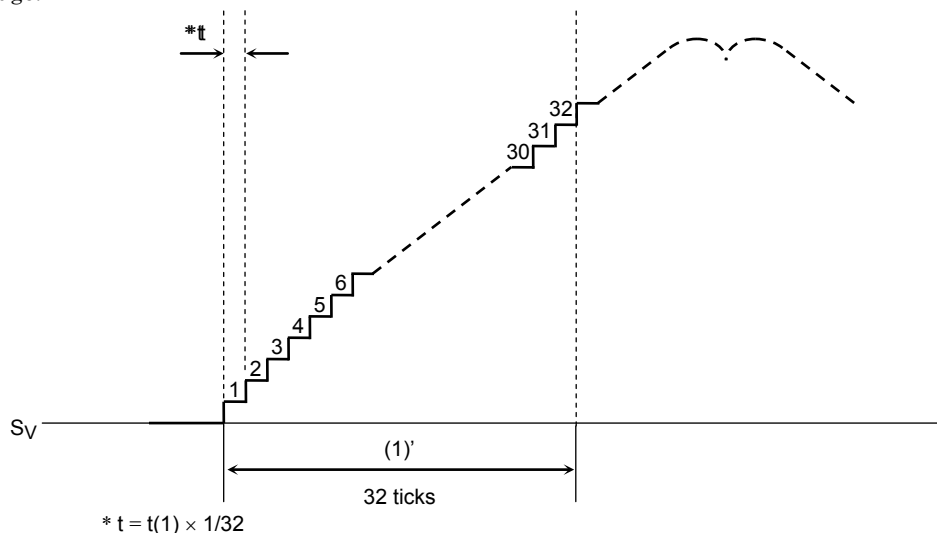

Phase matching between the hall signal and the modulated waveform is carried out for every zero cross of the hall signal.

Modulation is reset on each rising edge and falling edge of the hall signal, which occurs every 60 electrical degrees. While Hall signal is shifted or the motor is accelerating or decelerating, the modulated waveform becomes discontinuous upon each reset.

Note: Square waveforms are used in the above diagram for the sake of simplicity.

Forward rotation timing chart (CW/CCW = L, LA = GND)

(Non-inverted hall signal inputs)

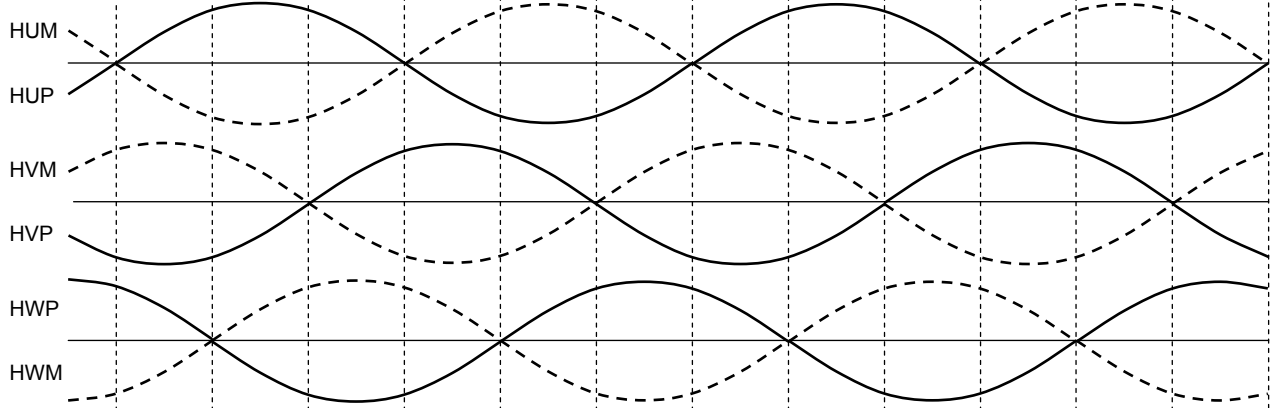

0 < Hall signals < 5.7 Hz
(120° commutation)

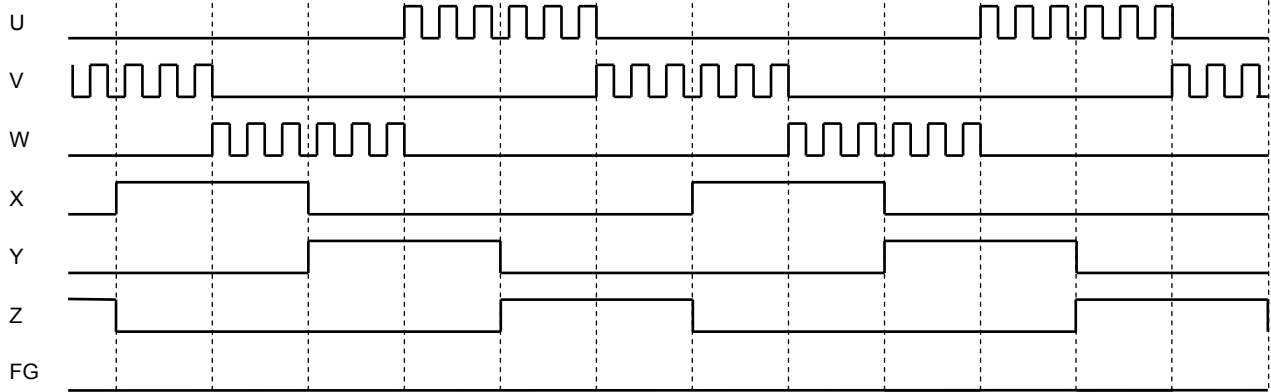

5.7 Hz ≤ Hall signals
(180° commutation: Modulated waveforms in the IC)

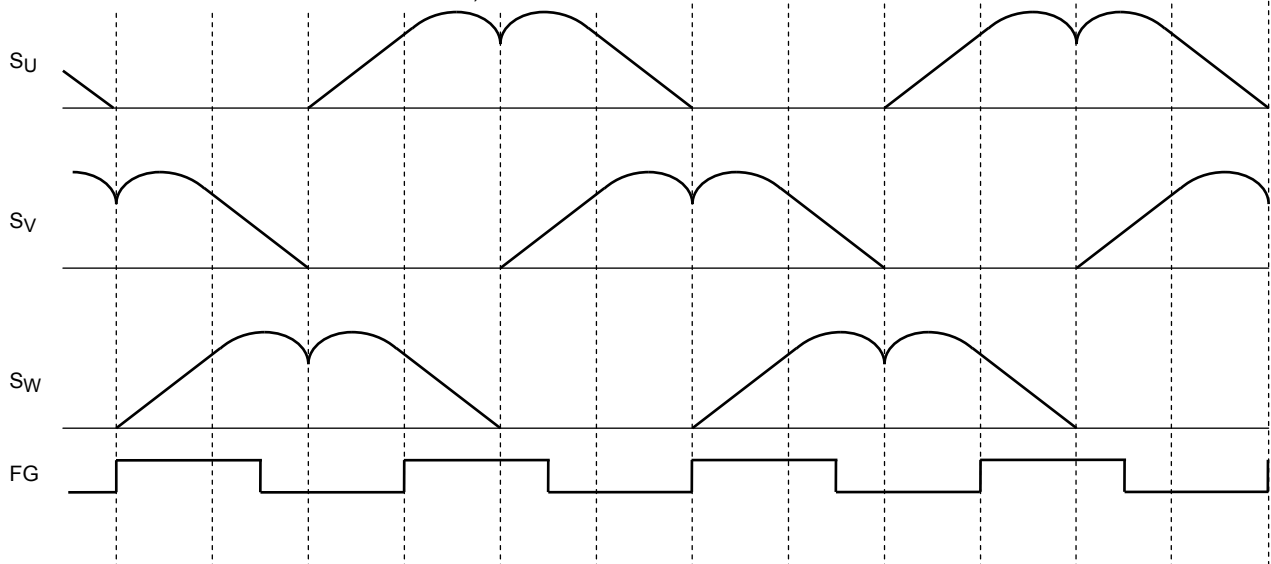

*: When the Hall input frequency is 5.7 Hz or more (@ $f_{osc} = 4.5$ MHz), lead angle control is activated according to the LA input.

The above timing chart is simplified to illustrate the function and behavior of the device.

Forward rotation timing chart (CW/CCW = L, LA = GND)

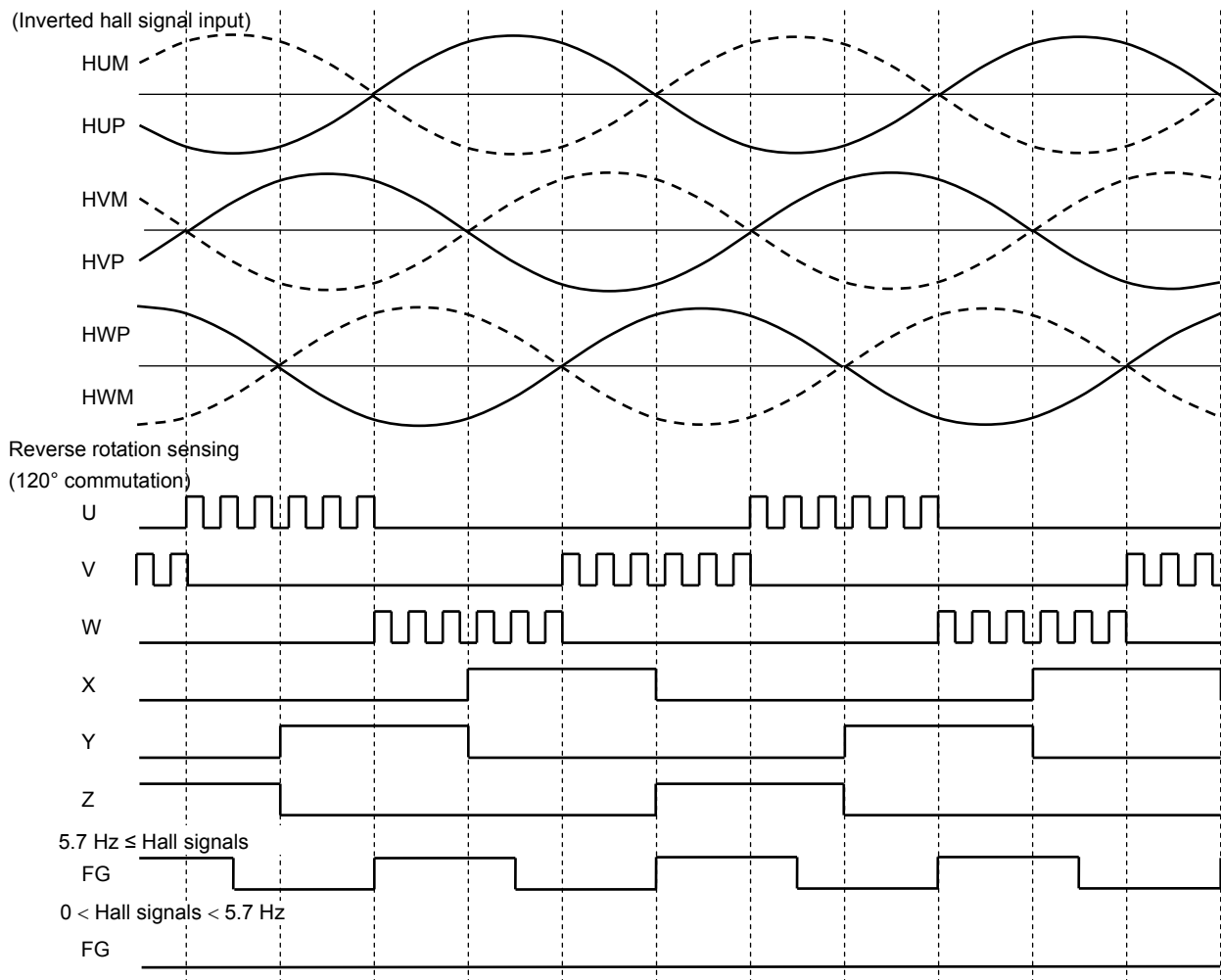

*: When CW/CCW = L, inverted Hall signals put the TB67B054FTG in 120° commutation mode with a lead angle of 0° (reverse rotation).

The above timing chart is simplified to illustrate the function and behavior of the device.

Reverse rotation timing chart (CW/CCW = H, LA = GND)

(Inverted hall signal input)

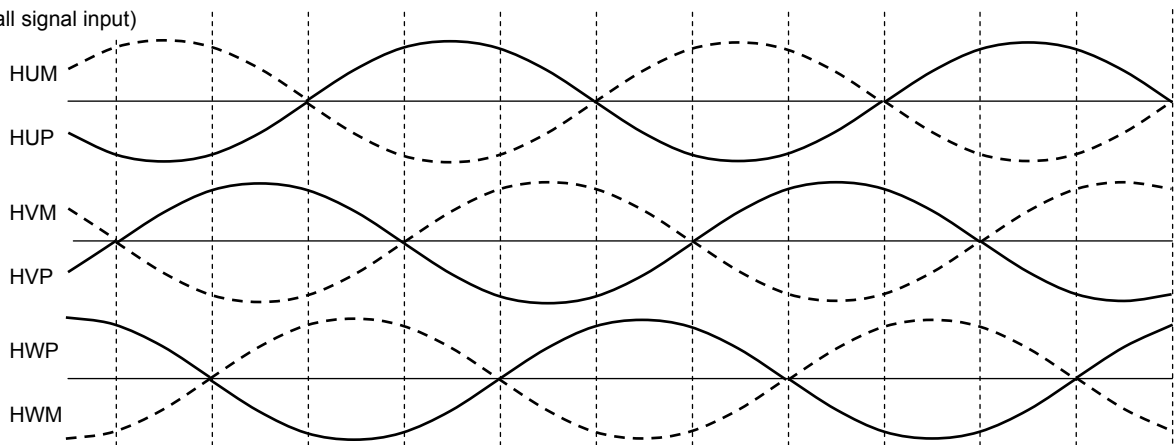

$0 < \text{Hall signals} < 5.7 \text{ Hz}$
(120° commutation)

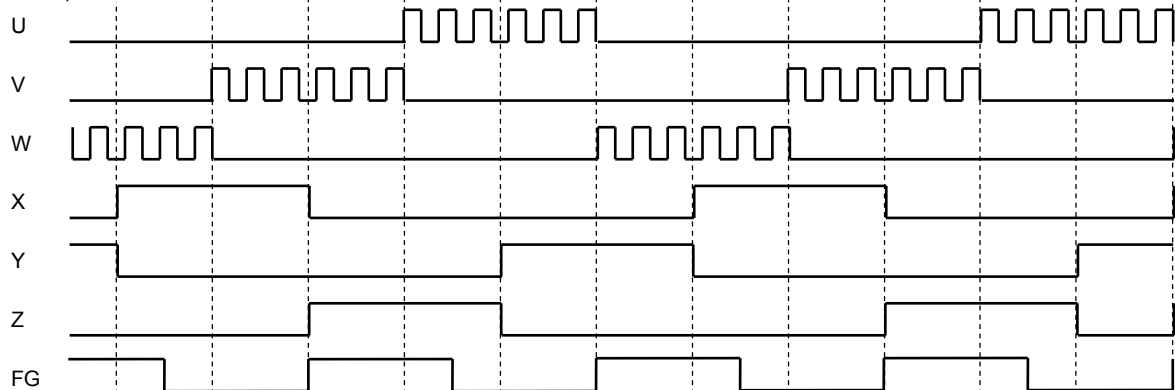

$5.7 \text{ Hz} \leq \text{Hall signals}$
(180° commutation: Modulated waveforms in the IC)

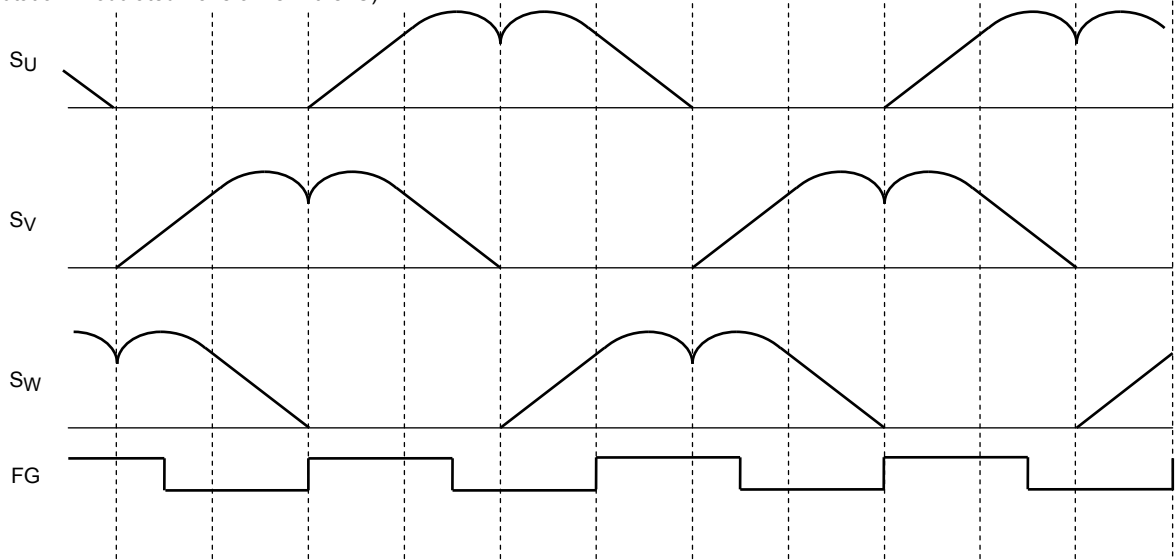

*: When the Hall input frequency is 5.7 Hz or more (@ fosc = 4.5 MHz), lead angle control is activated according to the LA input.

The above timing chart is simplified to illustrate the function and behavior of the device.

Reverse rotation timing chart (CW/CCW = H, LA = GND)

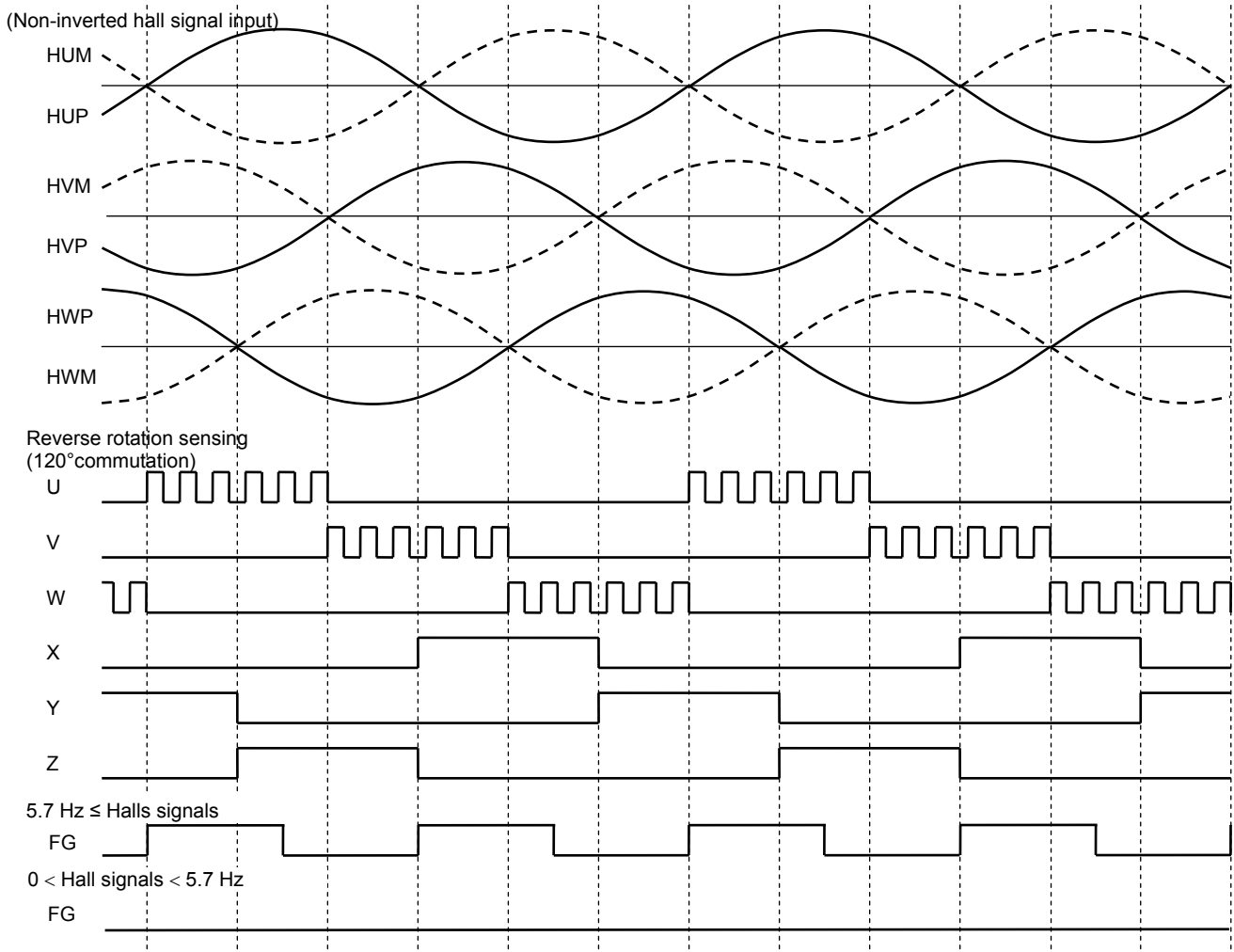

*: When CW/CCW = H, non-inverted Hall signals put the TB67B054FTG in 120° commutation mode with a lead angle of 0° (reverse rotation).

The above timing chart is simplified to illustrate the function and behavior of the device.

Square-wave drive waveform (CW/CCW = L)

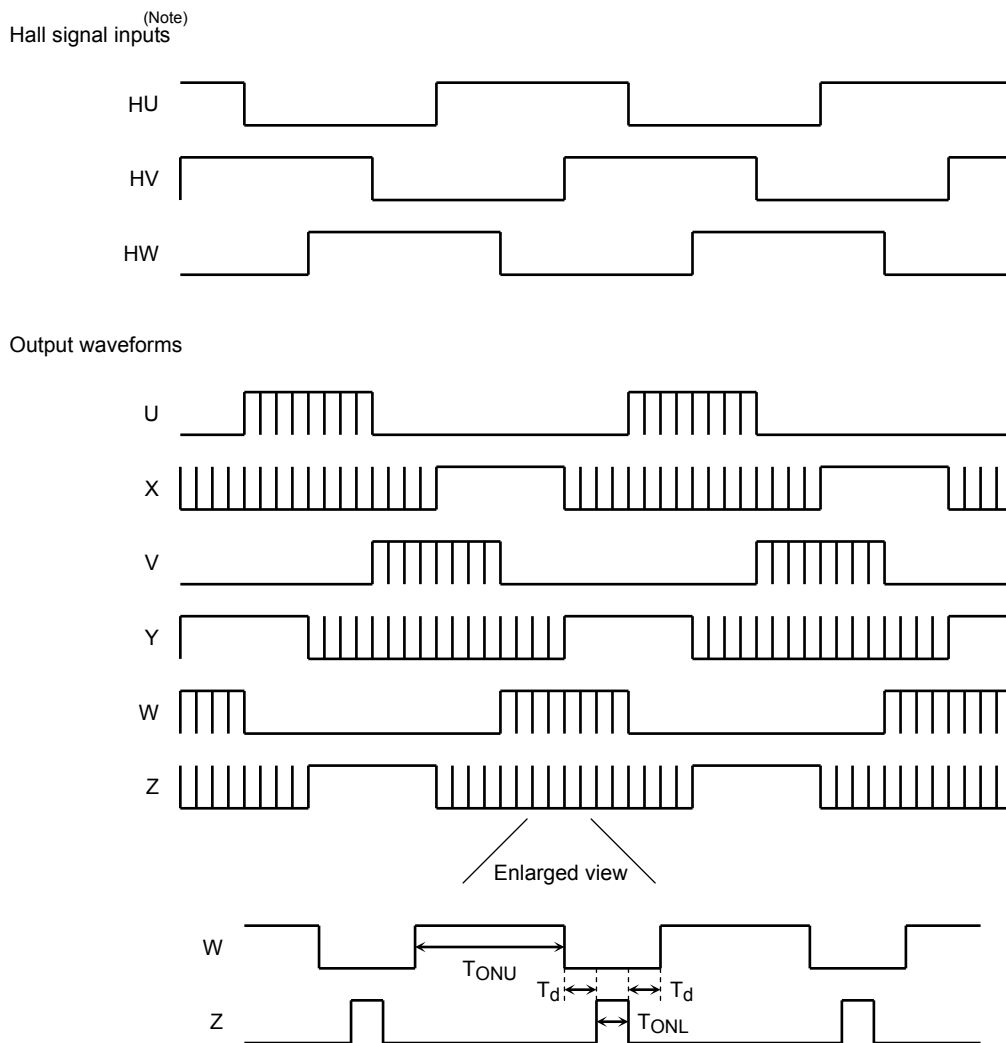

Note: Square waveforms are used in the above diagram for the sake of simplicity.

To obtain an adequate bootstrap voltage, the low-side outputs (X, Y and Z) are always turned on for eight percent of the carrier period (T_{ONL}) even during the off time of the low side in 120° commutation mode. As shown in the enlarged view, the high-side outputs (U, V and W) are turned off for a dead time period while the low-side outputs are on. (T_d varies with the V_{sp} input.)

$$\text{Carrier frequency} = f_{osc}/252 \text{ (Hz)} \quad \text{Dead time: } T_d = 9/f_{osc} \text{ (s)} \text{ (} V_{sp} \geq 5.0 \text{ V)}$$

$$T_{ONL} = \text{carrier period} \times 8\% \text{ (s)} \text{ (constant regardless of the } V_{sp} \text{ input)}$$

In square-wave drive mode, the changing of the motor speed is enabled, depending on the V_{sp} voltage; the motor speed is determined by the duty cycle of T_{ONU} . (See the Square-wave drive mode diagram on page 14.)

Note: At startup, the motor is driven by a square wave when the Hall signal frequency is less than 5.7 Hz (@ $f_{osc} = 4.5 \text{ MHz}$) and when the motor is rotating in the direction reverse to the settings of the TB67B054FTG (REV = H).

Sine-wave drive waveform (CW/CCW = L)

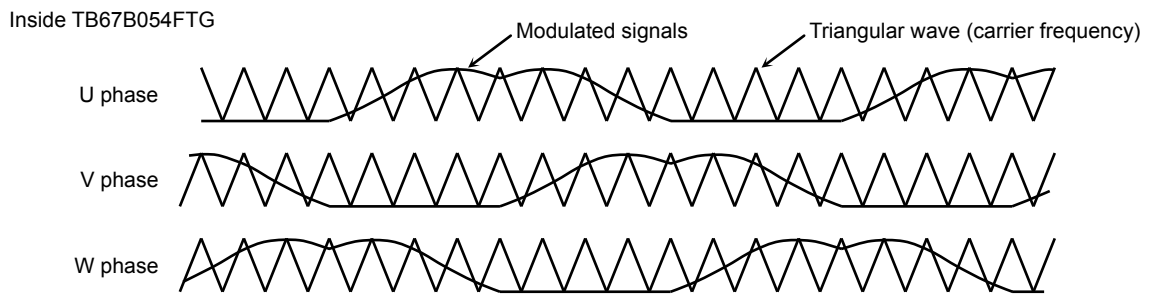

Output waveforms

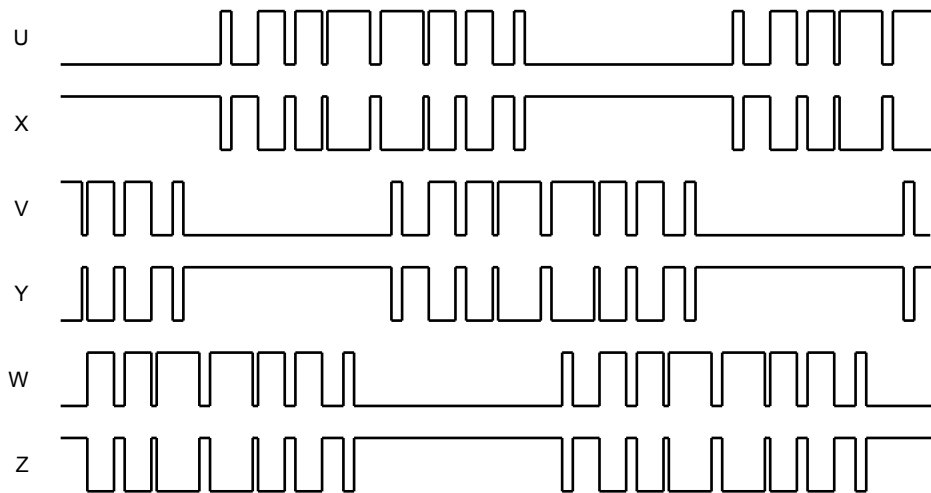

Phase voltage differences

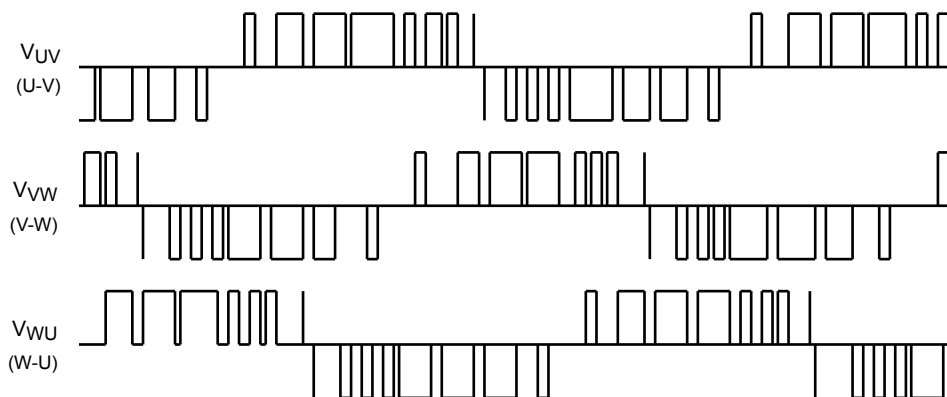

In sine-wave drive mode, the amplitude of the modulated signals varies with the V_{sp} voltage and the motor speed changes with the conduction duty cycle of the output waveforms. (See the Sine-wave drive mode diagram on page 14.)

$$\text{Triangular wave frequency} = \text{carrier frequency} = f_{osc}/252 \text{ (Hz)}$$

Note: At startup, the motor is driven by a sine wave when the Hall signal frequency is 5.7 Hz or more (@ $f_{osc} = 4.5 \text{ MHz}$) and when the motor is rotating in the same direction as settings of the TB67B054FTG (REV = L).

Application circuit example

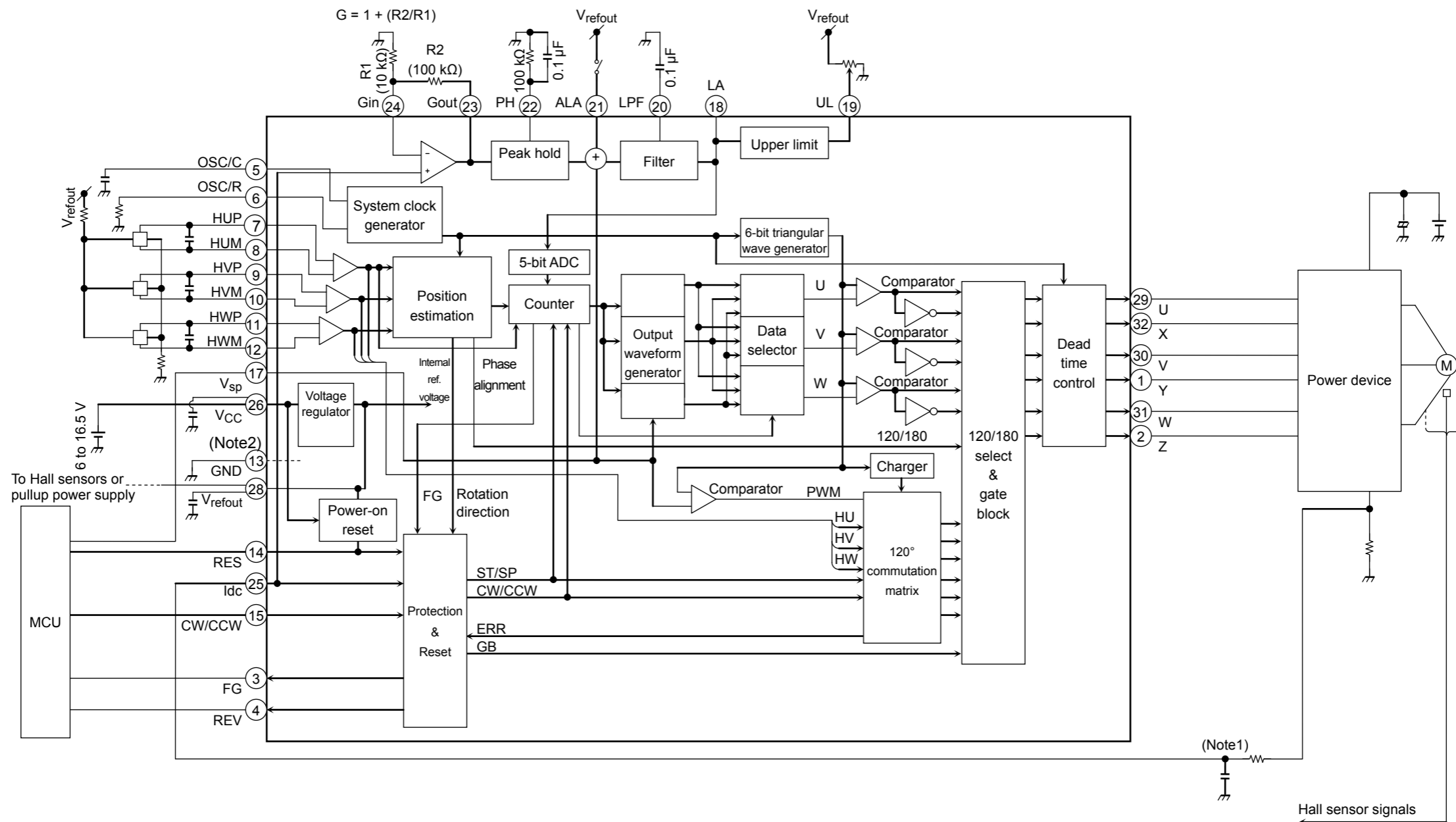

Note1: Connect to ground as necessary to prevent IC malfunction due to noise.

Note2: Connect GND to signal ground on the application circuit.

Note3: Utmost care is required in the design of the output, V_{CC}, and GND lines since the IC may shatter or occur fire, or over voltage or over current may be applied to peripheral components due to short-circuits between outputs, short to V_{CC} or short to ground.
The IC may also shatter or occur fire when it is installed in a wrong orientation.

Package dimensions

P-VQFN32-0505-0.50-005

Unit: mm

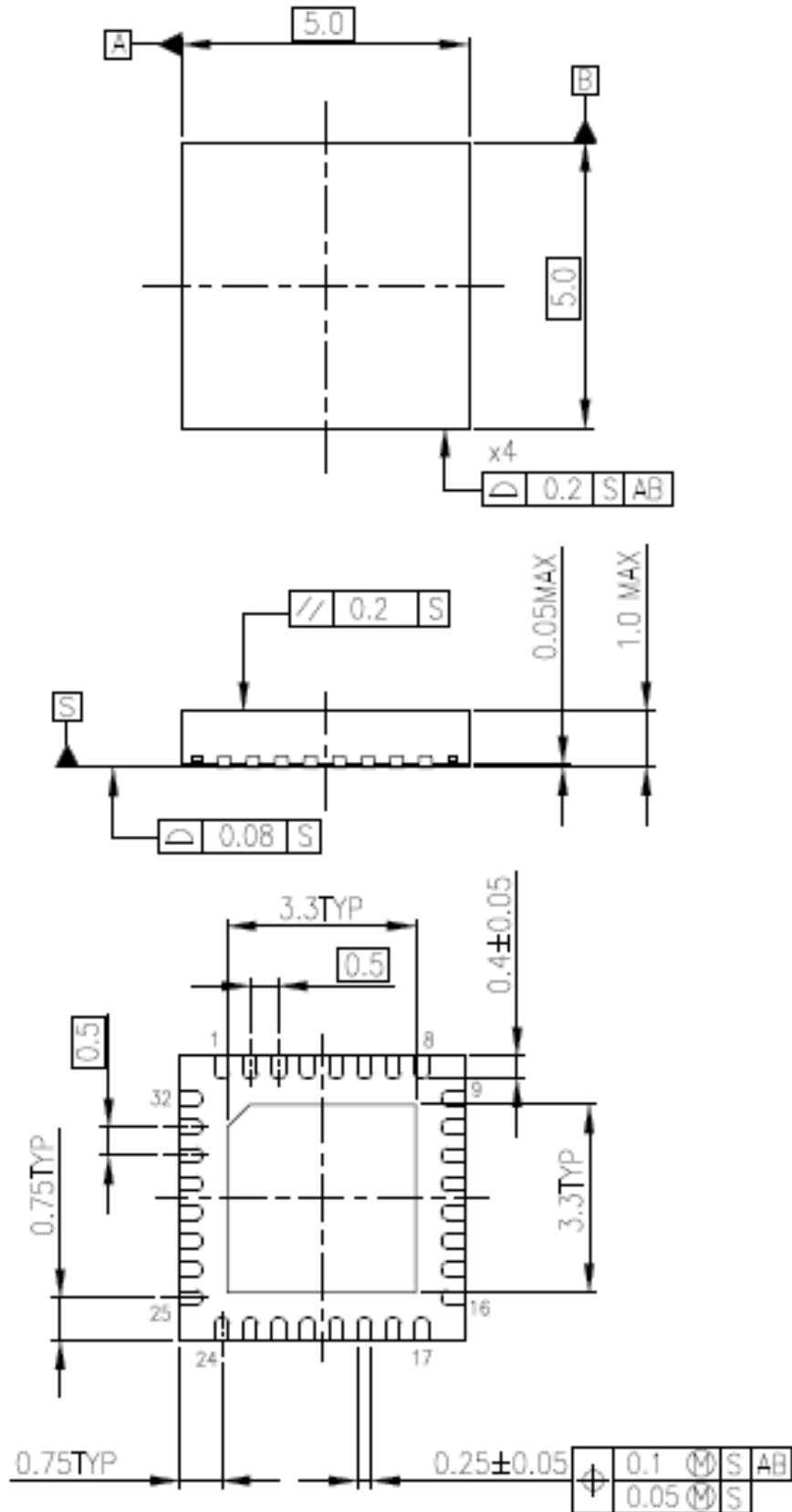

Weight: 0.07 g (typ.)

Notes on Contents

1. Block Diagrams

Some of the functional blocks, circuits, or constants in the block diagram may be omitted or simplified for explanatory purposes.

2. Equivalent Circuits

The equivalent circuit diagrams may be simplified or some parts of them may be omitted for explanatory purposes.

3. Timing Charts

Timing charts may be simplified for explanatory purposes.

4. Application Circuits

The application circuits shown in this document are provided for reference purposes only. Thorough evaluation is required, especially at the mass production design stage.

Providing these application circuit examples does not grant a license for industrial property rights.

IC Usage Considerations

Notes on handling of ICs

- (1) The absolute maximum ratings of a semiconductor device are a set of ratings that must not be exceeded, even for a moment. Do not exceed any of these ratings.
Exceeding the rating(s) may cause the device breakdown, damage or deterioration, and may result injury by explosion or combustion.
- (2) Use an appropriate power supply fuse to ensure that a large current does not continuously flow in case of over current and/or IC failure. The IC will fully break down when used under conditions that exceed its absolute maximum ratings, when the wiring is routed improperly or when an abnormal pulse noise occurs from the wiring or load, causing a large current to continuously flow and the breakdown can lead smoke or ignition. To minimize the effects of the flow of a large current in case of breakdown, appropriate settings, such as fuse capacity, fusing time and insertion circuit location, are required.
- (3) If your design includes an inductive load such as a motor coil, incorporate a protection circuit into the design to prevent device malfunction or breakdown caused by the current resulting from the inrush current at power ON or the negative current resulting from the back electromotive force at power OFF. IC breakdown may cause injury, smoke or ignition.
Use a stable power supply with ICs with built-in protection functions. If the power supply is unstable, the protection function may not operate, causing IC breakdown. IC breakdown may cause injury, smoke or ignition.
- (4) Do not insert devices in the wrong orientation or incorrectly.
Make sure that the positive and negative terminals of power supplies are connected properly. Otherwise, the current or power consumption may exceed the absolute maximum rating, and exceeding the rating(s) may cause the device breakdown, damage or deterioration, and may result injury by explosion or combustion.
In addition, do not use any device that is applied the current with inserting in the wrong orientation or incorrectly even just one time.

Points to Remember on Handling of ICs

- (1) Over current protection circuit
Over current protection circuits (referred to as current limiter circuits) do not necessarily protect ICs under all circumstances. If the Over current protection circuits operate against the over current, clear the over current status immediately.
Depending on the method of use and usage conditions, such as exceeding absolute maximum ratings can cause the over current protection circuit to not operate properly or IC breakdown before operation. In addition, depending on the method of use and usage conditions, if over current continues to flow for a long time after operation, the IC may generate heat resulting in breakdown.
- (2) Heat radiation design
In using an IC with large current flow such as power amp, regulator or driver, please design the device so that heat is appropriately radiated, not to exceed the specified junction temperature (T_J) at any time and condition. These ICs generate heat even during normal use. An inadequate IC heat radiation design can lead to decrease in IC life, deterioration of IC characteristics or IC breakdown. In addition, please design the device taking into considerate the effect of IC heat radiation with peripheral components.
- (3) Back-EMF
When a motor rotates in the reverse direction, stops or slows down abruptly, a current flow back to the motor's power supply due to the effect of back-EMF. If the current sink capability of the power supply is small, the device's motor power supply and output pins might be exposed to conditions beyond absolute maximum ratings. To avoid this problem, take the effect of back-EMF into consideration in system design.

RESTRICTIONS ON PRODUCT USE

Toshiba Corporation and its subsidiaries and affiliates are collectively referred to as "TOSHIBA".

Hardware, software and systems described in this document are collectively referred to as "Product".

- TOSHIBA reserves the right to make changes to the information in this document and related Product without notice.
- This document and any information herein may not be reproduced without prior written permission from TOSHIBA. Even with TOSHIBA's written permission, reproduction is permissible only if reproduction is without alteration/omission.
- Though TOSHIBA works continually to improve Product's quality and reliability, Product can malfunction or fail. Customers are responsible for complying with safety standards and for providing adequate designs and safeguards for their hardware, software and systems which minimize risk and avoid situations in which a malfunction or failure of Product could cause loss of human life, bodily injury or damage to property, including data loss or corruption. Before customers use the Product, create designs including the Product, or incorporate the Product into their own applications, customers must also refer to and comply with (a) the latest versions of all relevant TOSHIBA information, including without limitation, this document, the specifications, the data sheets and application notes for Product and the precautions and conditions set forth in the "TOSHIBA Semiconductor Reliability Handbook" and (b) the instructions for the application with which the Product will be used with or for. Customers are solely responsible for all aspects of their own product design or applications, including but not limited to (a) determining the appropriateness of the use of this Product in such design or applications; (b) evaluating and determining the applicability of any information contained in this document, or in charts, diagrams, programs, algorithms, sample application circuits, or any other referenced documents; and (c) validating all operating parameters for such designs and applications. **TOSHIBA ASSUMES NO LIABILITY FOR CUSTOMERS' PRODUCT DESIGN OR APPLICATIONS.**
- **PRODUCT IS NEITHER INTENDED NOR WARRANTED FOR USE IN EQUIPMENTS OR SYSTEMS THAT REQUIRE EXTRAORDINARILY HIGH LEVELS OF QUALITY AND/OR RELIABILITY, AND/OR A MALFUNCTION OR FAILURE OF WHICH MAY CAUSE LOSS OF HUMAN LIFE, BODILY INJURY, SERIOUS PROPERTY DAMAGE AND/OR SERIOUS PUBLIC IMPACT ("UNINTENDED USE").** Except for specific applications as expressly stated in this document, Unintended Use includes, without limitation, equipment used in nuclear facilities, equipment used in the aerospace industry, medical equipment, equipment used for automobiles, trains, ships and other transportation, traffic signaling equipment, equipment used to control combustions or explosions, safety devices, elevators and escalators, devices related to electric power, and equipment used in finance-related fields. **IF YOU USE PRODUCT FOR UNINTENDED USE, TOSHIBA ASSUMES NO LIABILITY FOR PRODUCT.** For details, please contact your TOSHIBA sales representative.
- Do not disassemble, analyze, reverse-engineer, alter, modify, translate or copy Product, whether in whole or in part.
- Product shall not be used for or incorporated into any products or systems whose manufacture, use, or sale is prohibited under any applicable laws or regulations.
- The information contained herein is presented only as guidance for Product use. No responsibility is assumed by TOSHIBA for any infringement of patents or any other intellectual property rights of third parties that may result from the use of Product. No license to any intellectual property right is granted by this document, whether express or implied, by estoppel or otherwise.
- **ABSENT A WRITTEN SIGNED AGREEMENT, EXCEPT AS PROVIDED IN THE RELEVANT TERMS AND CONDITIONS OF SALE FOR PRODUCT, AND TO THE MAXIMUM EXTENT ALLOWABLE BY LAW, TOSHIBA (1) ASSUMES NO LIABILITY WHATSOEVER, INCLUDING WITHOUT LIMITATION, INDIRECT, CONSEQUENTIAL, SPECIAL, OR INCIDENTAL DAMAGES OR LOSS, INCLUDING WITHOUT LIMITATION, LOSS OF PROFITS, LOSS OF OPPORTUNITIES, BUSINESS INTERRUPTION AND LOSS OF DATA, AND (2) DISCLAIMS ANY AND ALL EXPRESS OR IMPLIED WARRANTIES AND CONDITIONS RELATED TO SALE, USE OF PRODUCT, OR INFORMATION, INCLUDING WARRANTIES OR CONDITIONS OF MERCHANTABILITY, FITNESS FOR A PARTICULAR PURPOSE, ACCURACY OF INFORMATION, OR NONINFRINGEMENT.**
- Do not use or otherwise make available Product or related software or technology for any military purposes, including without limitation, for the design, development, use, stockpiling or manufacturing of nuclear, chemical, or biological weapons or missile technology products (mass destruction weapons). Product and related software and technology may be controlled under the applicable export laws and regulations including, without limitation, the Japanese Foreign Exchange and Foreign Trade Law and the U.S. Export Administration Regulations. Export and re-export of Product or related software or technology are strictly prohibited except in compliance with all applicable export laws and regulations.
- Please contact your TOSHIBA sales representative for details as to environmental matters such as the RoHS compatibility of Product. Please use Product in compliance with all applicable laws and regulations that regulate the inclusion or use of controlled substances, including without limitation, the EU RoHS Directive. **TOSHIBA ASSUMES NO LIABILITY FOR DAMAGES OR LOSSES OCCURRING AS A RESULT OF NONCOMPLIANCE WITH APPLICABLE LAWS AND REGULATIONS.**

单击下面可查看定价，库存，交付和生命周期等信息

[>>Toshiba\(东芝\)](#)