

TOSHIBA CMOS Linear Integrated Circuit Silicon Monolithic

TCR13AGADJ

1.3 A CMOS Ultra Low Dropout Regulator

The TCR13AGADJ is CMOS single output voltage regulator with an on/off control input, featuring ultra low dropout voltage, low inrush current and fast load transient response.

This voltage regulator is available in output voltage adjustable type from 0.55 V to 3.6 V and capable of driving up to 1.3 A.

Other features include overcurrent protection, thermal shutdown, inrush current reduction, under voltage lockout and auto-discharge.

The TCR13AGADJ is offered in the ultra small package WCSP6F (0.8 mm x 1.2 mm (typ.), t: 0.33 mm (max))

As small ceramic input and output capacitors can be used with the TCR13AGADJ, this device is ideal for portable applications that require high-density board assembly such as cellular phones.

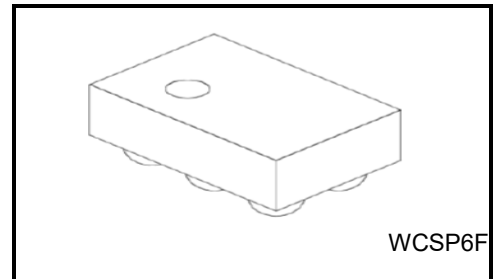

Weight : 0.61 mg (typ.)

Features

- Low dropout voltage
 - $V_{DO} = 92 \text{ mV (typ.)}$ at 0.9 V output, $V_{BIAS} = 3.3 \text{ V}$, $I_{OUT} = 1.0 \text{ A}$
 - $V_{DO} = 9.2 \text{ mV (typ.)}$ at 0.9 V output, $V_{BIAS} = 3.3 \text{ V}$, $I_{OUT} = 0.1 \text{ A}$
- Wide range output voltage (Adjustable from 0.55 V to 3.6 V)
- Fast load transient response $-100 / +115 \text{ mV (typ.)}$ at 0.01 A \Rightarrow 1 A, $C_{OUT} \geq 4.7 \mu\text{F}$
- Overcurrent protection
- Thermal shutdown
- Inrush current reduction
- Under voltage lockout
- Soft start function
- Auto-discharge
- Pull down connection between CONTROL and GND
- Ultra small package WCSP6F (0.8 mm x 1.2 mm (typ.), t: 0.33 mm (max))
- Stable with over 4.7 μF Input capacitor, 1.0 μF Bias capacitor and 4.7 μF output ceramic capacitor

Notice

This device is sensitive to electrostatic discharge.
Please ensure equipment, operator and tools are adequately earthed when handling.

Start of commercial production
2016-11

Absolute Maximum Ratings (Ta = 25°C)

Characteristics	Symbol	Rating	Unit
Bias voltage	V _{BIAS}	6.0	V
Input voltage	V _{IN}	6.0	V
Control voltage	V _{CT}	-0.3 to 6.0	V
Adjustable voltage	V _{ADJ}	-0.3 to 6.0	V
Output voltage	V _{OUT}	-0.3 to V _{IN} + 0.3 ≤ 6.0	V
Power dissipation	P _D	1.9 (Note 1)	W
Junction temperature	T _j	150	°C
Storage temperature range	T _{stg}	-55 to 150	°C

Note: Using continuously under heavy loads (e.g. the application of high temperature/current/voltage and the significant change in temperature, etc.) may cause this product to decrease in the reliability significantly even if the operating conditions (i.e. operating temperature/current/voltage, etc.) are within the absolute maximum ratings and the operating ranges.

Please design the appropriate reliability upon reviewing the Toshiba Semiconductor Reliability Handbook (“Handling Precautions”/“Derating Concept and Methods”) and individual reliability data (i.e. reliability test report and estimated failure rate, etc).

Note 1: Rating at mounting on a board
(Glass epoxy board (FR4) dimension: 40 mm x 40 mm (4 layer), t = 1.8 mm)

Operating Ranges

Characteristics	Symbol	Rating	Unit
Bias voltage	V _{BIAS}	V _{OUT} ≤ 1.1 V, I _{OUT} = 1 mA	2.5 to 5.5
		V _{OUT} > 1.1 V, I _{OUT} = 1 mA	V _{OUT} + 1.4 V to 5.5
Input voltage	V _{IN}	V _{OUT} + 0.1 V to V _{BIAS} (Note 2)	V
Control voltage	V _{CT}	-0.3 to V _{BIAS}	V
Output voltage	V _{OUT}	0.55 to 3.6 (Note 3)	V
Output current	I _{OUT}	1.3 (Max) (Note 4)	A
Operation Temperature	T _{opr}	-40 to 85	°C
C _{OUT}	C _{OUT}	≥ 4.7μF	—
C _{IN}	C _{IN}	≥ 4.7μF	—
C _{BIAS}	C _{BIAS}	≥ 1.0μF	—

Note 2: I_{OUT} = 1 mA.

Please use within Absolute Maximum Ratings Junction temperature and Operation Temperature Ranges.

Note 3: Output voltage adjustable type. Please refer to Application Note (Page 7).

Note 4: Do not operate at or near the maximum ratings of operating ranges for extended periods of time. Exposure to such conditions may adversely impact product reliability and results in failures not covered by warranty.

Maximum output current of operating ranges table is defined as lifetime average junction temperature of +45°C where maximum output current = lifetime average current to avoid electro migration.

Pin Assignment (top view)

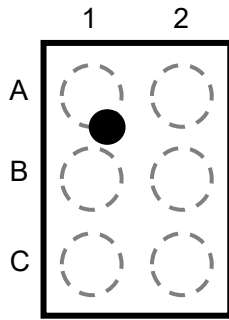

	1	2
A	V _{OUT}	V _{IN}
B	V _{ADJ}	CONTROL
C	GND	V _{BIAS}

Top Marking (top view)

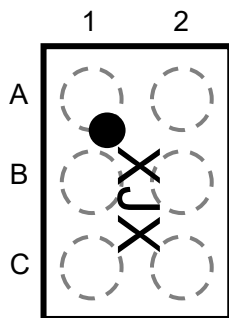

Block Diagram

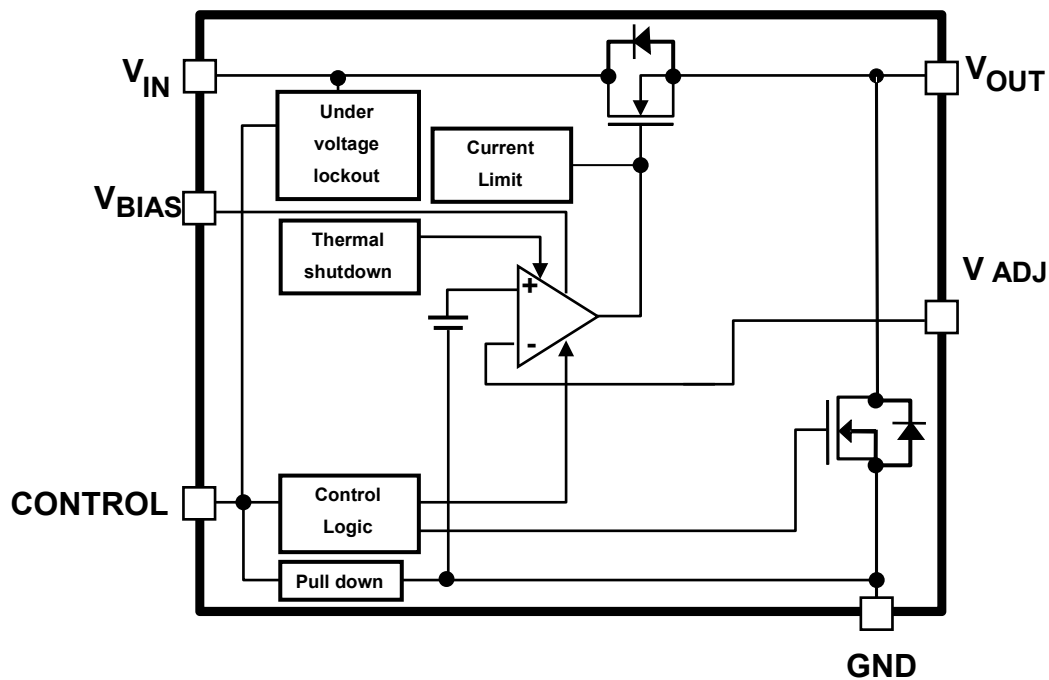

Operation Logic table

Control inputs	Output voltage(V)
High	V_{OUT}
Low	0 V (Output discharge)

Electrical Characteristics

(Unless otherwise specified, $V_{IN} = V_{OUT} + 0.5\text{ V}$, $I_{OUT} = 50\text{ mA}$, $C_{IN} = 4.7\text{ }\mu\text{F}$, $C_{BIAS} = 1.0\text{ }\mu\text{F}$, $C_{OUT} = 4.7\text{ }\mu\text{F}$)

Characteristics	Symbol	Test Condition	$T_j = 25^\circ\text{C}$			$T_j = -40\text{ to }85^\circ\text{C}$ (Note 8)		Unit
			Min	Typ.	Max	Min	Max	
Bias voltage	V_{BIAS}	$V_{OUT} \leq 1.1\text{ V}$, $I_{OUT} = 1\text{ mA}$	2.5	—	5.5	2.5	5.5	V
		$V_{OUT} > 1.1\text{ V}$, $I_{OUT} = 1\text{ mA}$	$V_{OUT} + 1.4\text{ V}$	—	5.5	$V_{OUT} + 1.4\text{ V}$	5.5	V
Input voltage	V_{IN}	$I_{OUT} = 1\text{ mA}$ (Note 5)	$V_{OUT} + 0.1\text{ V}$	—	V_{BIAS}	$V_{OUT} + 0.1\text{ V}$	V_{BIAS}	V
Adjustable voltage	V_{ADJ}	—	0.490	0.500	0.510	—	—	V
Line regulation	Reg·line	$V_{OUT} + 0.5\text{ V} \leq V_{IN} \leq 5.5\text{ V}$, $I_{OUT} = 1\text{ mA}$	—	1	15	—	—	mV
Load regulation	Reg·load	$0.01\text{ A} \leq I_{OUT} \leq 1\text{ A}$	—	2	—	—	—	mV
Quiescent current	I_B	$I_{OUT} = 0\text{ mA}$, $V_{BIAS} = 2.5\text{ V}$ (Note 6)	—	56	72	—	92	μA
Stand-by current	$I_{BIAS}(\text{OFF})$	$V_{CT} = 0\text{ V}$	—	0.1	—	—	1	μA
	$I_{IN}(\text{OFF})$	$V_{CT} = 0\text{ V}$ (Note 6)	—	0.8	—	—	2	μA
Control pull down current	I_{CT}	—	—	0.1	—	—	—	μA
Dropout voltage	V_{DO}	$I_{OUT} = 1\text{ A}$, $V_{BIAS} = 3.3\text{ V}$ (Note 7)(Note 9)	—	92	—	—	163	mV
Under voltage lockout	V_{UVLO}	V_{IN} voltage	—	0.5	—	—	0.65	V
Temperature coefficient	T_{CVO}	$-40^\circ\text{C} \leq T_{opr} \leq 85^\circ\text{C}$	—	60	—	—	—	ppm/ $^\circ\text{C}$
Output noise voltage	V_{NO}	$V_{BIAS} = 5.5\text{ V}$, $V_{IN} = V_{OUT} + 1\text{ V}$, $I_{OUT} = 10\text{ mA}$, $10\text{ Hz} \leq f \leq 100\text{ kHz}$, (Note 7)	—	52	—	—	—	μV_{rms}
Ripple rejection ratio	R.R.(V_{IN})	$V_{BIAS} = 5.5\text{ V}$, $V_{IN} = V_{OUT} + 1\text{ V}$, $I_{OUT} = 10\text{ mA}$, $f = 1\text{ kHz}$, V_{IN} Ripple = 200 mV_{p-p} , (Note 7)	—	90	—	—	—	dB
	R.R.(V_{BIAS})	$V_{BIAS} = 5.5\text{ V}$, $V_{IN} = V_{OUT} + 1\text{ V}$, $I_{OUT} = 10\text{ mA}$, $f = 1\text{ kHz}$, V_{BIAS} Ripple = 200 mV_{p-p} , (Note 7)	—	50	—	—	—	dB
Load transient response	ΔV_{OUT}	$I_{OUT} = 0.01\text{ A} \rightarrow 1\text{ A}$	—	-100	—	—	—	mV
		$I_{OUT} = 1\text{ A} \rightarrow 0.01\text{ A}$	—	+115	—	—	—	mV
Control voltage (ON)	$V_{CT}(\text{ON})$	—	1.0	—	5.5	1.0	5.5	V
Control voltage (OFF)	$V_{CT}(\text{OFF})$	—	0	—	0.4	0	0.4	V
Output discharge on resistance	R_{SD}	—	—	20	—	—	—	Ω

Note 5: Please refer to Dropout voltage vs. Output current (Page 12), and use it within Absolute Maximum Ratings Junction temperature and Operation Temperature Ranges.

Note 6: This parameter is tested at $V_{OUT} = 0.9\text{ V}$.

Control pull down current and external resistors current not included in this parameter.

Note 7: This parameter is tested at $V_{OUT} = 0.9\text{ V}$.

Note 8: This parameter is warranted by design.

Note 9: $V_{DO} = V_{IN1} - (V_{OUT1} - 100\text{ mV})$

V_{OUT1} is the output voltage when $V_{IN} = V_{OUT} + 0.5\text{ V}$.

V_{IN1} is the input voltage at which the output voltage becomes 100 mV drop of V_{OUT1} after gradually decreasing the input voltage

t_{ON} t_{OFF} Characteristics (Ta = 25°C)

V_{OUT} = 1.0 V

Characteristics	Symbol	Test Condition (Figure 1)	Min	Typ.	Max	Unit
Turn on delay	t _{ON}	V _{IN} = 1.235 V , V _{BIAS} = 3.3 V , I _{OUT} = No Load C _{IN} = 4.7 μF, C _{BIAS} = 1.0 μF, C _{OUT} = 4.7 μF	—	135	—	μs
Turn off delay	t _{OFF}	V _{IN} = 1.235 V , V _{BIAS} = 3.3 V , I _{OUT} = No Load C _{IN} = 4.7 μF, C _{BIAS} = 1.0 μF, C _{OUT} = 4.7 μF	—	230	—	μs

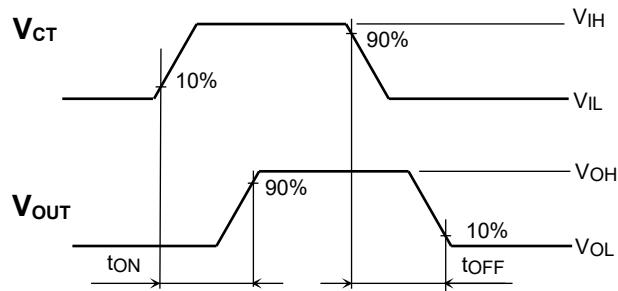
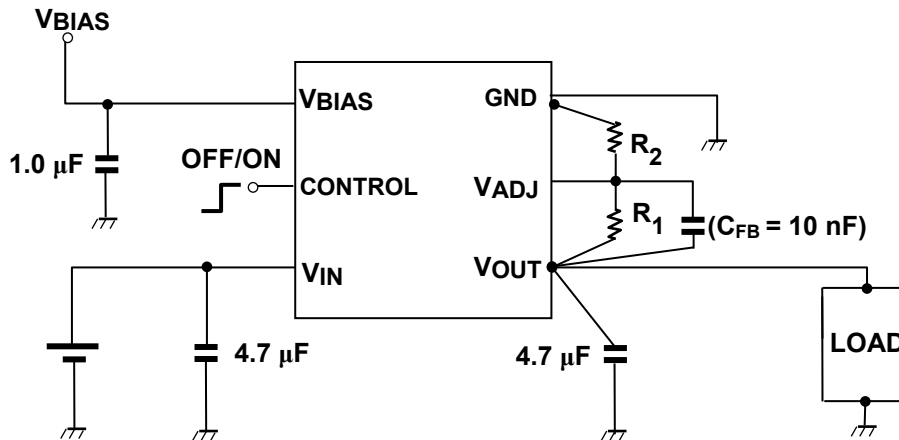

Figure 1 t_{ON}, t_{OFF} Waveforms

Application Note

1. Example of Application Circuit



The figure above shows the recommended configuration for using a Low-Dropout regulator. Please connect over 4.7μF capacitor at VIN and VOUT pins, and over 1μF capacitor at VBIAS pin, as close as possible to each pins for stable input/output operation. (Ceramic capacitors can be used). But simple usage of large input capacitance is known to form unwanted LC resonance in combination with input wire inductance. So please check parameter with the actual device and circuit.

CFB is optional capacitance that improve Transient response, Output noise, Oscillation resistance, PSRR and Overshoot. However, it does not necessarily need.

VADJ is the output voltage control pin. Typical VADJ value is 0.5 V. For best performance R1 and R2 should have similar temperature coefficients, otherwise output voltage accuracy will be compromised.

$$V_{OUT} = V_{ADJ} \times \left(1 + \frac{R1}{R2}\right)$$

Reference resistance table

This is reference data. Please check parameter with the actual device and circuit.

Output voltage (typ.)	R1	R2
0.6 V	4 kΩ	20 kΩ
0.7 V	8 kΩ	20 kΩ
0.8 V	12 kΩ	20 kΩ
0.9 V	16 kΩ	20 kΩ
1.0 V	20 kΩ	20 kΩ
1.1 V	24 kΩ	20 kΩ
1.2 V	28 kΩ	20 kΩ
1.3 V	32 kΩ	20 kΩ
1.8 V	52 kΩ	20 kΩ
3.6 V	124 kΩ	20 kΩ

2. Power Dissipation

Board-mounted power dissipation ratings for TCR13AGADJ is available in the Absolute Maximum Ratings table. Power dissipation is measured on the board condition shown below.

[The Board Condition]

Board material: Glass epoxy (FR4)

Board dimension: 40 mm x 40 mm (4 layer), t = 1.8 mm

Metal pattern ratio: approximately 70 % each layer,

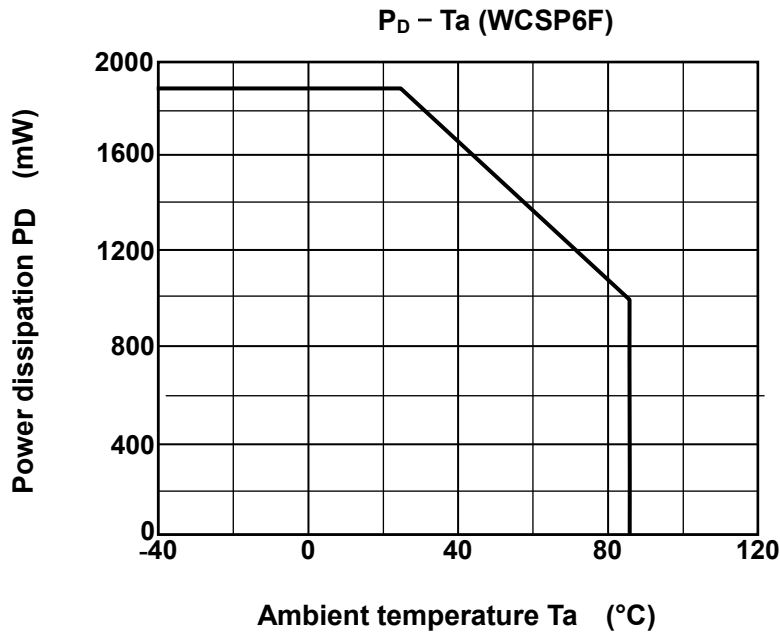

Please allow sufficient margin when designing a board pattern to fit the expected power dissipation. Also take into consideration the ambient temperature, input voltage, output current etc. and applying the appropriate derating for allowable power dissipation during operation.

Attention in Use

- Capacitors(Output, Input, and Bias Capacitor)

Ceramic capacitors can be used for these devices. However, because of the type of the capacitors, there might be unexpected thermal features. Please consider application condition for selecting capacitors. For stable operation, please use over 4.7 μF input capacitor, 1.0 μF bias capacitor and 4.7 μF output ceramic capacitor.

- Mounting

The long distance between IC and each capacitor might affect phase compensation by impedance in wire and inductor. For stable power supply, output capacitor need to mount near IC as much as possible. Also V_{IN} and GND pattern need to be large and make the wire impedance small as possible.

- Permissible Loss

Please have enough design patterns for expected maximum permissible loss. And under consideration of ambient temperature, input voltage, and output current etc, we recommend proper dissipation ratings for maximum permissible loss; in general maximum dissipation rating is 70 to 80 percent.

- Overcurrent Protection and Thermal shutdown

Overcurrent protection and Thermal shutdown are designed in these products, but these are not designed to constantly ensure the suppression of the device within operation limits. Depending on the condition during actual usage, it could affect the electrical characteristic specification and reliability. Also note that if output pins and GND pins are not completely shorted out, these products might break down.

When using these products, please read through and understand the concept of dissipation for absolute maximum ratings from the above mention or our 'Semiconductor Reliability Handbook'. Then use these products under absolute maximum ratings in any condition. Furthermore, Toshiba recommends inserting failsafe system into the design.

- Adjustable output voltage type

TCR13AGADJ is adjustable output voltage type. V_{ADJ} is the output voltage control pin, please refer to example of application circuit and reference resistance table. Please select the tolerance of the resistance value in accordance by the system. In addition, please assemble R1 and R2 to minimize common impedance. For V_{ADJ} assembly, please design PCB pattern as short as possible to avoid noise effect.

Representative Typical Characteristics

Output voltage vs. Input voltage

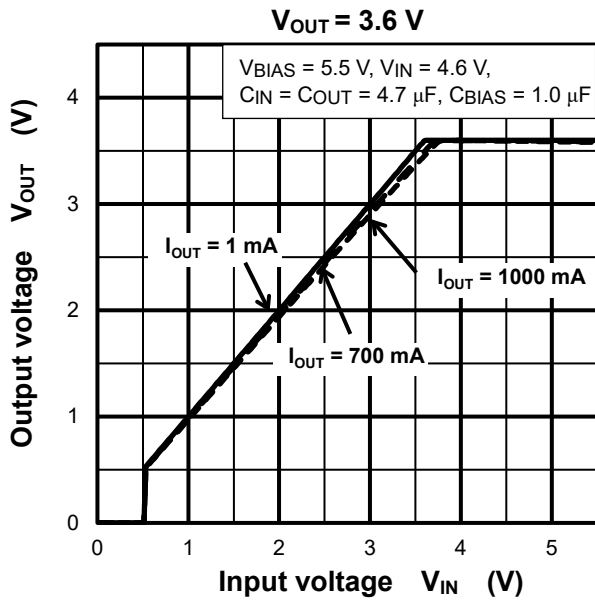
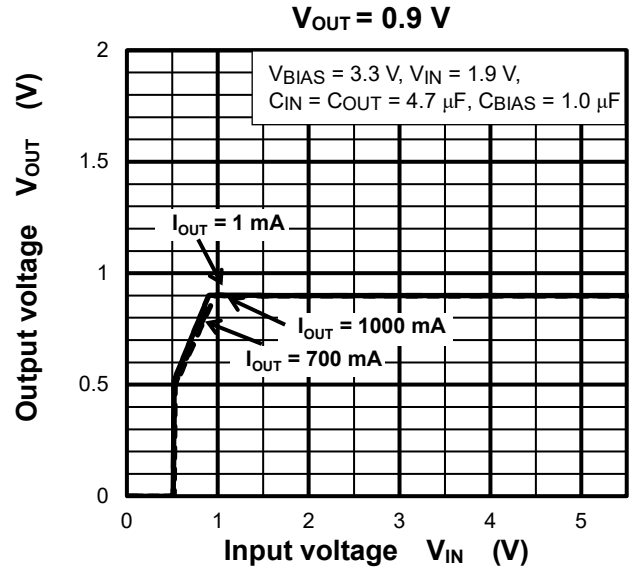
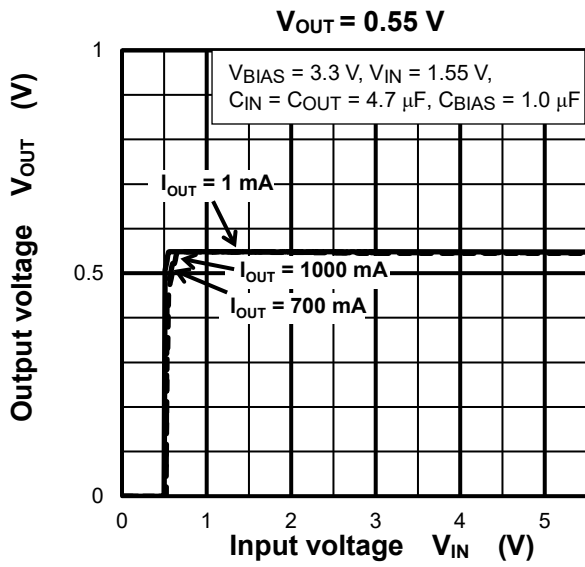

Note: The above characteristics curves are presented for reference only and not guaranteed by production test, unless otherwise noted.

Representative Typical Characteristics

Output voltage vs. Output current

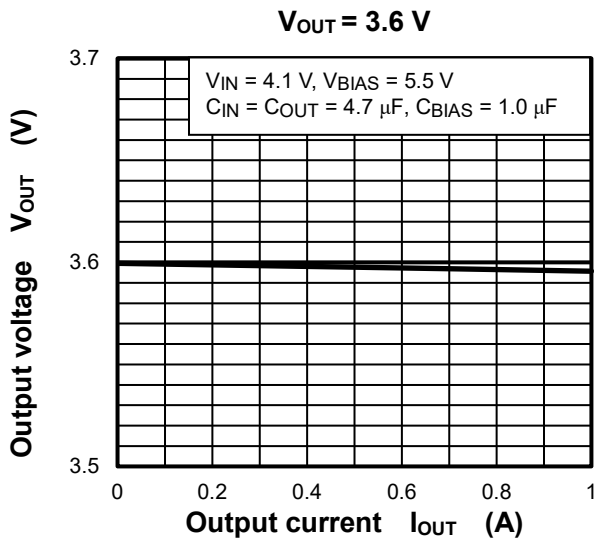
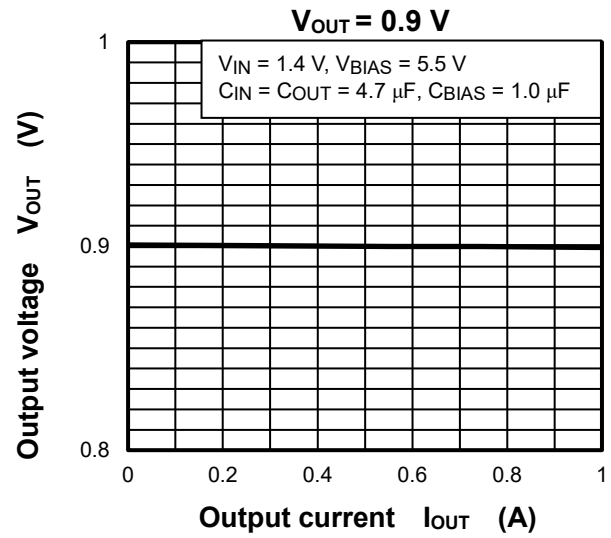
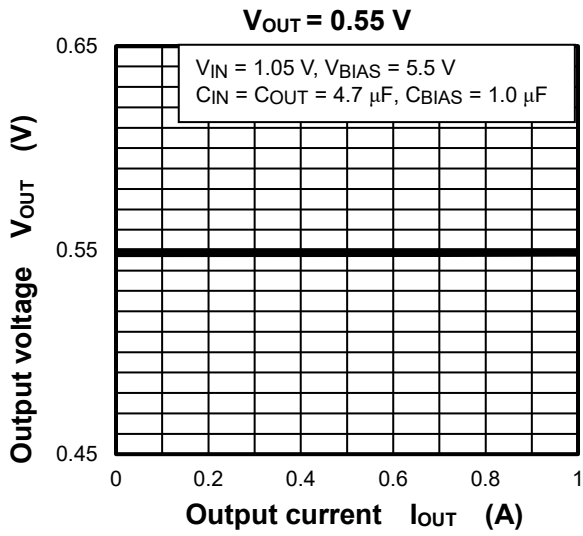

Note: The above characteristics curves are presented for reference only and not guaranteed by production test, unless otherwise noted.

Representative Typical Characteristics

Dropout voltage vs. Output current

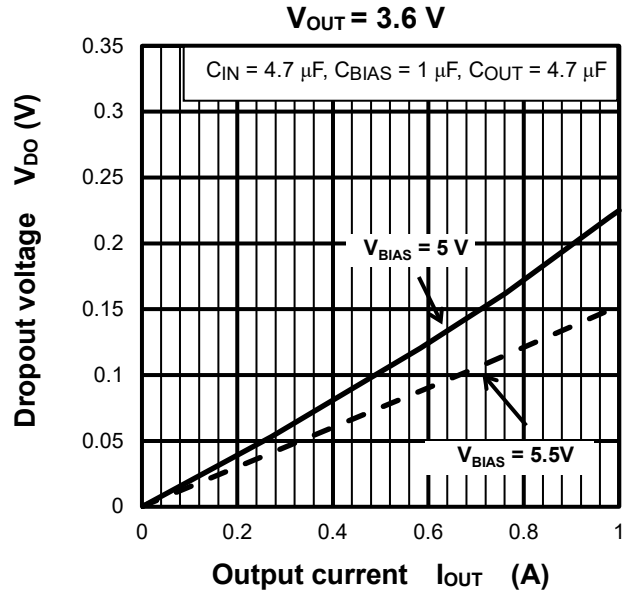
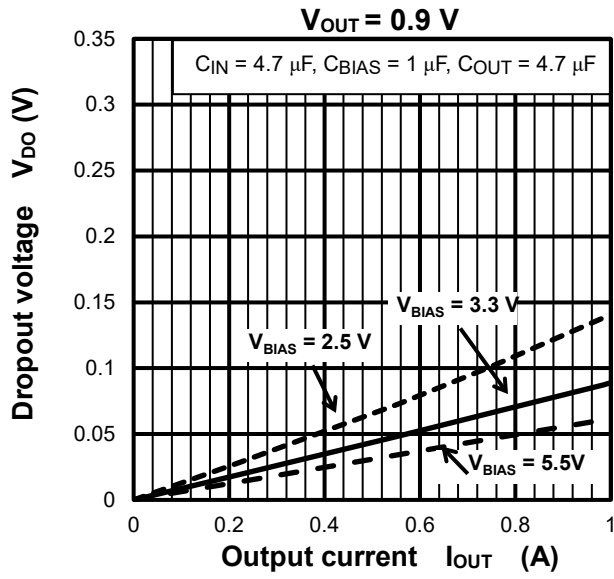

Note: The above characteristics curves are presented for reference only and not guaranteed by production test, unless otherwise noted.

Representative Typical Characteristics

Quiescent current vs. Input voltage

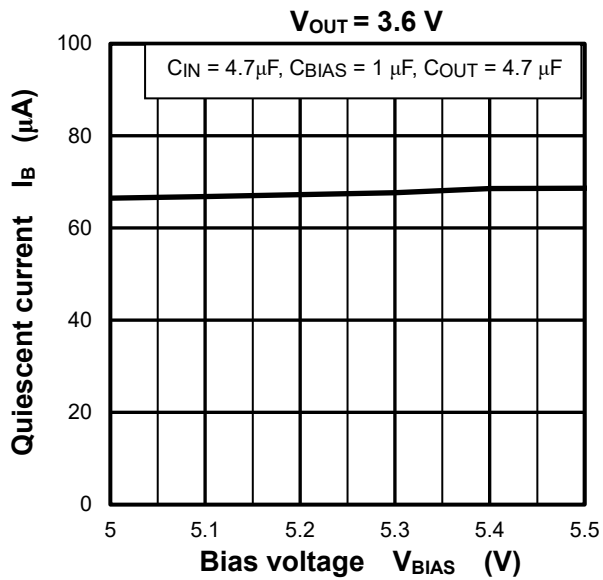
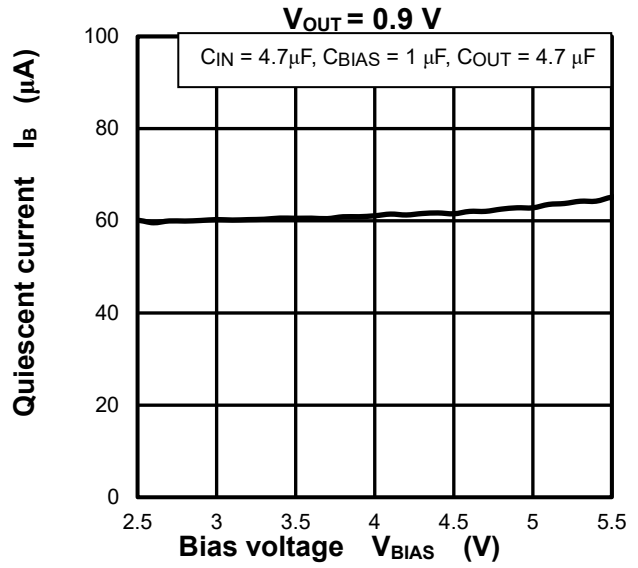
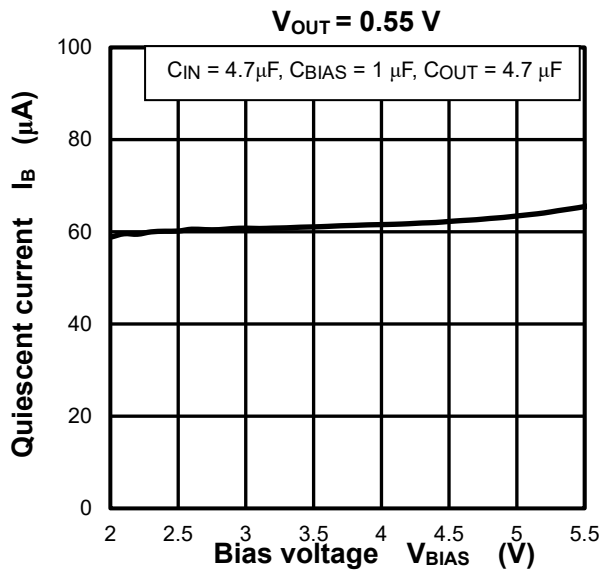

Note: The above characteristics curves are presented for reference only and not guaranteed by production test, unless otherwise noted.

Representative Typical Characteristics

Ripple rejection ratio vs. Frequency

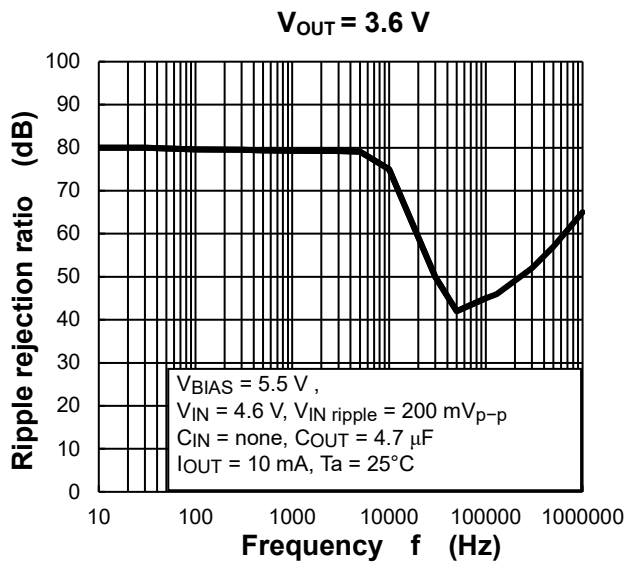
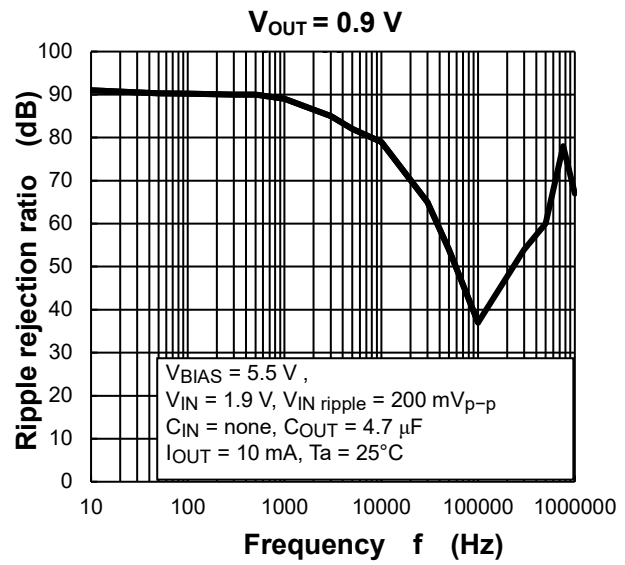
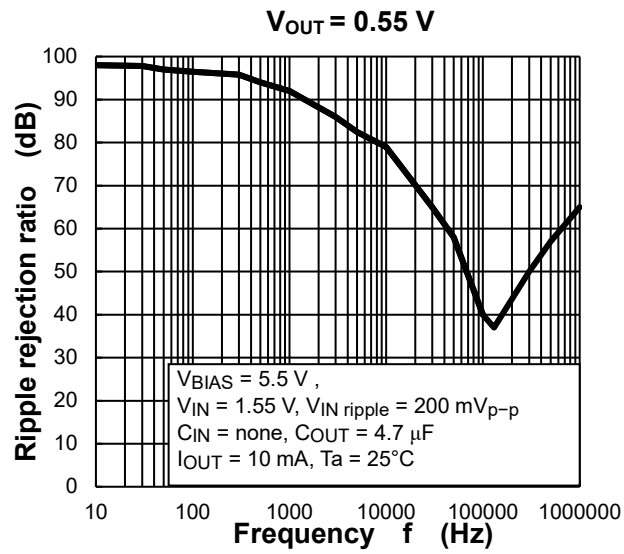

Note: The above characteristics curves are presented for reference only and not guaranteed by production test, unless otherwise noted.

Output voltage vs. Output current (Simulation data)

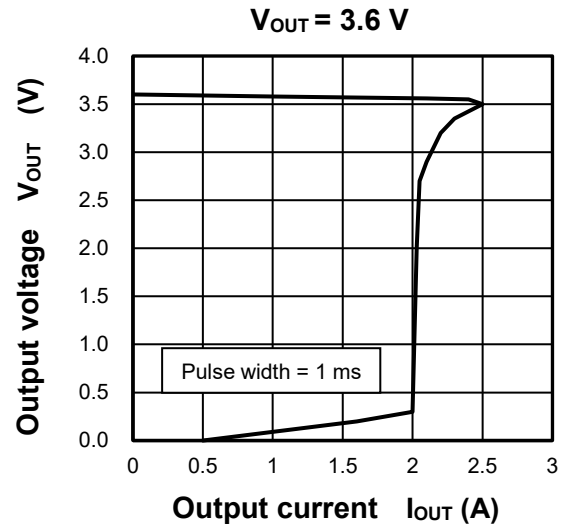
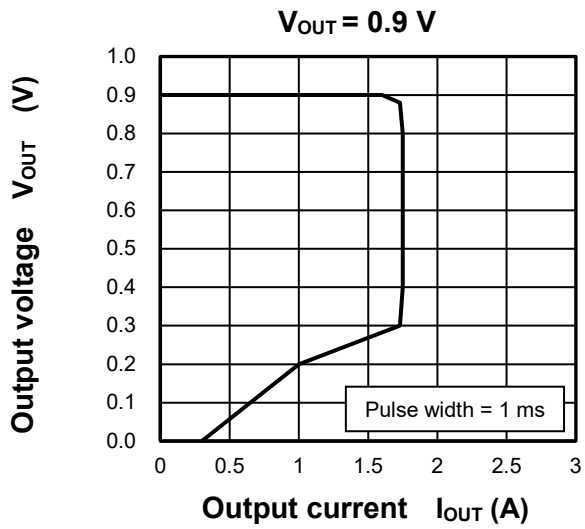

Note: The above characteristics curves are presented for reference only and not guaranteed by production test, unless otherwise noted.

Load transient response

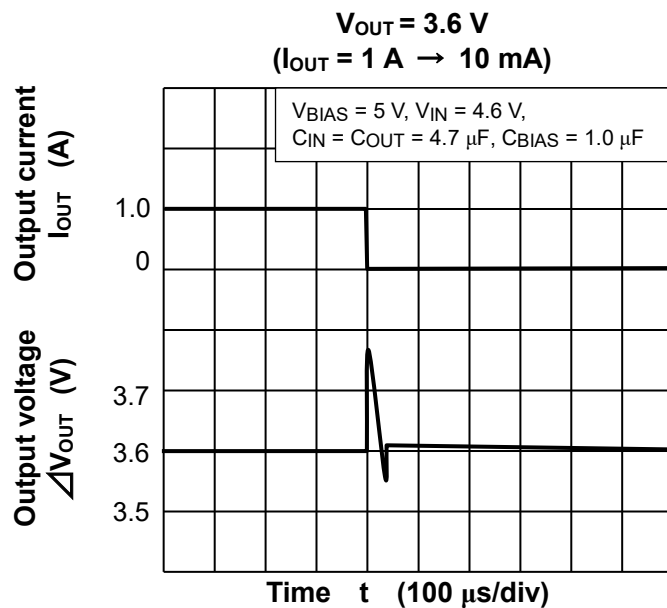
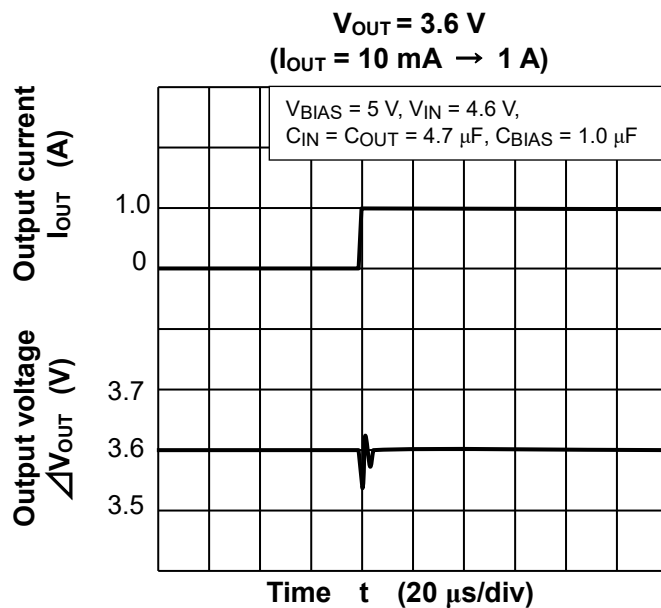
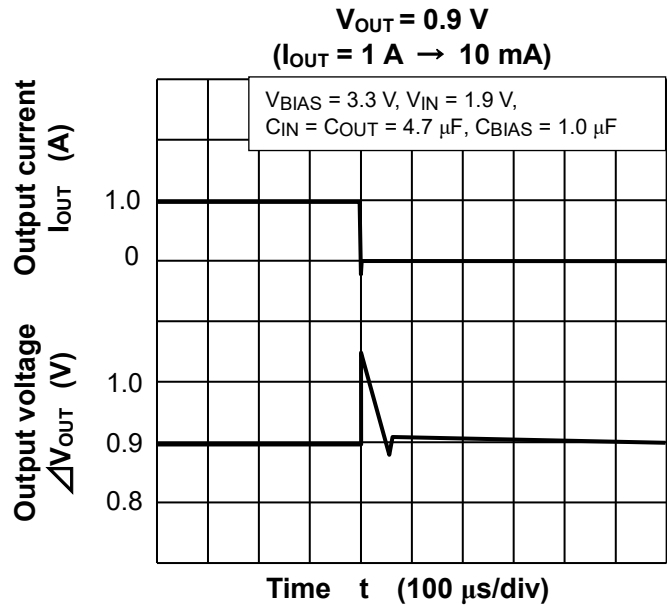
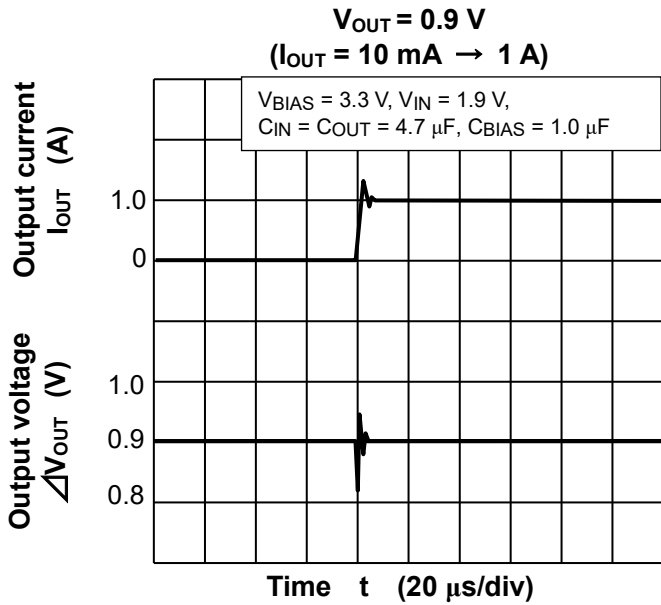

Note: The above characteristics curves are presented for reference only and not guaranteed by production test, unless otherwise noted.

t_{ON} Response

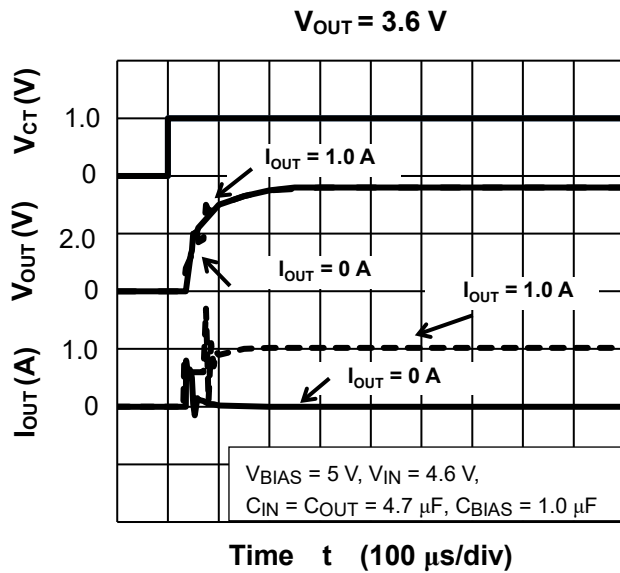
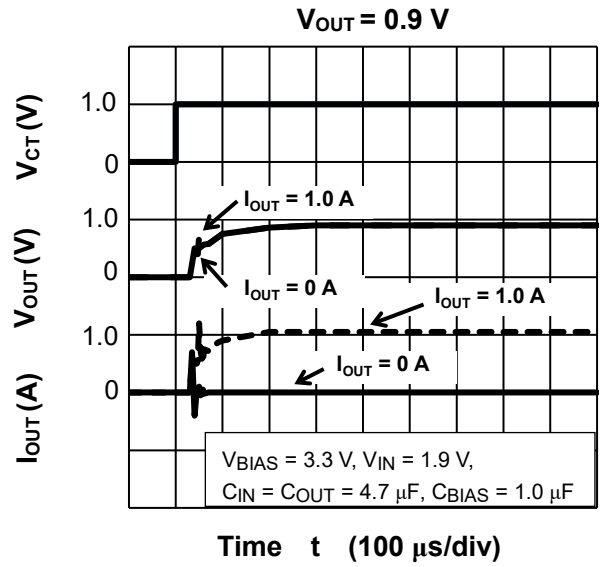
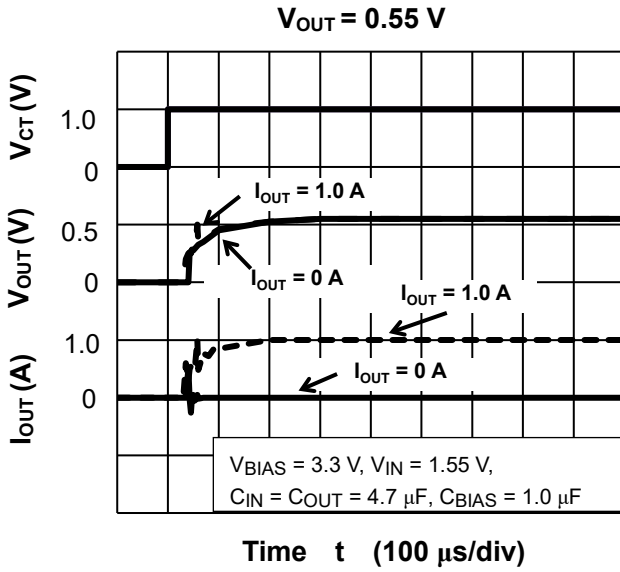

Note: The above characteristics curves are presented for reference only and not guaranteed by production test, unless otherwise noted.

t_{OFF} Response

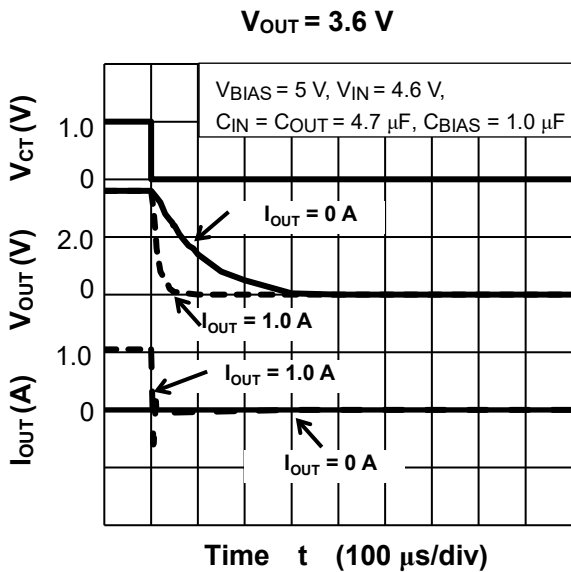
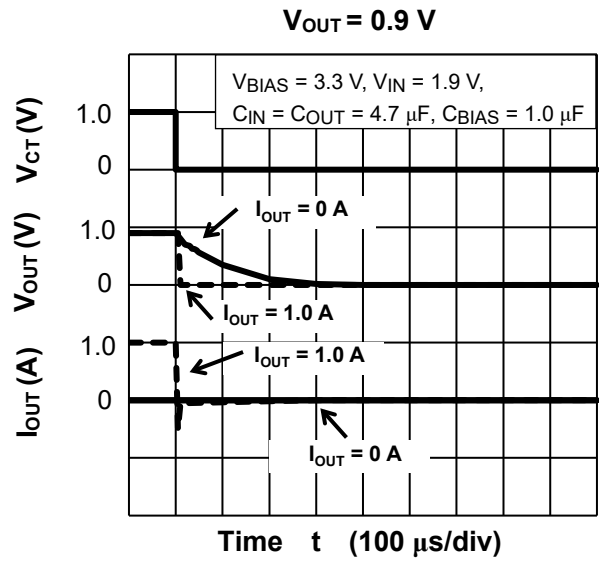
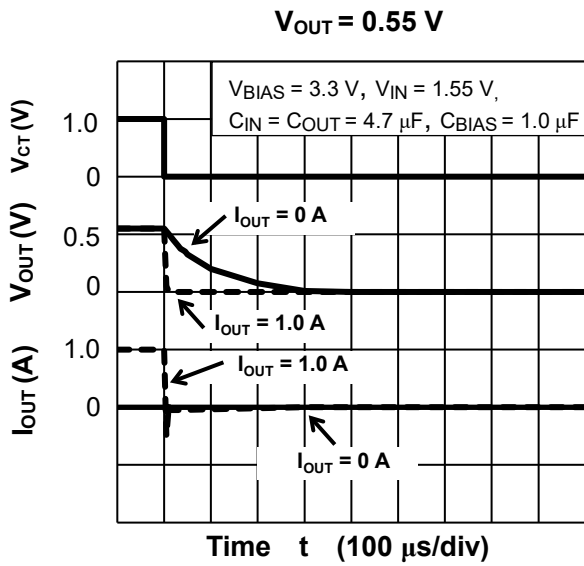

Note: The above characteristics curves are presented for reference only and not guaranteed by production test, unless otherwise noted.

Package Dimensions

WCSP6F

Unit: mm

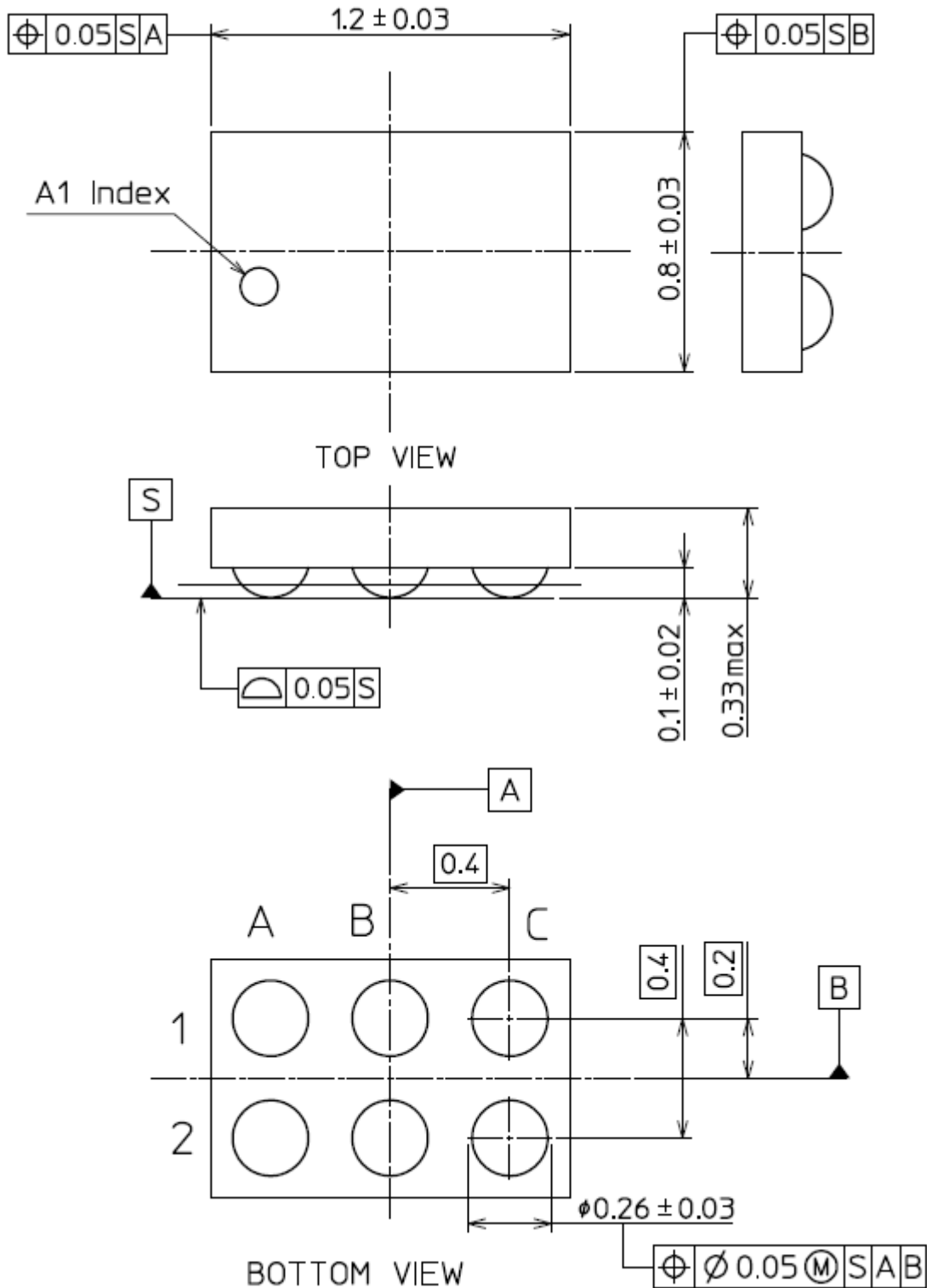

Weight : 0.61 mg (typ.)

Land pattern dimensions for reference only

WCSP6F

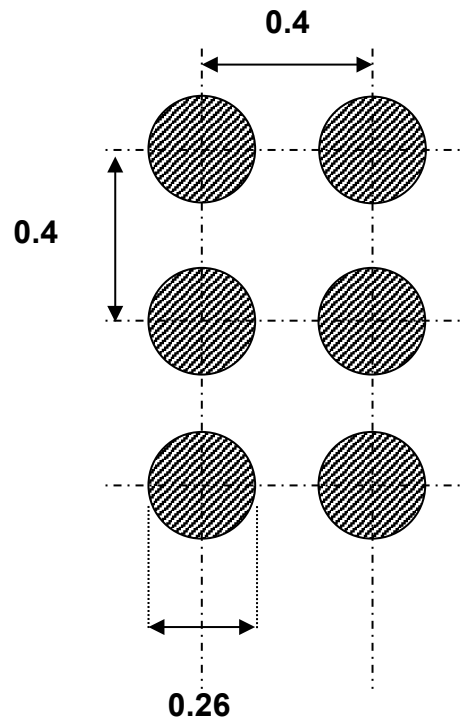

Unit: mm

RESTRICTIONS ON PRODUCT USE

Toshiba Corporation and its subsidiaries and affiliates are collectively referred to as "TOSHIBA". Hardware, software and systems described in this document are collectively referred to as "Product".

- TOSHIBA reserves the right to make changes to the information in this document and related Product without notice.
- This document and any information herein may not be reproduced without prior written permission from TOSHIBA. Even with TOSHIBA's written permission, reproduction is permissible only if reproduction is without alteration/omission.
- Though TOSHIBA works continually to improve Product's quality and reliability, Product can malfunction or fail. Customers are responsible for complying with safety standards and for providing adequate designs and safeguards for their hardware, software and systems which minimize risk and avoid situations in which a malfunction or failure of Product could cause loss of human life, bodily injury or damage to property, including data loss or corruption. Before customers use the Product, create designs including the Product, or incorporate the Product into their own applications, customers must also refer to and comply with (a) the latest versions of all relevant TOSHIBA information, including without limitation, this document, the specifications, the data sheets and application notes for Product and the precautions and conditions set forth in the "TOSHIBA Semiconductor Reliability Handbook" and (b) the instructions for the application with which the Product will be used with or for. Customers are solely responsible for all aspects of their own product design or applications, including but not limited to (a) determining the appropriateness of the use of this Product in such design or applications; (b) evaluating and determining the applicability of any information contained in this document, or in charts, diagrams, programs, algorithms, sample application circuits, or any other referenced documents; and (c) validating all operating parameters for such designs and applications. **TOSHIBA ASSUMES NO LIABILITY FOR CUSTOMERS' PRODUCT DESIGN OR APPLICATIONS.**
- **PRODUCT IS NEITHER INTENDED NOR WARRANTED FOR USE IN EQUIPMENTS OR SYSTEMS THAT REQUIRE EXTRAORDINARILY HIGH LEVELS OF QUALITY AND/OR RELIABILITY, AND/OR A MALFUNCTION OR FAILURE OF WHICH MAY CAUSE LOSS OF HUMAN LIFE, BODILY INJURY, SERIOUS PROPERTY DAMAGE AND/OR SERIOUS PUBLIC IMPACT ("UNINTENDED USE").** Except for specific applications as expressly stated in this document, Unintended Use includes, without limitation, equipment used in nuclear facilities, equipment used in the aerospace industry, lifesaving and/or life supporting medical equipment, equipment used for automobiles, trains, ships and other transportation, traffic signaling equipment, equipment used to control combustions or explosions, safety devices, elevators and escalators, and devices related to power plant. **IF YOU USE PRODUCT FOR UNINTENDED USE, TOSHIBA ASSUMES NO LIABILITY FOR PRODUCT.** For details, please contact your TOSHIBA sales representative or contact us via our website.
- Do not disassemble, analyze, reverse-engineer, alter, modify, translate or copy Product, whether in whole or in part.
- Product shall not be used for or incorporated into any products or systems whose manufacture, use, or sale is prohibited under any applicable laws or regulations.
- The information contained herein is presented only as guidance for Product use. No responsibility is assumed by TOSHIBA for any infringement of patents or any other intellectual property rights of third parties that may result from the use of Product. No license to any intellectual property right is granted by this document, whether express or implied, by estoppel or otherwise.
- **ABSENT A WRITTEN SIGNED AGREEMENT, EXCEPT AS PROVIDED IN THE RELEVANT TERMS AND CONDITIONS OF SALE FOR PRODUCT, AND TO THE MAXIMUM EXTENT ALLOWABLE BY LAW, TOSHIBA (1) ASSUMES NO LIABILITY WHATSOEVER, INCLUDING WITHOUT LIMITATION, INDIRECT, CONSEQUENTIAL, SPECIAL, OR INCIDENTAL DAMAGES OR LOSS, INCLUDING WITHOUT LIMITATION, LOSS OF PROFITS, LOSS OF OPPORTUNITIES, BUSINESS INTERRUPTION AND LOSS OF DATA, AND (2) DISCLAIMS ANY AND ALL EXPRESS OR IMPLIED WARRANTIES AND CONDITIONS RELATED TO SALE, USE OF PRODUCT, OR INFORMATION, INCLUDING WARRANTIES OR CONDITIONS OF MERCHANTABILITY, FITNESS FOR A PARTICULAR PURPOSE, ACCURACY OF INFORMATION, OR NONINFRINGEMENT.**
- Do not use or otherwise make available Product or related software or technology for any military purposes, including without limitation, for the design, development, use, stockpiling or manufacturing of nuclear, chemical, or biological weapons or missile technology products (mass destruction weapons). Product and related software and technology may be controlled under the applicable export laws and regulations including, without limitation, the Japanese Foreign Exchange and Foreign Trade Law and the U.S. Export Administration Regulations. Export and re-export of Product or related software or technology are strictly prohibited except in compliance with all applicable export laws and regulations.
- Please contact your TOSHIBA sales representative for details as to environmental matters such as the RoHS compatibility of Product. Please use Product in compliance with all applicable laws and regulations that regulate the inclusion or use of controlled substances, including without limitation, the EU RoHS Directive. **TOSHIBA ASSUMES NO LIABILITY FOR DAMAGES OR LOSSES OCCURRING AS A RESULT OF NONCOMPLIANCE WITH APPLICABLE LAWS AND REGULATIONS.**

单击下面可查看定价，库存，交付和生命周期等信息

[>>Toshiba\(东芝\)](#)