

## SCHOTTKY BARRIER RECTIFIERS

### PINNING

PIN	DESCRIPTION
1	Cathode
2	Anode

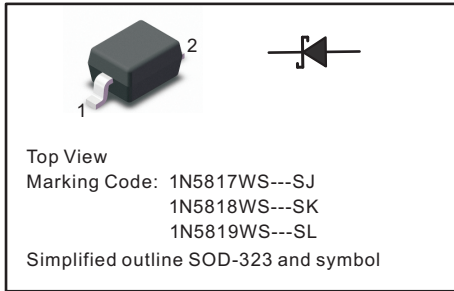

### FEATURES

- ◆ Metal silicon junction, majority carrier conduction
- ◆ Guarding for overvoltage protection
- ◆ Low power loss, high efficiency
- ◆ High current capability
- ◆ low forward voltage drop
- ◆ High surge capability
- ◆ For use in low voltage, high frequency inverters, free wheeling, and polarity protection applications

### MECHANICAL DATA

- ◆ Case: SOD-323
- ◆ Terminals: Solderable per MIL-STD-750, Method 2026
- ◆ Approx. Weight: 5.48mg / 0.00019oz

### Maximum Ratings and Electrical characteristics

Ratings at 25 °C ambient temperature unless otherwise specified.

Parameter	Symbols	1N5817WS	1N5818WS	1N5819WS	Units
Maximum Repetitive Peak Reverse Voltage	$V_{RRM}$	20	30	40	V
Maximum RMS voltage	$V_{RMS}$	14	21	28	V
Maximum DC Blocking Voltage	$V_{DC}$	20	30	40	V
Maximum Average Forward Rectified Current	$I_{F(AV)}$	1			A
Peak Forward Surge Current, 8.3ms Single Half Sine-wave Superimposed On Rated Load (JEDEC method)	$I_{FSM}$	9			A
Maximum Instantaneous Forward Voltage at 1 A at 3 A	$V_F$	0.45 0.75	0.55 0.875	0.6 0.9	V
Maximum Instantaneous Reverse Current at TA = 25°C Rated DC Reverse Voltage TA = 100°C	$I_R$	1 10			mA
Typical Junction Capacitance	$C_j$	110			pF
Storage and Operating Junction Temperature Range	$T_j, T_{stg}$	-55 ~ +150			°C

**Fig.1 Forward Current Derating Curve**

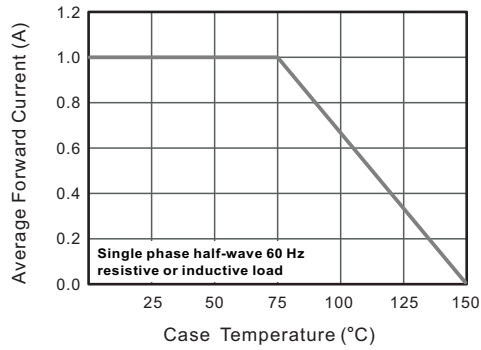

**Fig.2 Typical Reverse Characteristics**

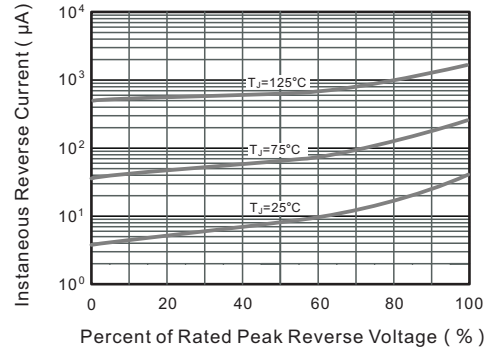

**Fig.3 Typical Forward Characteristic**

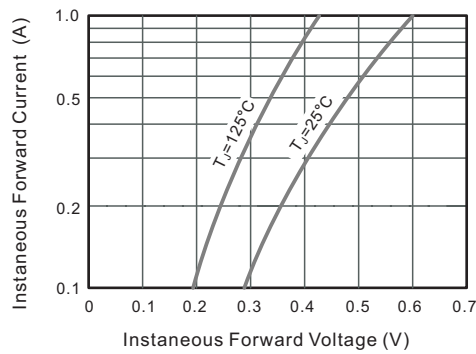

**Fig.4 Typical Junction Capacitance**

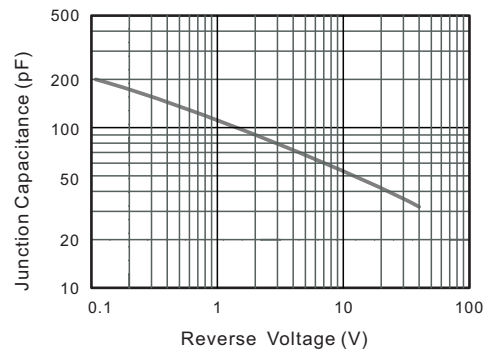

**Fig.5 Maximum Non-Repetitive Peak Forward Surge Current**

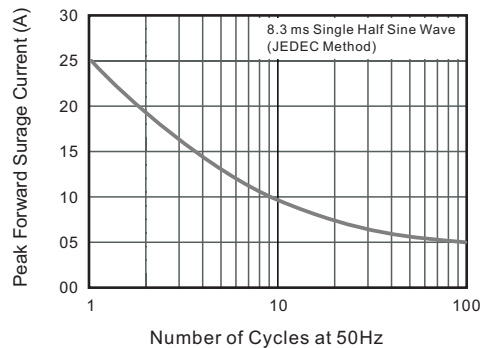

**PACKAGE OUTLINE**

Plastic surface mounted package; 2 leads

SOD-323

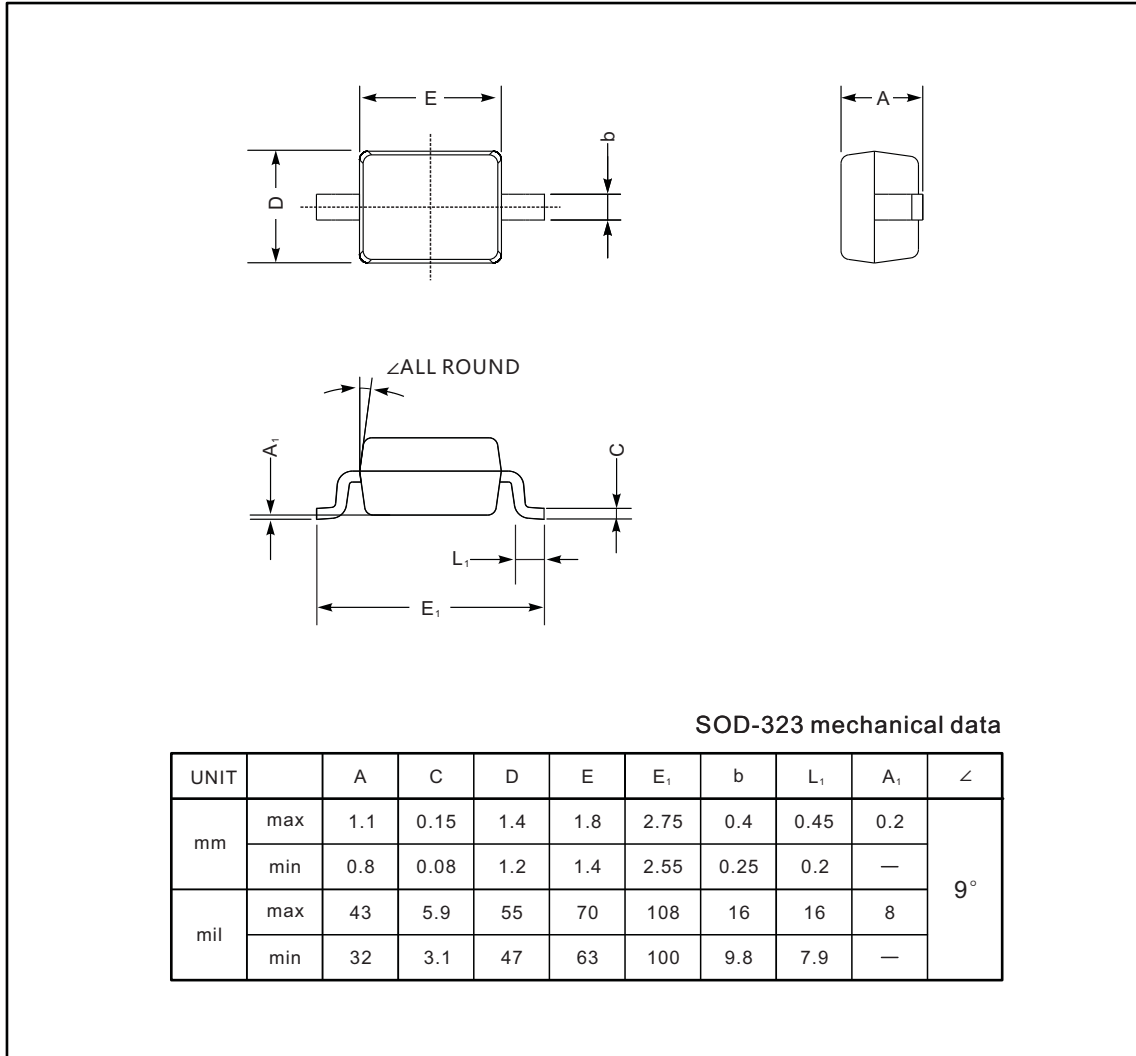

**The recommended mounting pad size**

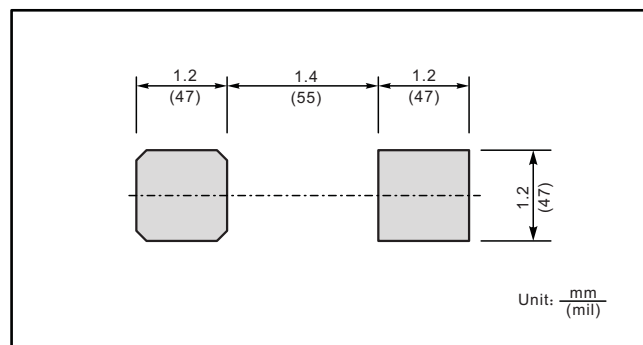

单击下面可查看定价，库存，交付和生命周期等信息

[>>TWGMC\(台湾迪嘉\)](#)