

BCX54 THRU BCX56 TRANSISTOR(NPN)

FEATURE

- PNP Complements to BCX51,BCX52,BCX53
- Low Voltage
- High Current

APPLICATIONS

- Driver Stages of Audio Amplifiers

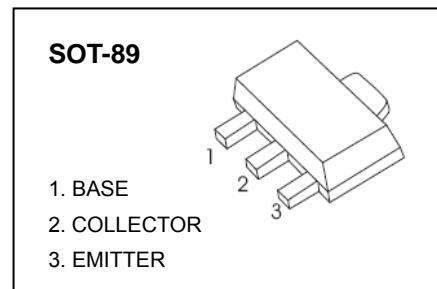

MAXIMUM RATINGS ($T_A=25^{\circ}\text{C}$ unless otherwise noted)

| Symbol | Parameter | Value | Unit |
|-----------------|---|----------|-----------------------------|
| V_{CBO} | Collector-Base Voltage | BCX54 | 45 |
| | | BCX55 | 60 |
| | | BCX56 | 100 |
| V_{CEO} | Collector-Emitter Voltage | BCX54 | 45 |
| | | BCX55 | 60 |
| | | BCX56 | 80 |
| V_{EBO} | Emitter-Base Voltage | 5 | V |
| I_C | Collector Current | 1 | A |
| P_C | Collector Power Dissipation | 500 | mW |
| $R_{\theta JA}$ | Thermal Resistance From Junction To Ambient | 250 | $^{\circ}\text{C}/\text{W}$ |
| T_j | Junction Temperature | 150 | $^{\circ}\text{C}$ |
| T_{stg} | Storage Temperature | -55~+150 | $^{\circ}\text{C}$ |

ELECTRICAL CHARACTERISTICS (Ta=25°C unless otherwise specified)

| Parameter | Symbol | Test conditions | Min | Typ | Max | Unit |
|--------------------------------------|-----------------|---------------------------------|-------|-----|-----|---------|
| Collector-base breakdown voltage | $V_{(BR)CBO}$ | $I_C=100\mu A, I_E=0$ | BCX54 | 45 | | V |
| | | | BCX55 | 60 | | |
| | | | BCX56 | 100 | | |
| Collector-emitter breakdown voltage | $V_{(BR)CEO^*}$ | $I_C=10mA, I_B=0$ | BCX54 | 45 | | V |
| | | | BCX55 | 60 | | |
| | | | BCX56 | 80 | | |
| Emitter-base breakdown voltage | $V_{(BR)EBO}$ | $I_E=100\mu A, I_C=0$ | 5 | | | V |
| Collector cut-off current | I_{CBO} | $V_{CB}=30V, I_E=0$ | | | 0.1 | μA |
| Emitter cut-off current | I_{EBO} | $V_{EB}=5V, I_C=0$ | | | 0.1 | μA |
| DC current gain | $h_{FE(1)^*}$ | $V_{CE}=2V, I_C=5mA$ | 40 | | | |
| | $h_{FE(2)^*}$ | $V_{CE}=2V, I_C=150mA$ | 63 | | 250 | |
| | $h_{FE(3)^*}$ | $V_{CE}=2V, I_C=0.5A$ | 25 | | | |
| Collector-emitter saturation voltage | $V_{CE(sat)^*}$ | $I_C=0.5A, I_B=50mA$ | | | 0.5 | V |
| Base-emitter voltage | V_{BE^*} | $V_{CE}=2V, I_C=0.5A$ | | | 1 | V |
| Transition frequency | f_T | $V_{CE}=5V, I_C=10mA, f=100MHz$ | | 130 | | MHz |

CLASSIFICATION OF $h_{FE(2)}$

| | | | |
|-------|--------------|-----------------|-----------------|
| RANK | BCX54 | BCX54-10 | BCX54-16 |
| | BCX55 | BCX55-10 | BCX55-16 |
| | BCX56 | BCX56-10 | BCX56-16 |
| RANGE | 63 - 250 | 63 - 160 | 100 - 250 |

TYPICAL CHARACTERISTICS

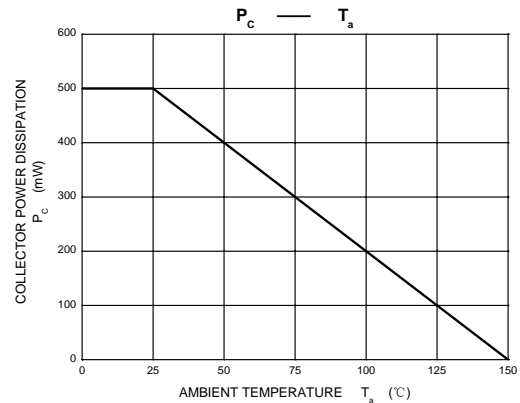
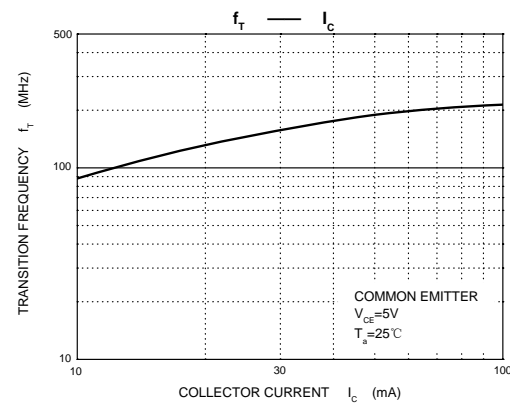
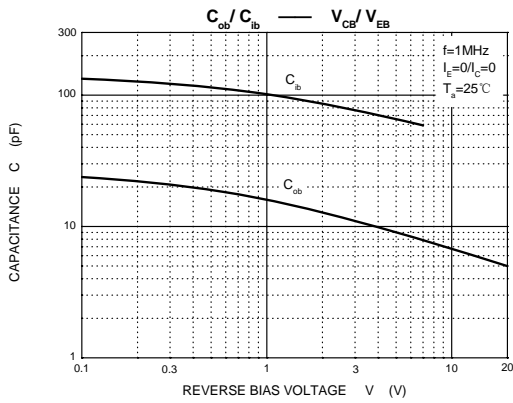
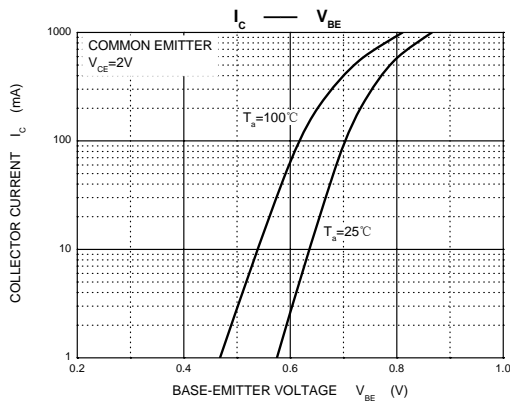
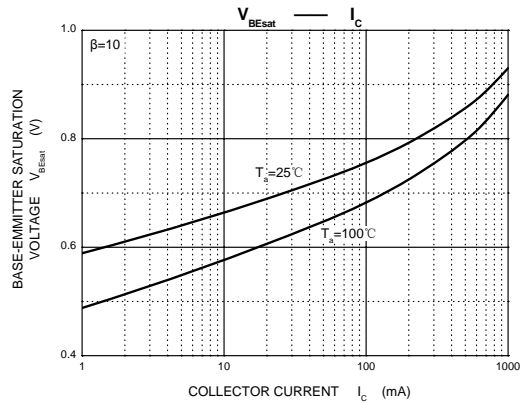
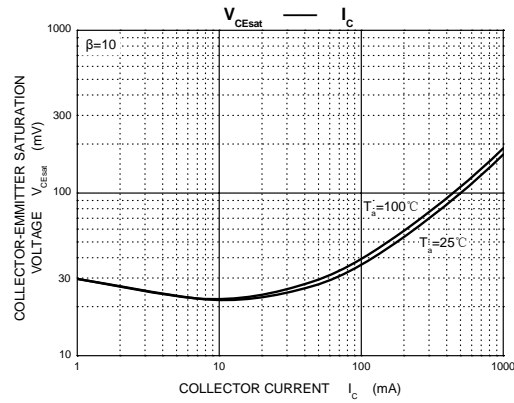
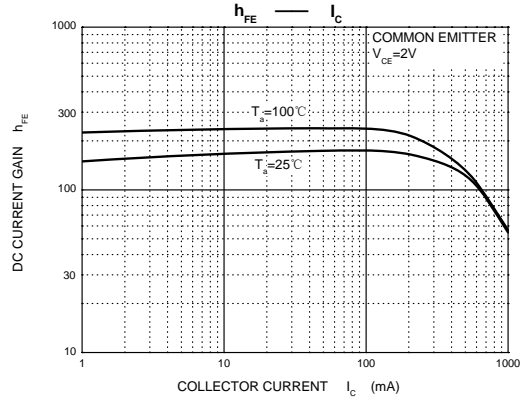
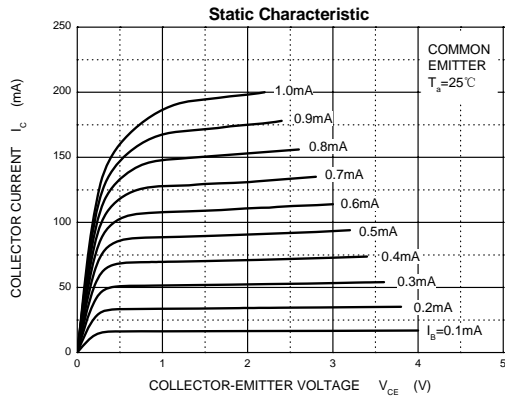

Physical Dimensions

SOT-89

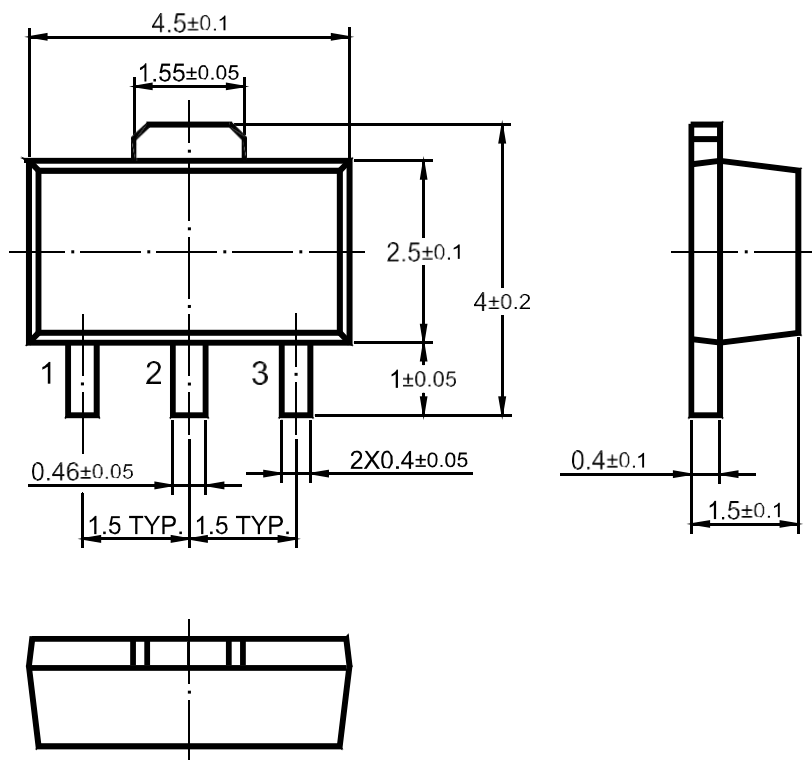

Dimensions in mm

单击下面可查看定价，库存，交付和生命周期等信息

[>>TWGMC\(台湾迪嘉\)](#)