

PNP SILICON EPITAXIAL POWER TRANSISTOR

These devices are intended for use in audio frequency power amplifier and low speed switching applications

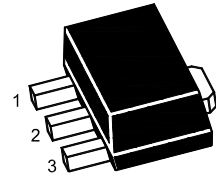

1.Base 2.Collector 3.Emitter
SOT-89 Plastic Package

Absolute Maximum Ratings ($T_a = 25^\circ\text{C}$)

Parameter	Symbol	Value	Unit
Collector Base Voltage	$-V_{CBO}$	40	V
Collector Emitter Voltage	$-V_{CEO}$	30	V
Emitter Base Voltage	$-V_{EBO}$	5	V
Collector Current	$-I_C$	3	A
Peak Collector Current (t = 10 ms)	$-I_{CP}$	7	A
Base Current	$-I_B$	0.6	A
Total Power Dissipation @ $T_a = 25^\circ\text{C}$	P_D	1	W
Total Power Dissipation @ $T_c = 25^\circ\text{C}$	P_D	10	W
Operating and Storage Junction Temperature Range	T_j, T_{stg}	- 65 to + 150	$^\circ\text{C}$

Characteristics at $T_a = 25^\circ\text{C}$

Parameter	Symbol	Min.	Typ.	Max.	Unit
DC Current Gain at $-V_{CE} = 2\text{ V}$, $-I_C = 20\text{ mA}$ at $-V_{CE} = 2\text{ V}$, $-I_C = 1\text{ A}$ Current Gain Group	R	h_{FE}	30	-	-
	Q	h_{FE}	60	-	120
	P	h_{FE}	100	-	200
	E	h_{FE}	160	-	320
	E	h_{FE}	200	-	400
Collector Base Cutoff Current at $-V_{CB} = 30\text{ V}$	$-I_{CBO}$	-	-	1	μA
Emitter Base Cutoff Current at $-V_{EB} = 3\text{ V}$	$-I_{EBO}$	-	-	1	μA
Collector Base Breakdown Voltage at $-I_C = 1\text{ mA}$	$-V_{(BR)CBO}$	40	-	-	V
Collector Emitter Breakdown Voltage at $-I_C = 1\text{ mA}$	$-V_{(BR)CEO}$	30	-	-	V
Emitter Base Breakdown Voltage at $-I_E = 1\text{ mA}$	$-V_{(BR)EBO}$	5	-	-	V
Collector Emitter Saturation Voltage at $-I_C = 2\text{ A}$, $-I_B = 200\text{ mA}$	$-V_{CE(sat)}$	-	-	0.5	V
Base Emitter Saturation Voltage at $-I_C = 2\text{ A}$, $-I_B = 200\text{ mA}$	$-V_{BE(sat)}$	-	-	2	V
Current Gain Bandwidth Product at $-V_{CE} = 5\text{ V}$, $-I_C = 100\text{ mA}$,	f_T	-	80	-	MHz
Output Capacitance at $-V_{CB} = 10\text{ V}$, $f = 1\text{ MHz}$	C_{ob}	-	55	-	pF

Static Characteristic

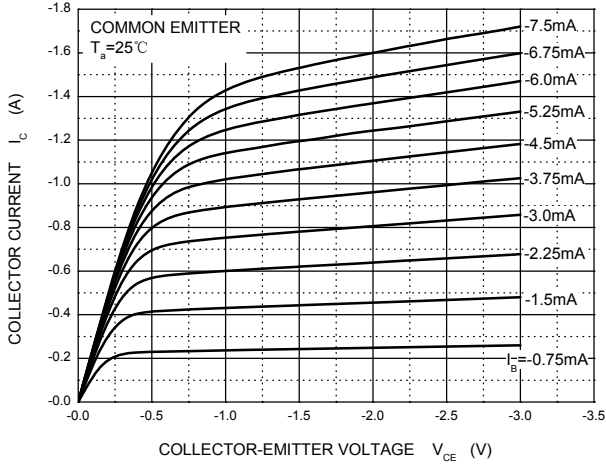

$h_{FE} - I_c$

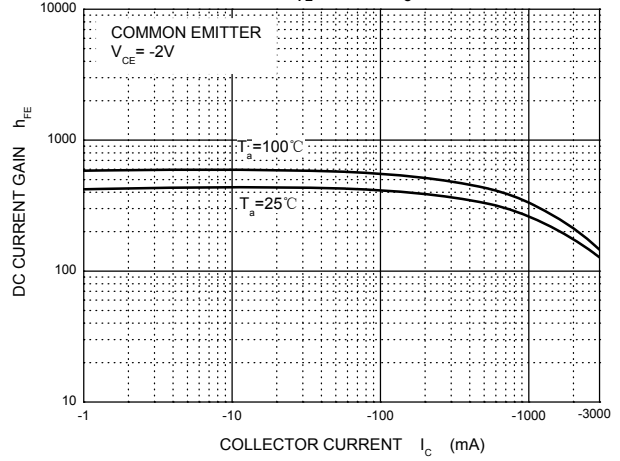

$V_{CEsat} - I_c$

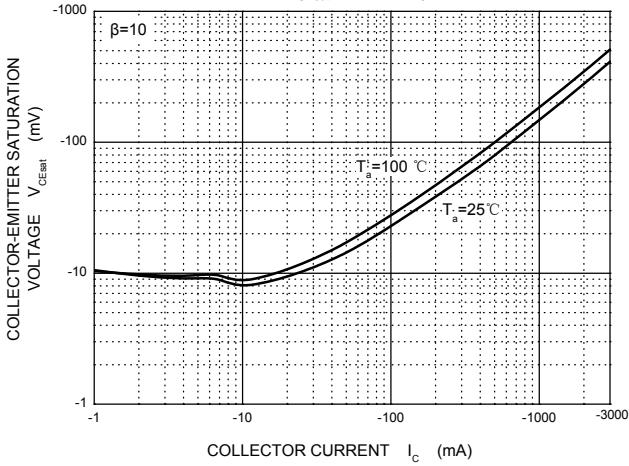

$V_{BEsat} - I_c$

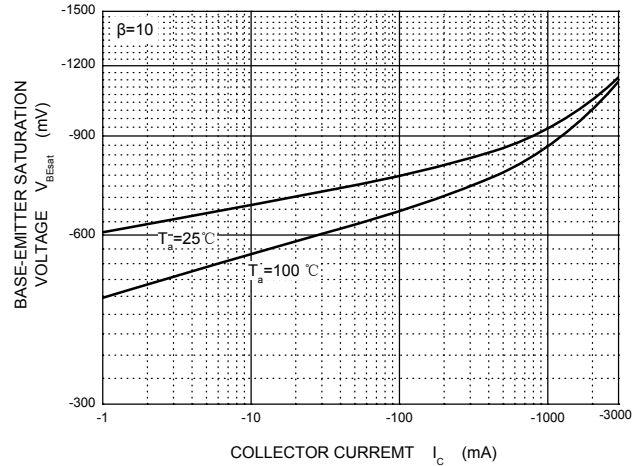

$I_c - V_{BE}$

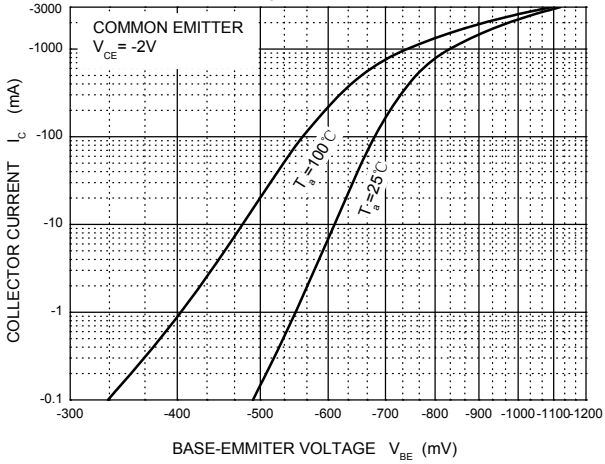

$f_T - I_c$

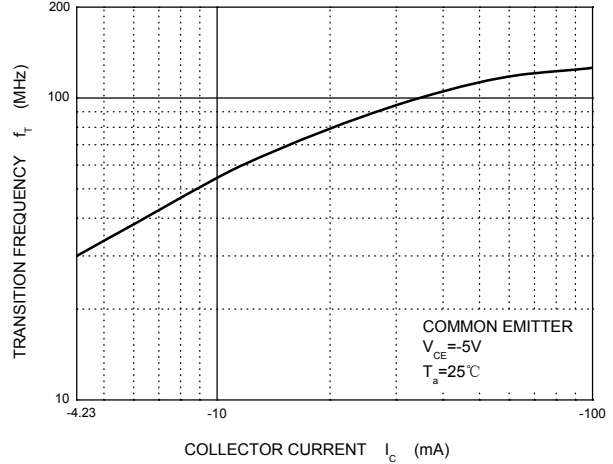

$P_c - T_a$

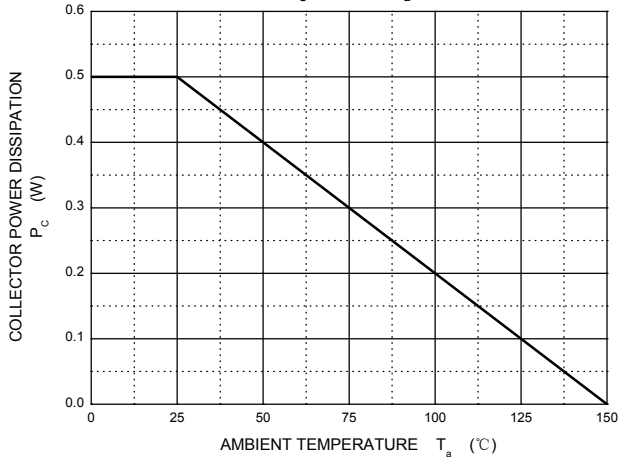

SOT-89 PACKAGE OUTLINE

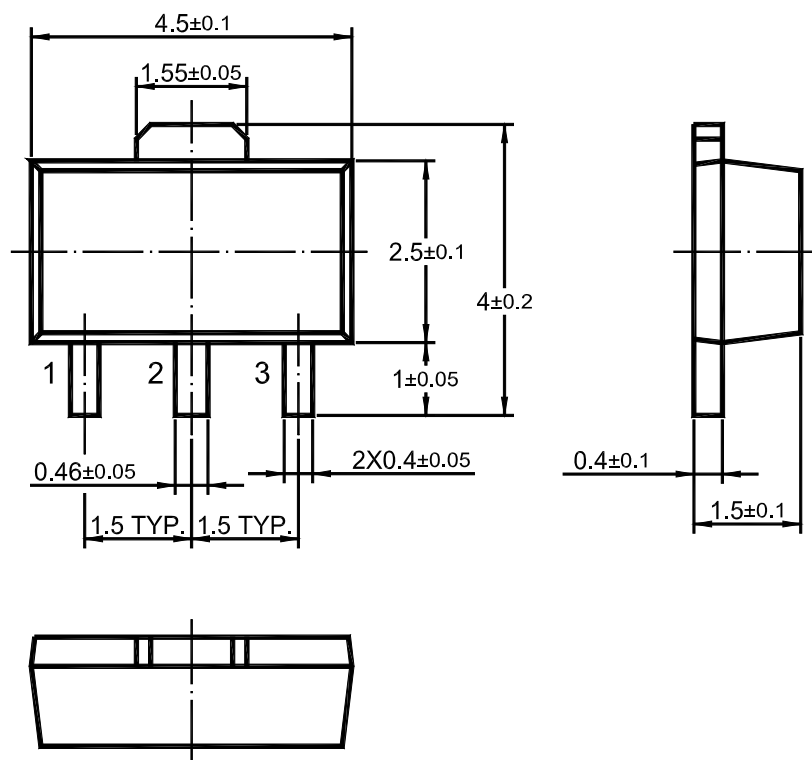

Dimensions in mm

单击下面可查看定价，库存，交付和生命周期等信息

[>>TWGMC\(台湾迪嘉\)](#)