

MMBT3906M TRANSISTOR (PNP)

FEATURE

- Complementary to MMBT3904M
- Small Package

MARKING: 3N

MAXIMUM RATINGS ($T_a=25^\circ\text{C}$ unless otherwise noted)

Symbol	Parameter	Value	Unit
V_{CB0}	Collector-Base Voltage	-40	V
V_{CE0}	Collector-Emitter Voltage	-40	V
V_{EB0}	Emitter-Base Voltage	-5	V
I_c	Collector Current -Continuous	-0.2	A
P_c	Power Dissipation	100	mW
$R_{\theta JA}$	Thermal Resistance from Junction to Ambient	1250	$^\circ\text{C/W}$
T_J, T_{stg}	Operation Junction and Storage Temperature Range	-55~+150	$^\circ\text{C}$

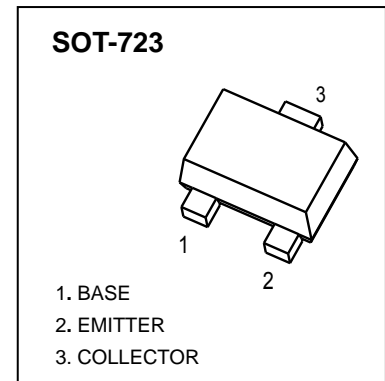

ELECTRICAL CHARACTERISTICS ($T_a=25^\circ\text{C}$ unless otherwise specified)

Parameter	Symbol	Test conditions	Min	Typ	Max	Unit
Collector-base breakdown voltage	$V_{(BR)CBO}$	$I_c=-10\mu\text{A}, I_E=0$	-40			V
Collector-emitter breakdown voltage	$V_{(BR)CEO}$	$I_c=-1\text{mA}, I_B=0$	-40			V
Emitter-base breakdown voltage	$V_{(BR)EBO}$	$I_E=-10\mu\text{A}, I_c=0$	-5			V
Collector cut-off current	I_{CBO}	$V_{CB}=-40\text{V}, I_E=0$			-100	nA
Collector cut-off current	I_{CEX}	$V_{CE}=-30\text{V}, V_{BE(off)}=-3\text{V}$			-50	nA
Emitter cut-off current	I_{EBO}	$V_{EB}=-5\text{V}, I_c=0$			-100	nA
DC current gain	$h_{FE(1)}$	$V_{CE}=-1\text{V}, I_c=-10\text{mA}$	100		300	
	$h_{FE(2)}$	$V_{CE}=-1\text{V}, I_c=-50\text{mA}$	60			
	$h_{FE(3)}$	$V_{CE}=-2\text{V}, I_c=-100\text{mA}$	30			
Collector-emitter saturation voltage	$V_{CE(sat)}$	$I_c=-50\text{mA}, I_B=-5\text{mA}$			-0.3	V
Base-emitter saturation voltage	$V_{BE(sat)}$	$I_c=-50\text{mA}, I_B=-5\text{mA}$			-0.95	V
Transition frequency	f_T	$V_{CE}=-20\text{V}, I_c=-10\text{mA}, f=100\text{MHz}$	300			MHz
Delay time	t_d	$V_{CC}=-3\text{V}, V_{BE(off)}=-0.5\text{V}, I_c=-10\text{mA}, I_{B1}=I_{B2}=-1\text{mA}$			35	ns
Rise time	t_r				35	ns
Storage time	t_s	$V_{CC}=-3\text{V}, I_c=-10\text{mA}, I_{B1}=I_{B2}=-1\text{mA}$			225	ns
Fall time	t_f				75	ns

Typical Characteristics

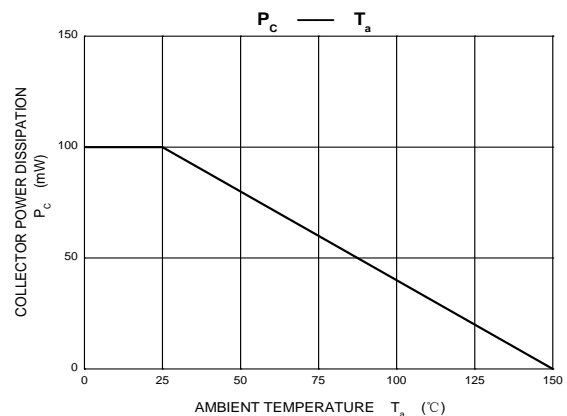
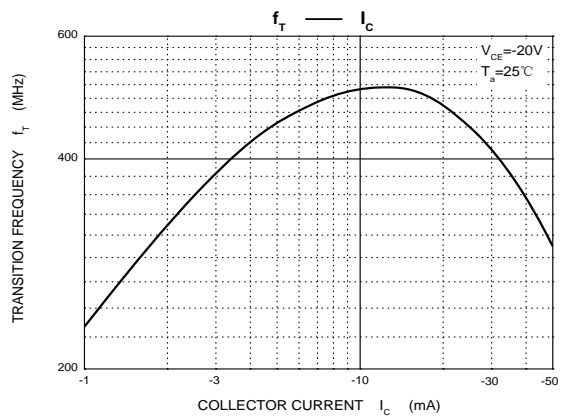
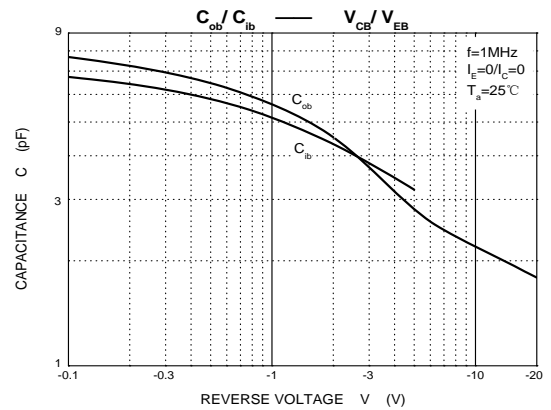
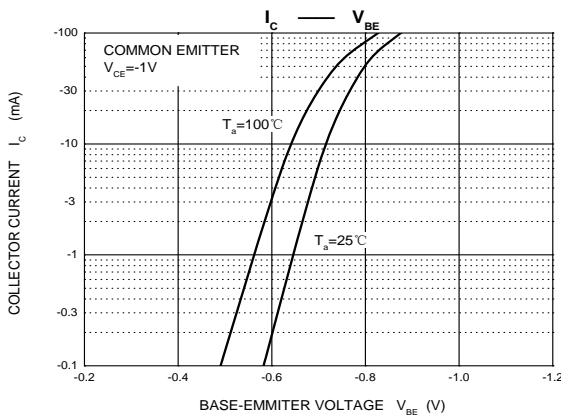
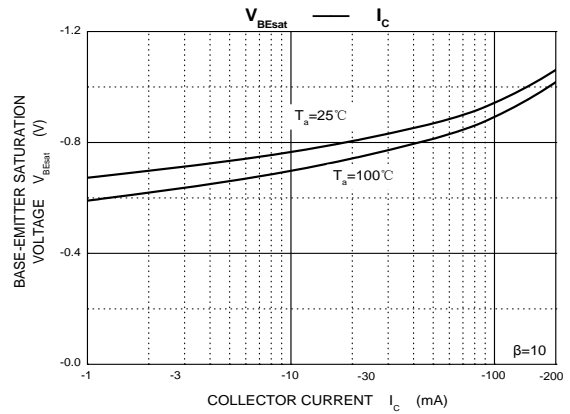
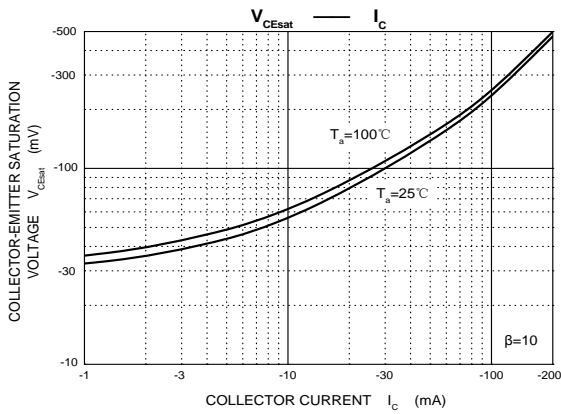
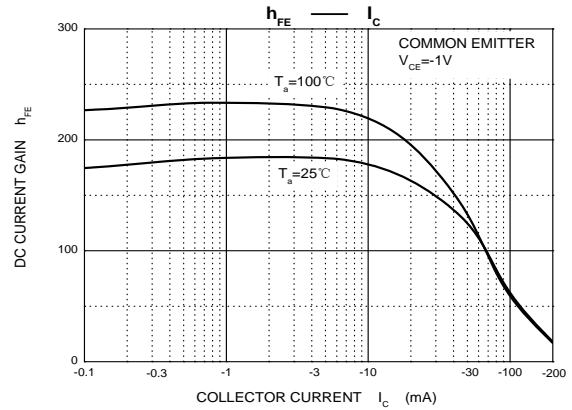
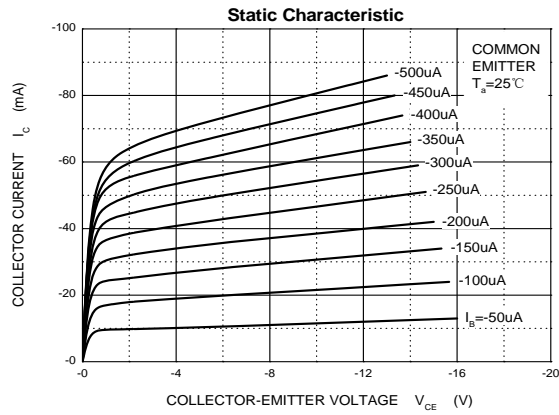

SOT-723 Package Outline Dimensions

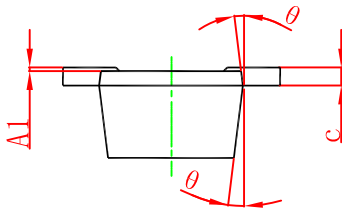
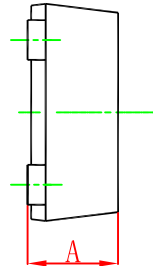
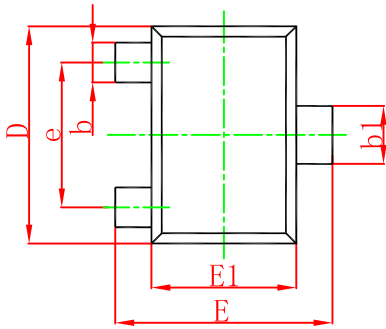

Symbol	Dimensions In Millimeters		Dimensions In Inches	
	Min.	Max.	Min.	Max.
A	0.430	0.500	0.017	0.020
A1	0.000	0.050	0.000	0.002
b	0.170	0.270	0.007	0.011
b1	0.270	0.370	0.011	0.015
c	0.080	0.150	0.003	0.006
D	1.150	1.250	0.045	0.049
E	1.150	1.250	0.045	0.049
E1	0.750	0.850	0.030	0.033
e	0.800TYP.		0.031TYP.	
θ	7° REF.		7° REF.	

SOT-723 Suggested Pad Layout

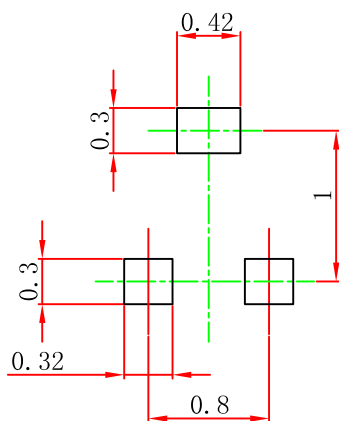

- Note:
1. Controlling dimension: in millimeters.
 2. General tolerance: $\pm 0.05\text{mm}$.
 3. The pad layout is for reference purposes only.

单击下面可查看定价，库存，交付和生命周期等信息

[>>TWGMC\(台湾迪嘉\)](#)