

4-CHANNEL LOW CAPACITANCE ESD PROTECTION DIODES ARRAY

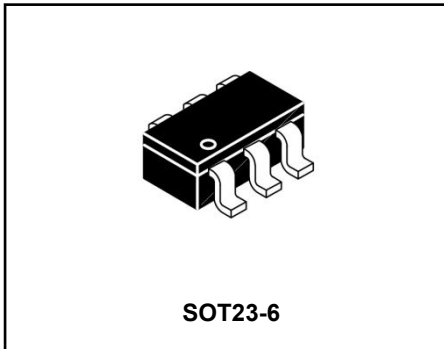

Features

- ◆ 6 inch advanced semiconductor technology
- ◆ Response time is typically < 1 ns
- ◆ Ultra low leakage: nA level
- ◆ Low clamping voltage
- ◆ Molding compound flammability rating: UL 94V-0
- ◆ Lead finish: lead free
- ◆ SOT-23-6 package

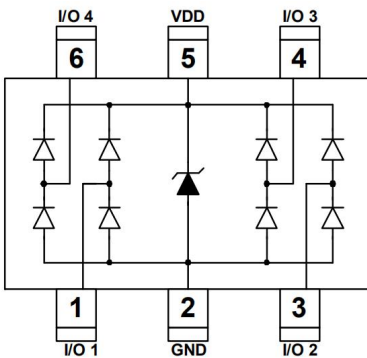

Pin Configuration

Applications

- ◆ ESD and surge protection of power lines
- ◆ ESD and surge protection of signal lines (main application)
- ◆ Other abnormal interference protection

Electronics parameter

Symbol	Parameter
V_{RWM}	Peak reverse working voltage
I_R	Reverse leakage current @ V_{RWM}
V_{BR}	Breakdown voltage @ I_T
I_T	Test current
I_{PP}	Maximum reverse peak pulse current
V_C	Clamping voltage @ I_{PP}

V-I curve

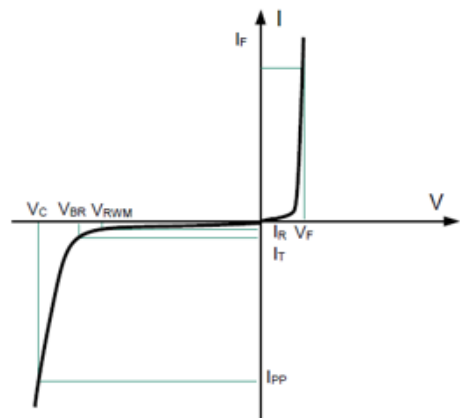

Absolute maximum ratings ($T_A=25^\circ\text{C}$ unless otherwise specified)

Parameter	Symbol	Value	Unit
IEC 61000-4-2 (ESD)(Air)	V_{ESD}	± 20	KV
IEC 61000-4-2 (ESD)(Contact)	V_{ESD}	± 15	KV
IEC 61000-4-4 (EFT)(5/50ns)	I_{PP}	40	A
Peak pulse current (8/20us) ^① , I/O-GND	I_{PP}	4	A
Peak pulse current (8/20us), I/O-I/O	I_{PP}	4	A
Peak pulse current (8/20us), V_{CC} -GND	I_{PP}	17	A
Peak pulse power (8/20us), I/O-GND	P_{PP}	56	W
Peak pulse power (8/20us), I/O-I/O	P_{PP}	92	W
Peak pulse power (8/20us), V_{CC} -GND	P_{PP}	306	W
Operating temperature range	T_J	-40 to +125	$^\circ\text{C}$
Storage temperature range	T_{stg}	-55 to +150	$^\circ\text{C}$

①, 8/20us: IEC61000-4-5 surge compliant, same as the full datasheet

Electrical characteristics ($T_A=25^\circ\text{C}$ unless otherwise specified)

Parameter	Symbol	Test condition	Min	Typ	Max	Unit
Reverse working voltage	V_{RWM}				5	V
Breakdown voltage	V_{BR}	$I_T = 1\text{mA}$, I/O-GND	6	7.3	8.5	V
Breakdown voltage	V_{BR}	$I_T = 1\text{mA}$, I/O-I/O	7	8.3	9.5	V
Breakdown voltage	V_{BR}	$I_T = 1\text{mA}$, V_{CC} -GND	6	7	8	V
Reverse leakage current	I_{R}	$V_{\text{RWM}} = 5\text{V}$		<5	100	nA
Clamping voltage	V_{C}	$I_{\text{PP}} = 1\text{A}$ (8 / 20 μs), I/O-GND		8	12	V
Clamping voltage	V_{C}	$I_{\text{PP}} = 4\text{A}$ (8 / 20 μs), I/O-GND		11	14	V
Clamping voltage	V_{C}	$I_{\text{PP}} = 1\text{A}$ (8 / 20 μs), I/O-I/O		10	14	V
Clamping voltage	V_{C}	$I_{\text{PP}} = 4\text{A}$ (8 / 20 μs), I/O-I/O		19	23	V
Clamping voltage	V_{C}	$I_{\text{PP}} = 1\text{A}$ (8 / 20 μs), V_{CC} -GND		7.5	9	V
Clamping voltage	V_{C}	$I_{\text{PP}} = 17\text{A}$ (8 / 20 μs), V_{CC} -GND		12.5	18	V
Junction capacitance	C_J	$V_{\text{R}} = 0\text{V}$, $f = 1\text{MHz}$, I/O-GND		0.6	0.8	pF
Junction capacitance	C_J	$V_{\text{R}} = 0\text{V}$, $f = 1\text{MHz}$, I/O-I/O		0.3	0.4	pF
Junction capacitance	C_J	$V_{\text{R}} = 0\text{V}$, $f = 1\text{MHz}$, V_{CC} -GND		140	250	pF

Typical performance characteristics ($T_A=25^\circ\text{C}$ unless otherwise specified)

IEC61000-4-2 ESD waveform

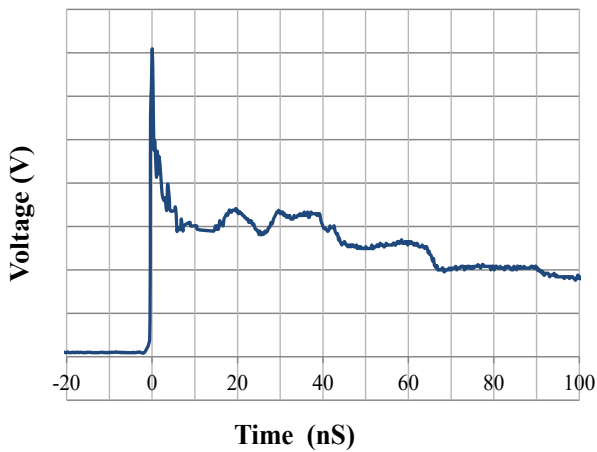

IEC61000-4-5 8/20us waveform

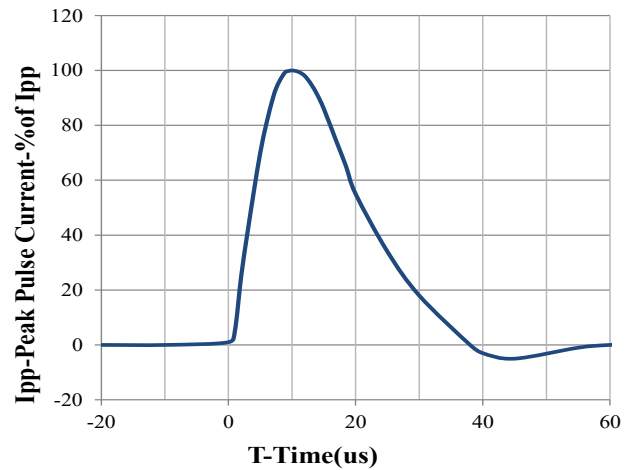

$P_{PP} - T_a$ curve

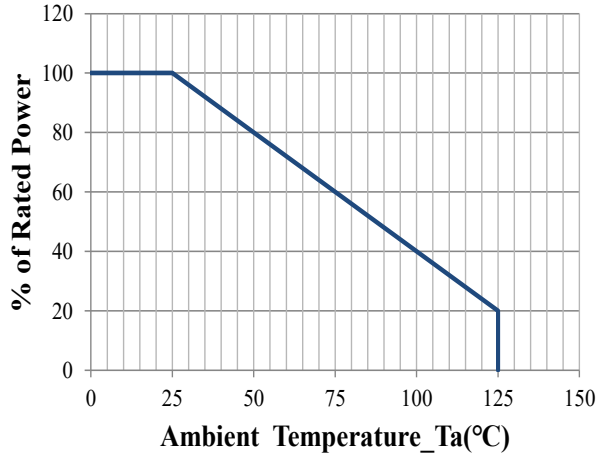

SOT23-6 Package outline

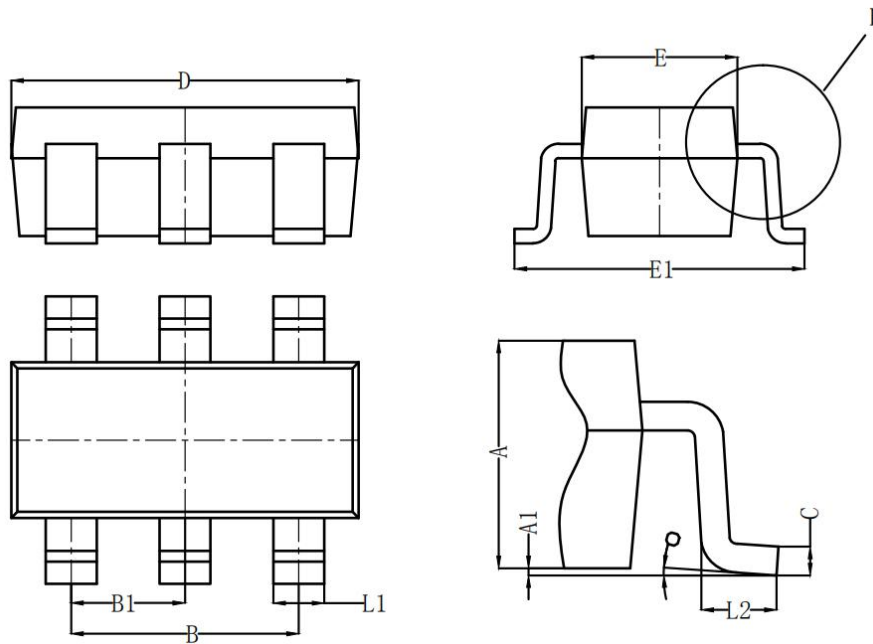

Symbol	Dimensions (mm)		
	Min	Typ	Max
A	1.050	1.100	1.150
A1	0.000	0.050	0.100
L1	0.300	0.400	0.500
C	0.100	0.150	0.200
D	2.820	2.920	3.020
E	1.500	1.600	1.700
E1	2.650	2.800	2.950
B	1.800	1.900	2.000
B1	0.950 Typ		
L2	0.300	0.450	0.600
O	0°	4°	8°

Soldering parameters

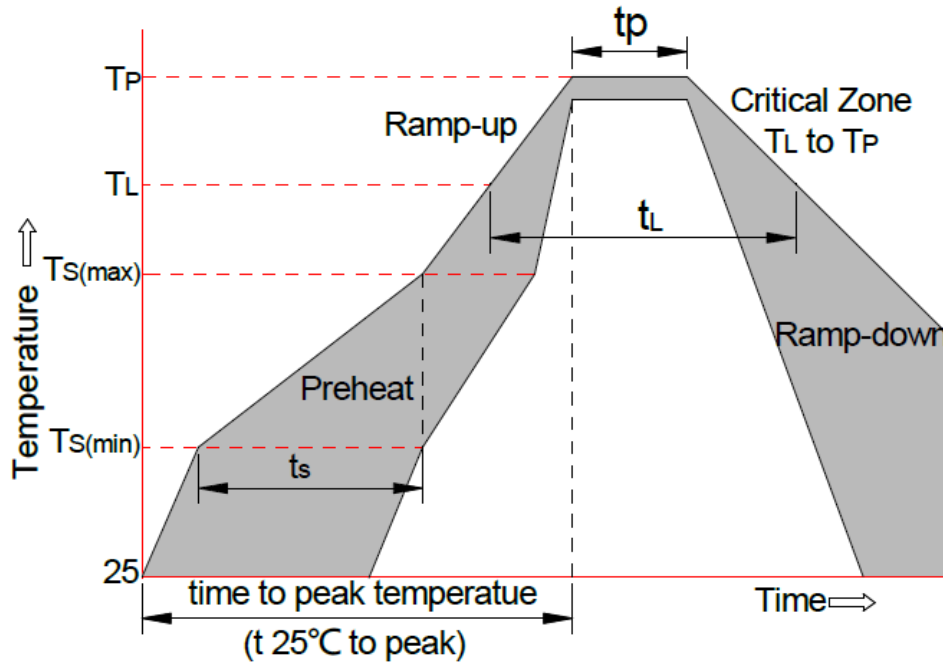

Reflow condition		Pb-free assembly
Pre-heat	-Temperature min (T_S (min))	+150°C
	-Temperature max (T_S (max))	+200°C
	-Time (min to max) (t_s)	60-180 secs.
Average ramp up rate (Liquid us temp (T_L) to peak)		3°C/sec. max
T_S (max) to T_L -Ramp-up Rate		3°C/sec. max
Reflow	-Temperature (T_L) (Liquidus)	+217°C
	-Temperature (T_L)	60-150 secs.
Peak temp (T_P)	Peak temp (T_P)	+260(+0/-5)°C
Time within 5°C of actual peak temp (t_p)	Time within 5°C of actual peak temp (t_p)	20-40 secs.
Ramp-down rate	Ramp-down rate	6 °C/secs. max
Time 25°C to peak temp (TP)	Time 25°C to peak temp (T_P)	8 min. max
Do not exceed	Do not exceed	+260°C

单击下面可查看定价，库存，交付和生命周期等信息

[>>TWGMC\(台湾迪嘉\)](#)