

NPN Silicon Epitaxial Planar Digital Transistor

FEATURES

- Built-in bias resistors enable the configuration of an inverter circuit without connecting external input resistors(see equivalent circuit)
- The bias resistors consist of thin-film resistors with complete isolation to allow negative biasing of the input. They also have the advantage of almost completely eliminating parasitic effects
- Only the on/off conditions need to be set for operation, making device designs easy

Equivalent Circuit

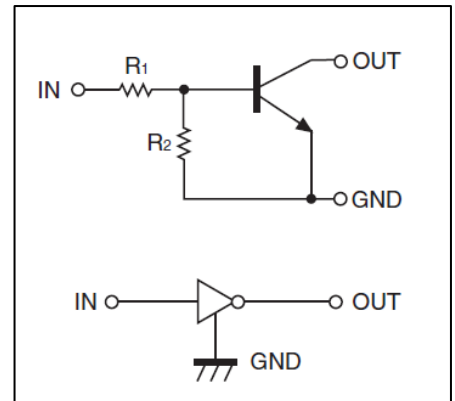

MARKING: 24

PIN CONNECTIONS and MARKING

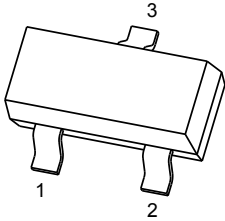
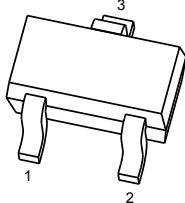
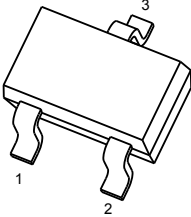
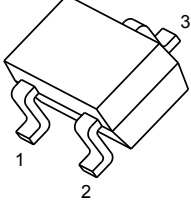
<p>DTC114ECA</p>  <p>SOT-23</p> <p>1. IN 2. GND 3. OUT</p>	<p>DTC114EE</p>  <p>SOT-523</p> <p>1. IN 2. GND 3. OUT</p>
<p>DTC114EUA</p>  <p>SOT-323</p> <p>1. IN 2. GND 3. OUT</p>	<p>DTC114EKA</p>  <p>SOT-23-3L</p> <p>1. IN 2. GND 3. OUT</p>

MAXIMUM RATINGS(Ta=25°C unless otherwise noted)

Symbol	Parameter	Limits(DTC114E□)					Unit
			E	UA	CA	KA	
V _{CC}	Supply Voltage	50					V
V _{IN}	Input Voltage	-10~+40					V
I _O	Output Current	50					mA
I _{CM}	Peak Collector Current	100					mA
P _D	Power Dissipation		150	200	200	200	mW
T _J	Junction Temperature	150					°C
T _{stg}	Storage Temperature	-55~+150					°C

ELECTRICAL CHARACTERISTICS (Ta=25°C unless otherwise specified)

Parameter	Symbol	Conditions	Min	Typ	Max	Unit
Input voltage	V _{I(off)}	V _{CC} =5V, I _O =100μA	0.5			V
	V _{I(on)}	V _O =0.3V, I _O =10mA			3	V
Output voltage	V _{O(on)}	I _O /I _I =10mA/0.5mA			0.3	V
Input current	I _I	V _I =5V			0.88	mA
Output current	I _{O(off)}	V _{CC} =50V, V _I =0			0.5	μA
DC current gain	G _I	V _O =5V, I _O =5mA	30			
Input resistance	R ₁		7	10	13	kΩ
Resistance ratio	R ₂ /R ₁		0.8	1	1.2	
Transition frequency	f _T	V _O =10V, I _O =5mA, f=100MHz		250		MHz

TYPICAL CHARACTERISTICS

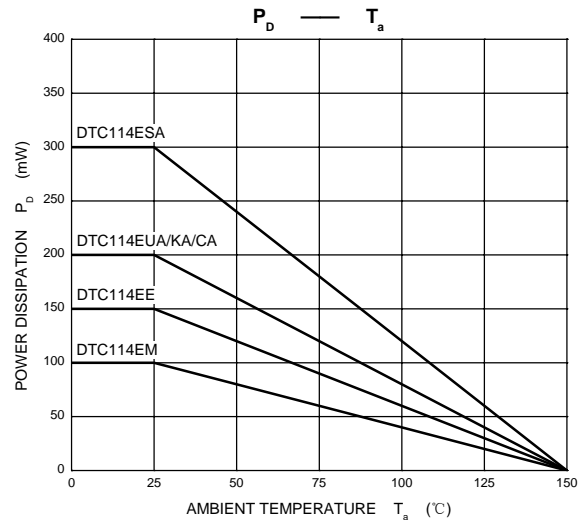
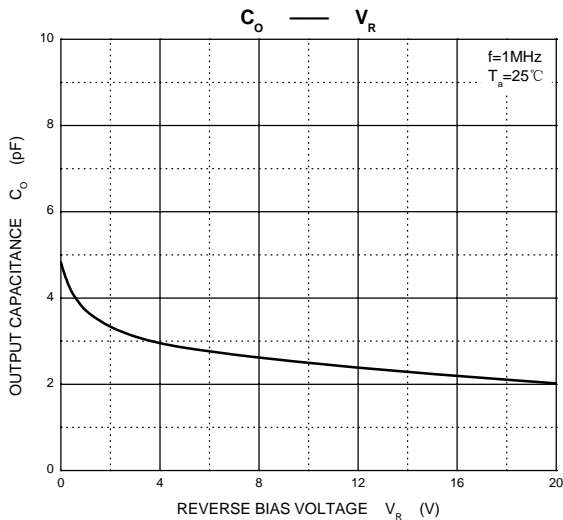
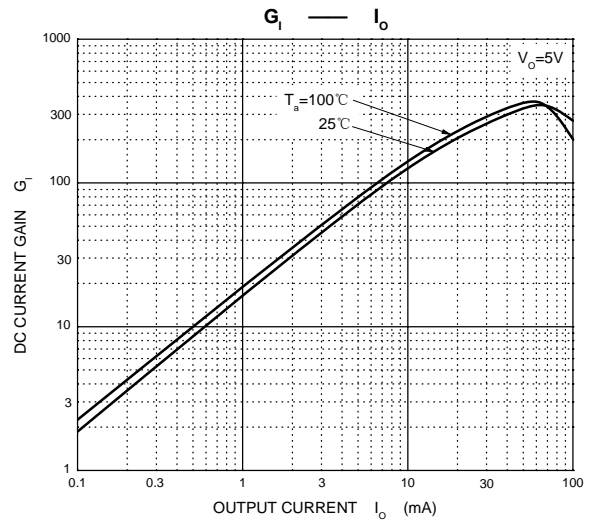
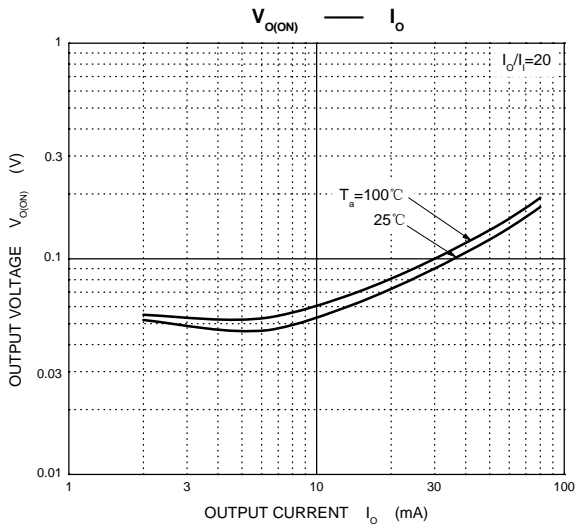
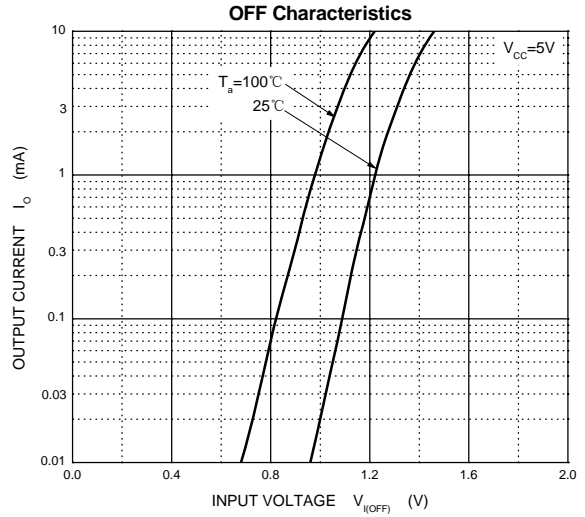
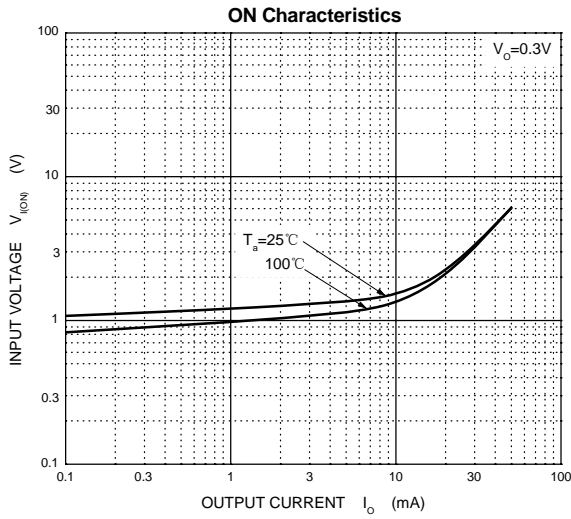

PACKAGE OUTLINE

SOT-323

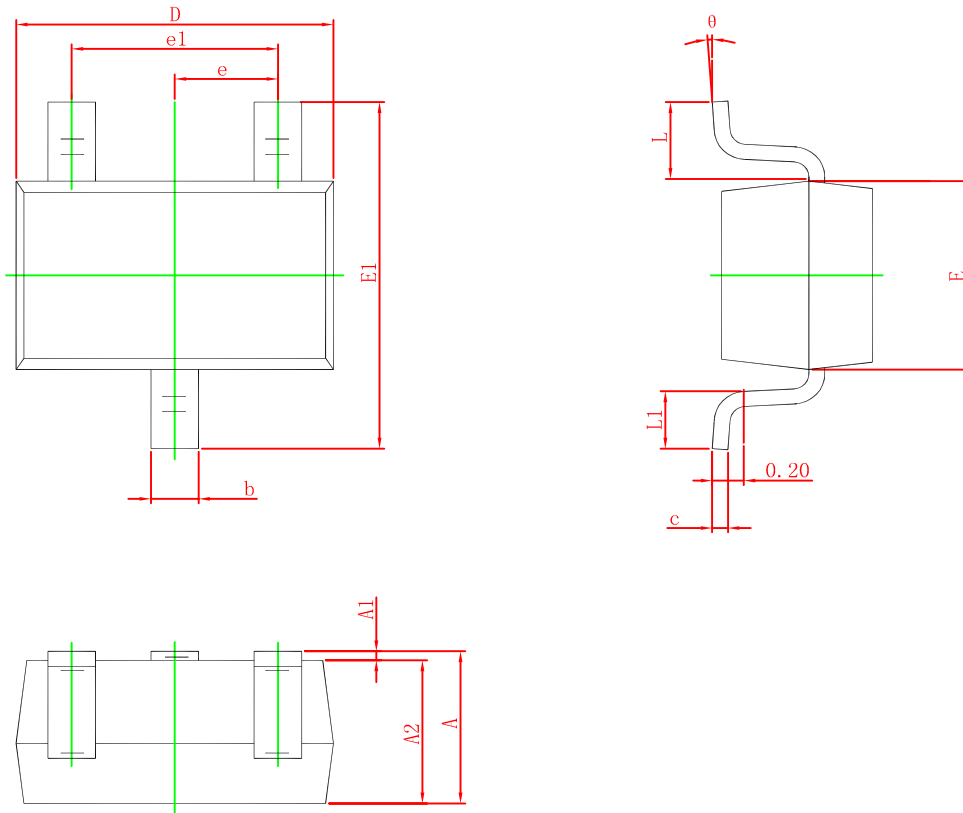

Symbol	Dimensions In Millimeters		Dimensions In Inches	
	Min.	Max.	Min.	Max.
A	0.900	1.100	0.035	0.043
A1	0.000	0.100	0.000	0.004
A2	0.900	1.000	0.035	0.039
b	0.200	0.400	0.008	0.016
c	0.080	0.150	0.003	0.006
D	2.000	2.200	0.079	0.087
E	1.150	1.350	0.045	0.053
E1	2.150	2.450	0.085	0.096
e	0.650 TYP.		0.026 TYP.	
e1	1.200	1.400	0.047	0.055
L	0.525 REF.		0.021 REF.	
L1	0.260	0.460	0.010	0.018
θ	0°	8°	0°	8°

单击下面可查看定价，库存，交付和生命周期等信息

[>>TWGMC\(台湾迪嘉\)](#)