

SOT-23 Plastic-Encapsulated MOSFETS

P-Channel Enhancement Mode Field Effect Transistor

General Description

The AO3407 uses advanced trench technology to provide excellent $R_{DS(on)}$ with low gate charge. This device is suitable for use as a load switch or in PWM applications.

MARKING

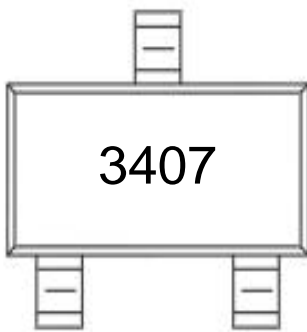

Equivalent Circuit

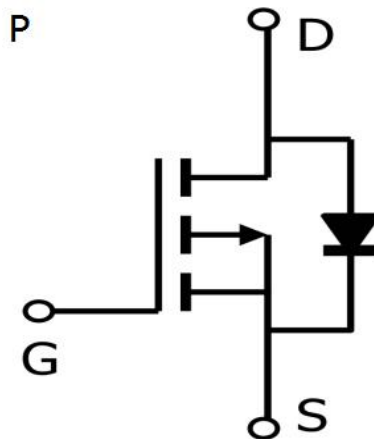

SOT-23

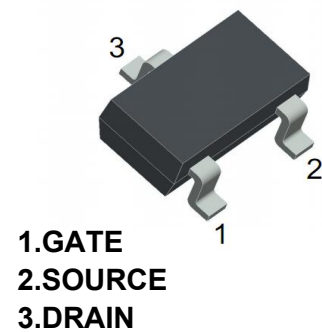

Maximum ratings ($T_a=25^{\circ}\text{C}$ unless otherwise noted)

Parameter	Symbol	Value	Unit
Drain-Source Voltage	V_{DS}	-30	V
Gate-Source Voltage	V_{GS}	± 20	V
Continuous Drain Current	I_D	-4.1	A
Power Dissipation	P_D	350	mW
Thermal Resistance from Junction to Ambient	$R_{\theta JA}$	357	$^{\circ}\text{C}/\text{W}$
Junction Temperature	T_J	150	$^{\circ}\text{C}$
Storage Temperature	T_{stg}	-55~+150	$^{\circ}\text{C}$

Electrical characteristics (T_a=25°C unless otherwise noted)

Parameter	Symbol	Test Condition	Min	Typ	Max	Units
Static characteristics						
Drain-source breakdown voltage	BV _{DSS}	V _{GS} = 0V, I _D = -250μA	-30			V
Zero gate voltage drain current	I _{DSS}	V _{DS} = -24V, V _{GS} = 0V			-1	μA
Gate-source leakage current	I _{GSS}	V _{GS} = ±20V, V _{DS} = 0V			±100	nA
Drain-source on-resistance (note 1)	R _{DS(on)}	V _{GS} = -10V, I _D = -4.1A			60	mΩ
		V _{GS} = -4.5V, I _D = -3A			87	mΩ
Forward transconductance (note 1)	g _{FS}	V _{DS} = -5V, I _D = -4A	5.5			S
Gate threshold voltage	V _{GS(th)}	V _{DS} = V _{GS} , I _D = -250μA	-1		-3	V
Diode forward voltage (note 1)	V _{SD}	I _S = -1A, V _{GS} = 0V			-1	V
Dynamic characteristics (note 2)						
Input capacitance	C _{iss}	V _{DS} = -15V, V _{GS} = 0V, f = 1MHz		700		pF
Output capacitance	C _{oss}			120		pF
Reverse transfer capacitance	C _{rss}			75		pF
Switching Characteristics (note 2)						
Turn-on delay time	t _{d(on)}	V _{GS} = -10V, V _{DS} = -15V, R _L = 3.6Ω, R _{GEN} = 3Ω		8.6		ns
Turn-on rise time	t _r			5.0		ns
Turn-off delay time	t _{d(off)}			28.2		ns
Turn-off fall time	t _f			13.5		ns

Notes:

1. Pulse test: Pulse width ≤300μs, duty cycle ≤2%.
2. These parameters have no way to verify.

Typical Characteristics

Output Characteristics

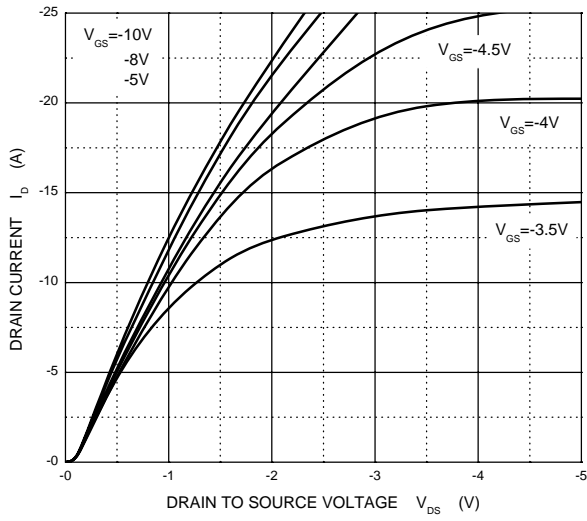

Transfer Characteristics

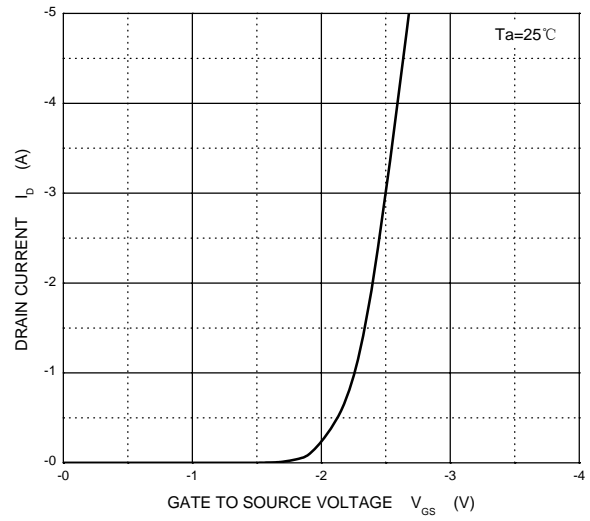

$R_{DS(ON)}$ — I_D

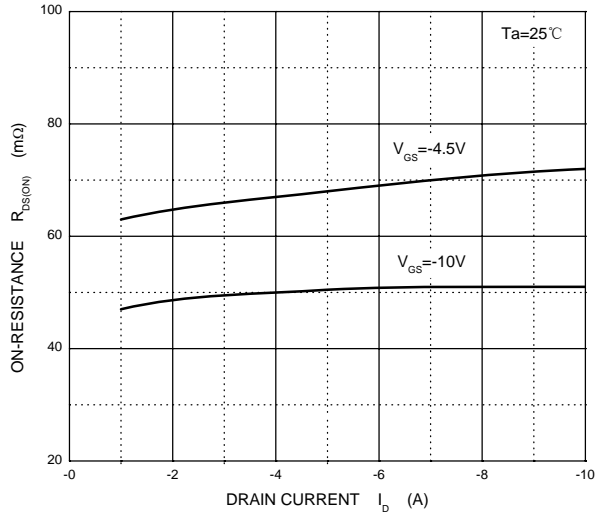

$R_{DS(ON)}$ — V_{GS}

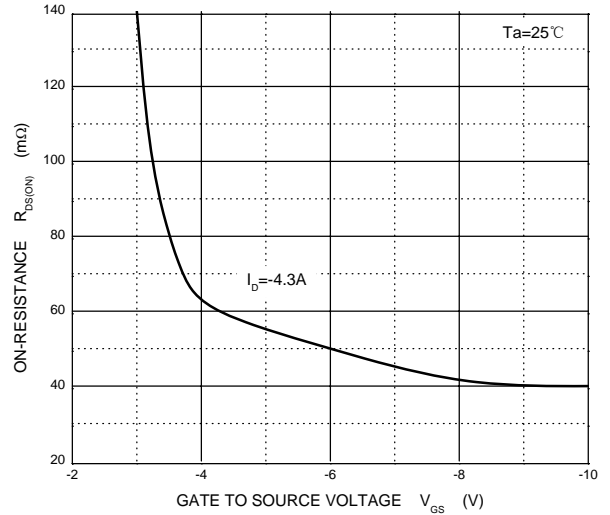

I_S — V_{SD}

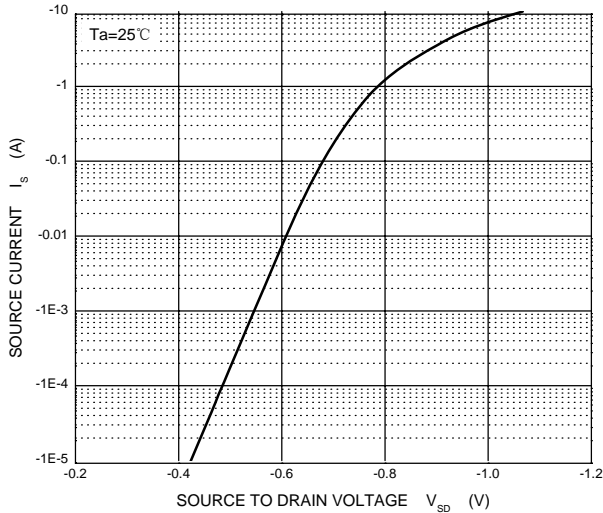

PACKAGE OUTLINE

Plastic surface mounted package; 3 leads

SOT-23

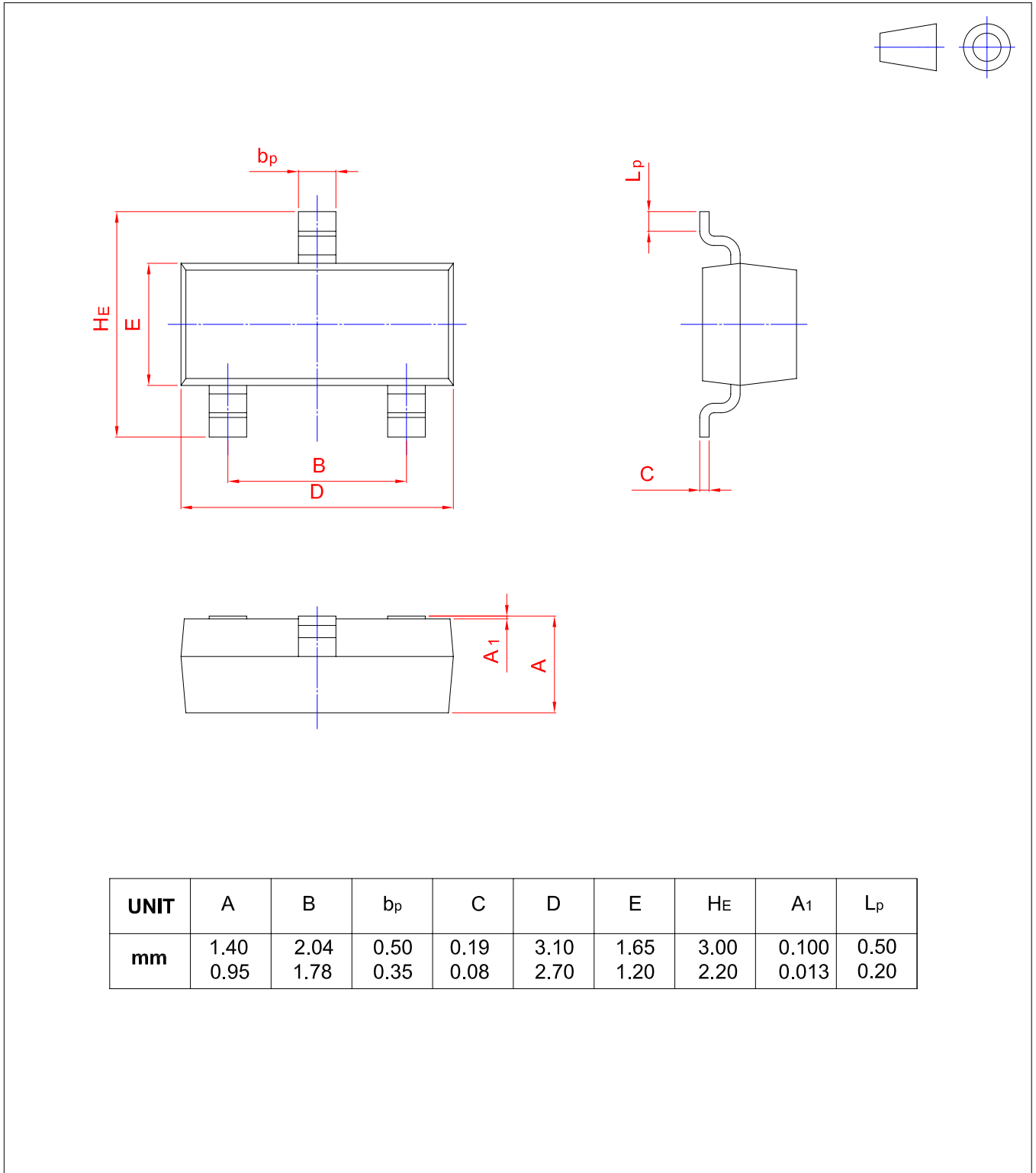

单击下面可查看定价，库存，交付和生命周期等信息

[>>TWGMC\(台湾迪嘉\)](#)