



SS32F THRU SS3200F

SURFACE MOUNT SCHOTTKY BARRIER RECTIFIER

Reverse Voltage - 20 to 200 Volts Forward Current - 3.0 Ampere

SMAF

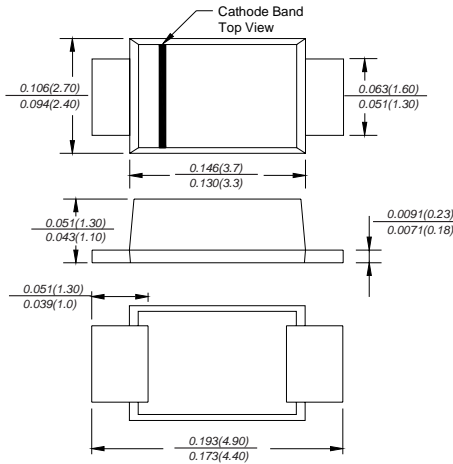

FEATURES

- ◆ The plastic package carries Underwriters Laboratory Flammability Classification 94V-0
- ◆ For surface mounted applications
- ◆ Metal silicon junction, majority carrier conduction
- ◆ Low power loss, high efficiency
- ◆ Built-in strain relief, ideal for automated placement
- ◆ High forward surge current capability
- ◆ High temperature soldering guaranteed: 260°C/10 seconds at terminals

MECHANICAL DATA

Case: JEDEC SMAF molded plastic body
Terminals: leads solderable per MIL-STD-750, Method 2026
Polarity: Color band denotes cathode end
Mounting Position: Any
Weight: 0.0018 ounce, 0.064 grams

MAXIMUM RATINGS AND ELECTRICAL CHARACTERISTICS

Ratings at 25°C ambient temperature unless otherwise specified.

Single phase half-wave 60Hz, resistive or inductive load, for capacitive load current derate by 20%.

| TWGMC Catalog Number | SYMBOLS | SS32F | SS33F | SS34F | SS35F | SS36F | SS38F | SS310F | SS3150F | SS3200F | UNITS | |
|---|-----------------|-------------|-------|-------|-------|-------|-------------|--------|---------|---------|-------|----|
| Maximum repetitive peak reverse voltage | V_{RRM} | 20 | 30 | 40 | 50 | 60 | 80 | 100 | 150 | 200 | VOLTS | |
| Maximum RMS voltage | V_{RMS} | 14 | 21 | 28 | 35 | 42 | 56 | 70 | 105 | 140 | VOLTS | |
| Maximum DC blocking voltage | V_{DC} | 20 | 30 | 40 | 50 | 60 | 80 | 100 | 150 | 200 | VOLTS | |
| Maximum average forward rectified current at T_L (see fig.1) | $I_{(AV)}$ | 3.0 | | | | | | | | | Amp | |
| Peak forward surge current 8.3ms single half sine-wave superimposed on rated load (JEDEC Method) | I_{FSM} | 80.0 | | | | | | | | | Amps | |
| Maximum instantaneous forward voltage at 3.0A | V_F | 0.55 | | 0.70 | | 0.85 | | 0.95 | | Volts | | |
| Maximum DC reverse current at rated DC blocking voltage | I_R | 0.5 | | | 0.2 | | | | | | mA | |
| | | 20.0 | | | 10 | | 2.0 | | | | | |
| Typical junction capacitance (NOTE 1) | C_J | 500 | | | 300 | | | | | | | pF |
| Typical thermal resistance (NOTE 2) | $R_{\theta JA}$ | 55.0 | | | | | | | | | °C/W | |
| Operating junction temperature range | T_J | -50 to +125 | | | | | -50 to +150 | | | | | °C |
| Storage temperature range | T_{STG} | -50 to +150 | | | | | | | | | °C | |

Note: 1. Measured at 1MHz and applied reverse voltage of 4.0V D.C.
 2. P.C.B. mounted with 0.2x0.2" (5.0x5.0mm) copper pad areas

RATINGS AND CHARACTERISTIC CURVES SS32F THRU SS3200F

AVERAGE FORWARD RECTIFIED CURRENT, AMPERES

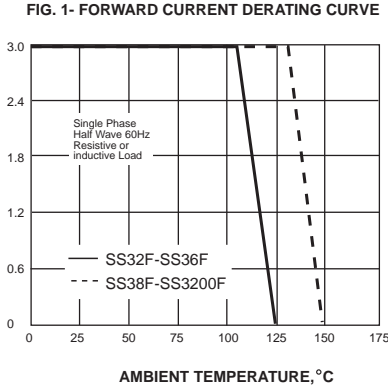

PEAK FORWARD SURGE CURRENT, AMPERES

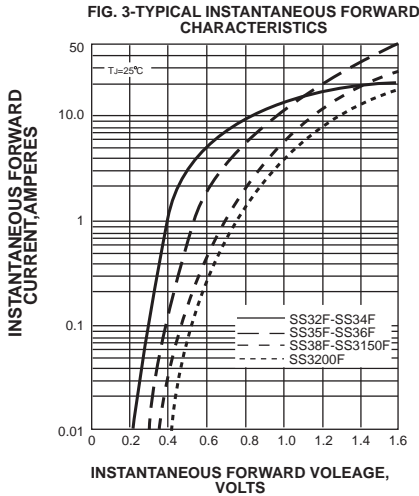
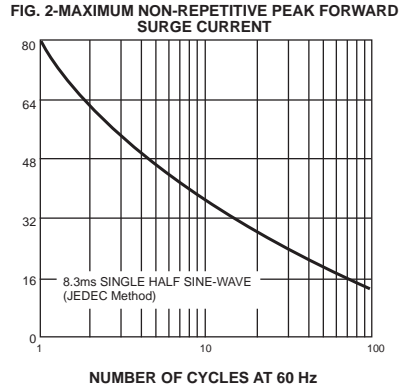

INSTANTANEOUS REVERSE CURRENT, MILLIAMPERES

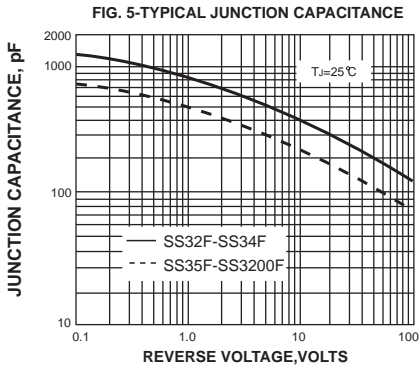
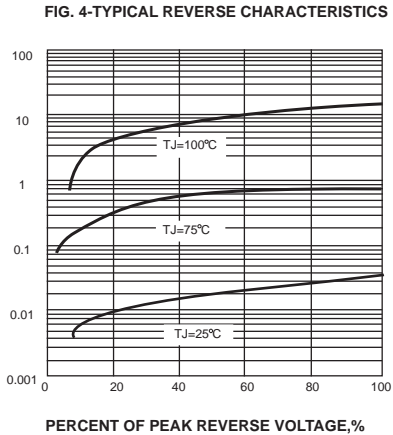

TRANSIENT THERMAL IMPEDANCE, °C/W

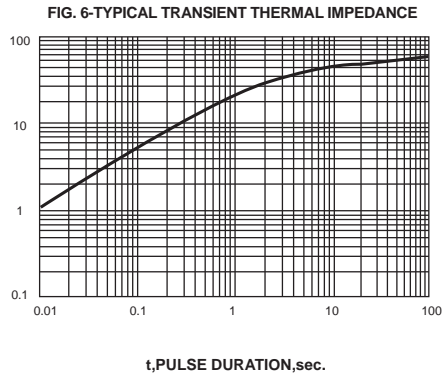

单击下面可查看定价，库存，交付和生命周期等信息

[>>TWGMC\(台湾迪嘉\)](#)