

SURFACE MOUNT SCHOTTKY BARRIER RECTIFIER

PINNING

PIN	DESCRIPTION
1	Cathode
2	Anode

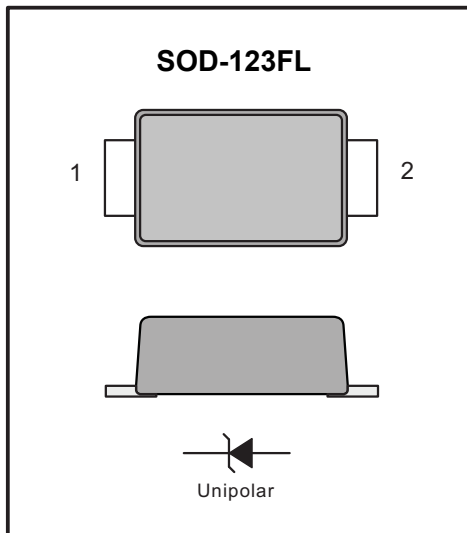

Features

- ◆ The plastic package carries Underwriters Laboratory Flammability Classification 94V-0
- ◆ For surface mounted applications
- ◆ Metal silicon junction, majority carrier conduction
- ◆ Low power loss, high efficiency
- ◆ Built-in strain relief, ideal for automated placement
- ◆ High forward surge current capability
- ◆ High temperature soldering guaranteed: 250 °C/10 seconds at terminals

Mechanical Data

- ◆ Case : JEDEC SOD-123FL molded plastic body
- ◆ Terminals : Solderable per MIL-STD-750, Method 2026 Polarity : Color band denotes cathode end
- ◆ Mounting Position : Any
- ◆ Weight : 0.0007 ounce, 0.02 grams

Maximum Ratings And Electrical Characteristics

Ratings at 25°C ambient temperature unless otherwise specified.

Single phase half-wave 60Hz, resistive or inductive load, for capacitive load current derate by 20%.

Parameter	SYMBOLS	DSK12	DSK14	DSK15	DSK16	DSK18	DSK110	DSK115	DSK120	UNITS
		K12	K14	K15	K16	K18	K110	K115	K120	
Marking Code		K12	K14	K15	K16	K18	K110	K115	K120	
Maximum repetitive peak reverse voltage	V _{RRM}	20	40	50	60	80	100	150	200	V
Maximum RMS voltage	V _{RMS}	14	28	35	42	56	70	105	140	V
Maximum DC blocking voltage	V _{DC}	20	40	50	60	80	100	150	200	V
Maximum average forward rectified current at TL (see fig. 1)	I _(AV)	1.0								A
Peak forward surge current 8.3ms single half sine-wave superimposed on rated load (JEDEC Method)	I _{FSM}	25								A
Maximum instantaneous forward voltage at 1.0A	V _F	0.55		0.70			0.85		0.95	V
Maximum DC reverse current T _A =25°C at rated DC blocking voltage T _A =125°C	I _R	0.5				0.1				mA
		10.0				5.0				
Typical junction capacitance (NOTE 1)	C _J	110			80					pF
Typical thermal resistance (NOTE 2)	R _{θJA}	100.0								°C/W
Operating junction temperature range	T _J	-55 to +125								°C
Storage temperature range	T _{STG}	-55 to +150								°C

Note: 1. Measured at 1MHz and applied reverse voltage of 4.0V D.C.

Typical Characteristics

Fig.1 Forward Current Derating Curve

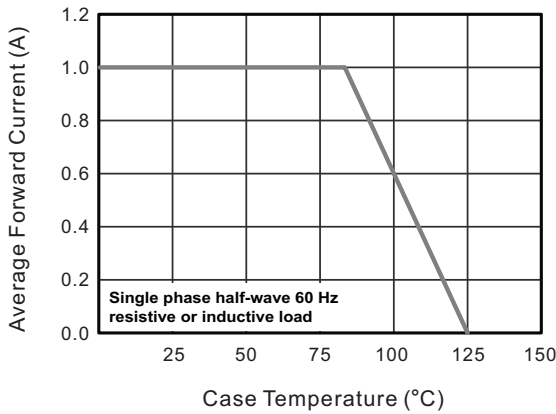

Fig.2 Typical Reverse Characteristics

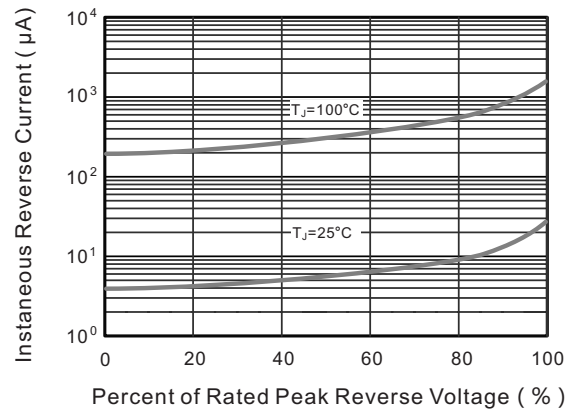

Fig.3 Typical Forward Characteristic

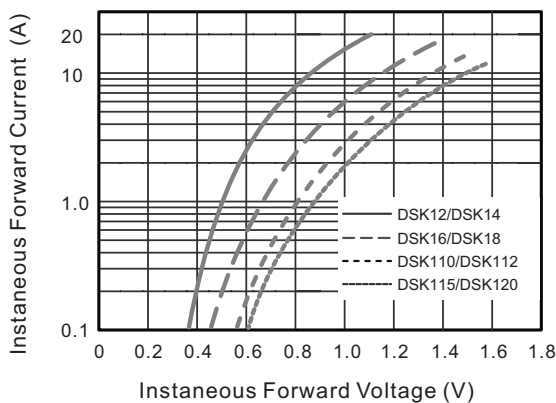

Fig.4 Typical Junction Capacitance

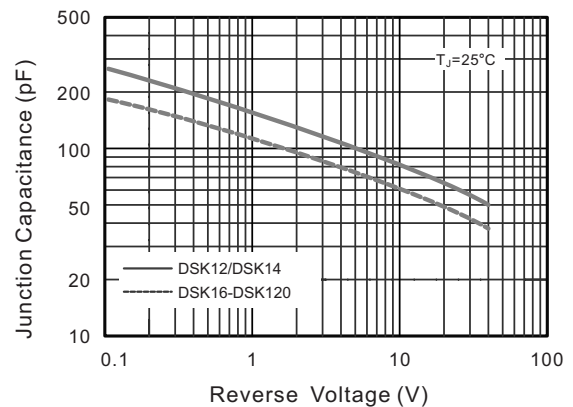

Fig.5 Maximum Non-Repetitive Peak Forward Surge Current

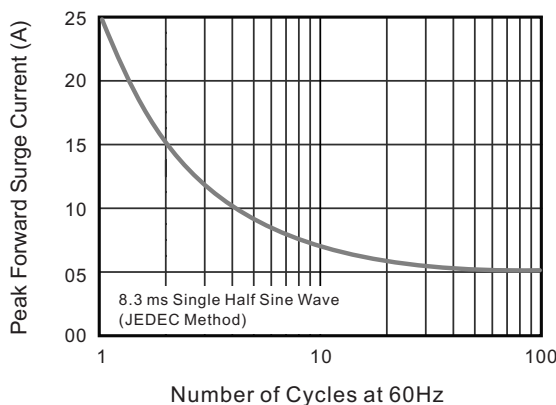
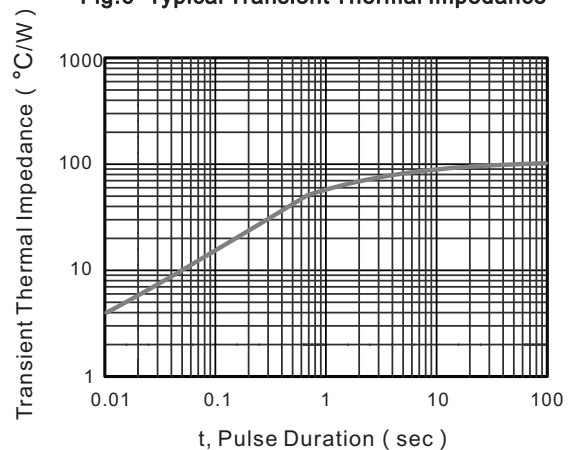

Fig.6- Typical Transient Thermal Impedance



PACKAGE OUTLINE

Plastic surface mounted package; 2 leads

SOD-123FL

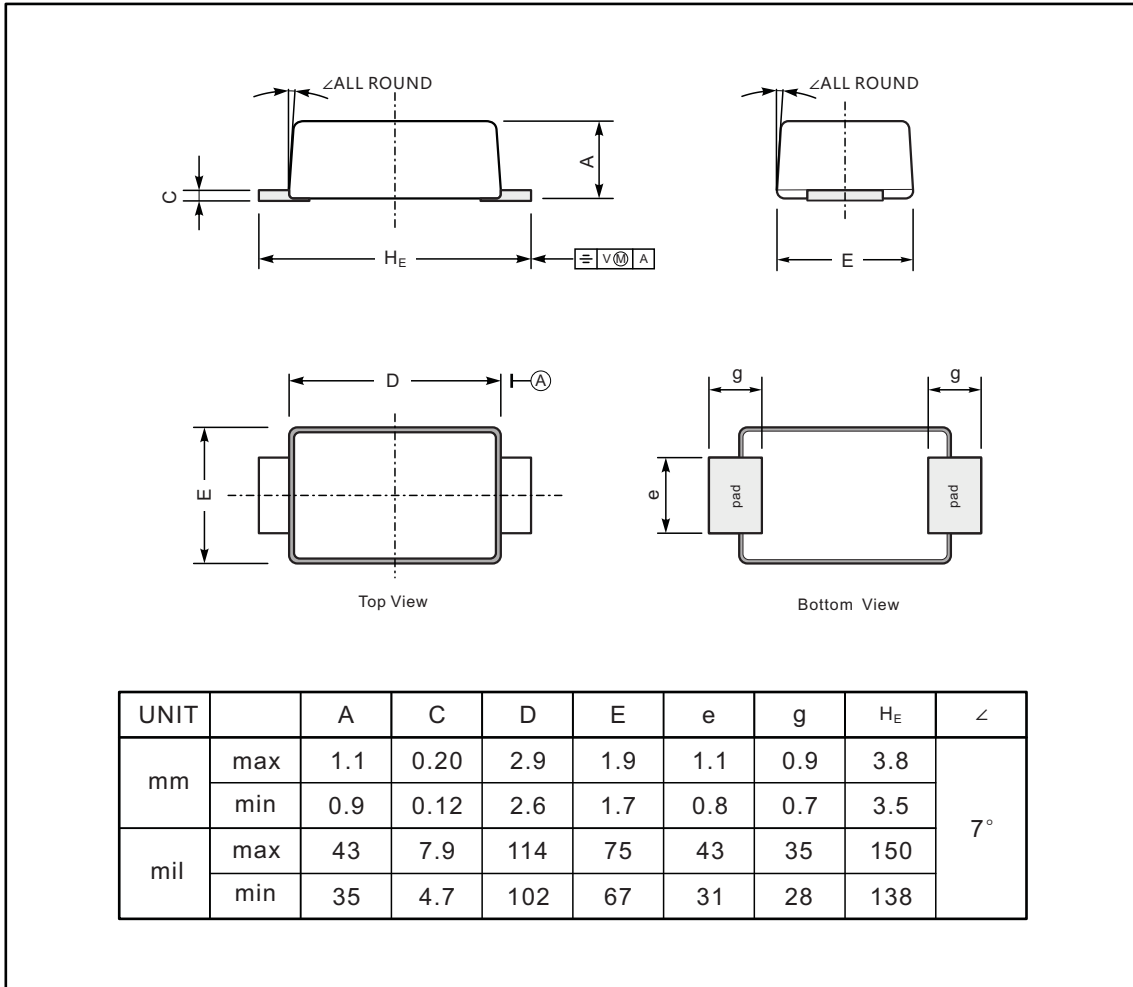

The recommended mounting pad size

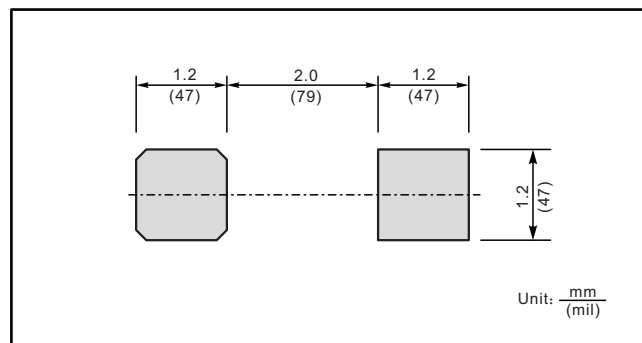

单击下面可查看定价，库存，交付和生命周期等信息

[>>TWGMC\(台湾迪嘉\)](#)