



ES2A THRU ES2M

SURFACE MOUNT SUPER FAST RECTIFIER

Reverse Voltage - 50 to 1000 Volts Forward Current - 2.0 Amperes

DO-214AA (HSMB) (Round Lead)

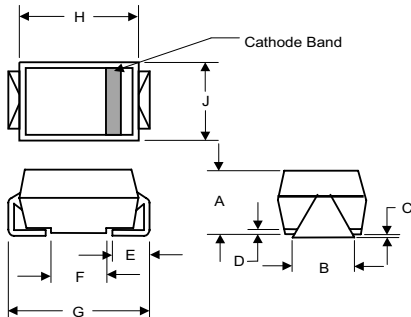

DIM	INCHES		MM		NOTE
	MIN	MAX	MIN	MAX	
A	.078	.116	1.98	2.95	
B	.075	.089	1.90	2.25	
C	.002	.008	.05	.20	
D		.02		.51	
E	.035	.055	.90	1.40	
F	.065	.091	1.65	2.32	
G	.205	.224	5.21	5.69	
H	.160	.180	4.06	4.57	
J	.130	.155	3.30	3.94	

FEATURES

- ◆ Lead Free Finish/Rohs Compliant (Note1) ("P" Suffix designates Compliant. See ordering information)
- ◆ Case Material: Molded Plastic. UL Flammability
- ◆ Classification Rating 94V-0 and MSL rating 1
- ◆ Easy Pick And Place
- ◆ High Temp Soldering: 260°C for 10 Seconds At Terminals
- ◆ Ultrafast Recovery Times For High Efficiency

MECHANICAL DATA

Case: JEDEC DO-214AA molded plastic body over passivated chip
Terminals: Solder plated, solderable per MIL-STD-750, Method 2026

Polarity: Color band denotes cathode end

Mounting Position: Any

Weight: 0.005 ounce, 0.138 grams

MAXIMUM RATINGS AND ELECTRICAL CHARACTERISTICS

Ratings at 25°C ambient temperature unless otherwise specified.

Single phase half-wave 60Hz, resistive or inductive load, for capacitive load current derate by 20%.

TWGMC Catalog Number	SYMBOLS	ES2A	ES2B	ES2C	ES2D	ES2E	ES2G	ES2J	ES2K	ES2M	UNITS
Maximum repetitive peak reverse voltage	V_{RRM}	50	100	150	200	300	400	600	800	1000	VOLTS
Maximum RMS voltage	V_{RMS}	35	70	105	140	210	280	420	560	700	VOLTS
Maximum DC blocking voltage	V_{DC}	50	100	150	200	300	400	600	800	1000	VOLTS
Maximum average forward rectified current at $T_L=55^\circ\text{C}$	$I_{(AV)}$	2.0									Amps
Peak forward surge current 8.3ms single half sine-wave superimposed on rated load (JEDEC Method)	I_{FSM}	50.0									Amps
Maximum instantaneous forward voltage at 2.0A	V_F	0.975			1.35			1.7			Volts
Maximum DC reverse current $T_A=25^\circ\text{C}$ at rated DC blocking voltage $T_A=100^\circ\text{C}$	I_R	5.0 150.0									μA
Maximum reverse recovery time (NOTE 1)	t_{rr}	50			60			100			ns
Typical junction capacitance (NOTE 2)	C_J	25.0									pF
Typical thermal resistance (NOTE 3)	$R_{\theta JA}$	20.0									$^\circ\text{C}/\text{W}$
Operating junction and storage temperature range	$T_J T_{STG}$	-50 to +150									$^\circ\text{C}$

Note: 1.Reverse recovery condition $I_F=0.5\text{A}$, $I_R=1.0\text{A}$, $I_{rr}=0.25\text{A}$

2.Measured at 1MHz and applied reverse voltage of 4.0V D.C.

3.Pulse test: Pulse width 200 sec, Duty cycle 2%

4.High Temperature Solder Exemptions Applied, see EU Directive Annex 7.

RATINGS AND CHARACTERISTIC CURVES ES2A THRU ES2M

Figure 1
Typical Forward Characteristics

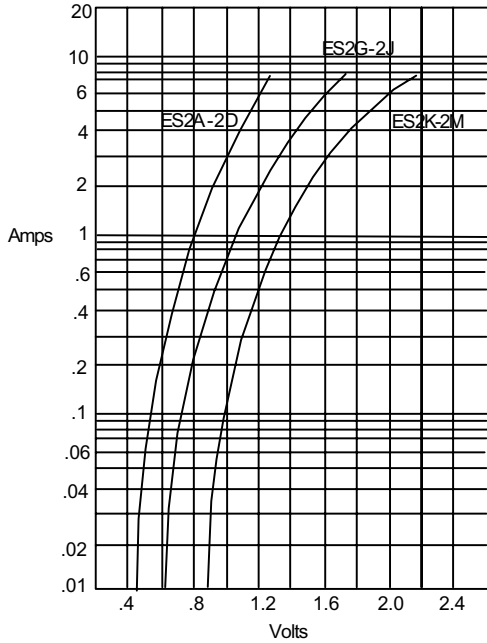

Instantaneous Forward Current - Amperes versus
Instantaneous Forward Voltage - Volts

Figure 2
Forward Derating Curve

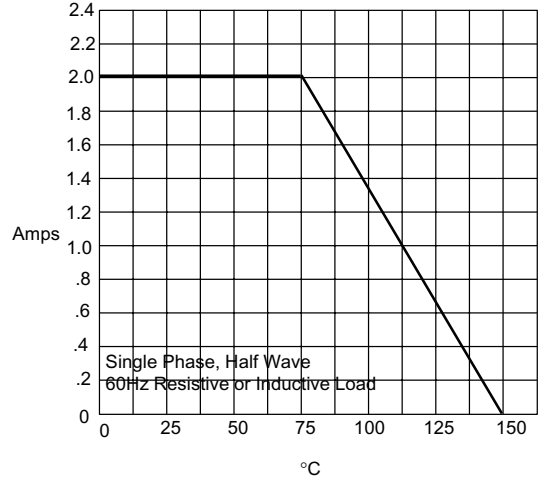

Average Forward Rectified Current - Amperes versus
Ambient Temperature - °C

Figure 3
Junction Capacitance

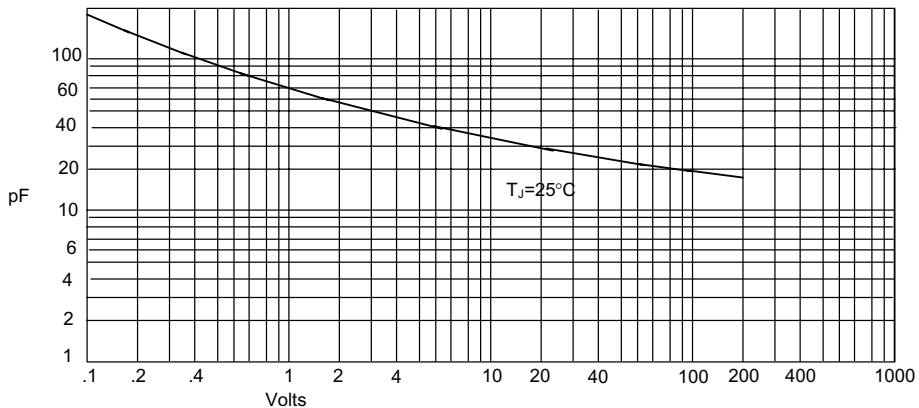

Junction Capacitance - pF versus
Reverse Voltage - Volts

RATINGS AND CHARACTERISTIC CURVES ES2A THRU ES2M

Figure 4
Peak Forward Surge Current

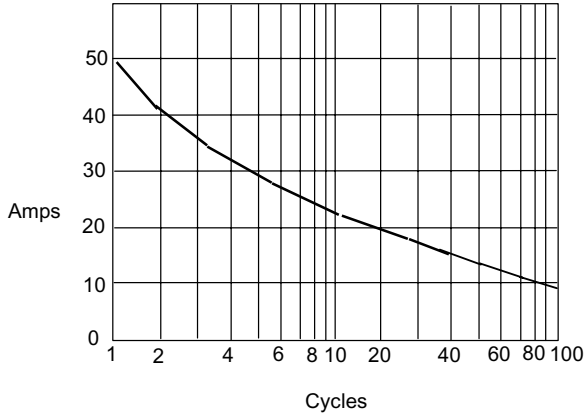

Peak Forward Surge Current - Amperes *versus*
Number Of Cycles At 60Hz - Cycles

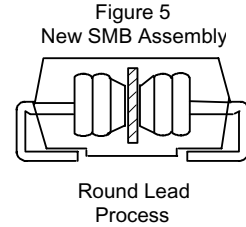
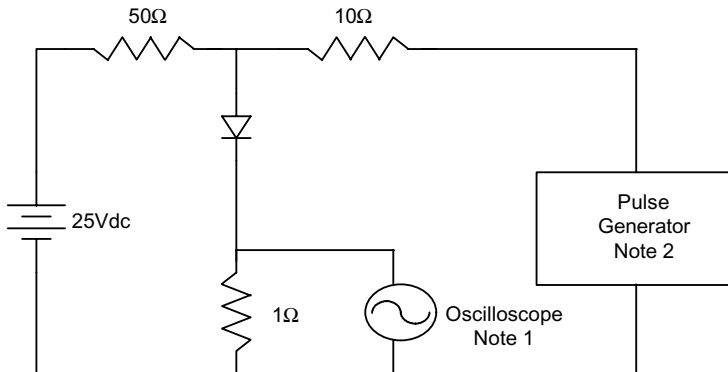
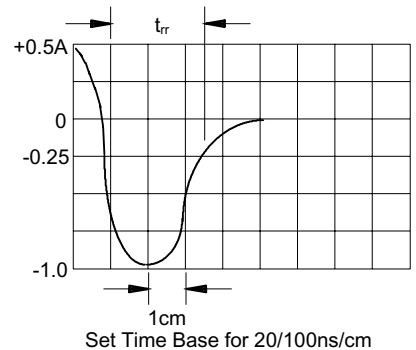

Figure 6
Reverse Recovery Time Characteristic And Test Circuit Diagram



Notes:

1. Rise Time = 7ns max.
Input impedance = 1 megohm, 22pF
2. Rise Time = 10ns max.
Source impedance = 50 ohms
3. Resistors are non-inductive



单击下面可查看定价，库存，交付和生命周期等信息

[>>TWGMC\(台湾迪嘉\)](#)