

EVK-MAYA-W1

Evaluation kit for MAYA-W1 host-based modules

User guide

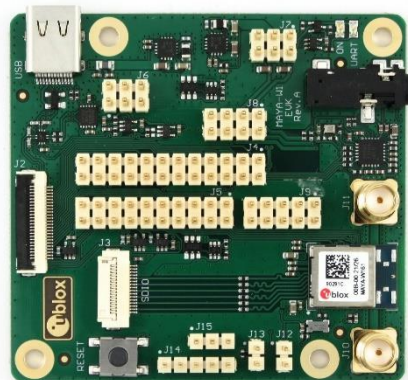

Abstract

This document describes how to set up the EVK-MAYA-W1 evaluation kit to evaluate MAYA-W1 series multiradio modules with Wi-Fi and Bluetooth.

Document information

Title	EVK-MAYA-W1		
Subtitle	Evaluation kit for MAYA-W1 host-based modules		
Document type	User guide		
Document number	UBX-21039658		
Revision and date	R01	24-Nov-2021	
Disclosure restriction	C1 – Public		

This document applies to the following products:

Product name	Type number	Hardware version	PCN reference
EVK-MAYA-W161	EVK-MAYA-W161-00B-00	Rev. A	N/A
EVK-MAYA-W166	EVK-MAYA-W166-00B-00	Rev. A	N/A

u-blox or third parties may hold intellectual property rights in the products, names, logos and designs included in this document. Copying, reproduction, modification or disclosure to third parties of this document or any part thereof is only permitted with the express written permission of u-blox.

The information contained herein is provided "as is" and u-blox assumes no liability for its use. No warranty, either express or implied, is given, including but not limited to, with respect to the accuracy, correctness, reliability and fitness for a particular purpose of the information. This document may be revised by u-blox at any time without notice. For the most recent documents, visit www.u-blox.com.

Copyright © u-blox AG.

Contents

Document information	2
Contents	3
1 Kit description.....	4
1.1 Overview.....	4
1.2 Kit includes	5
1.3 Software.....	6
1.3.1 Driver source code	6
1.3.2 Calibration data.....	6
1.4 System requirements	7
1.5 Operating conditions.....	7
2 Getting started	8
3 Board description	10
3.1 Block diagram	10
3.2 Jumpers and connectors	11
3.3 Power supply configuration	12
3.3.1 Internal or external supply	12
3.3.2 VIO configuration.....	13
3.3.3 Current measurement.....	13
3.4 Boot configuration	13
3.5 Host interfaces.....	13
3.5.1 SDIO card interface	14
3.5.2 M.2 card interface	14
3.5.3 Bluetooth host interface	15
3.6 Bluetooth audio interface.....	16
3.7 GPIOs	17
3.8 Antenna interfaces.....	17
3.9 Other interfaces	17
3.10 LEDs.....	17
3.11 Reset button	18
3.12 Schematics.....	18
Appendix	19
A Glossary	19
Related documents	20
Revision history	21
Contact.....	22

1 Kit description

The MAYA-W1 series comprises ultra-compact multiradio modules with Wi-Fi 4 and Bluetooth 5.1, including variants with or without an internal antenna. MAYA-W1 series supports dual band IEEE 802.11a/b/g/n Wi-Fi standards delivering up to 150 Mbps data throughput, and it supports both Bluetooth BR/EDR and the full Bluetooth Low Energy 5.1 feature set. MAYA-W166 series is based on the NXP IW416 chipset.

The modules require a host processor and connect to it through SDIO for Wi-Fi, high-speed UART for Bluetooth, and PCM/I2S for Bluetooth audio. The supported operating systems include Linux and Android. Wi-Fi/Bluetooth support for RTOS is provided by the NXP MCUXpresso SDK on NXP i.MX RT MCUs.

EVK-MAYA-W1 allows an external host processor to access several practical features for testing and evaluating the Wi-Fi and Bluetooth connectivity supported in MAYA-W1 series modules, including:

- External connectors to all host interfaces through SD card and M.2 key E adapters
- USB interface to easily access the Bluetooth UART interface via a USB-to-UART bridge
- Digital and analog audio interfaces for Bluetooth
- SMA connectors for external antennas (EVK-MAYA-W161)
- GPIO pins and other module interfaces are accessible through pin headers
- Multiple power supply options

For more information about MAYA-W1 modules, see also the MAYA-W1 series data sheet [1] and system integration manual [2].

1.1 Overview

Table 1 lists the available evaluation kit versions:

Evaluation kit	Ordering code	Description	Suitable for evaluation of
EVK-MAYA-W161	EVK-MAYA-W161-00B	Evaluation kit for MAYA-W161: Two external antennas for dual-band Wi-Fi 4 and Bluetooth 5.1	MAYA-W160, MAYA-W161
EVK-MAYA-W166	EVK-MAYA-W166-00B	Evaluation kit for MAYA-W166: Single embedded PCB antenna for dual-band Wi-Fi 4 and Bluetooth 5.1	MAYA-W166

Table 1: Available EVK-MAYA-W1 evaluation kits

Figure 1 shows the main components of the EVK-MAYA-W1 evaluation board.

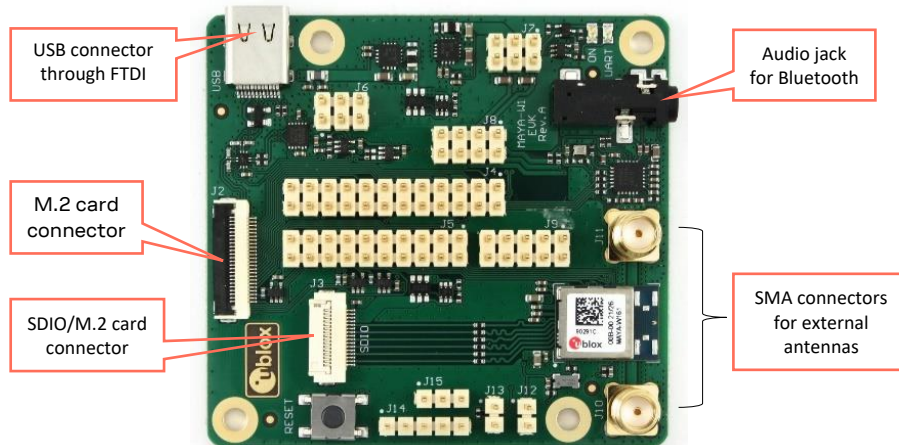

Figure 1: Evaluation board of EVK-MAYA-W161 overview showing main connectors

1.2 Kit includes

Table 2 shows the various components included in the EVK-MAYA-W1.







Part	Description	Outline
Evaluation board (EVB)	<p>Evaluation board for the MAYA-W1 series modules.</p> <p>EVK-MAYA-W161 includes SMA antenna connectors that connect to external antennas for Wi-Fi and Bluetooth.</p> <p>EVK-MAYA-W166 uses the internal PCB antenna on MAYA-W166.</p>	
M.2 Key E adapter	<p>M.2 Key E adapter to connect to M.2 host sockets. Two flat cables are included in the EVK to connect the adapter to ZIF connectors on the EVB:</p> <p>Molex 15166-0255 102.00 mm Cable Length, 24 Circuits</p> <p>Molex 15166-0167, 102.00 mm cable length, 16x circuits</p>	
Micro SD/SDIO adapter	<p>Micro SD to ZIF adapter for Wi-Fi SDIO host communication. The adapter is compatible with host sockets designed for micro-SD cards and supporting SDIO.</p> <p>Flat cable: Molex 15166-0167, 102.00 mm cable length, 16x circuits</p>	
Full-size SD/SDIO adapter	<p>Full-size SD to ZIF adapter for Wi-Fi SDIO host communication. The adapter is compatible with host sockets designed for full-size SD cards and supporting SDIO.</p> <p>Flat cable: Molex 15166-0167, 102.00 mm cable length, 16x circuits</p>	
Type-C USB cable	<p>Type-C USB cable for Bluetooth host communication over UART connected via FTDI.</p>	
External antennas	<p>2 x Dual band Wi-Fi/Bluetooth antenna, Linx Technologies ANT-DB1-RAF-SMA</p>	

Table 2: EVK-MAYA-W1 component list

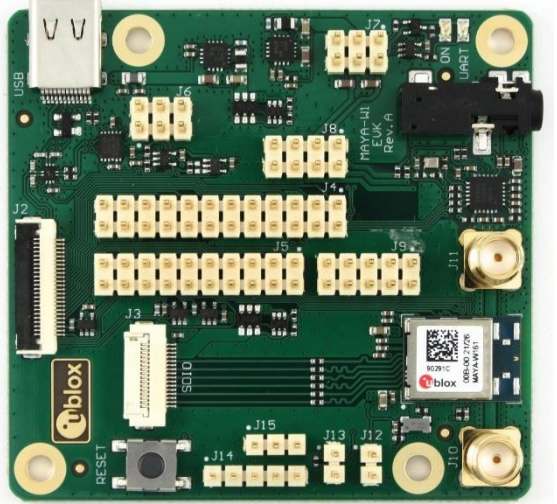
1.3 Software

MAYA-W1 series modules are based on the NXP IW416 chipset. The drivers and firmware required to operate MAYA-W1 series modules are developed by NXP and are already integrated into the Linux BSP for the NXP i.MX application processors [3] and the MCUXpresso SDK for NXP MCU devices [5].

The documentation for NXP software releases contains Wi-Fi and Bluetooth release notes and a list of supported software features. The driver source code is provided free of charge as open source under NXP licensing terms. As open source software, the drivers can be integrated or ported to other non-NXP based host platforms. Yocto recipes for the [driver](#) and [firmware](#), that can be used to develop custom Linux-based systems, are part of the NXP i.MX Linux BSP.

1.3.1 Driver source code

The latest version of the driver source code and Wi-Fi/Bluetooth firmware are available from the following open-source repositories:

- Wi-Fi driver: <https://source.codeaurora.org/external/imx/mwifiex/>
- Firmware: <https://github.com/NXP/imx-firmware/>

 Use the repository branches matching the latest Linux BSP release version. At the time of document publication, this is release 5.10.52_2.1.0.

The Wi-Fi driver uses the TCP/IP stack from the Linux kernel for data transmission and the `cfg80211` subsystem in the kernel for configuration and control. The `hci_uart` driver from the Linux kernel and BlueZ host stack are used for the Bluetooth part. For further information about initialization and configuration of the Wi-Fi and Bluetooth features, see also the NXP User Manual UM11490 [4]

[Contact](#) your local u-blox support team for information about additional software options for the MAYA-W1 series modules.

1.3.2 Calibration data

To ensure that EVK-MAYA-W1 prototypes operate correctly, calibration data must be loaded from separate configuration files. Calibration data files are available from u-blox for the MAYA-W160/W161 and the MAYA-W166 modules. Calibration data is downloaded to the module at driver load time and the calibration file is provided through the `cal_data_cfg` driver parameter.

Save the calibration file under the `/lib/firmware/nxp/` directory on the target system. The `cal_data_cfg` parameter can be set in the module parameters configuration file `/lib/firmware/nxp/wifi_mod_para.conf`, as shown in this example:

```
SD8978 = {
    cfg80211_wext=0xf
    wfd_name=p2p
    max_vir_bss=1
    cal_data_cfg=nxp/WlanCalData_ext_w161.conf
    drv_mode=7
    ps_mode=2
    auto_ds=2
    fw_name=nxp/sdiouartiw416_combo_v0.bin
}
```

1.4 System requirements

The evaluation kit has the following system requirements:

- Host (PC or embedded system) with one or more of the following connection options:
 - M.2 Key E socket for access to Wi-Fi through the SDIO host interface and for access to Bluetooth through the UART host interface
 - Micro or full-size SD card slot for access to Wi-Fi through the SDIO host interface
 - USB 2.0 interface for access to the Bluetooth UART interface through USB-to-UART bridge
- Supported operating systems:
 - Linux (3.x/4.x/5.x)
 - Android
 - FreeRTOS™ (through NXP MCUXpresso)

1.5 Operating conditions

Table 3 describes the recommended operating conditions for the EVK-MAYA-W1. For more information about power supply requirements, see also the MAYA-W1 series data sheet [1].

Symbol	Parameter	Min.	Typ	Max.	Units	
3V3	Module 3.3 V power supply voltage	3.14	3.3	3.46	V	
1V8	Module 1.8 V power supply voltage	1.71	1.8	1.89	V	
VIO / VIO_SD	Module I/O supply voltage	1.8 V	1.62	1.8	1.98	V
		3.3 V	2.97	3.3	3.47	V
VBUS_USB	EVB power supply from USB	4.5	5	5.5	V	
T _A	Ambient operating temperature	-40	-	+85	°C	
Ripple Noise	Peak-to-peak voltage ripple on all supply lines.	-	-	30	mV	

Table 3: EVK-MAYA-W1 operating conditions

2 Getting started

This chapter describes the basic settings and procedures to get started with the MAYA-W1 EVK. All referenced connectors, jumpers, and LEDs are shown in Figure 2.

 For more detailed information about the available connectors and configuration options, see also [Board description](#).

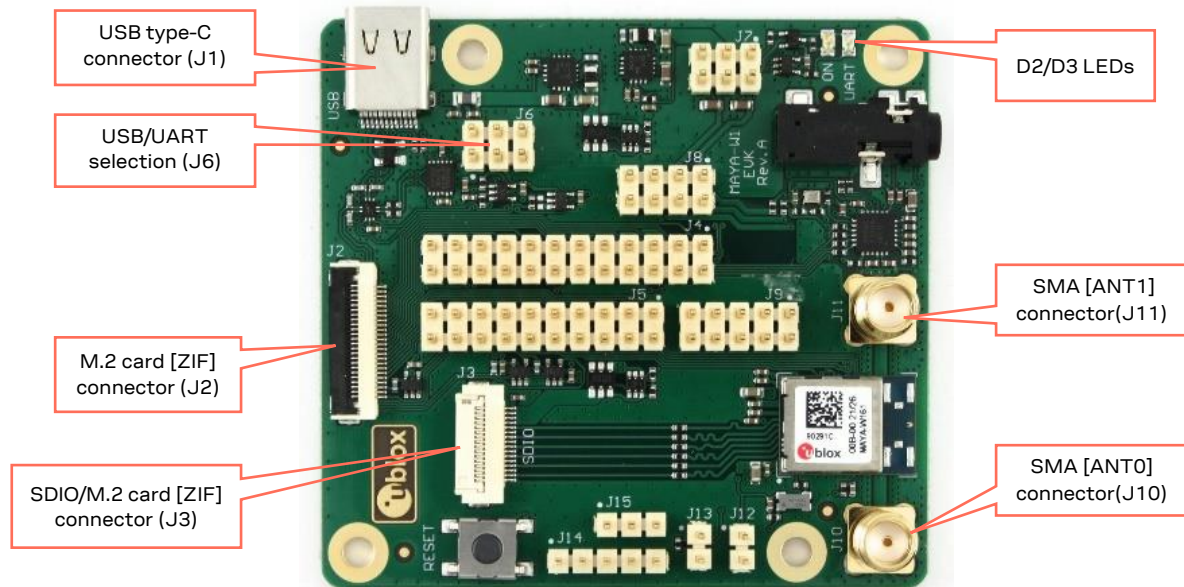



Figure 2: Evaluation board of EVK-MAYA-W161 overview showing main connectors

Follow the procedure below to evaluate MAYA-W1 series module using EVK-MAYA-W1:

1. Connect the external antennas for EVK-MAYA-W161. EVK-MAYA-W161 includes two external dual-band antennas for Wi-Fi and Bluetooth communication, which must be connected to the SMA connectors (J10 and J11) on the evaluation board.

 EVK-MAYA-W166 is equipped with an internal PCB antenna and does not include SMA connectors for connecting external antennas. For more information about the antenna connectors, see also [Antenna interfaces](#).

2. Connect the host interfaces to the host system. The EVB and supplied M.2 and SDIO adapters use zero insertion force (ZIF) connectors and flat cables for connecting the adapters. To connect the cables, gently flip up the small locking flap of the connector, align and insert the flat cable with the blue marking pointing upwards, and then close the locking flap.
 - For SDIO connection through an SD card socket on the host system, connect the micro or full-size SD card adapter with the flat cable to the SDIO connector (J3) on the EVB and insert the adapter card into the host socket. The SDIO interface is used for Wi-Fi communication with the MAYA-W1 series module.
 - A USB-to-UART bridge is included on the evaluation board to access the high speed UART interface of the MAYA-W1 series module for Bluetooth communication. To use the Bluetooth interface through USB, connect the included USB cable to the USB type-C connector on the EVB and connect it to a USB interface on the host system. Make sure that the jumper on J6 is on pins 1-2 (EXT USB) to enable Bluetooth communication over the USB connector. For information about accessing the UART interface for Bluetooth directly, see also [Bluetooth host interface](#).

- EVK-MAYA-W1 can optionally be connected to a host system through an M.2 Key E host socket. M.2 sockets with mechanical Key E are used on several host platforms, including platforms based on NXP MPUs and MCUs that support wireless connectivity modules based on NXP Wi-Fi/Bluetooth radios. M.2 Key E host sockets can support various host interfaces, including SDIO, UART, USB, and PCM/I2S. For information about using the M.2 interface with EVK-MAYA-W1, see also [M.2 interface](#).
3. Power on the host system. The Supply LED (D2) on the EVB should turn green to indicate proper power supply. At this point the module should be detected by the host system.
 -  The SDIO/M.2 and USB host sockets are used as default power supply sources for the EVB. For information about other supply options, see also [Power supply configuration](#).
 4. Install the necessary driver software for the MAYA-W1 series module, as described in [Software](#).

3 Board description

3.1 Block diagram

Figure 3 shows a block diagram of the evaluation board with the M.2 and SD card adapters.

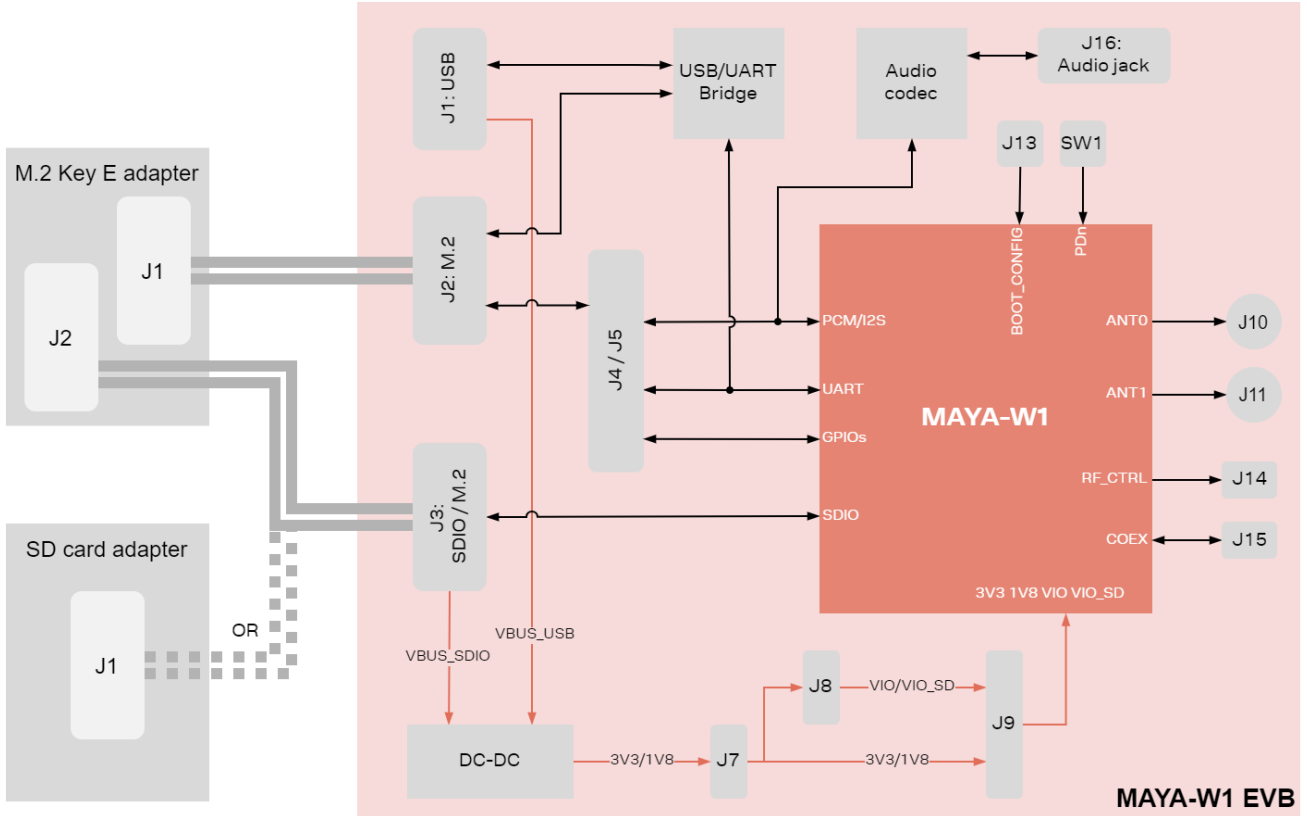

Figure 3: Block diagram of the EVB and adapter cards

3.2 Jumpers and connectors

Figure 4 shows an outline of the evaluation board and the placement of the connectors and pin headers for jumper configuration. The EVB makes all the interfaces of the MAYA-W1 series module accessible through connectors or pin headers.

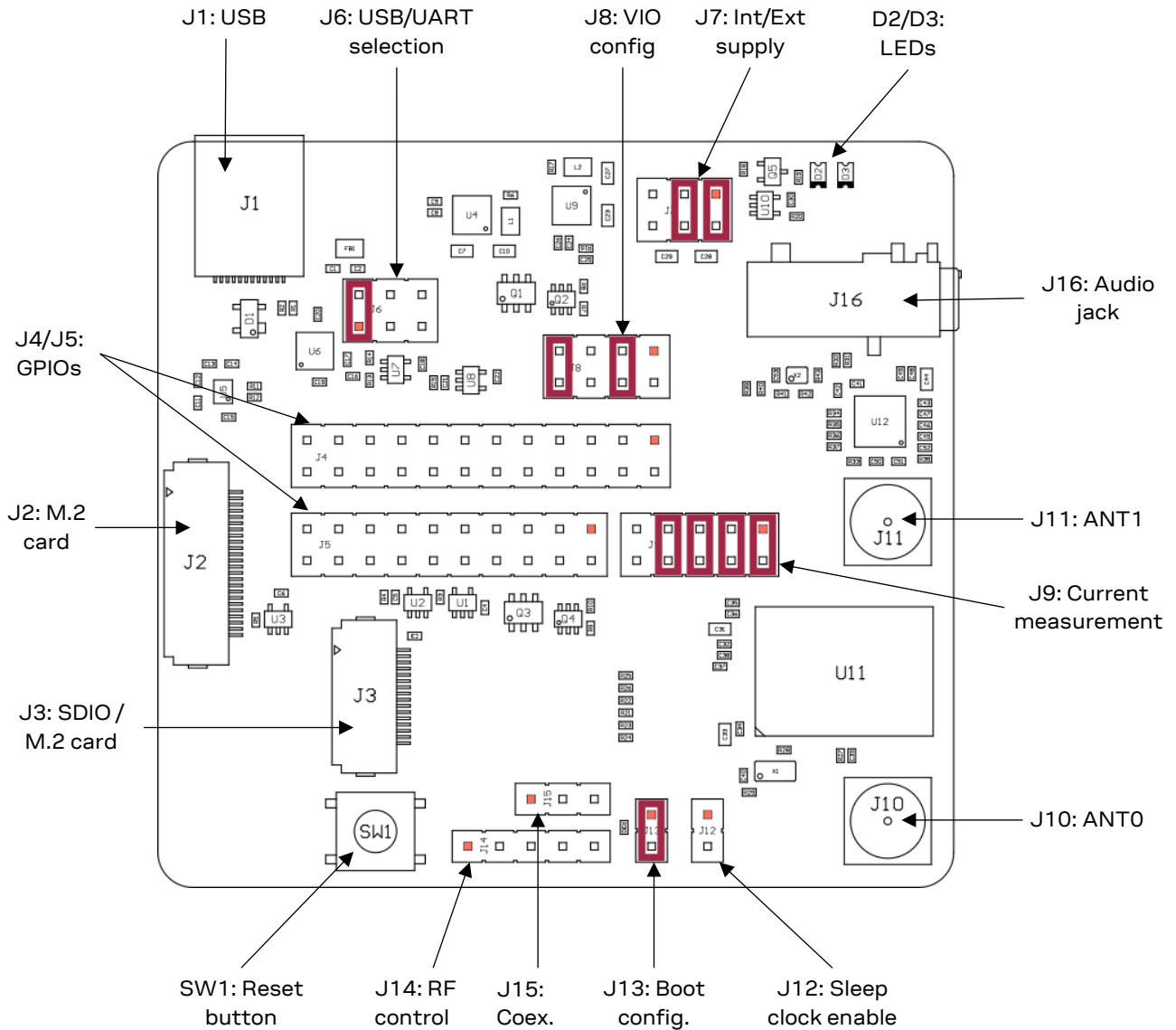

Figure 4: EVK-MAYA-W1 connectors and default jumper configuration

Table 4 provides a summary of the connectors and pin headers available on the evaluation board.

Designator	Function	Description
J1	USB connector	USB type-C connector for Bluetooth host interface
J2	M.2 card connector	Connector for M.2 card adapter
J3	SDIO/M.2 card connector	Connector for SDIO or M.2 card adapter
J4/J5	GPIOs	Module GPIOs and interfaces
J6	USB/UART selection	Pin header for USB/UART Bluetooth host interface selection
J7	Internal/external supply selection	Pin header for internal or external power supply selection
J8	VIO configuration	Pin header for VIO voltage configuration
J9	Current measurement	Pin header for current measurements
J10	ANT0	SMA connector for WLAN antenna interface (only on EVK-MAYA-W161)
J11	ANT1	SMA connector for Bluetooth antenna interface (only on EVK-MAYA-W161)
J12	Sleep clock enable	Pin header to enable/disable sleep clock
J13	Boot configuration	Pin header for MAYA-W1 boot configuration
J14	RF controls	Pin header for RF control signals. See also Other interfaces
J15	Coexistence interface	Pin header for coexistence interface See also Other interfaces
SW1	Reset button	Reset button
D2/D3	LEDs	Power supply and UART activity indicator LEDs

Table 4: MAYA-W1 evaluation board connectors

3.3 Power supply configuration

MAYA-W1 series modules are supplied with 3.3 V (**3V3**), 1.8 V (**1V8**), and selectable **VIO/VIO_SD** voltages. Power supply for the EVB can be provided from the SDIO, M.2 or USB host sockets and internal DC-DC, or from external sources. The following power supply options are available on the EVB:

- SDIO or USB interfaces: The EVB is powered from the SDIO/M.2 or USB host sockets. All internal voltages are generated by DC-DC converters on the EVB.
- External sources: 3.3 V and 1.8 V voltages for the board are supplied from external power sources through connector J7.

The current consumption of the MAYA-W1 module can be measured individually on each supply rail.

3.3.1 Internal or external supply

The EVB can be supplied through the host interfaces and voltages generated by internal DC-DC. To use internal supplies, place jumpers on pins 1-2 and 3-4 of pin header J7 (default configuration).

To use external power sources, remove the jumpers and connect the supplies directly to the **BRD_3V3**, **BRD_1V8**, and **GND** pins on J7.

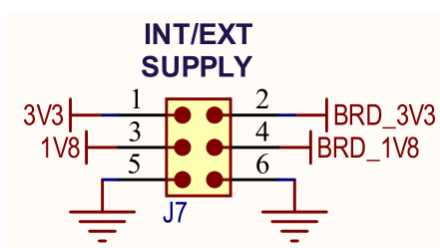

Figure 5: Internal/external supply (J7)

3.3.2 VIO configuration

The **VIO** and **VIO_SD** voltages for the MAYA-W1 module can be selected from the 1.8 V or 3.3 V board supplies with pin header J8. The default configuration is to use 1.8 V for both **VIO** (3-4) and **VIO_SD** (7-8).

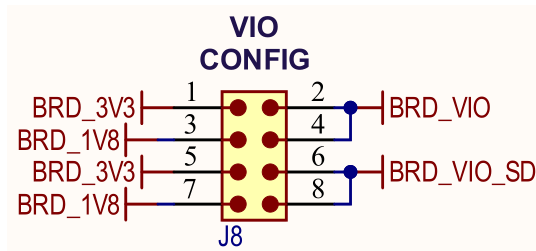

Figure 6: VIO configuration (J8)

3.3.3 Current measurement

Pin header J9 allows to measure the current consumption of the MAYA-W1 module individually on each supply rail. By default, all the board voltages are connected to MAYA-W1, through the jumpers on J9, to supply the module. To perform a current measurement, remove the jumper and place an ammeter or current probe between the respective board and module supply pins on J9.

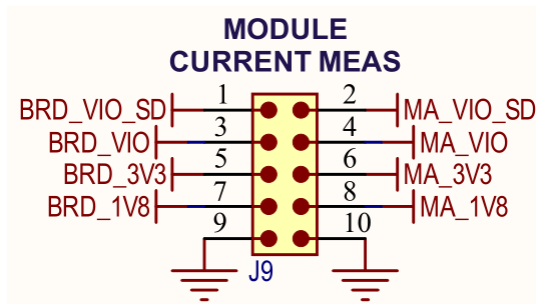



Figure 7: MAYA-W1 current measurement (J9)

3.4 Boot configuration

MAYA-W1 supports the SDIO interface for Wi-Fi and the UART interface for Bluetooth communication (SDIO-UART mode)¹. SDIO-UART boot mode is selected by placing a jumper on J13.

 The SDIO interface is accessible through either SD card or M.2 card adapters. The UART interface for Bluetooth can be accessed either directly or via a USB-to-UART bridge. Direct access is provided on pin header J4 or through the UART signals on the M.2 card interface. USB access can be provided through the USB type-C connector J1 or the USB lines on the M.2 card interface. For further information see [Bluetooth host interface](#).

3.5 Host interfaces

The EVB can be connected to a host system with the included SD card or M.2 card adapters. A USB connector is provided to access the Bluetooth UART through a USB-to-UART bridge. For information about the various connection options for each interface, see [SDIO card interface](#), [M.2 card interface](#), and [Bluetooth host interface](#).

¹ SDIO-SDIO is supported by hardware, but not productized in software.

3.5.1 SDIO card interface

Micro SD and full-size SD card adapters are included in the EVK to connect the evaluation board to SDIO capable host sockets. To use one of the SDIO card adapters, connect it with the smaller flat cable to the ZIF connector J3 on the EVB. All SDIO signals are directly connected to the MAYA-W1 module through 22 Ω series resistors. The SDIO interface can be used for power supply of the EVB.

 The SDIO card adapters support only the SDIO interface, which is used for Wi-Fi communication of the MAYA-W1 module. The M.2 card adapter supports additional interfaces, including UART for Bluetooth communication.

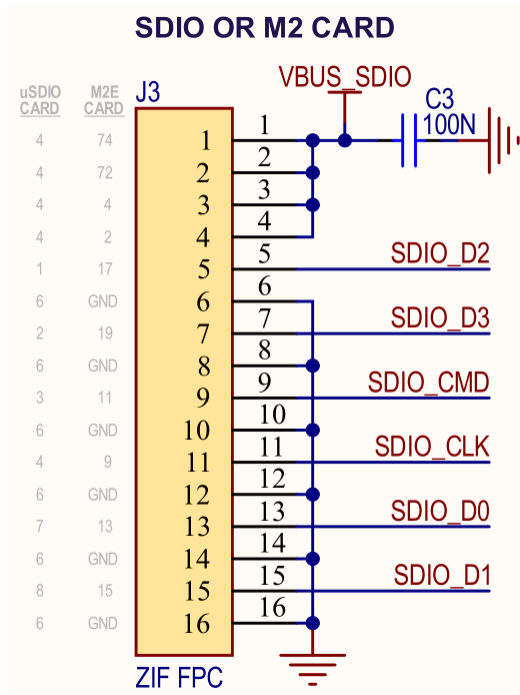

Figure 8: SDIO or M.2 card ZIF connector (J3)

3.5.2 M.2 card interface

An M.2 Key E card adapter is included in the EVK to connect the evaluation board to M.2 Key E host sockets. To use the M.2 adapter, connect it with both flat cables to the matching ZIF connectors J2 and J3 on the EVB.

MAYA-W1 SDIO signals are connected through connector J3. Connector J2 provides additional MAYA-W1 interfaces and signals to the M.2 interface, including UART (optionally through USB), PCM/I2S, JTAG, and other sideband signals. To enable the various interfaces and connect MAYA-W1 signals to connector J2, jumpers must be placed on pin headers J4 and J5. For information about connecting the available MAYA-W1 interfaces to the M.2 card connector, see also Figure 9.

The M.2 interface signals M2_UART_WAKE#, M2_W_DISABLE1#, and M2_W_DISABLE2# use 3.3 V signal voltage with voltage translators on the EVB. See [Schematics](#) for details. All other signals are powered from the board VIO voltage.

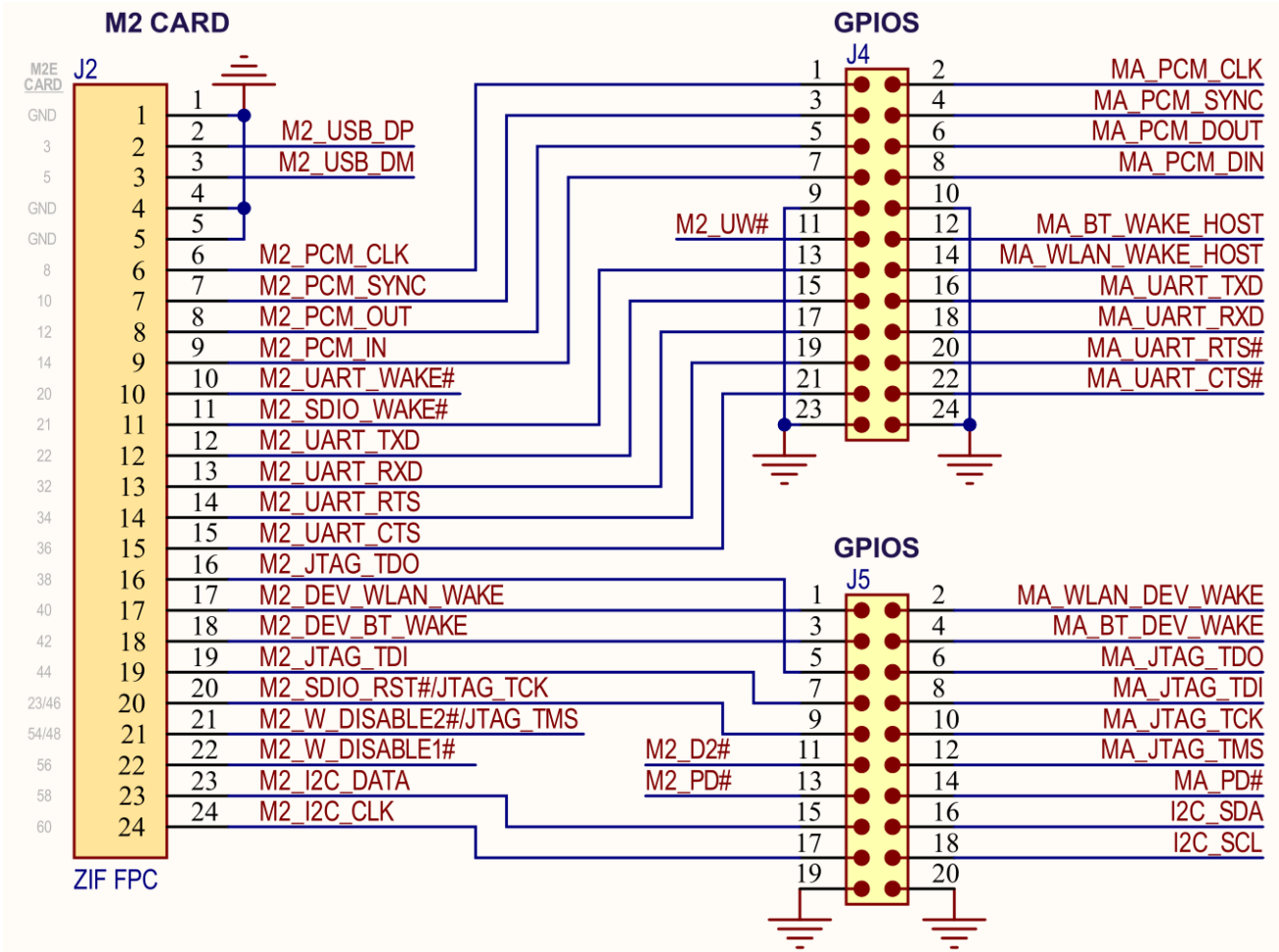

Figure 9: M.2 card ZIF connector (J2) and pin headers J4/5

The M.2 Key E pinout follows the definition from NXP for M.2 sockets on platforms based on NXP MPUs and MCUs. For more information about the Wi-Fi/Bluetooth M.2 Key E Pinout Definition on NXP host boards, see also the NXP AN13049 pin definition [6].



Some interfaces might not be available on the M.2 socket of a host platform. Check the interface connector specification from the host platform vendor to confirm the pinout and supported interfaces.

3.5.3 Bluetooth host interface

MAYA-W1 series provides a UART host interface for Bluetooth communication. The UART interface can be either accessed directly through pin header J4, or connected to the M.2 card connector J2 using jumpers. The EVB includes a USB-to-UART bridge (FT234XD) for accessing the UART interface through USB. Access is provided through the USB type-C connector J1 or the USB lines on the M.2 card interface. The USB type-C connector can be used for the EVB power supply.

The routing and selection of the Bluetooth host interface modes is configured using the jumpers on pin header J6 and J4, as shown in Figure 10 and also Figure 9.

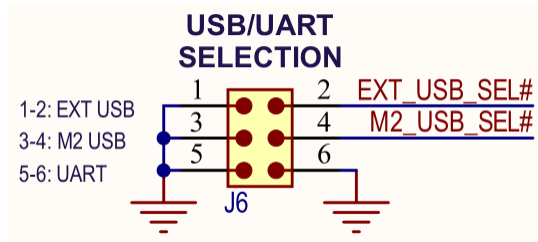

Figure 10: USB/UART selection (J6)

The configuration options for the Bluetooth host interface modes are described in Table 5.

Bluetooth host interface mode	Jumper positions	Description
USB on type-C connector J1	J6: 1-2 (default) J4: UART pins open	The Bluetooth UART interface is available through USB-to-UART bridge on USB type-C connector J1
USB on M.2 connector J2	J6: 3-4 J4: UART pins open	The Bluetooth UART interface is available through USB-to-UART bridge on M.2 card connector J2 (using the USB lines of the M.2 socket)
UART on M.2 connector J2	J6: 5-6 or open J4: UART pins bridged	The Bluetooth UART interface is directly available on M.2 card connector J2 (using the UART lines of the M.2 socket). Jumpers must be placed on J4 to connect the MAYA-W1 UART signal lines to J2.
Direct UART access	J6: 5-6 or open J4: UART pins open	The Bluetooth UART interface is directly available on the UART pins of J4.

Table 5: Bluetooth host interface selection options

3.6 Bluetooth audio interface

For Bluetooth voice applications, MAYA-W1 EVB includes a MAX9860 16-bit audio codec that connects to the PCM/I2S interface of the module. It also includes a 3.5 mm audio jack (J16) for connecting a headset. The MAX9860 codec is driven by 19.2 MHz master clock (MCLK) and is completely controlled through software using an I2C interface. The codec responds to the I2C slave address 0x20 for all write commands and 0x21 for all read operations.

The I2C interface of the audio codec is provided on connector J5, as shown in Table 6. The PCM/I2S interface of the MAYA-W1 module is directly connected to the serial audio interface of the MAX9860 audio codec. The PCM pins are shared with the I2S interface and extend to connector J4, as shown in Table 6.

Name	I/O	Connector / pin no.	Description
I2C_SDA	I/O	J5 / 16	I2C Serial-Data Input/Output
I2C_SCL	I	J5 / 18	I2C Serial-Data clock
PCM_CLK	I/O	J4 / 2	PCM clock Alternate function: I2S clock
PCM_SYNC	I/O	J4 / 4	PCM frame sync Alternate function: I2S word select
PCM_DOUT	O	J4 / 6	PCM data out Alternate function: I2S data out
PCM_DIN	I	J4 / 8	PCM data in Alternate function: I2S data in

Table 6: Audio interfaces

3.7 GPIOs

Figure 9 shows the pin headers J4 and J5 that provide direct access to the UART, JTAG, GPIO and PCM/I2S interfaces on the MAYA-W1 module. The interface signals are connected through jumpers to the M.2 card interface connector J2 or accessed directly through the pin headers.

3.8 Antenna interfaces

The evaluation board of EVK-MAYA-W161 includes two standard 50 Ω female SMA connectors for connecting external antennas or measurement instruments. EVK-MAYA-W166 uses the internal PCB antenna of MAYA-W166.

Table 7 describes the available radio interfaces of the MAYA-W1 module and the respective antenna interfaces on the EVB.

Product name	Module antenna interface	Function	Antenna interface on EVB
EVK-MAYA-W161	RF_ANT0	2.4/5 GHz Wi-Fi	SMA connector J10
	RF_ANT1	Bluetooth	SMA connector J11
EVK-MAYA-W166	Internal PCB antenna	2.4/5 GHz Wi-Fi and Bluetooth	-

Table 7: Antenna interface configuration

 Connect the external antennas supplied with EVK-MAYA-W161 to the SMA connectors J10 and J11. If 2.4 GHz Wi-Fi and Bluetooth are used at the same time, bend the antennas at a 90° angle to each other or use a coaxial RF cable to increase isolation between the antennas.

3.9 Other interfaces

An optional external sleep clock for driving the MAYA-W1 module can be enabled by placing a jumper on J12. Figure 11 shows the module RF control signals and the WCI-2 coexistence interface accessible on J14 and J15.

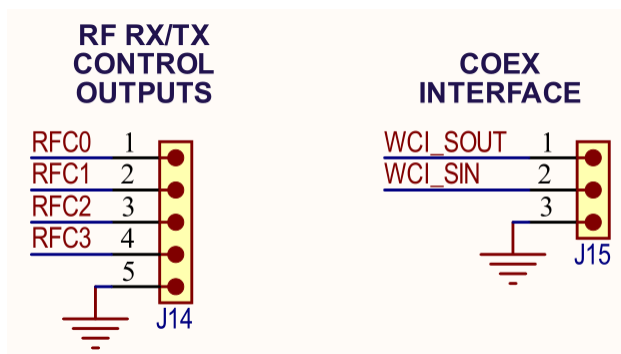

Figure 11: RF controls (J14) and coexistence (J15) interfaces

3.10 LEDs

Table 8 describes the function and designation of the available LEDs on the EVK-MAYA-W1 evaluation board.

Function	Description	Designator	Color
Supply	Board 3.3 V and 1.8 V power supply status indication	D2	Green
UART	UART RX/TX activity indication	D3	Orange

Table 8: LED function

3.11 Reset button

Press the SW1 button on the EVB to reset the MAYA-W1 module. When pressed, SW1 asserts the **PDn** pin of the MAYA-W1 module to enter power down mode, while keeping the supply rails enabled. The module is automatically reset when it exits the power down mode, which means that the firmware must be downloaded again.

3.12 Schematics

Complete schematics for the MAYA-W1 evaluation board are available on request. For further information, [contact](#) your local u-blox support team.

Appendix

A Glossary

Abbreviation	Definition
EVb	Evaluation board
EVK	Evaluation kit
HCI	Host controller interface
I/O	Input / output
I2S	Inter-Integrated circuit sound
LED	Light-Emitting Diode
LDO	Low-dropout regulator
LPO	Low-power oscillator
LTE	Long-Term Evolution
MAC	Medium access control
MIMO	Multiple input multiple output
MMC	Multimedia card
PC	Personal computer
PCI	Peripheral component interconnect
PCIe	Peripheral component interconnect express
PCM	Pulse-code modulation
SD	Secure digital
SDIO	Secure digital input output
UART	Universal asynchronous receiver/transmitter
USB	Universal serial bus
Wi-Fi	Wireless local area network
ZIF	Zero Insertion Force

Table 9: Explanation of the abbreviations and terms used

Related documents

- [1] MAYA-W1 series data sheet, UBX-21006380
 - [2] MAYA-W1 system integration manual, UBX-21010495
 - [3] [Embedded Linux for i.MX Applications Processors](#)
 - [4] [NXP UM11490 - Feature Configuration Guide for NXP-based Wireless Modules on i.MX 8M Quad EVK](#)
 - [5] [MCUXpresso Software Development Kit \(SDK\)](#)
 - [6] [NXP AN13049 - Wi-Fi/Bluetooth M.2 Key E Pinout Definition](#)
-  For product change notifications and regular updates of u-blox documentation, register on our website, www.u-blox.com.

Revision history

Revision	Date	Name	Comments
R01	24-Nov-2021	mzes	Initial release.

Contact

For complete contact information, visit us at www.u-blox.com.

u-blox Offices

North, Central and South America

u-blox America, Inc.

Phone: +1 703 483 3180
E-mail: info_us@u-blox.com

Regional Office West Coast:

Phone: +1 408 573 3640
E-mail: info_us@u-blox.com

Technical Support:

Phone: +1 703 483 3185
E-mail: support_us@u-blox.com

Headquarters

Europe, Middle East, Africa

u-blox AG

Phone: +41 44 722 74 44
E-mail: info@u-blox.com
Support: support@u-blox.com

Asia, Australia, Pacific

u-blox Singapore Pte. Ltd.

Phone: +65 6734 3811
E-mail: info_ap@u-blox.com
Support: support_ap@u-blox.com

Regional Office Australia:

Phone: +61 2 8448 2016
E-mail: info_anz@u-blox.com
Support: support_ap@u-blox.com

Regional Office China (Beijing):

Phone: +86 10 68 133 545
E-mail: info_cn@u-blox.com
Support: support_cn@u-blox.com

Regional Office China (Chongqing):

Phone: +86 23 6815 1588
E-mail: info_cn@u-blox.com
Support: support_cn@u-blox.com

Regional Office China (Shanghai):

Phone: +86 21 6090 4832
E-mail: info_cn@u-blox.com
Support: support_cn@u-blox.com

Regional Office China (Shenzhen):

Phone: +86 755 8627 1083
E-mail: info_cn@u-blox.com
Support: support_cn@u-blox.com

Regional Office India:

Phone: +91 80 405 092 00
E-mail: info_in@u-blox.com
Support: support_in@u-blox.com

Regional Office Japan (Osaka):

Phone: +81 6 6941 3660
E-mail: info_jp@u-blox.com
Support: support_jp@u-blox.com

Regional Office Japan (Tokyo):

Phone: +81 3 5775 3850
E-mail: info_jp@u-blox.com
Support: support_jp@u-blox.com

Regional Office Korea:

Phone: +82 2 542 0861
E-mail: info_kr@u-blox.com
Support: support_kr@u-blox.com

Regional Office Taiwan:

Phone: +886 2 2657 1090
E-mail: info_tw@u-blox.com
Support: support_tw@u-blox.com

单击下面可查看定价，库存，交付和生命周期等信息

[>>U-BLOX\(优北罗\)](#)