

## 1 Features

- Wide Supply Ranges
  - Single Supply: 3 V to 32 V (26 V for LM2902)
  - Dual Supplies:  $\pm 1.5$  V to  $\pm 16$  V ( $\pm 13$  V for LM2902)
- Low Supply-Current Drain Independent of Supply Voltage: 0.8 mA Typical
- Common-Mode Input Voltage Range Includes Ground, Allowing Direct Sensing Near Ground
- Low Input Bias and Offset Parameters
  - Input Offset Voltage: 3 mV Typical
  - Input Offset Current: 2 nA Typical
  - Input Bias Current: 20 nA Typical
- Differential Input Voltage Range Equal to Maximum-Rated Supply Voltage: 32 V (26 V for LM2902)
- Open-Loop Differential Voltage Amplification: 100 V/mV Typical
- Internal Frequency Compensation
- On Products Compliant to MIL-PRF-38535, All Parameters are Tested Unless Otherwise Noted. On All Other Products, Production Processing Does Not Necessarily Include Testing of All Parameters.

## 2 Applications

- Blu-ray Players and Home Theaters
- Chemical and Gas Sensors
- DVD Recorders and Players
- Digital Multimeter: Bench and Systems
- Digital Multimeter: Handhelds
- Field Transmitter: Temperature Sensors
- Motor Control: AC Induction, Brushed DC, Brushless DC, High-Voltage, Low-Voltage, Permanent Magnet, and Stepper Motor
- Oscilloscopes
- TV: LCD and Digital
- Temperature Sensors or Controllers Using Modbus
- Weigh Scales

## 3 Description

These devices consist of four independent high-gain frequency-compensated operational amplifiers that are designed specifically to operate from a single supply or split supply over a wide range of voltages.

Symbol (Each Amplifier)

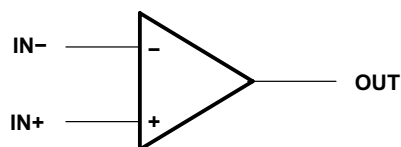

#### 4 Pin Configuration and Functions

DR  
14-Pin SOP, DIP

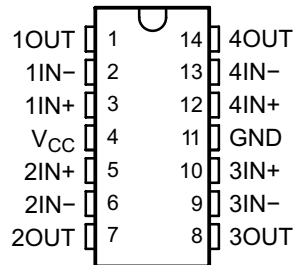

#### Pin Functions

PIN			I/O	DESCRIPTION
NAME	LCCC NO.	SOP, DIP		
1IN-		2	I	Negative input
1IN+		3	I	Positive input
1OUT		1	O	Output
2IN-		6	I	Negative input
2IN+		5	I	Positive input
2OUT		7	O	Output
3IN-		9	I	Negative input
3IN+		10	I	Positive input
3OUT		8	O	Output
4IN-		13	I	Negative input
4IN+		12	I	Positive input
4OUT		14	O	Output
GND		11	—	Ground
V <sub>CC</sub>	6	4	—	Power supply

## 5 Specifications

### 5.1 Absolute Maximum Ratings

over operating free-air temperature range (unless otherwise noted)<sup>(1)</sup>

	LM2902		LM124, LM224		UNIT
	MIN	MAX	MIN	MAX	
Supply voltage, $V_{CC}$ <sup>(2)</sup>	±13	26	±16	32	V
Differential input voltage, $V_{ID}$ <sup>(3)</sup>	±26		±32		V
Input voltage, $V_I$ (either input)	-0.3	26	-0.3	to 32	V
Duration of output short circuit (one amplifier) to ground at (or below) $T_A = 25^\circ\text{C}$ , $V_{CC} \leq 15\text{ V}$ <sup>(4)</sup>	Unlimited		Unlimited		
Operating virtual junction temperature, $T_J$	150		150		°C
Storage temperature, $T_{stg}$	-65	150	-65	150	°C

- (1) Stresses beyond those listed under *Absolute Maximum Ratings* may cause permanent damage to the device. These are stress ratings only, and functional operation of the device at these or any other conditions beyond those indicated under *Recommended Operating Conditions* is not implied. Exposure to absolute-maximum-rated conditions for extended periods may affect device reliability.
- (2) All voltage values (except differential voltages and  $V_{CC}$  specified for the measurement of  $I_{OS}$ ) are with respect to the network GND.
- (3) Differential voltages are at  $IN+$ , with respect to  $IN-$ .
- (4) Short circuits from outputs to  $V_{CC}$  can cause excessive heating and eventual destruction.

### 5.2 ESD

LM124, LM224, LM2902			
$V_{(ESD)}$ Electrostatic discharge	Human-body model (HBM), per ANSI/ESDA/JEDEC JS-001 <sup>(1)</sup>	±500	V
	Charged-device model (CDM), per JEDEC specification JESD22-C101	±1000	

- (1) JEDEC document JEP155 states that 500-V HBM allows safe manufacturing with a standard ESD control process.

### 5.3 Recommended Operating Conditions

over operating free-air temperature range (unless otherwise noted)

	LM2902		LM124, LM224		UNIT
	MIN	MAX	MIN	MAX	
$V_{CC}$ Supply voltage	3	26	3	30	V
$V_{CM}$ Common-mode voltage	0	$V_{CC} - 2$	0	$V_{CC} - 2$	V
$T_A$ Operating free air temperature	LM124		-55	125	°C
	LM2902	-40	105		
	LM224		-20	85	

#### 5.4 Thermal Information

THERMAL METRIC <sup>(1)</sup>	LM124, LM224, LM2902		
	(SOP)	(DIP)	UNIT
	14 PINS	14 PINS	
R <sub>θJA</sub> <sup>(2)(3)</sup> Junction-to-ambient thermal resistance	86	80	°C/W
R <sub>θJC</sub> <sup>(4)</sup> Junction-to-case (top) thermal resistance	—	—	

- (1) Short circuits from outputs to VCC can cause excessive heating and eventual destruction.
- (2) Maximum power dissipation is a function of T<sub>J(max)</sub>, R<sub>θJA</sub>, and T<sub>A</sub>. The maximum allowable power dissipation at any allowable ambient temperature is P<sub>D</sub> = (T<sub>J(max)</sub> - T<sub>A</sub>)/R<sub>θJA</sub>. Operating at the absolute maximum T<sub>J</sub> of 150°C can affect reliability.
- (3) Maximum power dissipation is a function of T<sub>J(max)</sub>, R<sub>θJA</sub>, and T<sub>C</sub>. The maximum allowable power dissipation at any allowable case temperature is P<sub>D</sub> = (T<sub>J(max)</sub> - T<sub>C</sub>)/R<sub>θJC</sub>. Operating at the absolute maximum T<sub>J</sub> of 150°C can affect reliability.

#### 5.5 Electrical Characteristics for LMx24

at specified free-air temperature, V<sub>CC</sub> = 5 V (unless otherwise noted)

PARAMETER	TEST CONDITIONS <sup>(1)</sup>	T <sub>A</sub> <sup>(2)</sup>	LM124, LM224			UNIT
			MIN	TYP <sup>(3)</sup>	MAX	
V <sub>IO</sub> Input offset voltage	V <sub>CC</sub> = 5 V to MAX, V <sub>IC</sub> = V <sub>ICRmin</sub> , V <sub>O</sub> = 1.4 V	25°C	3		5	mV
		Full range	7			
I <sub>IO</sub> Input offset current	V <sub>O</sub> = 1.4 V	25°C	2		30	nA
		Full range	100			
I <sub>IB</sub> Input bias current	V <sub>O</sub> = 1.4 V	25°C	-20		-150	nA
		Full range	-300			
V <sub>ICR</sub> Common-mode input voltage range	V <sub>CC</sub> = 5 V to MAX	25°C	0 to V <sub>CC</sub> - 1.5		V	
		Full range	0 to V <sub>CC</sub> - 2			
V <sub>OH</sub> High-level output voltage	R <sub>L</sub> = 2 kΩ	25°C	V <sub>CC</sub> - 1.5		V	
		25°C	V <sub>CC</sub> - 1.5			
	V <sub>CC</sub> = MAX	R <sub>L</sub> = 2 kΩ	Full range	26		
		R <sub>L</sub> ≥ 10 kΩ	Full range	27 28		
V <sub>OL</sub> Low-level output voltage	R <sub>L</sub> ≤ 10 kΩ	Full range	5 20		mV	
A <sub>VD</sub> Large-signal differential voltage amplification	V <sub>CC</sub> = 15 V, V <sub>O</sub> = 1 V to 11 V, R <sub>L</sub> ≥ 2 kΩ	25°C	50 100		V/mV	
		Full range	25			
CMRR Common-mode rejection ratio	V <sub>IC</sub> = V <sub>ICRmin</sub>	25°C	70 80		dB	
k <sub>SVR</sub> Supply-voltage rejection ratio (ΔV <sub>CC</sub> /ΔV <sub>IO</sub> )		25°C	65 100		dB	
V <sub>O1</sub> /V <sub>O2</sub> Crosstalk attenuation	f = 1 kHz to 20 kHz	25°C	120		dB	
I <sub>O</sub> Output current	V <sub>CC</sub> = 15 V, V <sub>ID</sub> = 1 V, V <sub>O</sub> = 0	Source	25°C	-20 -30 -60		mA
			Full range	-10		
	V <sub>CC</sub> = 15 V, V <sub>ID</sub> = -1 V, V <sub>O</sub> = 15 V	Sink	25°C	10 20		
			Full range	5		
	V <sub>ID</sub> = -1 V, V <sub>O</sub> = 200 mV	25°C	12 30		μA	
I <sub>OS</sub> Short-circuit output current	V <sub>CC</sub> at 5 V, V <sub>O</sub> = 0, GND at -5 V	25°C	±40 ±60		mA	
I <sub>CC</sub> Supply current (four amplifiers)	V <sub>O</sub> = 2.5 V, no load	Full range	0.7 1.2		mA	
	V <sub>CC</sub> = MAX, V <sub>O</sub> = 0.5 V <sub>CC</sub> , no load	Full range	1.4 3			

- (1) All characteristics are measured under open-loop conditions, with zero common-mode input voltage, unless otherwise specified. MAX V<sub>CC</sub> for testing purposes is 26 V for LM2902 and 30 V for the others.
- (2) Full range is -55°C to 125°C for LM124, -20°C to 85°C for LM224
- (3) All typical values are at T<sub>A</sub> = 25°C

## 5.6 Operating Conditions

$V_{CC} = \pm 15\text{ V}$ ,  $T_A = 25^\circ\text{C}$

PARAMETER		TEST CONDITIONS	TYP	UNIT
SR	Slew rate at unity gain	$R_L = 1\text{ M}\Omega$ , $C_L = 30\text{ pF}$ , $V_I = \pm 10\text{ V}$ (see Figure 7)	0.5	V/ $\mu$ s
$B_1$	Unity-gain bandwidth	$R_L = 1\text{ M}\Omega$ , $C_L = 20\text{ pF}$ (see Figure 7)	1.2	MHz
$V_n$	Equivalent input noise voltage	$R_S = 100\ \Omega$ , $V_I = 0\text{ V}$ , $f = 1\text{ kHz}$ (see Figure 8)	35	nV/ $\sqrt{\text{Hz}}$

5.7 Typical Characteristics

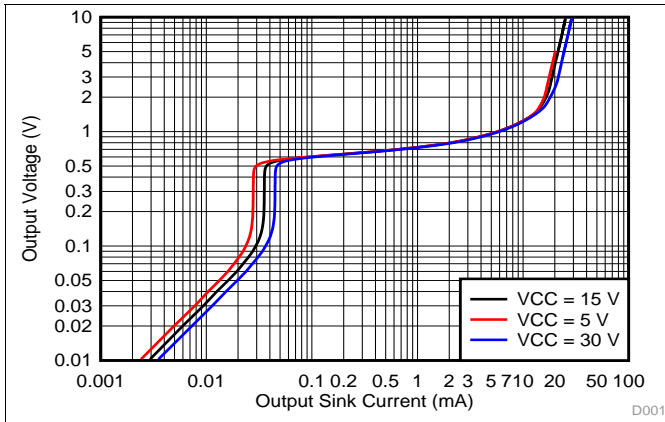

Figure 1. Output Sinking Characteristics

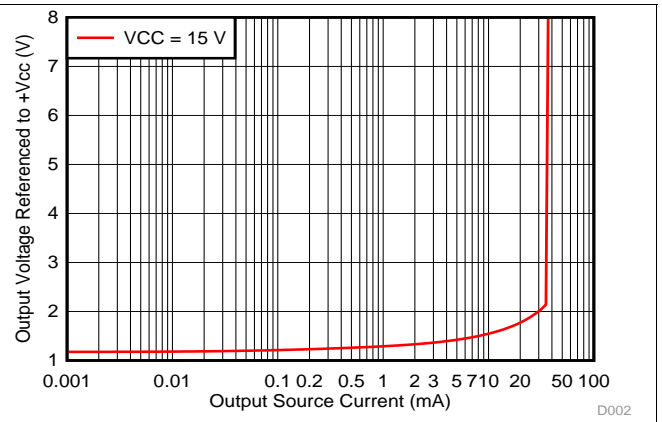

Figure 2. Output Sourcing Characteristics

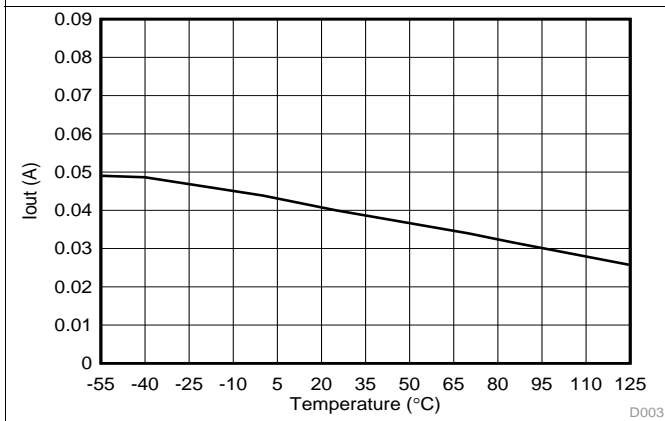

Figure 3. Source Current Limiting

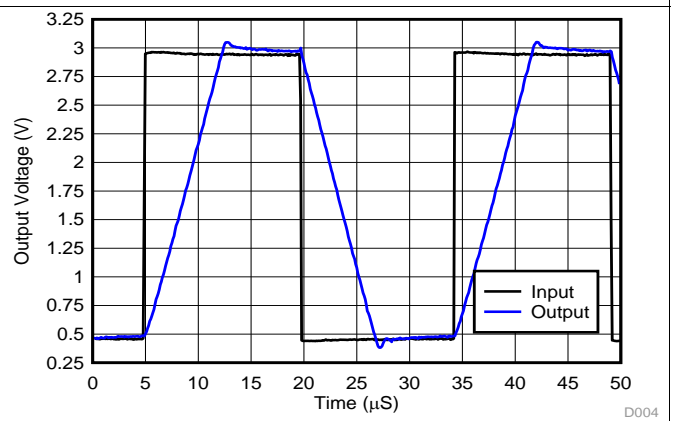

Figure 4. Voltage Follower Large Signal Response (50 pF)

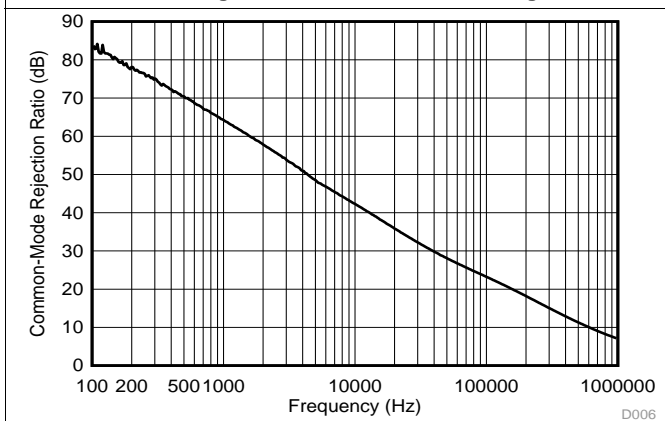

Figure 5. Common-Mode Rejection Ratio

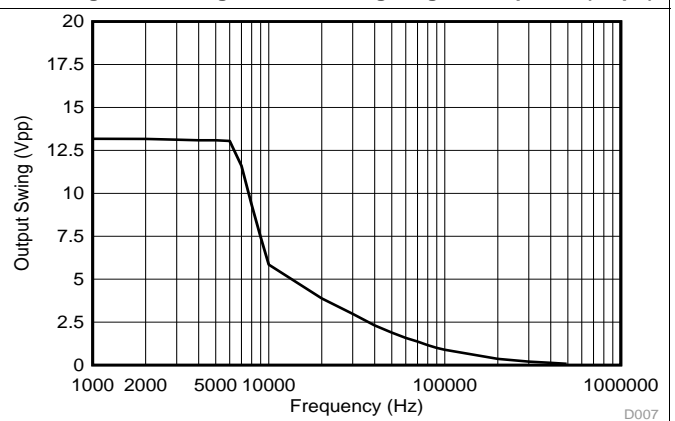

Figure 6. Maximum Output Swing vs. Frequency (VCC = 15 V)

## 6 Parameter Measurement Information

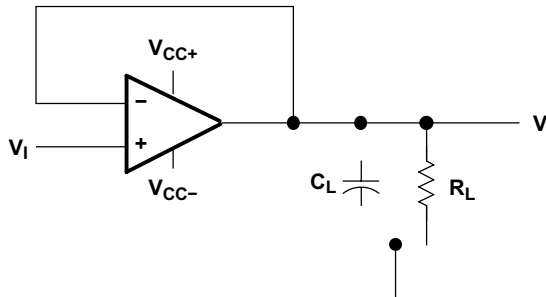

Figure 7. Unity-Gain Amplifier

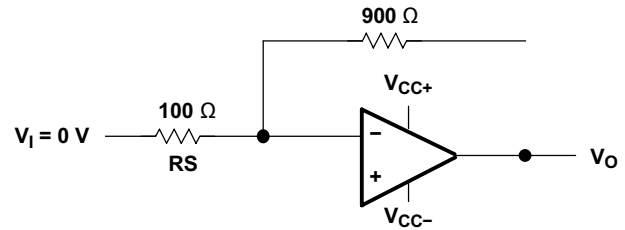

Figure 8. Noise-Test Circuit

## 7 Detailed Description

### 7.1 Overview

These devices consist of four independent high-gain frequency-compensated operational amplifiers that are designed specifically to operate from a single supply over a wide range of voltages. Operation from split supplies also is possible if the difference between the two supplies is 3 V to 32 V (3 V to 26 V for the LM2902 device), and  $V_{CC}$  is at least 1.5 V more positive than the input common-mode voltage. The low supply-current drain is independent of the magnitude of the supply voltage.

Applications include transducer amplifiers, DC amplification blocks, and all the conventional operational-amplifier circuits that now can be more easily implemented in single-supply-voltage systems. For example, the LM124 device can be operated directly from the standard 5-V supply that is used in digital systems and provides the required interface electronics, without requiring additional  $\pm 15$ -V supplies.

7.2 Functional Block Diagram

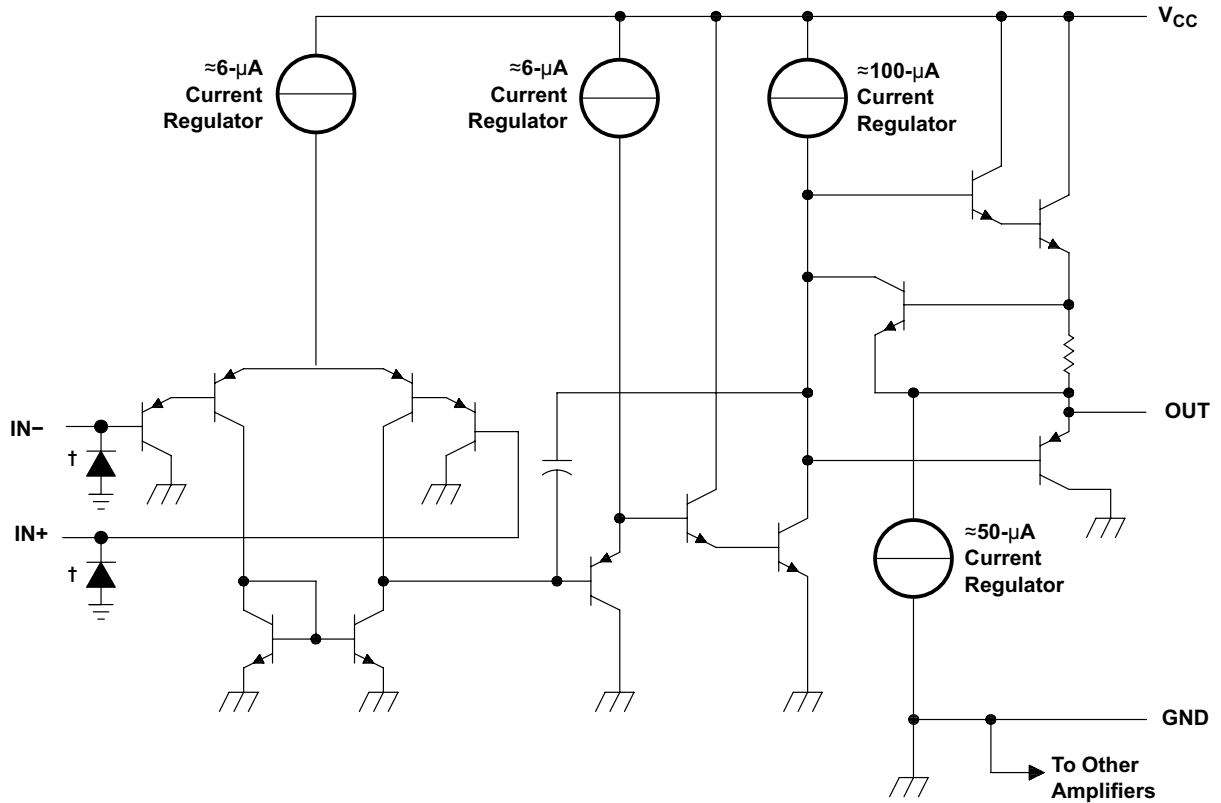

COMPONENT COUNT (total device)	
Epi-FET	1
Transistors	95
Diodes	4
Resistors	11
Capacitors	4



#### PACKAGE

##### SOP14

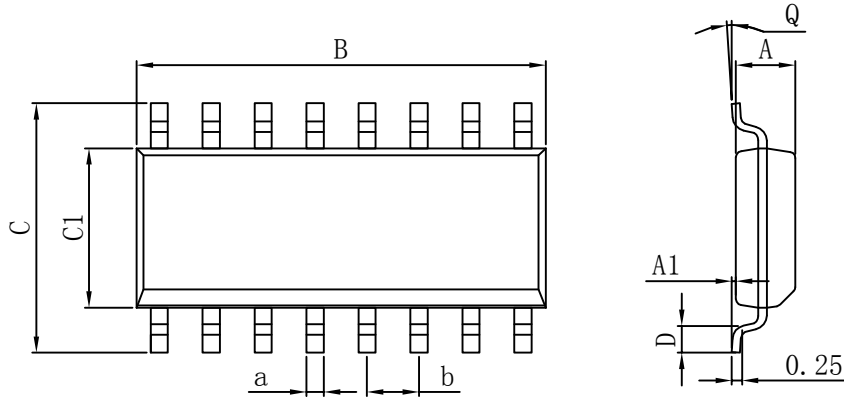

UNIT: mm

DIM.	MIN	TYP	MAX	DIM.	MIN	TYP	MAX
A	4.520	4.570	4.620	a	0.400	0.420	0.440
A1	0.100	-	0.250	b	1.260	1.270	1.280
B	8.500	8.750	9.000	Q	0°	-	8°
C	5.800	6.100	6.250				
C1	3.800	3.900	4.000				
D	0.400	-	0.950				

##### DIP14

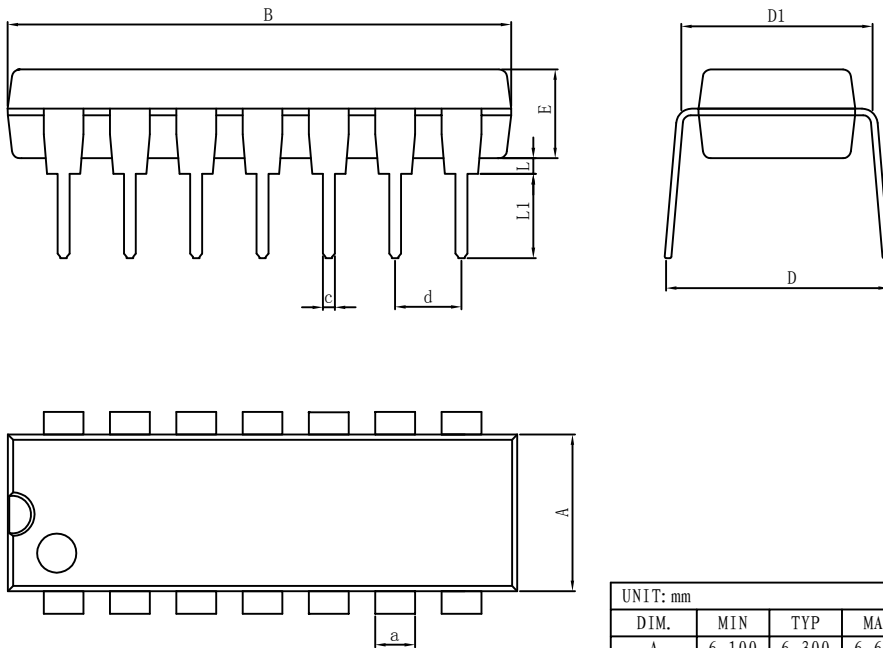

UNIT: mm

DIM.	MIN	TYP	MAX	DIM.	MIN	TYP	MAX
A	6.100	6.300	6.680	a	1.504	1.524	1.544
B	18.940	19.200	19.560	c	0.437	0.457	0.477
D	8.200	8.700	9.200	d	2.530	2.540	2.550
D1	7.42	7.62	7.82	L	0.500	-	0.800
E	3.100	3.300	3.550	L1	3.000	3.200	3.600

单击下面可查看定价，库存，交付和生命周期等信息

[>>UDF\(优迪半导体\)](#)