

OFFICE MACHINE
 PROGRAMMABLE CONTROLLERS
 AC/DC-INPUT MODULE
 TELECOMMUNICATION

The MINI FLAT COUPLER TLP181 is a small outline coupler, suitable for surface mount assembly. TLP181 consist of a photo transistor optically coupled to a gallium arsenide infrared emitting diode in a four lead plastic DIP package.

- Collector-Emitter Voltage : 80V (Min.)
- Current Transfer Ratio : 50% (Min.)
 Rank GB : 100% (Min.)
- Isolation Voltage : 3750V_{rms} (Min.)
- UL Recognized : UL1577, File No. E492440

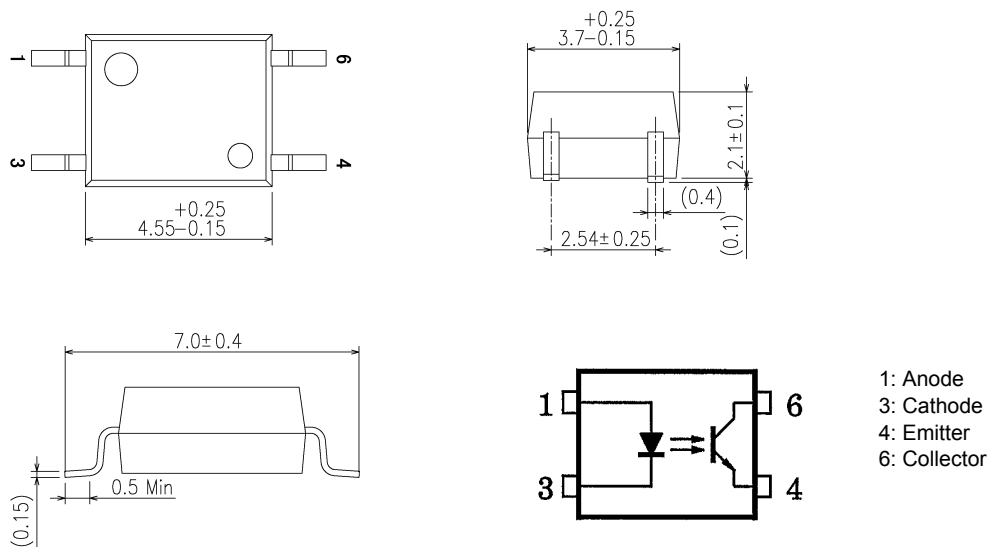

CURRENT TRANSFER RATIO

TYPE	CLASSI- FICATION *1	CURRENT TRANSFER RATIO (%)		MARKING OF CLASSIFICATION
		(I_C / I_F)		
		$I_F = 5\text{mA}, V_{CE} = 5\text{V}, T_a = 25^\circ\text{C}$		
		MIN.	MAX.	
TLP181	(None)	50	600	BLANK, Y, Y [■] , G, G [■] , B, B [■] , GB
	Rank Y	50	150	Y, Y [■]
	Rank GR	100	300	G, G [■]
	Rank BL	200	600	B, B [■]
	Rank GB	100	600	G, G [■] , B, B [■] , GB

*1 : EX, Rank GB : TLP181GB

MAXIMUM RATINGS (Ta = 25°C)

CHARACTERISTIC		SYMBOL	RATING	UNIT
ED	Forward Current	I _F	50	mA
	Forward Current Detating	ΔI _F /°C	-0.7 (Ta ≥ 53°C)	mA/°C
	Pulse Forward Current	I _{FP}	1 (100μs pulse, 100pps)	A
	Reverse Voltage	V _R	5	V
	Junction Temperature	T _j	125	°C
DETECTOR	Collector-Emitter Voltage	V _{CEO}	80	V
	Emitter-Collector Voltage	V _{ECO}	7	V
	Collector Current	I _C	50	mA
	Collector Power Dissipation (1 Circuit)	P _C	150	mW
	Collector Power Dissipation Derating (1 Circuit Ta ≥ 25°C)	ΔP _C /°C	-1.5	mW/°C
	Junction Temperature	T _j	125	°C
Storage Temperature Range		T _{stg}	-55~125	°C
Operating Temperature Range		T _{opr}	-55~100	°C
Lead Soldering Temperature		T _{sol}	260 (10s)	°C
Total Package Power Dissipation		P _T	200	mW
Total Package Power Dissipation Derating (Ta ≥ 25°C)		ΔP _T /°C	-2.0	mW/°C
Isolation Voltage (Note 1)		BV _S	3750 (AC, 1min., RH ≤ 60%)	V _{rms}

Note 1 Device considered a two-terminal device : Pin 1, 3 shorted together and pins 4, 6 shorted together

INDIVIDUAL ELECTRICAL CHARACTERISTICS (Ta = 25°C)

	CHARACTERISTIC	SYMBOL	TEST CONDITION	MIN.	TYP.	MAX.	UNIT
LED	Forward Voltage	V_F	$I_F = 10\text{mA}$	1.0	1.15	1.3	V
	Reverse Current	I_R	$V_R = 5\text{V}$	—	—	10	μA
	Capacitance	C_T	$V = 0, f = 1\text{MHz}$	—	30	—	pF
ELECTOR	Collector-Emitter Breakdown Voltage	$V_{(BR)CEO}$	$I_C = 0.5\text{mA}$	80	—	—	V
	Emitter-Collector Breakdown Voltage	$V_{(BR)ECO}$	$I_E = 0.1\text{mA}$	7	—	—	V
	Collector Dark Current	I_{CEO}	$V_{CE} = 48\text{V}$, (Ambient Light Below 1000 lx)	—	0.01 (2)	0.1 (10)	μA
			$V_{CE} = 48\text{V}$, $T_a = 85^\circ\text{C}$, (Ambient Light Below 1000 lx)	—	2 (4)	50 (50)	μA
Capacitance (Collector to Emitter)	C_{CE}	$V = 0, f = 1\text{MHz}$	—	10	—	pF	

COUPLED ELECTRICAL CHARACTERISTICS (Ta = 25°C)

	CHARACTERISTIC	SYMBOL	TEST CONDITION	MIN.	TYP.	MAX.	UNIT
Current Transfer Ratio	I_C / I_F	$I_F = 5\text{mA}, V_{CE} = 5\text{V}$ Rank GB	50	—	600	%	
			100	—	600		
Saturated CTR	$I_C / I_F (\text{sat})$	$I_F = 1\text{mA}, V_{CE} = 0.4\text{V}$ Rank GB	—	60	—	%	
			30	—	—		
Collector-Emitter Saturation Voltage	$V_{CE} (\text{sat})$	$I_C = 2.4\text{mA}, I_F = 8\text{mA}$ $I_C = 0.2\text{mA}, I_F = 1\text{mA}$ Rank GB	—	—	0.4	V	
			—	0.2	—		
			—	—	0.4		
Off-State Collector Current	$I_C (\text{off})$	$V_F = 0.7\text{V}, V_{CE} = 48\text{V}$	—	1	10	μA	

ISOLATION CHARACTERISTICS (Ta = 25°C)

	CHARACTERISTIC	SYMBOL	TEST CONDITION	MIN.	TYP.	MAX.	UNIT
Capacitance (Input to Output)	C_S	$V_S = 0\text{V}, f = 1\text{MHz}$	—	0.8	—	pF	
Isolation Resistance	R_S	$V_S = 500\text{V}$	5×10^{10}	10^{14}	—	Ω	
Isolation Voltage	BV_S	AC, 1 minute	3750	—	—	V_{rms}	
		AC, 1 second, in oil	—	10000	—		
		DC, 1 minute, in oil	—	10000	—	V_{dc}	

SWITCHING CHARACTERISTICS (Ta = 25°C)

CHARACTERISTIC	SYMBOL	TEST CONDITION	MIN.	TYP.	MAX.	UNIT
Rise Time	t_r	$V_{CC} = 10V, I_C = 2mA$ $R_L = 100\Omega$	—	2	—	μs
Fall Time	t_f		—	3	—	
Turn-on Time	t_{on}		—	3	—	
Turn-off Time	t_{off}		—	3	—	
Turn-on Time	t_{ON}	$R_L = 1.9k\Omega$ (Fig.1) $V_{CC} = 5V, I_F = 16mA$	—	2	—	μs
Storage Time	t_s		—	25	—	
Turn-off Time	t_{OFF}		—	40	—	

RECOMMENDED OPERATING CONDITIONS

CHARACTERISTIC	SYMBOL	MIN.	TYP.	MAX.	UNIT
Supply Voltage	V_{CC}	—	5	48	V
Forward Current	I_F	—	16	20	mA
Collector Current	I_C	—	1	10	mA
Operating Temperature	T_{opr}	-25	—	85	°C

Fig.1 SWITCHING TIME TEST CIRCUIT

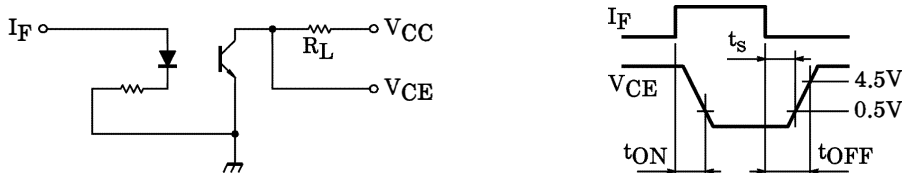

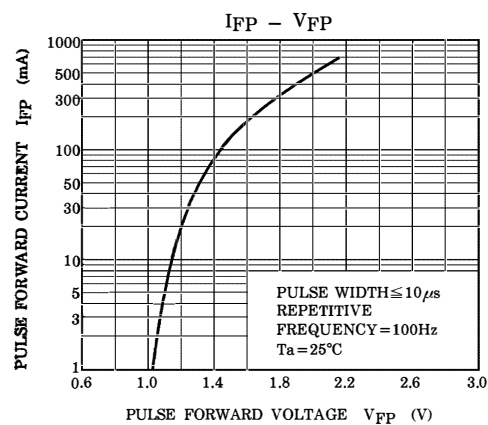
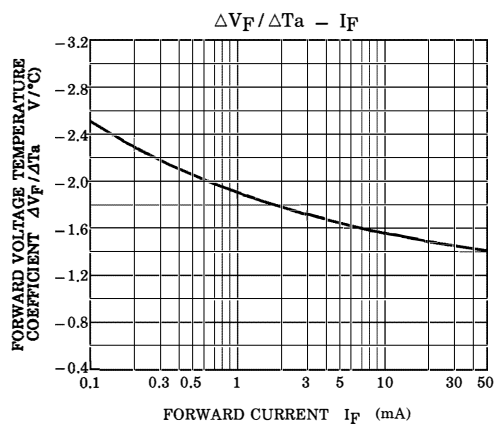
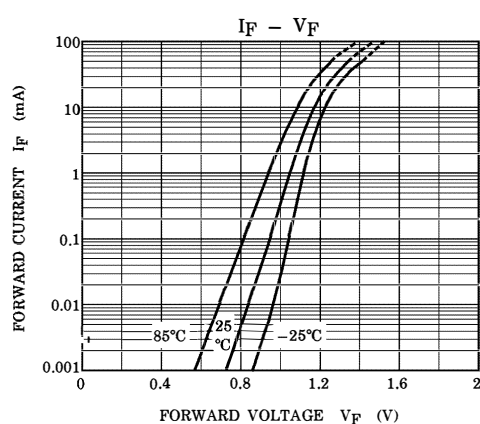
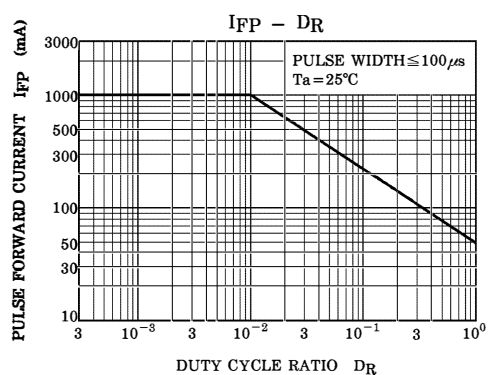
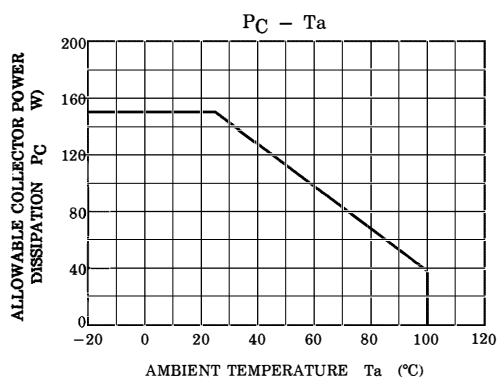
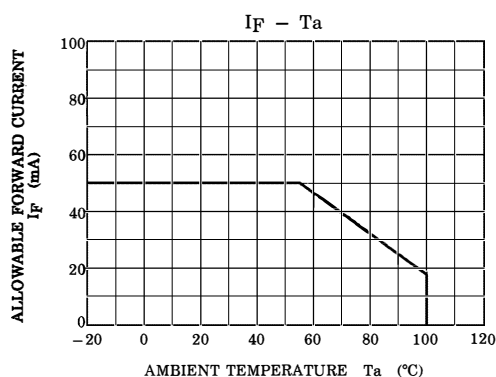

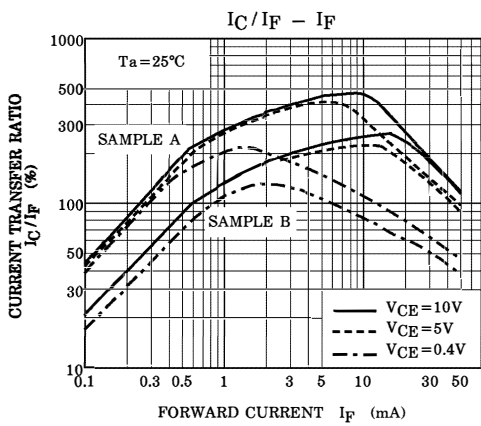
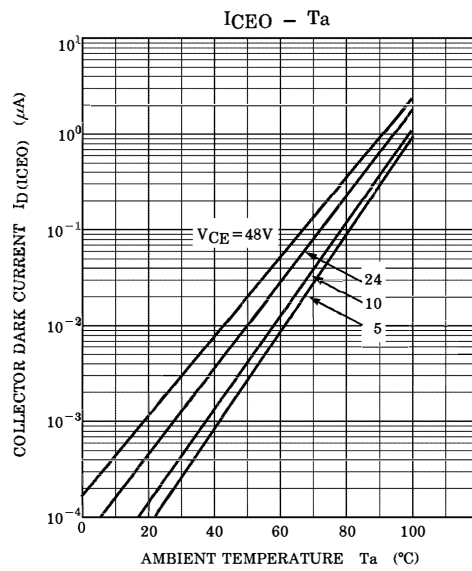
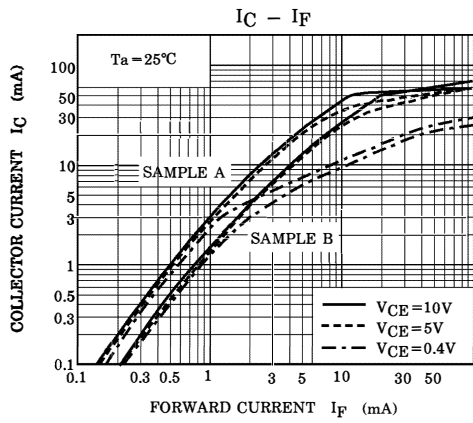
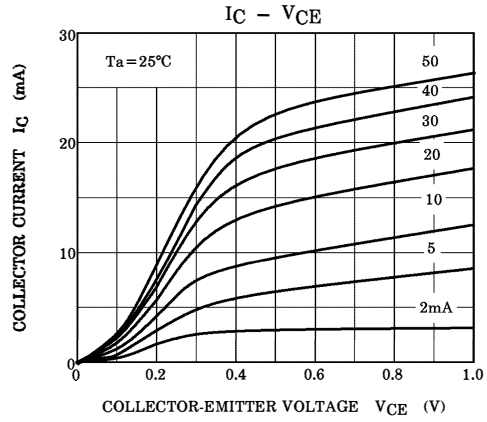
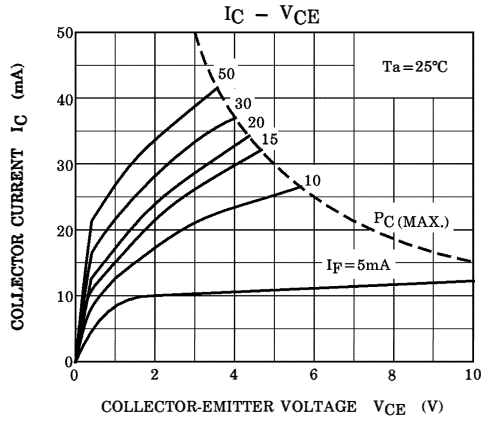

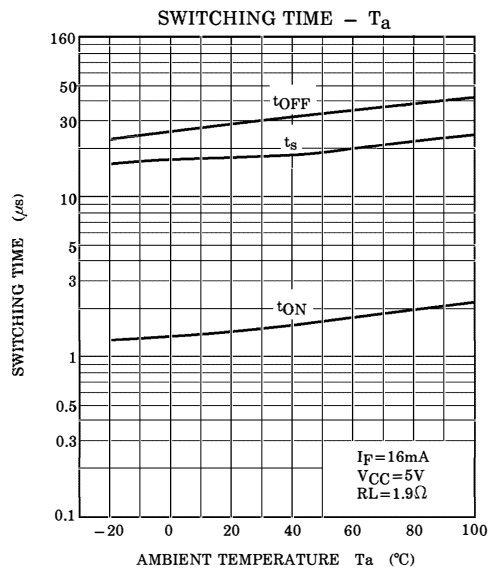
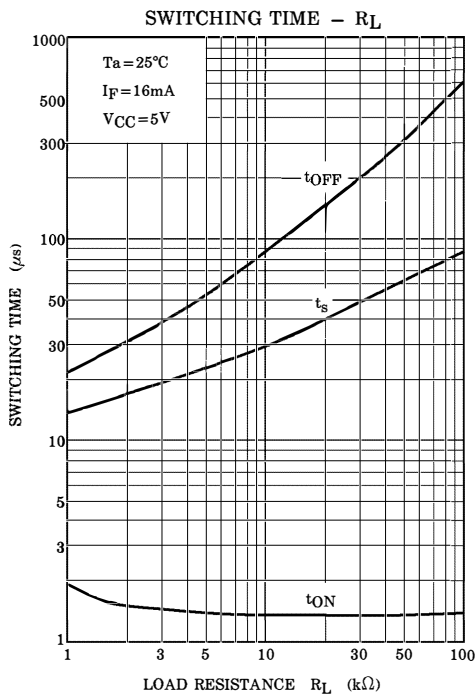
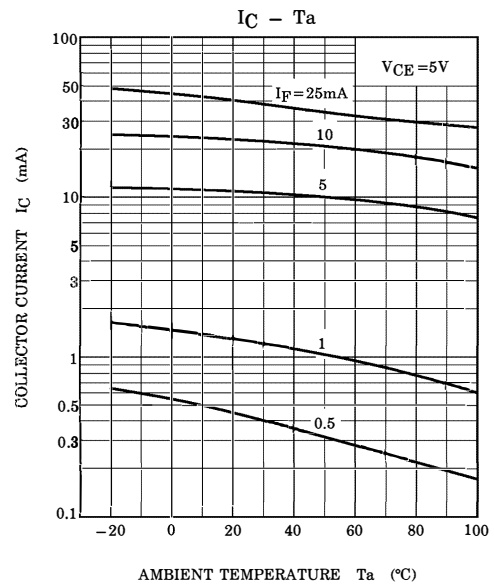
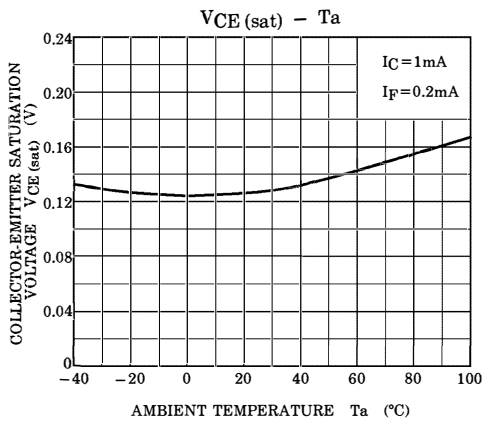

单击下面可查看定价，库存，交付和生命周期等信息

[>>UDF\(优迪半导体\)](#)