

■ Features

- $V_{DS} (V) = 60V$
- $I_D = 3 A (V_{GS} = 10V)$
- $R_{DS(ON)} < 80m\Omega (V_{GS} = 10V), I_D=3A$
- $R_{DS(ON)} < 95m\Omega (V_{GS} = 4.5V), I_D=1.9A$

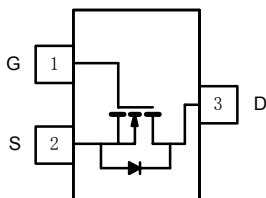
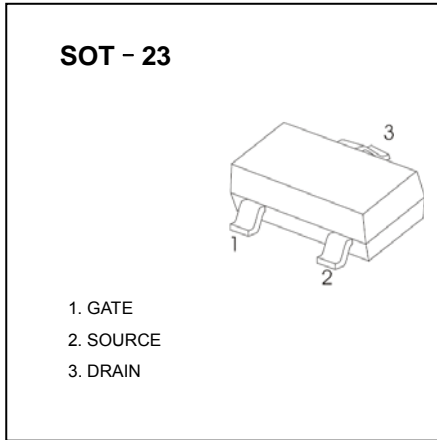

■ Absolute Maximum Ratings  $T_a = 25^\circ C$

Parameter	Symbol	Rating	Unit	
Drain-Source Voltage	$V_{DS}$	60	V	
Gate-Source Voltage	$V_{GS}$	$\pm 20$		
Continuous Drain Current	$I_D$	$T_a=25^\circ C$	3	A
		$T_a=70^\circ C$	1.9	
Pulsed Drain Current	$I_{DM}$	10		
Power Dissipation	$P_D$	$T_a=25^\circ C$	1.25	W
		$T_a=70^\circ C$	0.8	
Thermal Resistance.Junction- to-Ambient	$R_{thJA}$	(Note.1)	100	$^\circ C/W$
		(Note.2)	166	
Junction Temperature	$T_J$	150	$^\circ C$	
Storage Temperature Range	$T_{stg}$	-55 to 150		

Note.1: Surface Mounted on FR4 Board,  $t \leq 5 \text{ sec.}$

Note.2: Surface Mounted on FR4 Board

## ■ Electrical Characteristics Ta = 25°C

Parameter	Symbol	Test Conditions	Min	Typ	Max	Unit
Drain-Source Breakdown Voltage	V <sub>DSS</sub>	I <sub>D</sub> =250 μA, V <sub>GS</sub> =0V	60			V
Zero Gate Voltage Drain Current	I <sub>DSS</sub>	V <sub>DS</sub> =60V, V <sub>GS</sub> =0V			0.5	μA
		V <sub>DS</sub> =60V, V <sub>GS</sub> =0V, T <sub>J</sub> =55°C			10	
Gate-Body Leakage Current	I <sub>GSS</sub>	V <sub>DS</sub> =0V, V <sub>GS</sub> =±20V			±100	nA
Gate Threshold Voltage	V <sub>GS(th)</sub>	V <sub>DS</sub> =V <sub>GS</sub> , I <sub>D</sub> =250 μA	1		3	V
Static Drain-Source On-Resistance	R <sub>DS(on)</sub>	V <sub>GS</sub> =10V, I <sub>D</sub> =3A			80	mΩ
		V <sub>GS</sub> =4.5V, I <sub>D</sub> =1.9A			95	
On State Drain Current	I <sub>D(on)</sub>	V <sub>GS</sub> ≥4.5V, V <sub>DS</sub> =10V	6			A
		V <sub>GS</sub> ≥4.5V, V <sub>DS</sub> =4.5V	4			
Forward Transconductance	g <sub>FS</sub>	V <sub>DS</sub> =4.5V, I <sub>D</sub> =2A		4.6		S
Input Capacitance	C <sub>iss</sub>	V <sub>GS</sub> =0V, V <sub>DS</sub> =25V, f=1MHz		240		pF
Output Capacitance	C <sub>oss</sub>			50		
Reverse Transfer Capacitance	C <sub>rss</sub>			15		
Gate Resistance	R <sub>g</sub>	V <sub>GS</sub> =0V, V <sub>DS</sub> =0V, f=1MHz	0.5		3.3	Ω
Total Gate Charge	Q <sub>g</sub>	V <sub>GS</sub> =10V, V <sub>DS</sub> =30V, I <sub>D</sub> =2A		4.8	10	nC
Gate Source Charge	Q <sub>gs</sub>			0.8		
Gate Drain Charge	Q <sub>gd</sub>			1		
Turn-On DelayTime	t <sub>d(on)</sub>	V <sub>GS</sub> =4.5V, V <sub>DS</sub> =30V, I <sub>D</sub> =1A, R <sub>L</sub> =30Ω, R <sub>G</sub> =6Ω		7	15	ns
Turn-On Rise Time	t <sub>r</sub>			10	20	
Turn-Off DelayTime	t <sub>d(off)</sub>			17	35	
Turn-Off Fall Time	t <sub>f</sub>			6	15	
Maximum Body-Diode Continuous Current	I <sub>S</sub>				1	A
Diode Forward Voltage	V <sub>SD</sub>	I <sub>S</sub> =1A, V <sub>GS</sub> =0V			1.2	V

Note. Pulse test; pulse width ≤ 300 us, duty cycle ≤ 2%.

■ Typical Characteristics

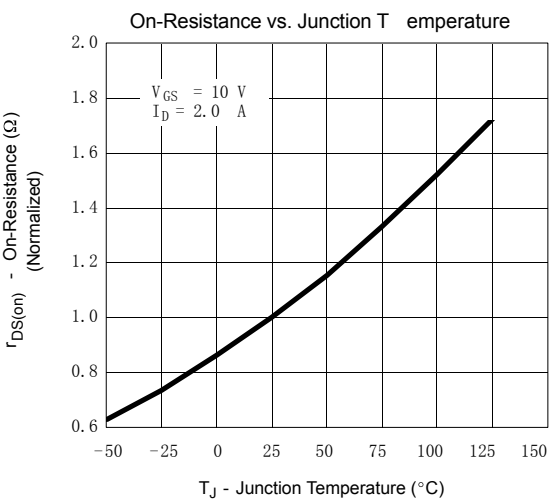
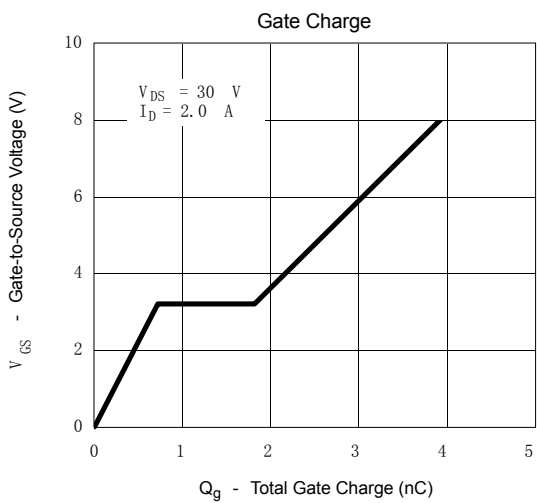
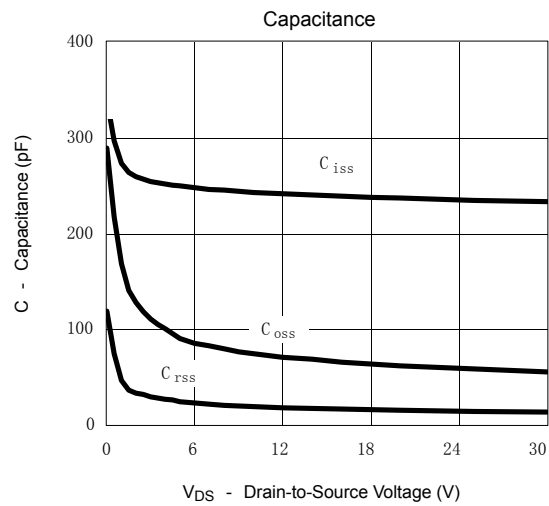
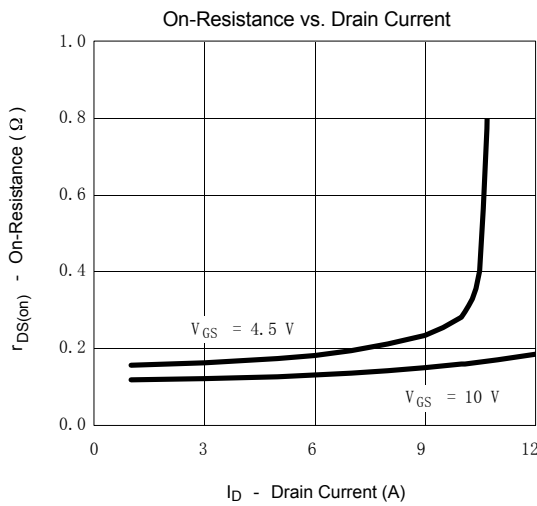
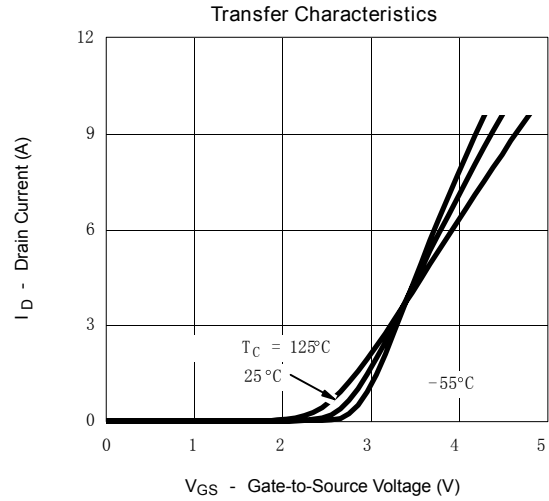
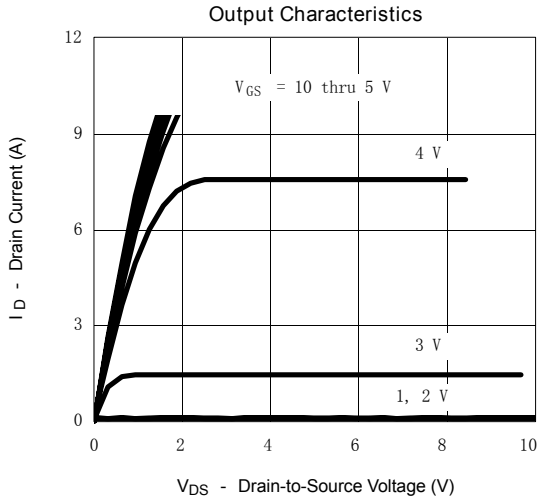

■ Typical Characteristics

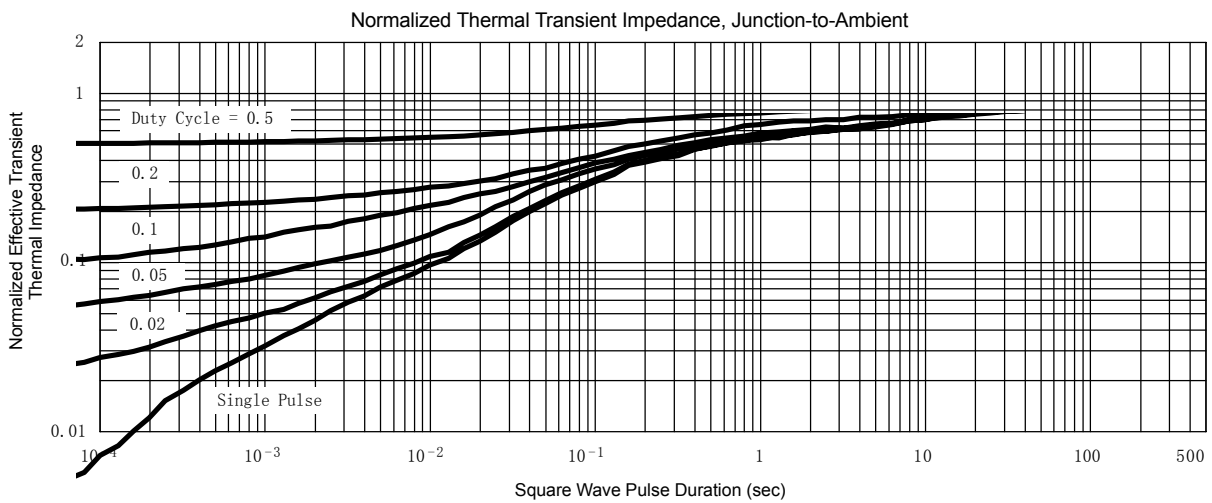
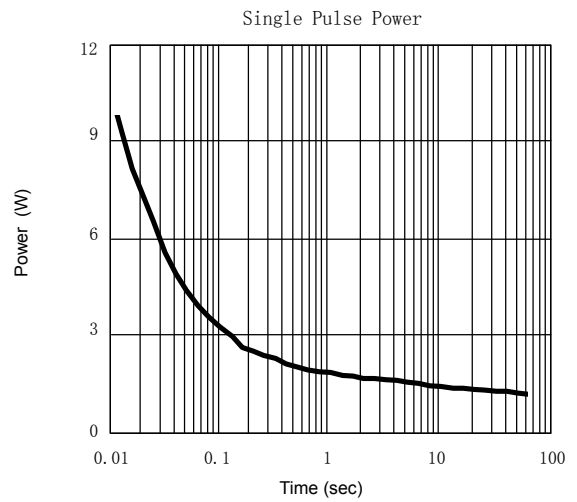
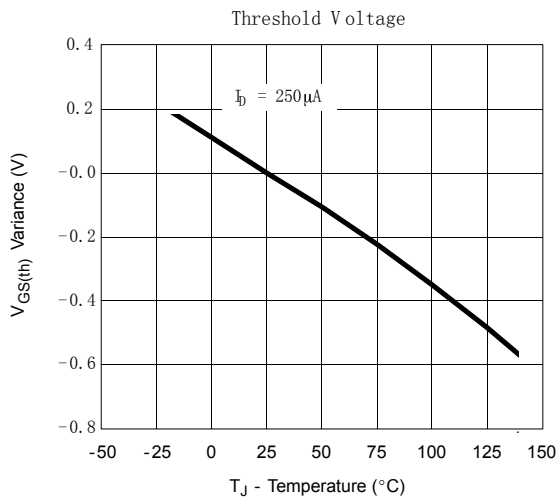
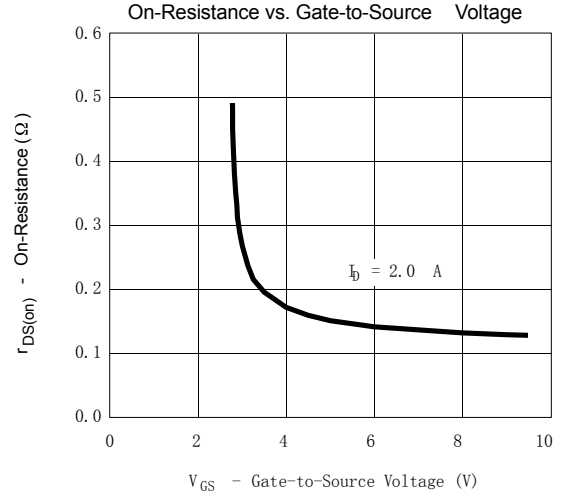
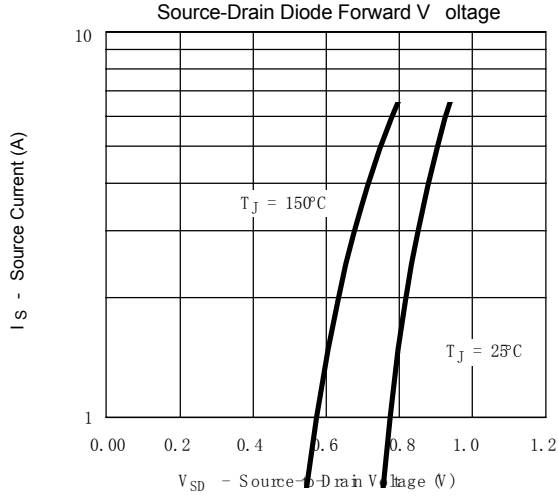

SOT-23 PACKAGE OUTLINE DIMENSIONS

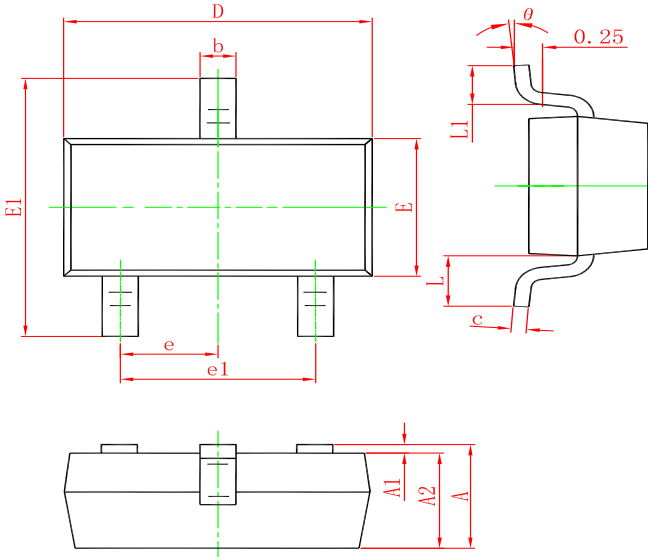

Symbol	Dimensions In Millimeters		Dimensions In Inches	
	Min.	Max.	Min.	Max.
A	0.900	1.150	0.035	0.045
A1	0.000	0.100	0.000	0.004
A2	0.900	1.050	0.035	0.041
b	0.300	0.500	0.012	0.020
c	0.080	0.150	0.003	0.006
D	2.800	3.000	0.110	0.118
E	1.200	1.400	0.047	0.055
E1	2.250	2.550	0.089	0.100
e	0.950 TYP.		0.037 TYP.	
e1	1.800	2.000	0.071	0.079
L	0.550 REF.		0.022 REF.	
L1	0.300	0.500	0.012	0.020
theta	0°	8°	0°	8°

Marking

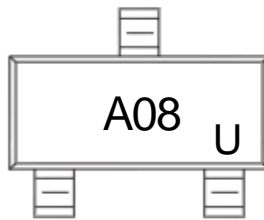

Ordering information

Order code	Package	Baseqty	Deliverymode
SI2308A	SOT-23	3000	Tape and reel

单击下面可查看定价，库存，交付和生命周期等信息

[>>UDF\(优迪半导体\)](#)