

■ Features

- $V_{DS} (V) = 50V$
- $I_D = 300\text{ mA} (V_{GS} = 10V)$
- $R_{DS(ON)} < 2.5\ \Omega (V_{GS} = 10V)$
- $R_{DS(ON)} < 3.5\ \Omega (V_{GS} = 2.5V)$
- Low On-Resistance
- ESD Rating: 1.5KV HBM

MARKING

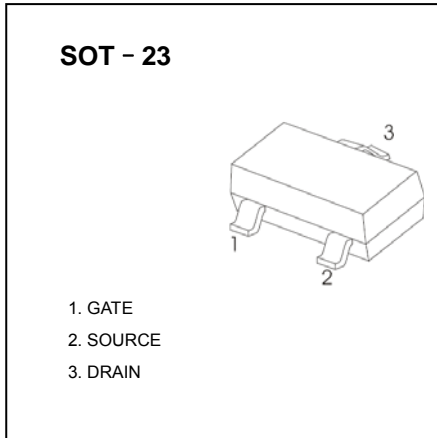
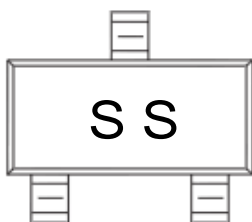

■ Absolute Maximum Ratings $T_a = 25^\circ C$

Parameter	Symbol	Rating	Unit
Drain-Source Voltage	V_{DS}	50	V
Drain-Gate Voltage $R_{GS} \leq 20K\Omega$	V_{DG}	50	
Gate-Source Voltage	V_{GS}	± 20	
Continuous Drain Current	I_D	300	mA
Power Dissipation	P_D	300	mW
Thermal Resistance.Junction- to-Ambient	R_{thJA}	417	$^\circ C/W$
Junction Temperature	T_J	150	$^\circ C$
Storage Temperature Range	T_{stg}	-55 to 150	

■ Electrical Characteristics $T_a = 25^\circ C$

Parameter	Symbol	Test Conditions	Min	Typ	Max	Unit
Drain-Source Breakdown Voltage	V_{DSS}	$I_D=250\ \mu A, V_{GS}=0V$	50			V
Zero Gate Voltage Drain Current	I_{DSS}	$V_{DS}=50V, V_{GS}=0V$			0.5	μA
Gate-Body Leakage Current	I_{GSS}	$V_{DS}=0V, V_{GS}=\pm 20V$			± 10	μA
Gate Threshold Voltage	$V_{GS(th)}$	$V_{DS}=V_{GS}, I_D=250\ \mu A$	0.7		1.5	V
Static Drain-Source On-Resistance	$R_{DS(on)}$	$V_{GS}=10V, I_D=500mA$			2.5	Ω
		$V_{GS}=2.5V, I_D=500mA$			3.5	
Forward Transconductance	g_{FS}	$V_{DS}=25V, I_D=0.3A, f=1KHz$	100			mS
Input Capacitance	C_{iss}	$V_{GS}=0V, V_{DS}=10V, f=1MHz$			50	pF
Output Capacitance	C_{oss}				25	
Reverse Transfer Capacitance	C_{rss}				8	
Turn-On DelayTime	$t_{d(on)}$	$V_{DS}=30V, I_D=0.3A, R_G=50\ \Omega$			20	ns
Turn-Off DelayTime	$t_{d(off)}$				20	

■ Typical Characteristics

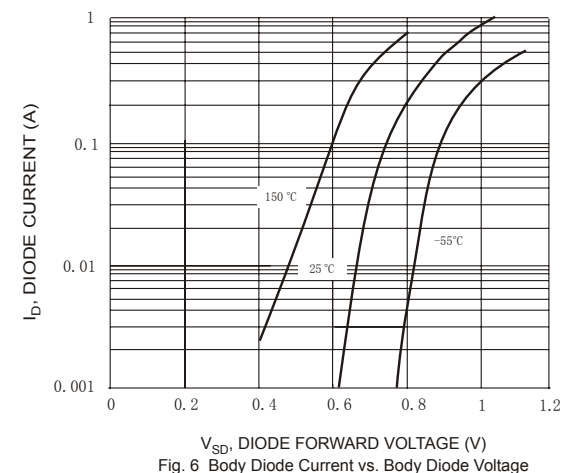
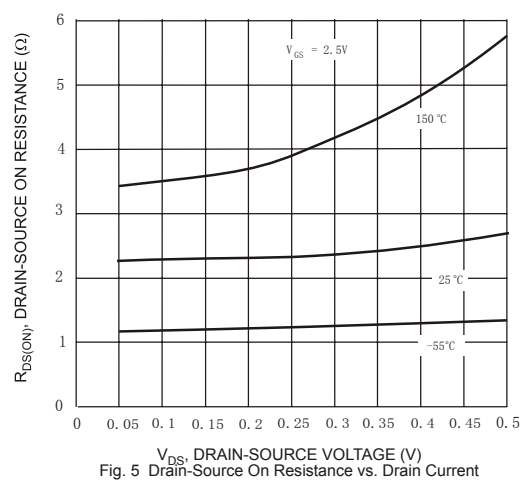
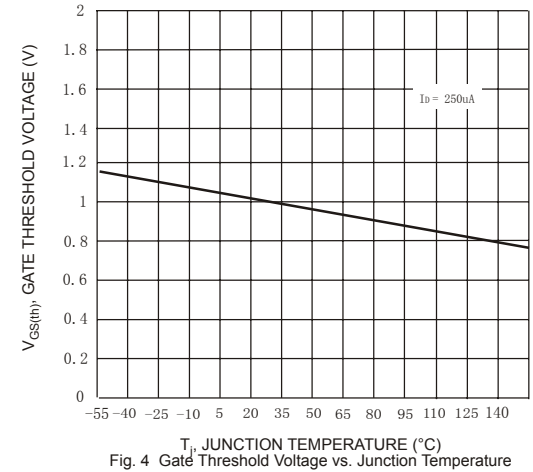
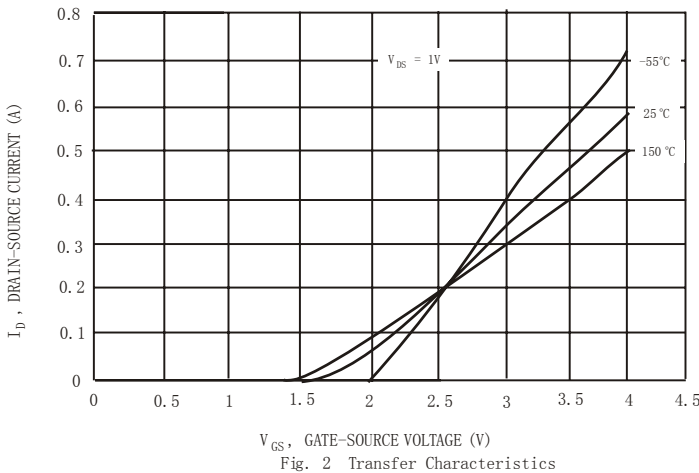
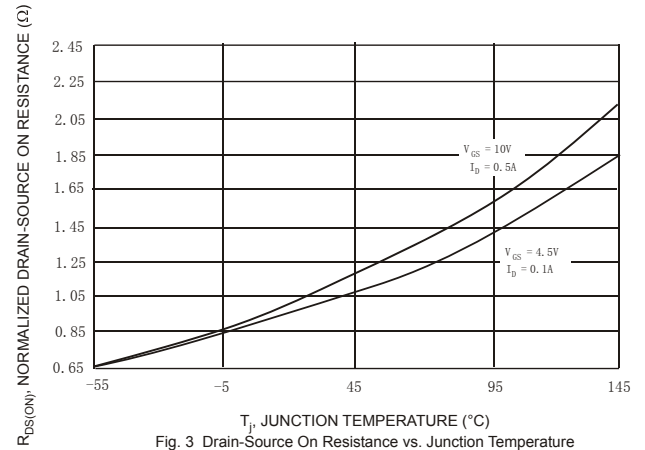
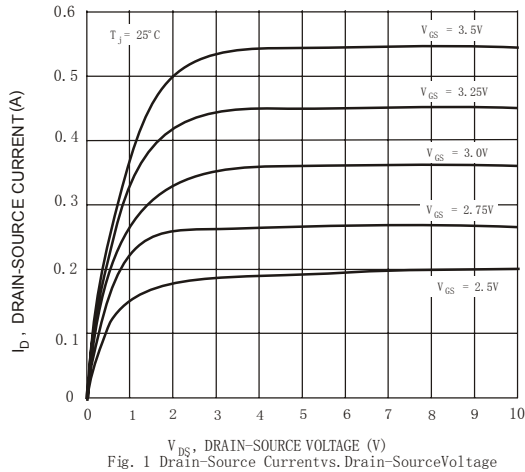

■ Typical Characteristics

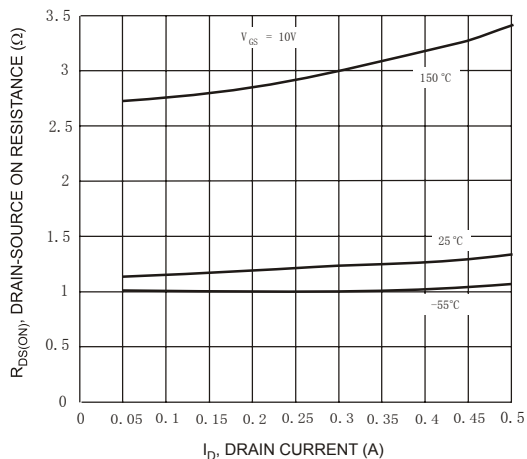

Fig. 7 Drain-Source On Resistance vs. Drain Current

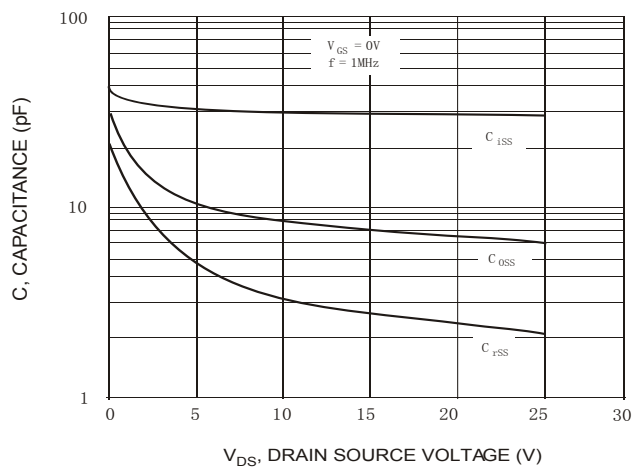

Fig. 8 Capacitance vs. Drain Source Voltage

单击下面可查看定价，库存，交付和生命周期等信息

[>>UMW\(友台半导体\)](#)