

■ Features

- $V_{DS} (V) = -20V$
- $R_{DS(ON)} < 40m\Omega (V_{GS} = -4.5V), I_D = -4.2A$
- $R_{DS(ON)} < 50m\Omega (V_{GS} = -2.5V), I_D = -3.4A$

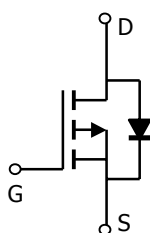
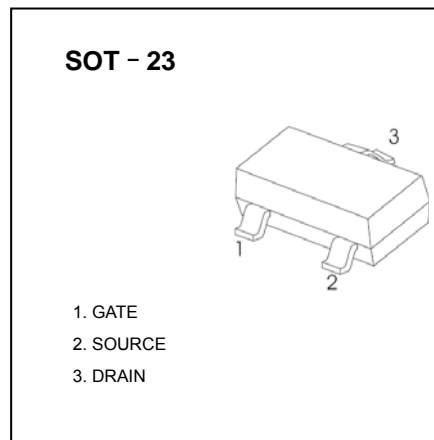

■ Absolute Maximum Ratings  $T_a = 25^\circ C$

Parameter	Symbol	Rating	Unit
Drain-source voltage	$V_{DS}$	-20	V
Gate-source voltage	$V_{GS}$	$\pm 12$	V
Continuous drain current	$I_D$	$T_A = 25^\circ C$ -4.2 $T_A = 70^\circ C$ -3.4	A
Pulsed drain current	$I_{DM}$	-10	A
Power dissipation	$P_D$	$T_A = 25^\circ C$ 1.38 $T_A = 70^\circ C$ 0.8	W
Thermal Resistance.Junction-to-Ambient	$R_{\theta JA}$	90	$^\circ C/W$
Operating junction and storage temperature range	$T_j, T_{stg}$	-55 to +150	$^\circ C$

■ Electrical Characteristics Ta = 25°C

Parameter	Symbol	Testconditions	Min	Typ	Max	Unit
Drain-source breakdown voltage	V <sub>DSS</sub>	V <sub>GS</sub> = 0 V, I <sub>D</sub> = -10 μA	-20			V
Gate threshold voltage	V <sub>GS(th)</sub>	V <sub>DS</sub> = V <sub>GS</sub> , I <sub>D</sub> = -250 μA	-0.5			V
Zero gate voltage drain current	I <sub>DSS</sub>	V <sub>DS</sub> = -20 V, V <sub>GS</sub> = 0 V			-1	μA
		V <sub>DS</sub> = -16 V, V <sub>GS</sub> = 0 V, T <sub>J</sub> = 55 °C			-10	
Gate-body leakage	I <sub>GSS</sub>	V <sub>DS</sub> = 0 V, V <sub>GS</sub> = ±12 V			±100	nA
Drain-source on-state resistance	r <sub>DS(on)</sub>	V <sub>GS</sub> = -4.5 V, I <sub>D</sub> = -4.2 A			40	mΩ
		V <sub>GS</sub> = -2.5 V, I <sub>D</sub> = -3.4A			50	
On-state drain current	I <sub>D(on)</sub>	V <sub>DS</sub> ≤ -5 V, V <sub>GS</sub> = -4.5 V	-6			A
		V <sub>DS</sub> ≤ -5 V, V <sub>GS</sub> = -2.5 V	-3			
Forward transconductance	g <sub>fs</sub>	V <sub>DS</sub> = -5 V, I <sub>D</sub> = -2.8 A		9		S
Input capacitance *	C <sub>iss</sub>	V <sub>DS</sub> = -15V, V <sub>GS</sub> = 0, f = 1 MHz		740		pF
Output capacitance *	C <sub>oss</sub>			167		
Reverse transfer capacitance *	C <sub>rss</sub>			126		
Total gate charge *	Q <sub>g</sub>	V <sub>DS</sub> = -16V, V <sub>GS</sub> = -4.5 V, I <sub>D</sub> = -4.2 A		10.6		nC
Gate-source charge *	Q <sub>gs</sub>			2.32		
Gate-drain charge *	Q <sub>gd</sub>			3.68		
Turn-on Delay time	t <sub>d(on)</sub>	V <sub>DD</sub> = -15V, R <sub>L</sub> = 3.6Ω, I <sub>D</sub> = -4.2A, V <sub>GEN</sub> = -10V, R <sub>G</sub> = 6Ω		5.9		ns
Turn-on Rise time	t <sub>r</sub>			3.6		
Turn-off Dealy time	t <sub>d(off)</sub>			32.4		
Turn-off Fall time	t <sub>f</sub>			2.6		
Continuous source current (diode conduction) *	I <sub>S</sub>			-1.6		A
Diode forward voltage	V <sub>SD</sub>	I <sub>S</sub> = -1.2 A, V <sub>GS</sub> = 0 V			-1.2	V

\* Pulse test: PW ≤ 300 μs duty cycle ≤ 2%.

■ Typical Characteristics

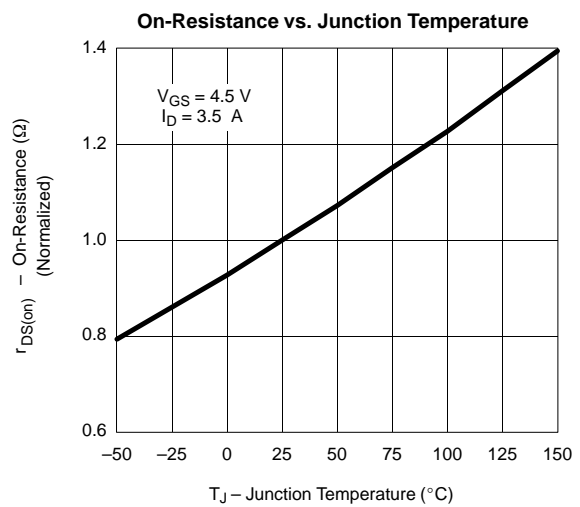
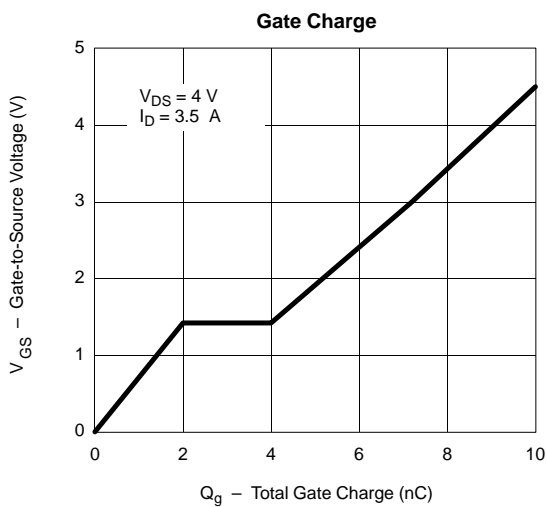
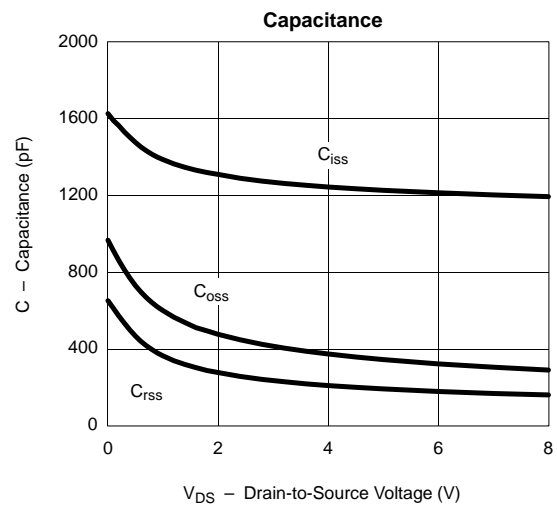
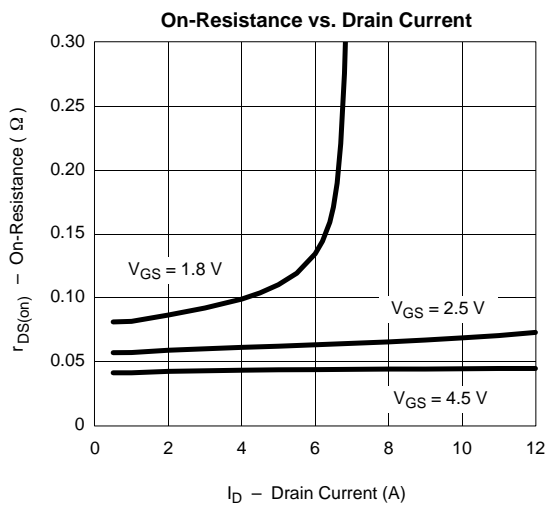
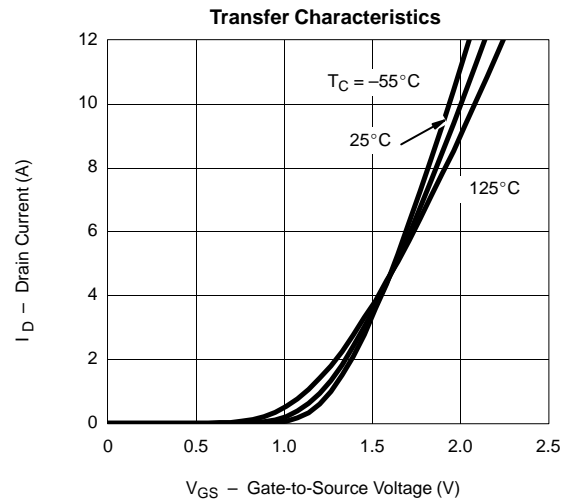
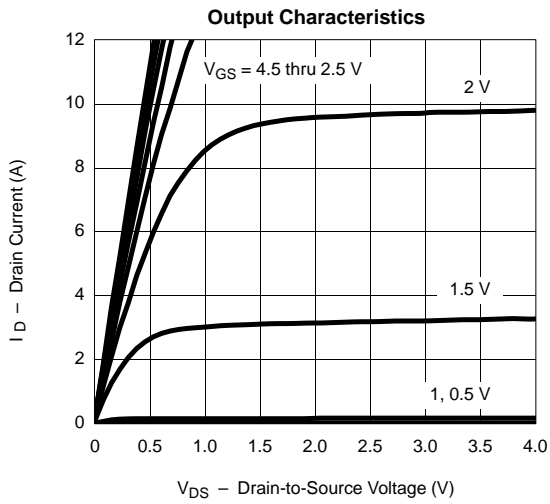

■ Typical Characteristics

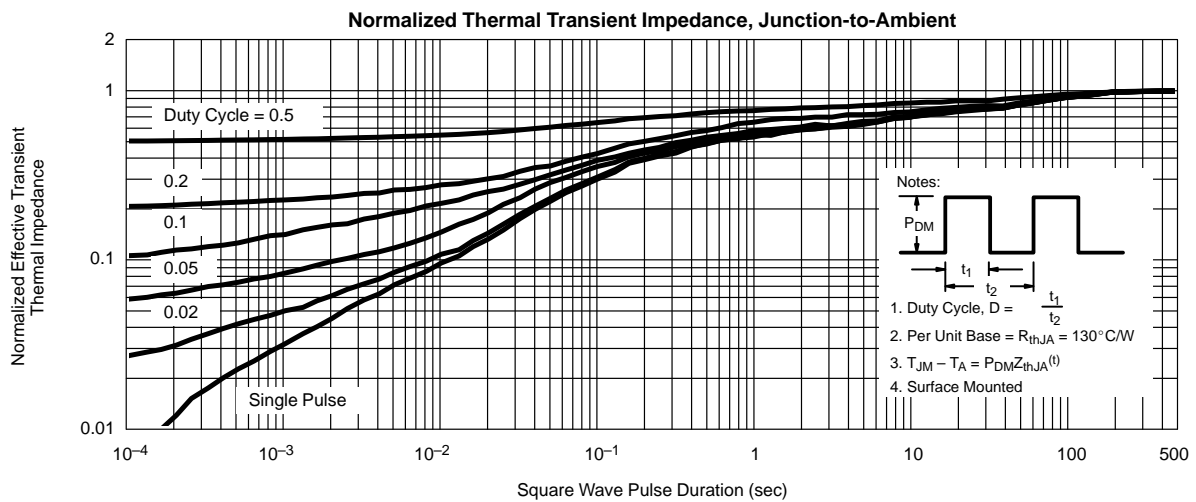
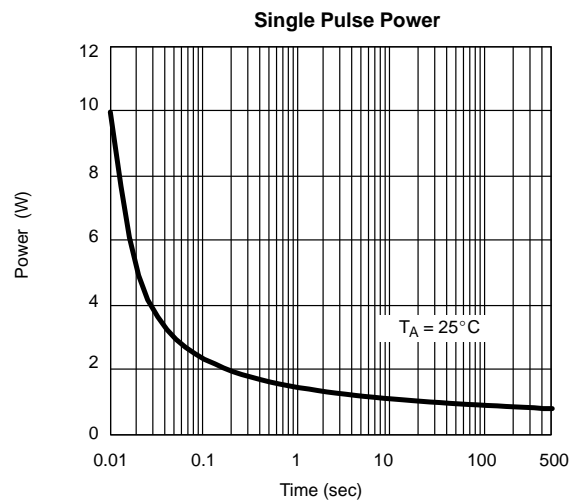
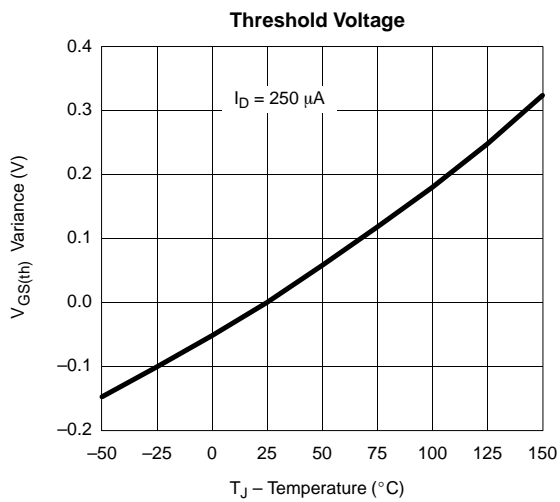
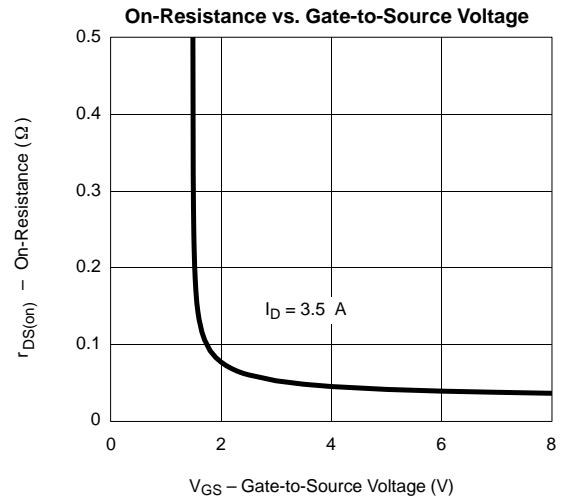
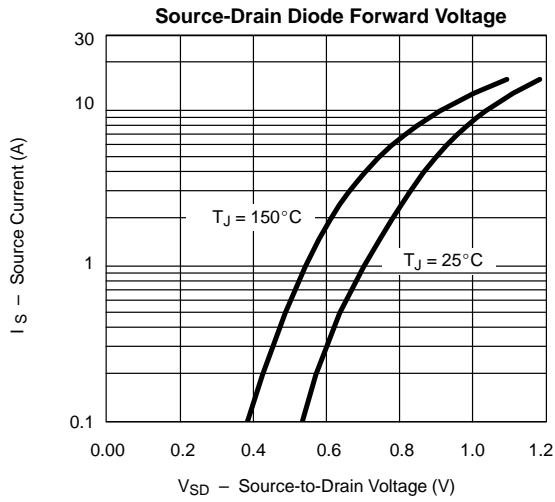

SOT-23 PACKAGE OUTLINE DIMENSIONS

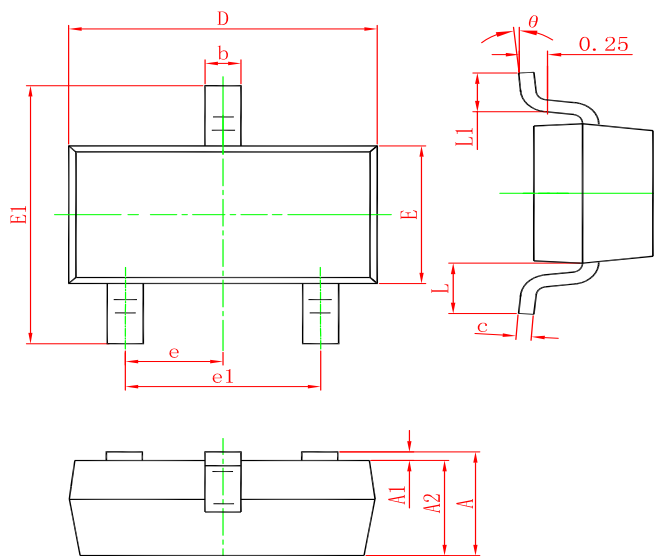

Symbol	Dimensions In Millimeters		Dimensions In Inches	
	Min.	Max.	Min.	Max.
A	0.900	1.150	0.035	0.045
A1	0.000	0.100	0.000	0.004
A2	0.900	1.050	0.035	0.041
b	0.300	0.500	0.012	0.020
c	0.080	0.150	0.003	0.006
D	2.800	3.000	0.110	0.118
E	1.200	1.400	0.047	0.055
E1	2.250	2.550	0.089	0.100
e	0.950 TYP.		0.037 TYP.	
e1	1.800	2.000	0.071	0.079
L	0.550 REF.		0.022 REF.	
L1	0.300	0.500	0.012	0.020
θ	0°	8°	0°	8°

Marking

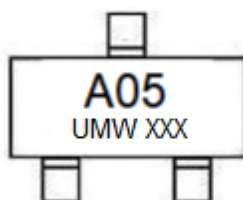

Ordering information

Order code	Package	Baseqty	Deliverymode
UMW SI2317A	SOT-23	3000	Tape and reel

单击下面可查看定价，库存，交付和生命周期等信息

[>>UMW\(友台半导体\)](#)