

Description

Features of this design are a 150°C junction operating temperature, fast switching speed and improved repetitive avalanche rating. These features combine to make this design an extremely efficient and reliable device for use in a wide variety of other applications.

Features

- $V_{DS} (V) = -60V$
- $I_D = -42A (V_{GS} = -10V)$
- $R_{DS(ON)} < 20m\Omega (V_{GS} = -10V)$
- Ultra Low On-Resistance
- 150°C Operating Temperature
- Fast Switching

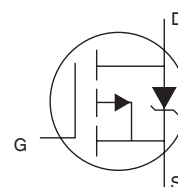
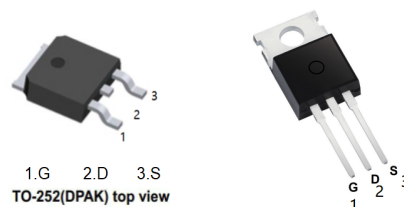

Absolute Maximum Ratings

| | Parameter | Max. | Units |
|------------------------------|--|--------------------------|-------|
| $I_D @ T_C = 25^\circ C$ | Continuous Drain Current, $V_{GS} @ 10V$ (Silicon Limited) | -70 | A |
| $I_D @ T_C = 100^\circ C$ | Continuous Drain Current, $V_{GS} @ 10V$ (Silicon Limited) | -44 | |
| $I_D @ T_C = 25^\circ C$ | Continuous Drain Current, $V_{GS} @ 10V$ (Package Limited) | -42 | |
| I_{DM} | Pulsed Drain Current ¹ | -280 | |
| $P_D @ T_C = 25^\circ C$ | Power Dissipation | 170 | W |
| | Linear Derating Factor | 1.3 | W/°C |
| V_{GS} | Gate-to-Source Voltage | ± 20 | V |
| E_{AS} (Thermally limited) | Single Pulse Avalanche Energy ² | 140 | mJ |
| E_{AS} (Tested) | Single Pulse Avalanche Energy Tested Value ⁶ | 790 | |
| I_{AR} | Avalanche Current ¹ | See Fig.12a, 12b, 15, 16 | A |
| E_{AR} | Repetitive Avalanche Energy ⁵ | | mJ |
| T_J | Operating Junction and | -55 to + 150 | °C |
| T_{STG} | Storage Temperature Range | | |
| | Soldering Temperature, for 10 seconds | 300 (1.6mm from case) | |
| | Mounting Torque, 6-32 or M3 screw ⁷ | 10 lbf•in (1.1N•m) | |

Thermal Resistance

| | Parameter | Typ. | Max. | Units |
|-----------------|---|------|------|-------|
| $R_{\theta JC}$ | Junction-to-Case ⁸ | | 0.75 | |
| $R_{\theta JA}$ | Junction-to-Ambient (PCB Mount, steady state) ^{7, 8} | | 40 | |

Electrical Characteristics @ $T_J = 25^\circ\text{C}$ (unless otherwise specified)

| | Parameter | Min. | Typ. | Max. | Units | Conditions |
|---------------------------------|--------------------------------------|------|--------|------|---------------------|---|
| $V_{(BR)DSS}$ | Drain-to-Source Breakdown Voltage | -55 | | | V | $V_{GS} = 0V, I_D = -250\mu A$ |
| $\Delta V_{(BR)DSS}/\Delta T_J$ | Breakdown Voltage Temp. Coefficient | | -0.054 | | V/ $^\circ\text{C}$ | Reference to $25^\circ\text{C}, I_D = -1\text{mA}$ |
| $R_{DS(on)}$ | Static Drain-to-Source On-Resistance | | | 20 | m Ω | $V_{GS} = -10V, I_D = -42A^3$ |
| $V_{GS(th)}$ | Gate Threshold Voltage | -1.1 | -1.8 | -2.5 | V | $V_{DS} = V_{GS}, I_D = -250\mu A$ |
| g_{fs} | Forward Transconductance | | 19 | | S | $V_{DS} = -25V, I_D = -42A$ |
| I_{DSS} | Drain-to-Source Leakage Current | | | -25 | μA | $V_{DS} = -55V, V_{GS} = 0V$ |
| | | | | -200 | | $V_{DS} = -44V, V_{GS} = 0V, T_J = 125^\circ\text{C}$ |
| I_{GSS} | Gate-to-Source Forward Leakage | | | 100 | nA | $V_{GS} = -20V$ |
| | Gate-to-Source Reverse Leakage | | | -100 | | $V_{GS} = 20V$ |
| Q_g | Total Gate Charge | | 120 | 180 | nC | $I_D = -42A$ $V_{DS} = -44V$ $V_{GS} = -10V^3$ |
| Q_{gs} | Gate-to-Source Charge | | 32 | | | |
| Q_{gd} | Gate-to-Drain ("Miller") Charge | | 53 | | | |
| $t_{d(on)}$ | Turn-On Delay Time | | 20 | | ns | $V_{DD} = -28V$ $I_D = -42A$ $R_G = 2.6\ \Omega$ $V_{GS} = -10V^3$ |
| t_r | Rise Time | | 99 | | | |
| $t_{d(off)}$ | Turn-Off Delay Time | | 51 | | | |
| t_f | Fall Time | | 64 | | | |
| L_S | Internal Source Inductance | | 7.5 | | nH | Between lead, and center of die contact |
| C_{iss} | Input Capacitance | | 3500 | | pF | $V_{GS} = 0V$ $V_{DS} = -25V$ $f = 1.0\text{MHz}$ $V_{GS} = 0V, V_{DS} = -1.0V, f = 1.0\text{MHz}$ $V_{GS} = 0V, V_{DS} = -44V, f = 1.0\text{MHz}$ $V_{GS} = 0V, V_{DS} = 0V \text{ to } -44V^4$ |
| C_{oss} | Output Capacitance | | 1250 | | | |
| C_{rss} | Reverse Transfer Capacitance | | 450 | | | |
| C_{oss} | Output Capacitance | | 4620 | | | |
| C_{oss} | Output Capacitance | | 940 | | | |
| $C_{oss \text{ eff.}}$ | Effective Output Capacitance | | 1530 | | | |

Source-Drain Ratings and Characteristics

| | Parameter | Min. | Typ. | Max. | Units | Conditions |
|----------|--|--|------|------|-------|---|
| I_S | Continuous Source Current (Body Diode) | | -42 | | A | MOSFET symbol showing the integral reverse p-n junction diode. |
| I_{SM} | Pulsed Source Current (Body Diode) ¹ | | | -280 | | |
| V_{SD} | Diode Forward Voltage | | | -1.3 | V | $T_J = 25^\circ\text{C}, I_S = -42A, V_{GS} = 0V^3$ |
| t_{rr} | Reverse Recovery Time | | 61 | 92 | ns | $T_J = 25^\circ\text{C}, I_F = -42A, V_{DD} = -28V$ |
| Q_{rr} | Reverse Recovery Charge | | 150 | 220 | nC | $di/dt = -100A/\mu s^3$ |
| t_{on} | Forward Turn-On Time | Intrinsic turn-on time is negligible (turn-on is dominated by LS+LD) | | | | |

Notes:

1. Repetitive rating; pulse width limited by max. junction temperature.
2. Limited by T_{Jmax} , starting $T_J = 25^\circ\text{C}$, $L = 0.16\text{mH}$
 $R_G = 25\ \Omega, I_{AS} = -42A, V_{GS} = -10V$. Part not recommended for use above this value.
3. Pulse width $\leq 1.0\text{ms}$; duty cycle $\leq 2\%$.
4. $C_{oss \text{ eff.}}$ is a fixed capacitance that gives the same charging time as C_{oss} while V_{DS} is rising from 0 to 80% V_{DSS} .
5. Limited by T_{Jmax} , see Fig.12a, 12b, 15, 16 for typical repetitive avalanche performance.
6. This value determined from sample failure population. 100% tested to this value in production.
7. This is applied to D²Pak, when mounted on 1" square PCB (FR-4 or G-10 Material).
8. R_θ is measured at T_J approximately 90°C

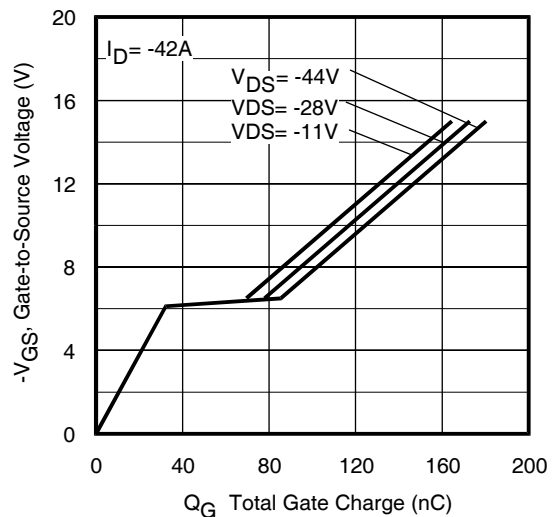
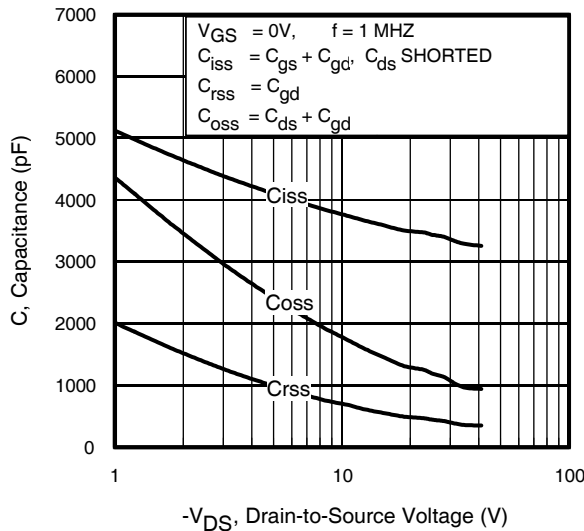
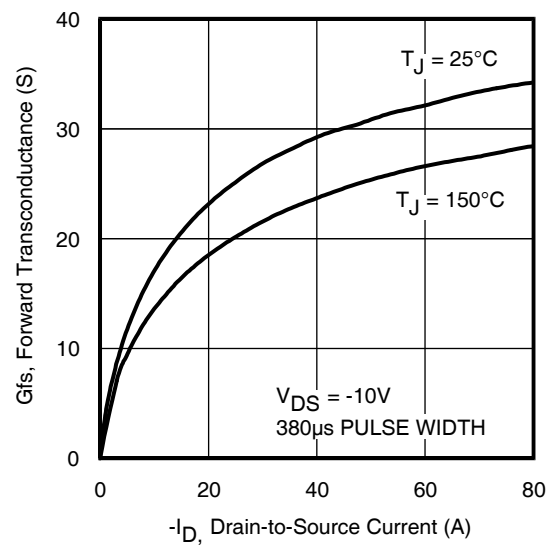
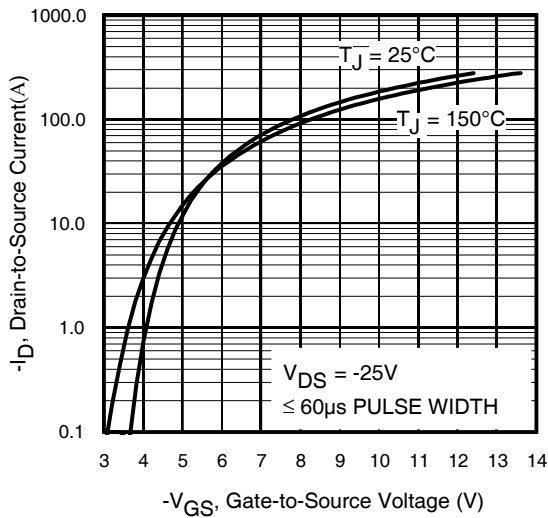
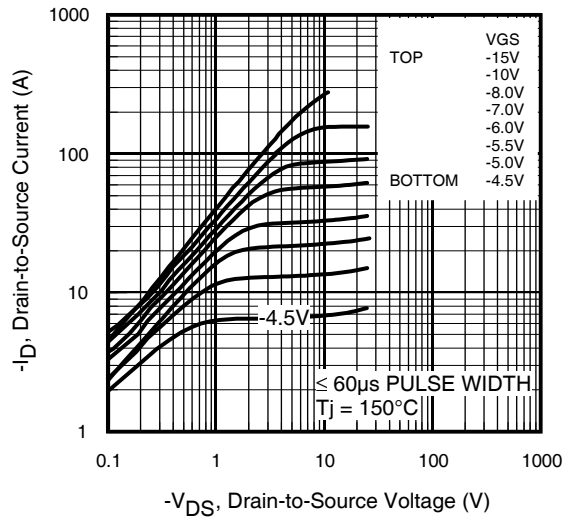
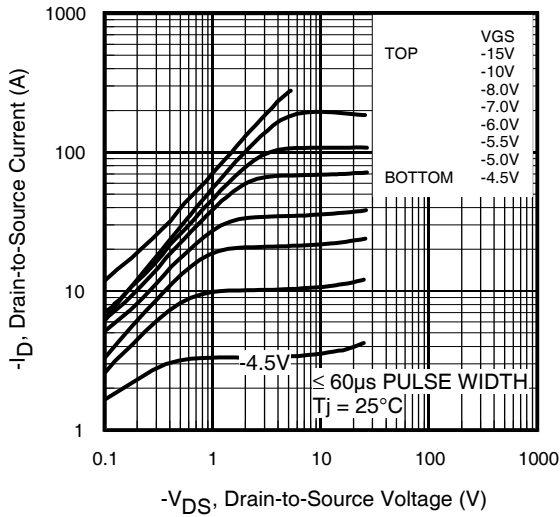

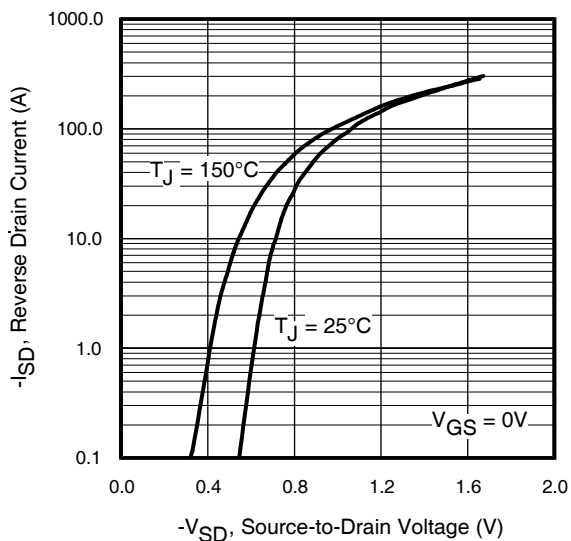

Fig 7. Typical Source-Drain Diode Forward Voltage

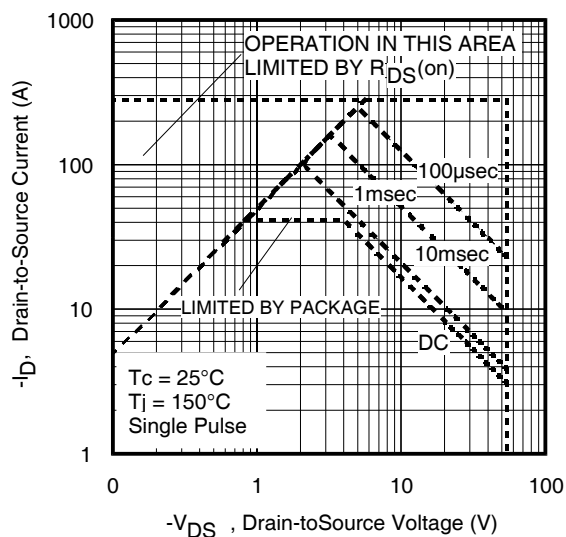

Fig 8. Maximum Safe Operating Area

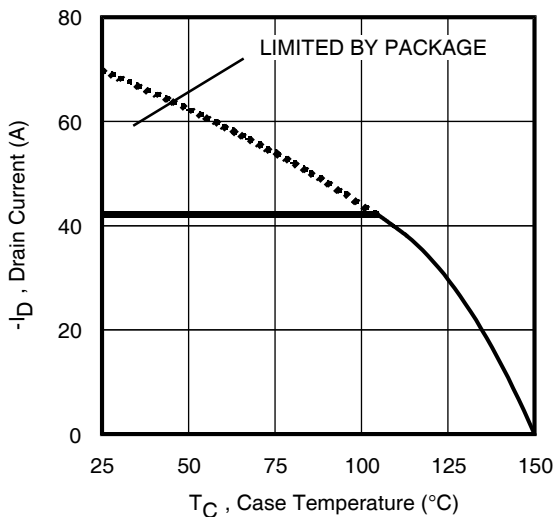

Fig 9. Maximum Drain Current Vs. Case Temperature

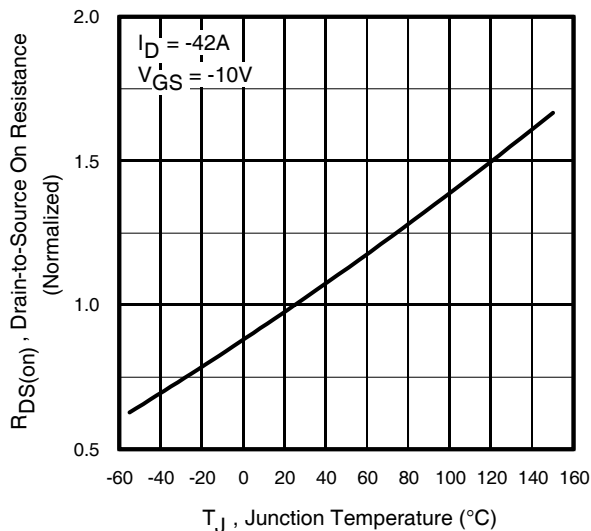

Fig 10. Normalized On-Resistance Vs. Temperature

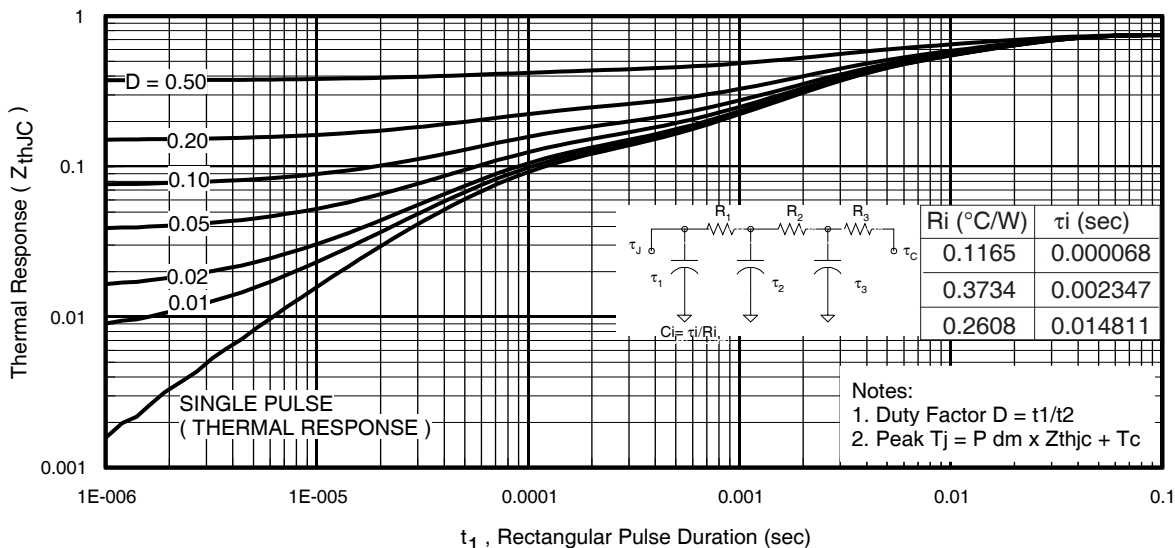

Fig 11. Maximum Effective Transient Thermal Immedance, Junction-to-Case

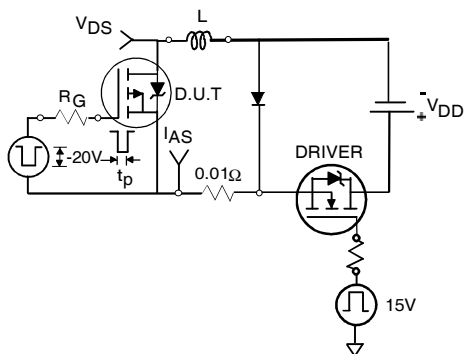

Fig 12a. Unclamped Inductive Test Circuit

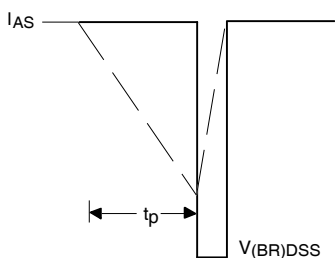

Fig 12b. Unclamped Inductive Waveforms

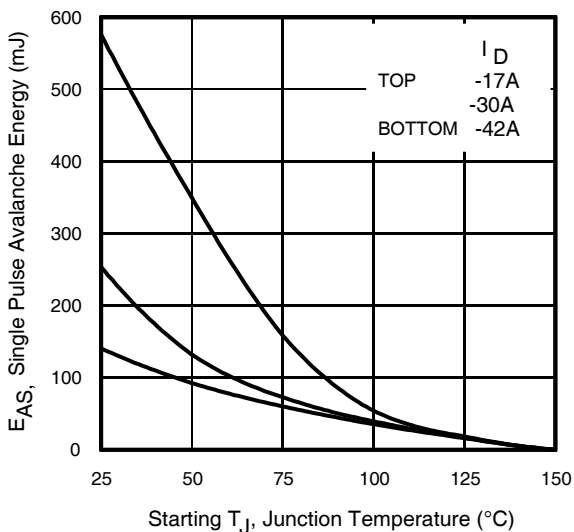

Fig 12c. Maximum Avalanche Energy Vs. Drain Current

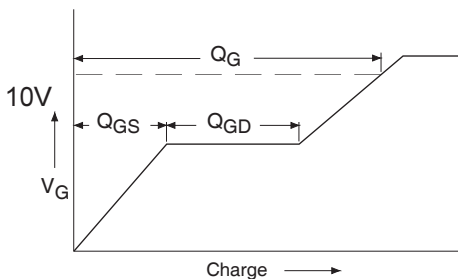

Fig 13a. Basic Gate Charge Waveform

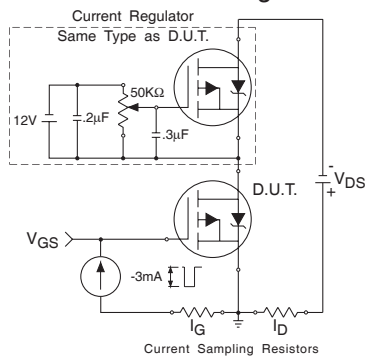

Fig 13b. Gate Charge Test Circuit

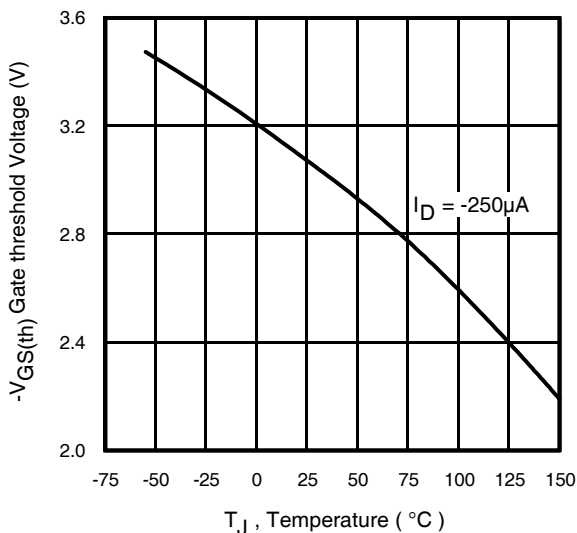

Fig 14. Threshold Voltage Vs. Temperature

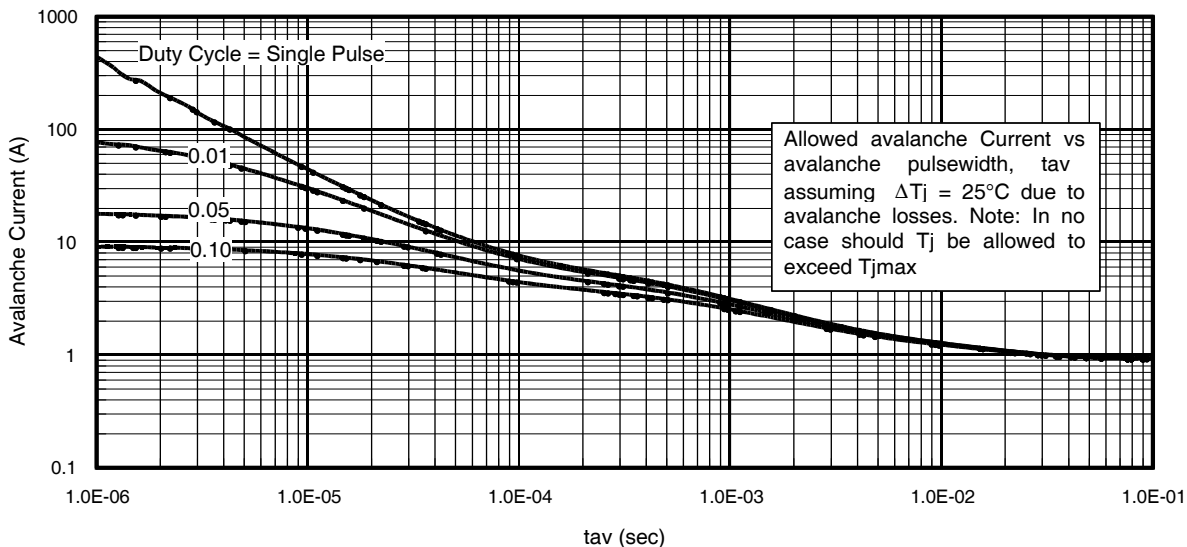

Fig 15. Typical Avalanche Current Vs.Pulsewidth

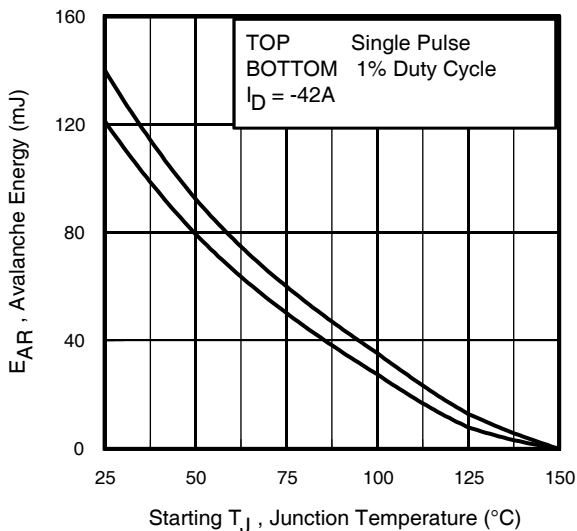

Fig 16. Maximum Avalanche Energy Vs. Temperature

Notes on Repetitive Avalanche Curves , Figures 15, 16:

1. Avalanche failures assumption: Purely a thermal phenomenon and failure occurs at a temperature far in excess of T_{jmax} . This is validated for every part type.
2. Safe operation in Avalanche is allowed as long as T_{jmax} is not exceeded.
3. Equation below based on circuit and waveforms shown in Figures 12a, 12b.
4. $P_{D(ave)}$ = Average power dissipation per single avalanche pulse.
5. BV = Rated breakdown voltage (1.3 factor accounts for voltage increase during avalanche).
6. I_{av} = Allowable avalanche current.
7. ΔT = Allowable rise in junction temperature, not to exceed T_{jmax} (assumed as 25°C in Figure 15, 16).
 t_{av} = Average time in avalanche.
 D = Duty cycle in avalanche = $t_{av} \cdot f$
 $Z_{thJC}(D, t_{av})$ = Transient thermal resistance)

$$P_{D(ave)} = 1/2 (1.3 \cdot BV \cdot I_{av}) = \Delta T / Z_{thJC}$$

$$I_{av} = 2\Delta T / [1.3 \cdot BV \cdot Z_{th}]$$

$$E_{AS(AR)} = P_{D(ave)} \cdot t_{av}$$

Package Mechanical Data TO-263

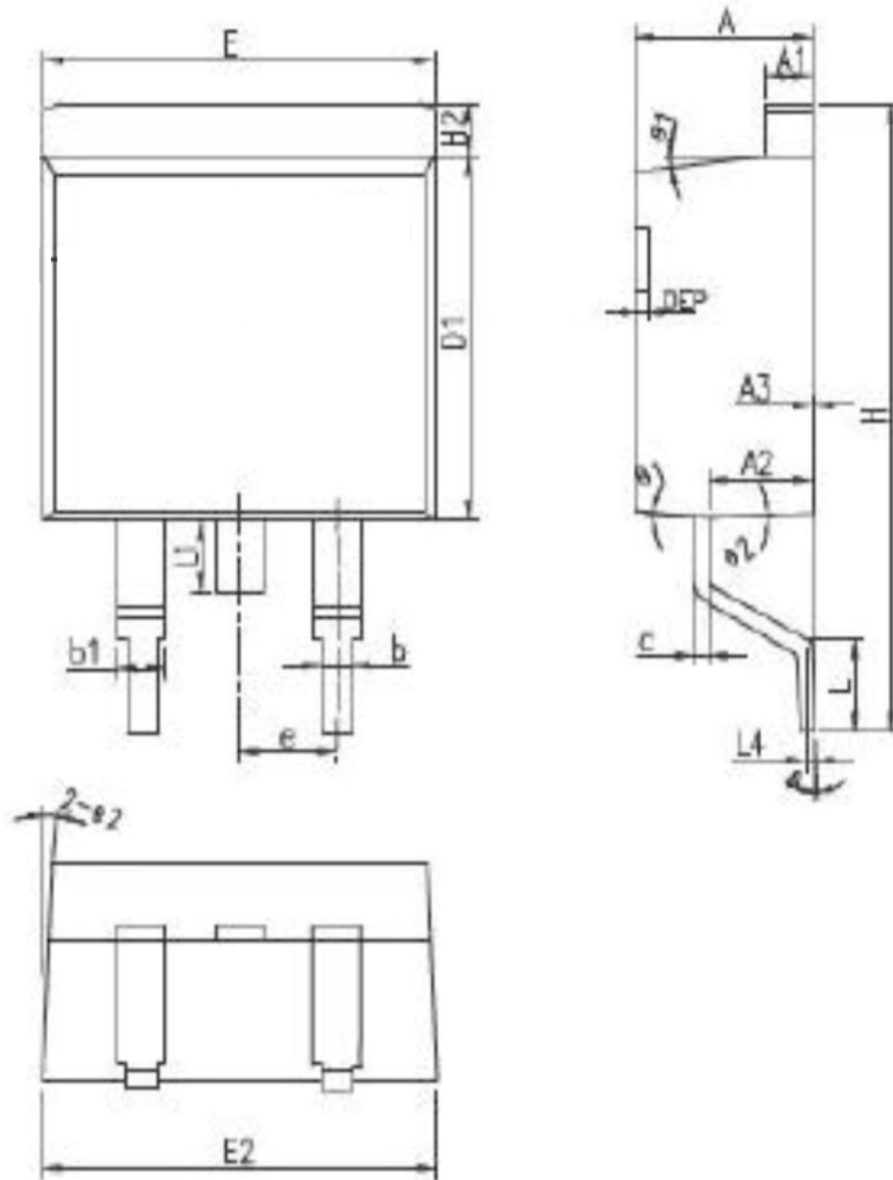

| Symbol | Inches | | | Millimeters | | |
|-----------|---------|-------|-------|-------------|-------|-------|
| | Min | Nom | Max | Min | Nom | Max |
| A | 4.40 | 4.57 | 4.57 | 0.173 | 0.180 | 0.185 |
| A1 | 1.22 | 1.27 | 1.27 | 0.048 | 0.050 | 0.052 |
| A2 | 2.59 | 2.69 | 2.69 | 0.102 | 0.106 | 0.110 |
| A3 | 0.00 | 0.10 | 0.10 | 0.000 | 0.004 | 0.008 |
| b | 0.77 | 0.813 | 0.813 | 0.030 | 0.032 | 0.035 |
| b1 | 1.20 | 1.270 | 1.270 | 0.047 | 0.050 | 0.054 |
| c | 0.34 | 0.381 | 0.381 | 0.013 | 0.015 | 0.019 |
| D1 | 8.60 | 8.70 | 8.99 | 0.339 | 0.343 | 0.354 |
| E | 10.00 | 10.16 | 10.16 | 0.394 | 0.400 | 0.404 |
| E2 | 10.00 | 10.10 | 10.10 | 0.394 | 0.398 | 0.402 |
| e | 2.54BSC | | | 0.100BSC | | |
| H | 14.70 | 15.10 | 15.50 | 0.579 | 0.594 | 0.610 |
| H2 | 1.17 | 1.27 | 1.40 | 0.046 | 0.050 | 0.055 |
| L | 2.00 | 2.30 | 2.60 | 0.079 | 0.091 | 0.102 |
| L1 | 1.45 | 1.55 | 1.70 | 0.057 | 0.061 | 0.067 |
| L4 | 0.25BSC | | | 0.010BSC | | |
| θ | 0° | 5° | 8° | 0° | 5° | 8° |
| $\theta1$ | 5° | 7° | 9° | 5° | 7° | 9° |
| $\theta2$ | 1° | 3° | 5° | 1° | 3° | 5° |
| DEP | 0.05 | 0.10 | 0.20 | 0.002 | 0.004 | 0.008 |

Package Mechanical Data TO-220

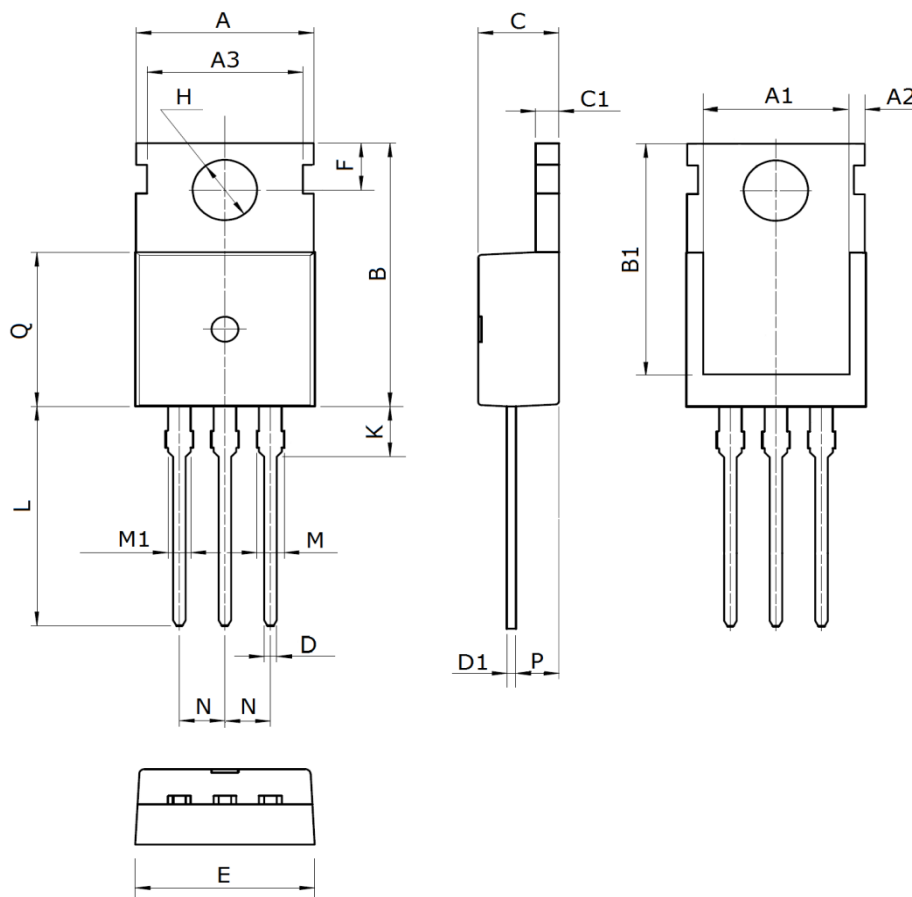

| Symbol | Dimensions (mm) | Symbol | Dimensions (mm) | Symbol | Dimensions (mm) |
|--------|-----------------|--------|-----------------|--------|------------------|
| A | 10.0±0.3 | C1 | 1.3±0.2 | L | 13.2±0.4 |
| A1 | 8.0±0.2 | D | 0.8±0.2 | M | 1.38±0.1 |
| A2 | 0.94±0.1 | D1 | 0.5±0.1 | M1 | 1.28±0.1 |
| A3 | 8.7±0.1 | E | 10.0±0.3 | N | 2.54(typ) |
| B | 15.6±0.4 | F | 2.8±0.1 | P | 2.4±0.3 |
| B1 | 13.2±0.2 | H | 3.6±0.1 | Q | 9.15±0.25 |
| C | 4.5±0.2 | K | 3.1±0.2 | | |

Package Mechanical Data TO-252

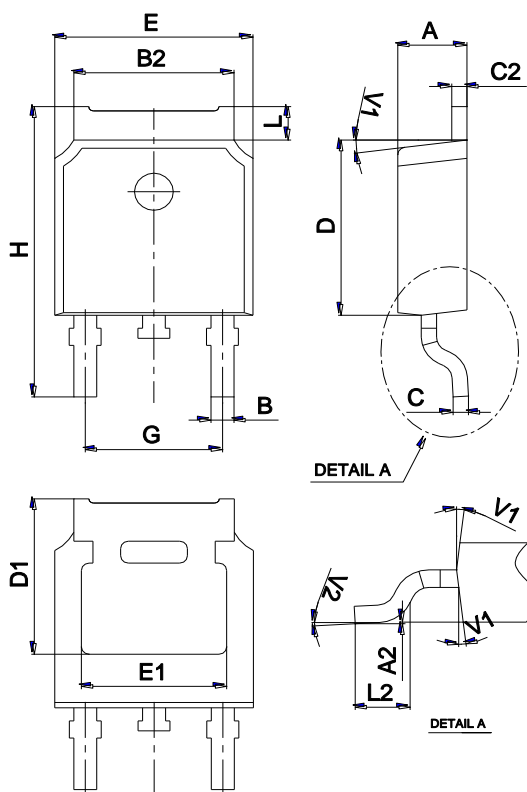

| Ref. | Dimensions | | | | | |
|------|-------------|------|-------|----------|------|-------|
| | Millimeters | | | Inches | | |
| | Min. | Typ. | Max. | Min. | Typ. | Max. |
| A | 2.10 | | 2.50 | 0.083 | | 0.098 |
| A2 | 0 | | 0.10 | 0 | | 0.004 |
| B | 0.66 | | 0.86 | 0.026 | | 0.034 |
| B2 | 5.18 | | 5.48 | 0.202 | | 0.216 |
| C | 0.40 | | 0.60 | 0.016 | | 0.024 |
| C2 | 0.44 | | 0.58 | 0.017 | | 0.023 |
| D | 5.90 | | 6.30 | 0.232 | | 0.248 |
| D1 | 5.30REF | | | 0.209REF | | |
| E | 6.40 | | 6.80 | 0.252 | | 0.268 |
| E1 | 4.63 | | | 0.182 | | |
| G | 4.47 | | 4.67 | 0.176 | | 0.184 |
| H | 9.50 | | 10.70 | 0.374 | | 0.421 |
| L | 1.09 | | 1.21 | 0.043 | | 0.048 |
| L2 | 1.35 | | 1.65 | 0.053 | | 0.065 |
| V1 | | 7° | | | 7° | |
| V2 | 0° | | 6° | 0° | | 6° |

Ordering information

| Order code | Package | Baseqty | Deliverymode |
|------------------|---------|---------|---------------|
| UMW IRF4905STRL | TO-252 | 2500 | Tape and reel |
| UMW IRF4905STRLP | TO-263 | 800 | Tape and reel |
| UMW IRF4905 | TO-220 | 1000 | Tube and Box |

单击下面可查看定价，库存，交付和生命周期等信息

[>>UMW\(友台半导体\)](#)