

SOT-23 Plastic-Encapsulate Transistors
MMBT2222A TRANSISTOR (NPN)

FEATURES

- Epitaxial planar die construction
- Complementary PNP Type available(MMBT2907A)

MAXIMUM RATINGS (T_a=25°C unless otherwise noted)

Symbol	Parameter	Value	Unit
V _{CB0}	Collector-Base Voltage	75	V
V _{CEO}	Collector-Emitter Voltage	40	V
V _{EBO}	Emitter-Base Voltage	6	V
I _C	Collector Current -Continuous	600	mA
P _C	Collector Dissipation	300	mW
R _{eJA}	Thermal Resistance, Junction to Ambient	417	°C/W
T _J	Junction Temperature	150	°C
T _{stg}	Storage Temperature	-55~+150	°C

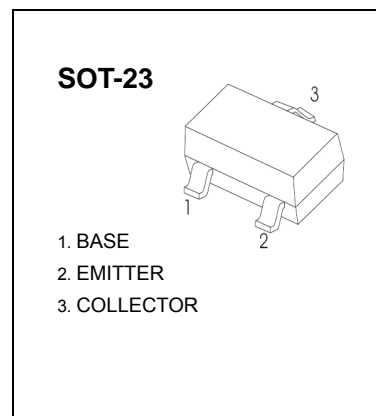
ELECTRICAL CHARACTERISTICS (T_a=25°C unless otherwise specified)

Parameter	Symbol	Test conditions	Min	Typ	Max	Unit
Collector-base breakdown voltage	V _{(BR)CBO}	I _C = 10μA, I _E =0	75			V
Collector-emitter breakdown voltage	V _{(BR)CEO} *	I _C = 10mA, I _B =0	40			V
Emitter-base breakdown voltage	V _{(BR)EBO}	I _E =10μA, I _C =0	6			V
Collector cut-off current	I _{CBO}	V _{CB} =60V, I _E =0			0.01	μA
Collector cut-off current	I _{CEX}	V _{CE} =30V, V _{BE(off)} =3V			0.01	μA
Emitter cut-off current	I _{EBO}	V _{EB} = 3V, I _C =0			0.1	μA
DC current gain	h _{FE(1)} *	V _{CE} =10V, I _C = 150mA	100		300	
	h _{FE(2)}	V _{CE} =10V, I _C = 0.1mA	40			
	h _{FE(3)} *	V _{CE} =10V, I _C = 500mA	42			
Collector-emitter saturation voltage	V _{CE(sat)} *	I _C =500 mA, I _B = 50mA I _C =150 mA, I _B =15mA			1 0.3	V
Base-emitter saturation voltage	V _{BE(sat)} *	I _C =500 mA, I _B = 50mA I _C =150 mA, I _B =15mA			2.0 1.2	V
Transition frequency	f _T	V _{CE} =20V, I _C = 20mA, f=100MHz	300			MHz
Delay time	t _d	V _{CC} =30V, V _{BE(off)} =-0.5V I _C =150mA, I _{B1} = 15mA			10	ns
Rise time	t _r				25	ns
Storage time	t _s	V _{CC} =30V, I _C =150mA			225	ns
Fall time	t _f	I _{B1} =-I _{B2} =15mA			60	ns

*pulse test: Pulse Width ≤300μs, Duty Cycle≤ 2.0%.

CLASSIFICATION OF h_{FE(1)}

RANK	L	H
RANGE	100 - 200	200 - 300
MARKING	1D	

SOT-23 Plastic-Encapsulate Transistors

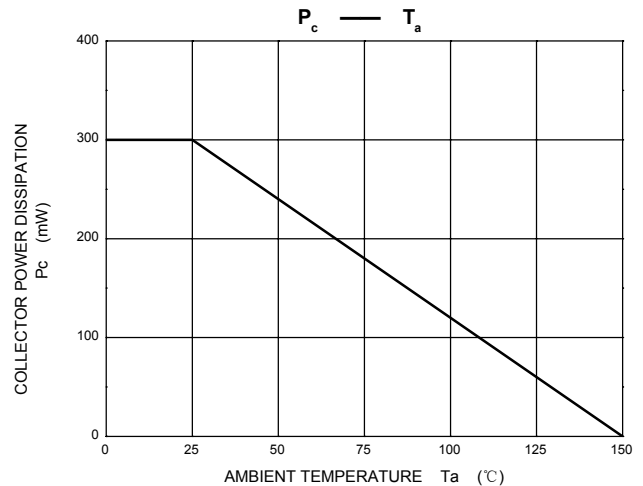
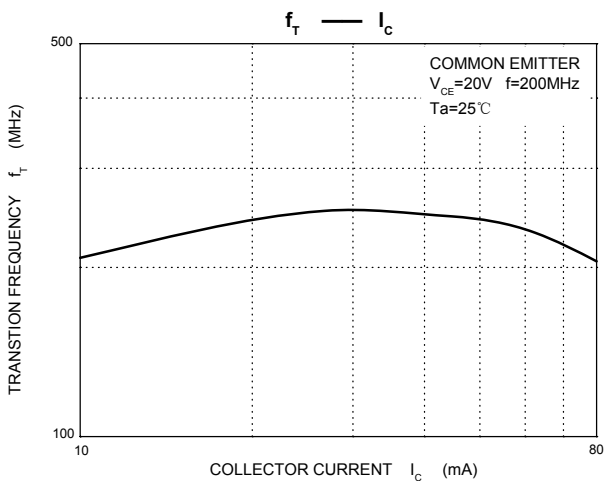
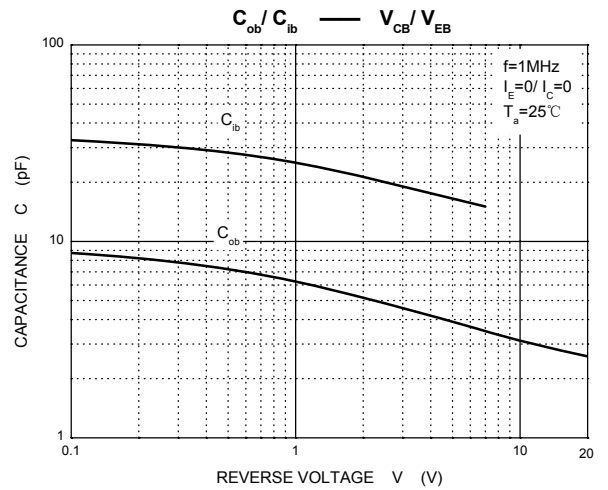
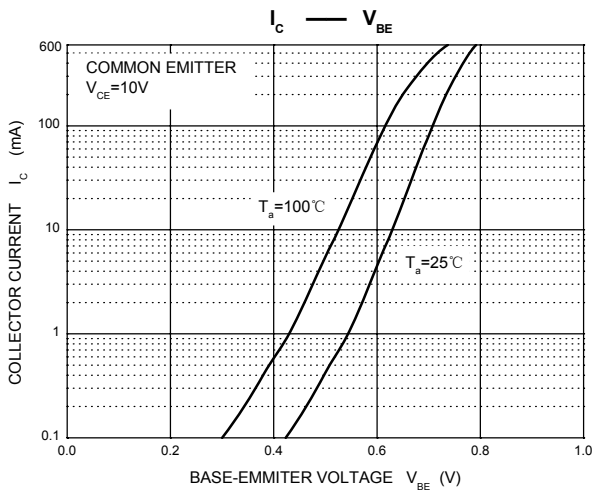
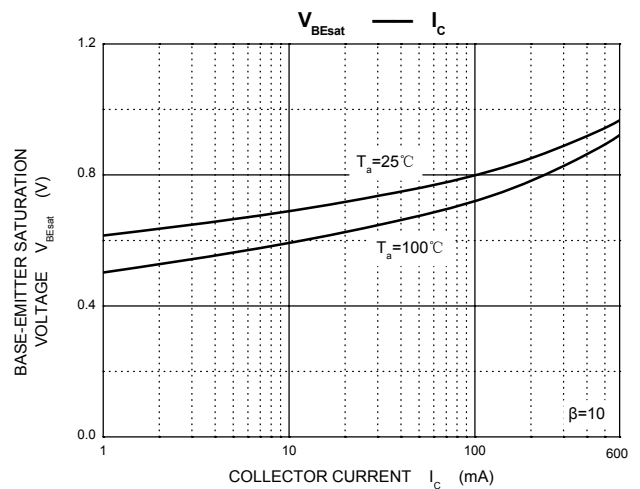
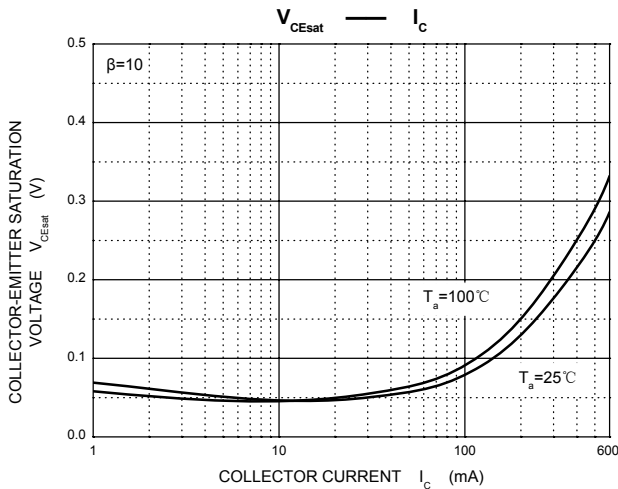
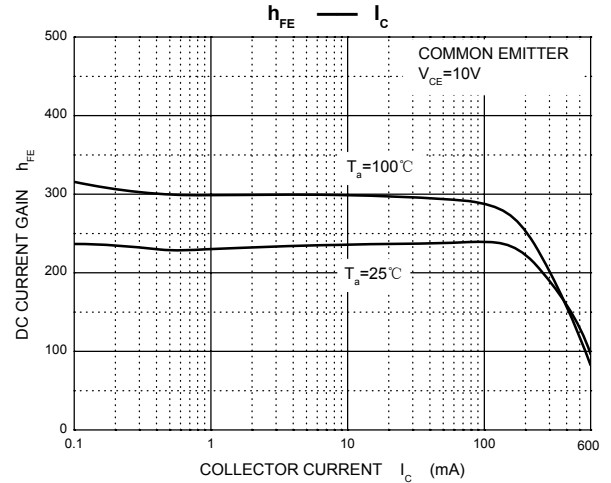
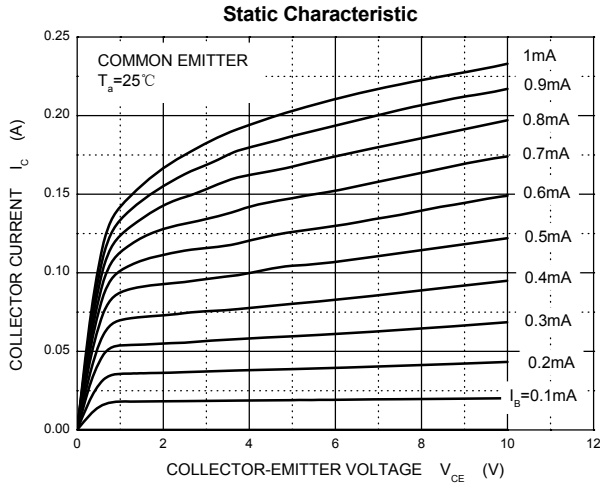

单击下面可查看定价，库存，交付和生命周期等信息

[>>UMW\(友台半导体\)](#)