

Features

- 350Watts peak pulse power (tp = 8/20µs)
- Unidirectional configurations
- Solid-state silicon-avalanche technology
- Low clamping voltage
- Low leakage current
- IEC 61000-4-2 ±30kV contact ±30kV air
- IEC 61000-4-4 (EFT) 40A(5/50ns)
- IEC 61000-4-5 (Lightning) 17A(8/20µs)

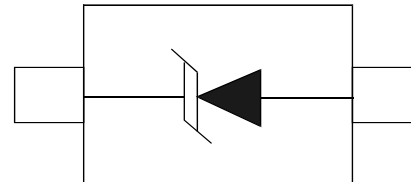

SOD-323

Mechanical Data

- SOD-323 package
- Molding compound flammability rating: UL94V-0
- Packaging: Tape and Reel

Applications

- USB Vbus,
- Power Line
- Power management

Absolute Maximum Rating

Rating	Symbol	Value	Units
Peak Pulse Power (tp =8/20µs)	P _{PP}	350	Watts
Peak Pulse Current (tp =8/20µs) (note1)	I _{pp}	17	A
ESD per IEC 61000-4-2 (Air) ESD per IEC 61000-4-2 (Contact)	V _{ESD}	30 30	kV
Lead Soldering Temperature	T _L	260(10seconds)	°C
Junction Temperature	T _J	-55 to + 150	°C
Storage Temperature	T _{stg}	-55 to + 150	°C

Electrical Characteristics

Parameter	Symbol	Conditions	Min	Typical	Max	Units
Reverse Stand-Off Voltage	V_{RWM}				5.0	V
Reverse Breakdown Voltage	V_{BR}	$I_T=1mA$	6.0			V
Reverse Leakage Current	I_R	$V_{RWM}=5V, T=25^{\circ}C$			1	μA
Clamping Voltage	V_C	$I_{PP}=17A, t_p=8/20\mu s$		17	19	V
Junction Capacitance	C_j	$V_R = 0V, f = 1MHz$		120	135	pF

Electrical Parameters (TA = 25°C unless otherwise noted)

Symbol	Parameter
I_{PP}	Maximum Reverse Peak Pulse Current
V_C	Clamping Voltage @ I_{PP}
V_{RWM}	Working Peak Reverse Voltage
I_R	Maximum Reverse Leakage Current @ V_{RWM}
V_{BR}	Breakdown Voltage @ I_T
I_T	Test Current

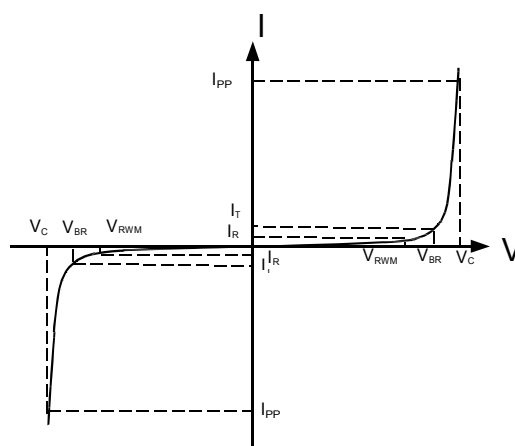

Typical Characteristics

Figure 1: Peak Pulse Power vs. Pulse Time

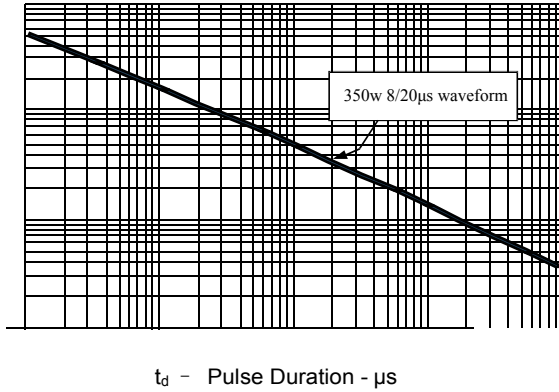

Figure 2: Power Derating Curve

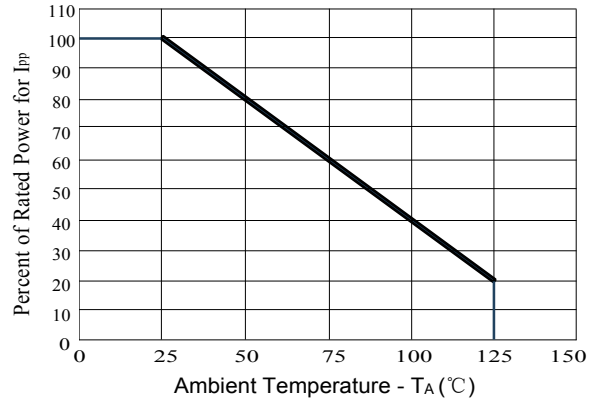

Figure 3: Pulse Waveform

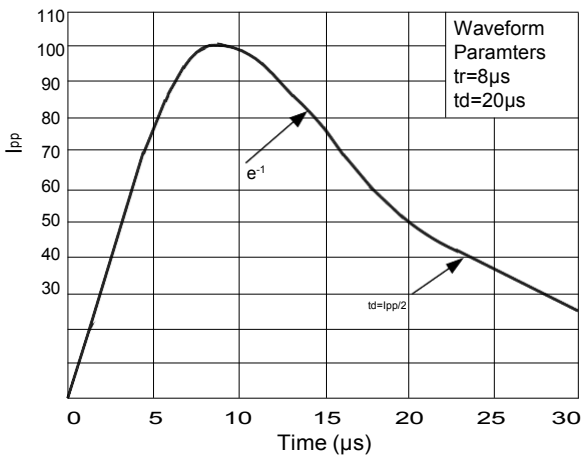
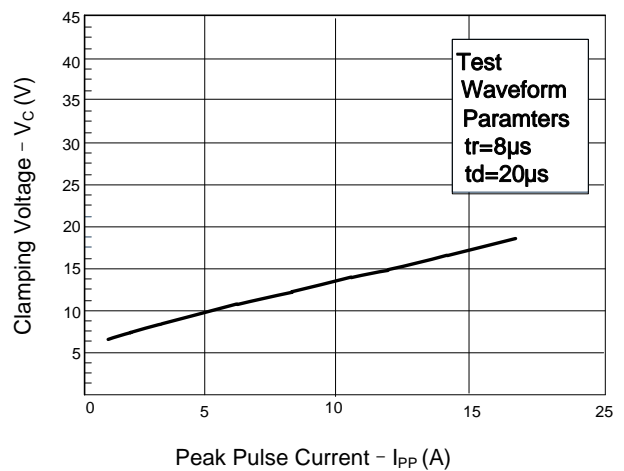
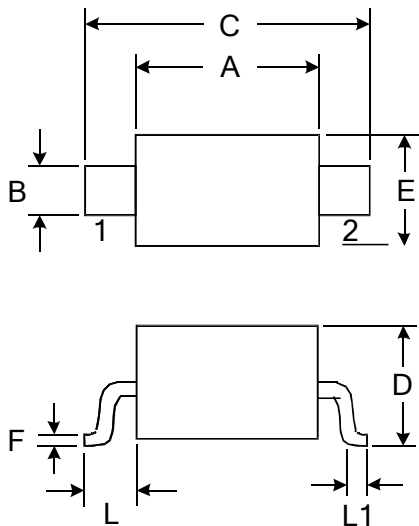

Figure 4: Clamping Voltage vs. Ipp



Outline Drawing – SOD-323



DIMENSIONS				
SYMBOL	MILLIMETER		INCHES	
	MIN	MAX	MIN	MAX
A	1.600	1.800	0.063	0.071
B	0.250	0.350	0.010	0.014
C	2.500	2.700	0.098	0.106
D		1.000		0.039
E	1.200	1.400	0.047	0.055
F	0.080	0.150	0.003	0.006
L	0.475 REF		0.019REF	
L1	0.250	0.400	0.010	0.016
H	0.000	0.100	0.000	0.004

Marking



Ordering information

Order code	Package	Baseqty	Deliverymode
UMW BSD3A051V	SOD-323	3000	Tape and reel

单击下面可查看定价，库存，交付和生命周期等信息

[>>UMW\(友台半导体\)](#)