

SOT-23 Plastic-Encapsulate Transistors

.....67, %± TRANSISTOR (NPN)

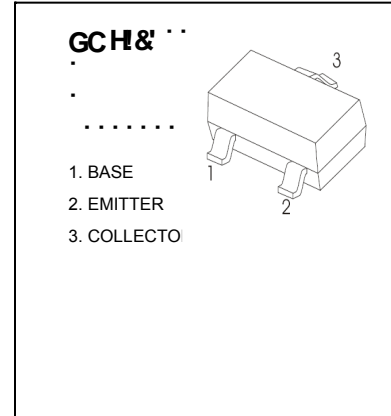

: 95HI F9G

- For general AF applications
- High collector current
- High current gain
- Low collector-emitter saturation voltage
- Complementary types: BC807 (PNP)

A5L-AI A F5HB; Gfh1&) °C i b`Ygg`cH Yfk JgY`bcHXL`

Gna Vc`	DUFUa YHf`	JUi Y`	I b]h
J76c`	Collector-Base Voltage	50	V
J79c`	Collector-Emitter Voltage	45	V
J96c`	Emitter-Base Voltage	5	V
7`	Collector Current -Continuous	0.5	A
D7`	Collector Power Dissipation	0.3	W
H^	Junction Temperature	150	°C
H _{gft} `	Storage Temperature	-55-150	°C

9 @7 HF 7 5 @7 <5 F57 H9F -GH7 G`fh1&) °C i b`Ygg`cH Yfk JgY`gdYWZ`YXL`

DUFUa YHf`	Gna Vc`	HYgh VtbX]hcbg`	Ain	Typ`	Aax	Unit
7c`YWcf!VUgY VfyU_Xck b`j`c`HJ` Y`	V _{CB0}	I _C = 10μA, I _E =0	50			V
7c`YWcf!Ya]Hf` VfyU_Xck b`j`c`HJ` Y`	V _{CE0}	I _C = 10mA, I _B =0	45			V
9a]Hf`!VUgY VfyU_Xck b`j`c`HJ` Y`	V _{EBO}	I _E = 1μA, I _C =0	5			V
7c`YWcf`W HcZZW ffYbh	I _{CB0}	V _{CB} = 45 V, I _E =0			0.1	μA
9a]Hf` W HcZZW ffYbh	I _{EBO}	V _{EB} = 4V, I _C =0			0.1	μA
87`W ffYbh[Ujb`	h _{FE(1)}	V _{CE} = 1V, I _C = 100mA	100		600	
	h _{FE(2)}	V _{CE} = 1V, I _C = 500mA	40			
7c`YWcf!Ya]Hf` gUhi fU]cb`j`c`HJ` Y`	V _{CE(sat)}	I _C = 500mA, I _B = 50mA			0.7	V
6 UgY!Ya]Hf` gUhi fU]cb`j`c`HJ` Y`	V _{BE(sat)}	I _C = 500mA, I _B = 50mA			1.2	V
6 UgY!Ya]Hf` j`c`HJ` Y`	V _{BE}	V _{CE} = 1 V, I _C = 500mA			1.2	V
7c`YWyf`WUdUW]UbW`	C _{ob}	V _{CB} =10V, f=1MHz		10		pF
HfUbg]hcb`Z`Yei YbWni	f _T	V _{CE} = 5 V, I _C = 10mA f=100MHz	100			MHz

7 @ GG 7 5 HCB`C: h_{FE`} %`

Fub`	67, %!%`	67, %!&`	67, %!(\$`
Fub[Y`	%%\$!&`\$`	%\$!(\$\$`	&)\$!* \$\$`
AUf_]b[`	*5`	*6`	*7`

SOT-23 Plastic-Encapsulate Transistors

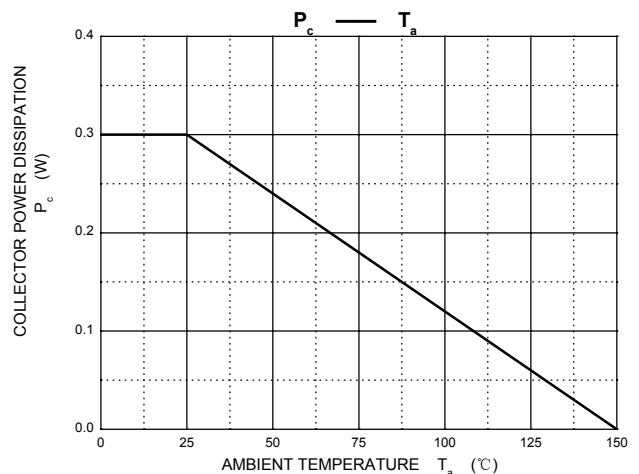
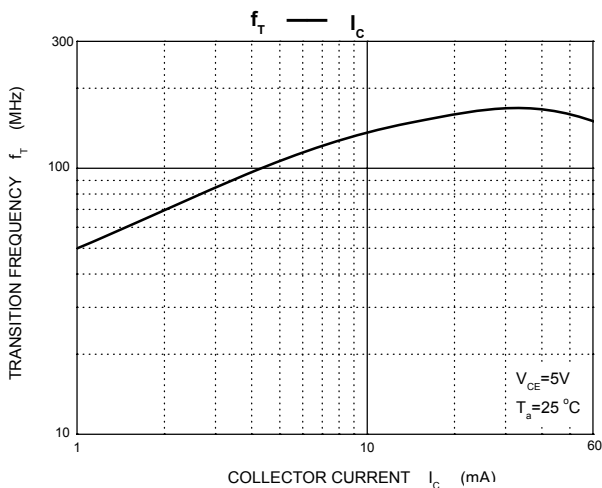
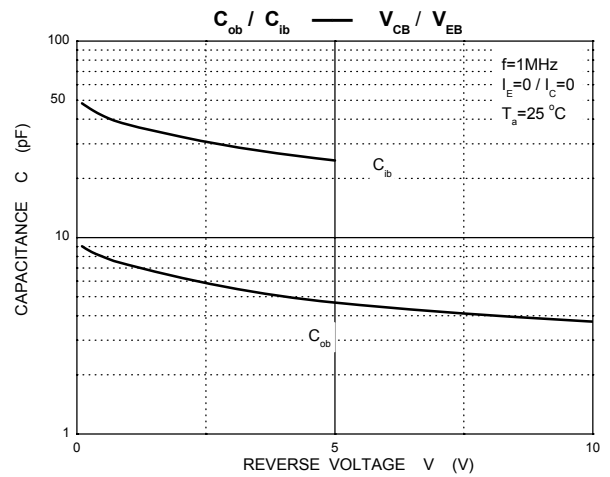
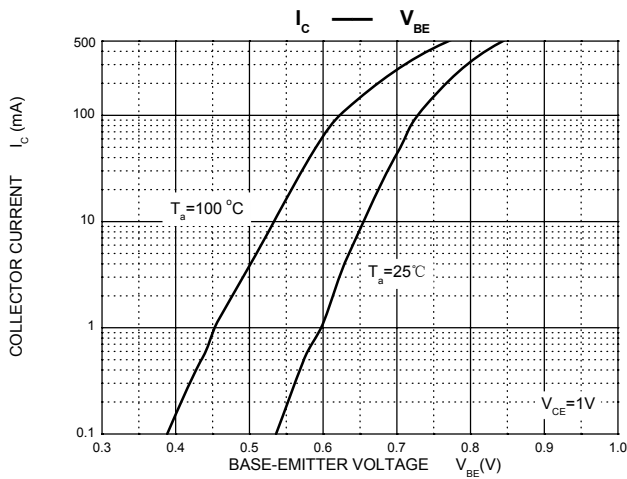
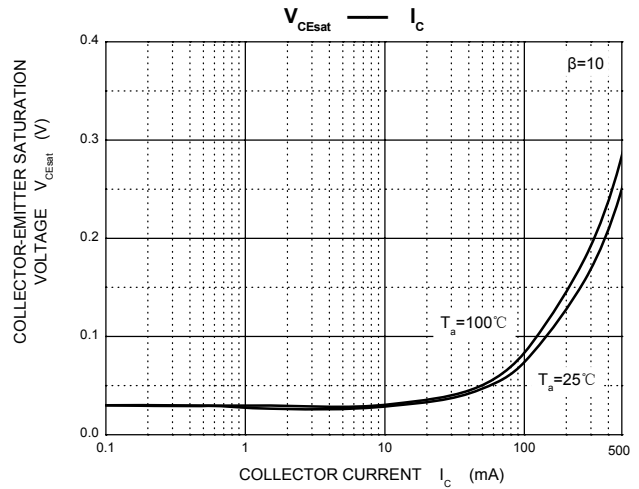
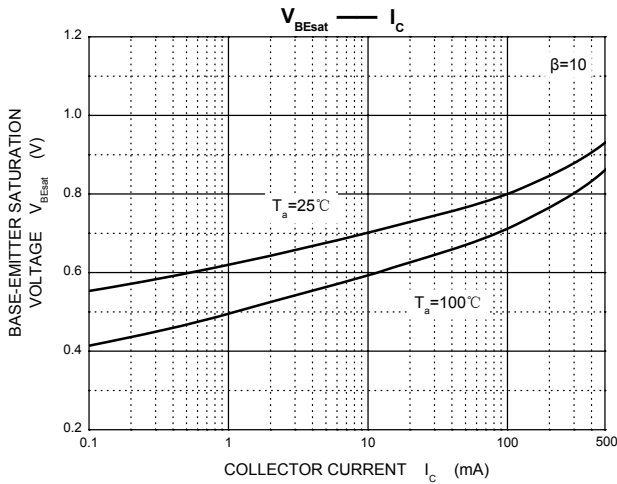
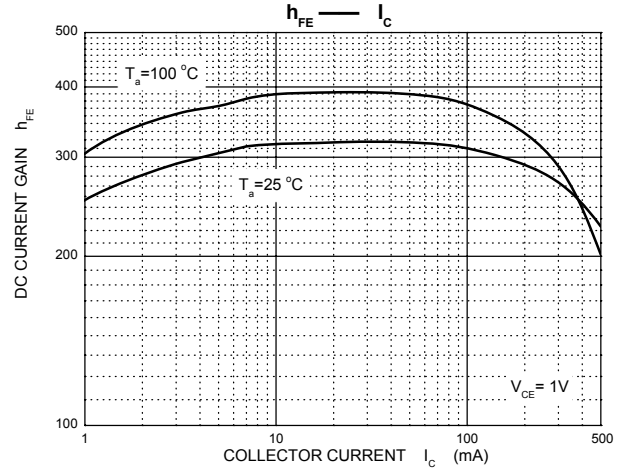
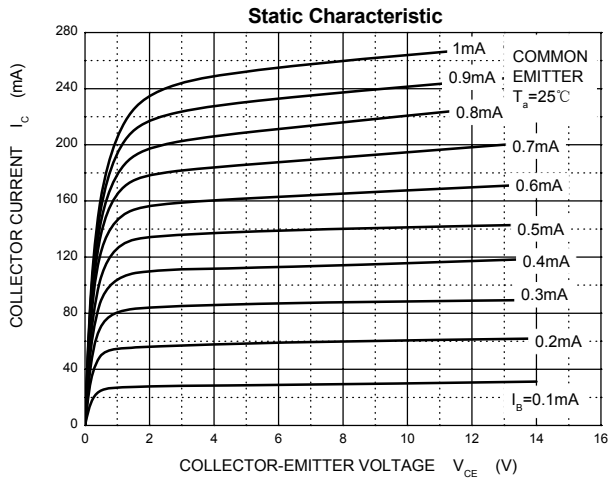

单击下面可查看定价，库存，交付和生命周期等信息

[>>UMW\(友台半导体\)](#)