

N-Channel Enhancement MOSFET

■ Features

- $V_{DS(V)} = 20V$
- $I_D = 4.2A (V_{GS}=4.5V)$
- $R_{DS(ON)} < 50m\Omega (V_{GS} = 4.5V)$
- $R_{DS(ON)} < 63m\Omega (V_{GS} = 2.5V)$
- $R_{DS(ON)} < 87m\Omega (V_{GS} = 1.8V)$

MARKING

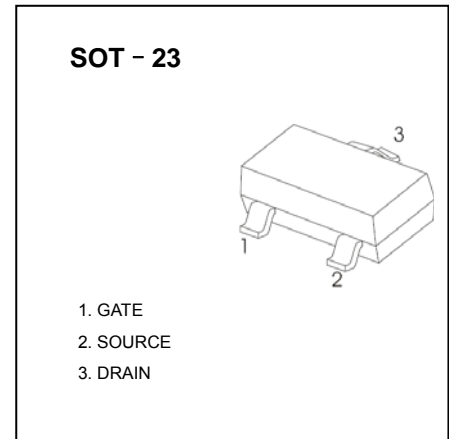
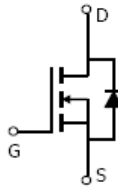
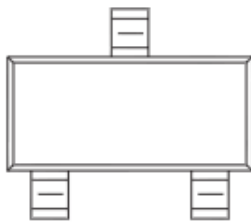

■ Absolute Maximum Ratings  $T_a = 25^\circ C$

Parameter	Symbol	Rating	Unit
Drain-Source Voltage	$V_{DS}$	20	V
Gate-Source Voltage	$V_{GS}$	$\pm 8$	V
Continuous Drain Current *1 $T_A=25^\circ C$	$I_D$	4.2	A
Current *1 $T_A=70^\circ C$		3.2	
Pulsed Drain Current *2	$I_{DM}$	15	
Power Dissipation *1 $T_A=25^\circ C$	$P_D$	1.4	W
$T_A=70^\circ C$		0.9	
Thermal Resistance.Junction-to-Ambient *1	$R_{thJA}$	125	$^\circ C/W$
Thermal Resistance.Junction-to-Case	$R_{thJC}$	80	$^\circ C/W$
Junction and Storage Temperature Range	$T_J, T_{STG}$	-55 to 150	$^\circ C$

\*1The value of  $R_{thJA}$  is measured with the device mounted on  $1in^2$  FR-4 board with 2oz.

Copper, in a still air environment with  $T_A = 25^\circ C$

## ■ Electrical Characteristics Ta = 25°C

Parameter	Symbol	Testconditions	Min	Typ	Max	Unit
Drain-Source Breakdown Voltage	V <sub>DSS</sub>	I <sub>D</sub> =250uA, V <sub>GS</sub> =0V	20			V
Zero Gate Voltage Drain Current	I <sub>DSS</sub>	V <sub>DS</sub> =16V, V <sub>GS</sub> =0V			1	μ A
		V <sub>DS</sub> =16V, V <sub>GS</sub> =0V, T <sub>J</sub> =55°C			5	
Gate-Body leakage current	I <sub>GSS</sub>	V <sub>DS</sub> =0V, V <sub>GS</sub> =±8V			±100	nA
Gate Threshold Voltage	V <sub>GS(th)</sub>	V <sub>DS</sub> =V <sub>GS</sub> I <sub>D</sub> =250uA	0.4	0.6	1	V
Static Drain-Source On-Resistance	R <sub>DS(ON)</sub>	V <sub>GS</sub> =4.5V, I <sub>D</sub> =4.2A		41	50	m Ω
		V <sub>GS</sub> =4.5V, I <sub>D</sub> =4.2A T <sub>J</sub> =125°C		58	70	
		V <sub>GS</sub> =2.5V, I <sub>D</sub> =3.7A		52	63	
		V <sub>GS</sub> =1.8V, I <sub>D</sub> =3.2A		67	87	
On state drain current	I <sub>D(ON)</sub>	V <sub>GS</sub> =4.5V, V <sub>DS</sub> =5V	15			A
Forward Transconductance	g <sub>FS</sub>	V <sub>DS</sub> =5V, I <sub>D</sub> =4.2A		11		S
Input Capacitance	C <sub>iss</sub>	V <sub>GS</sub> =0V, V <sub>DS</sub> =-10V, f=1MHz		436		pF
Output Capacitance	C <sub>oss</sub>			66		pF
Reverse Transfer Capacitance	C <sub>rss</sub>			44		pF
Gate resistance	R <sub>g</sub>		V <sub>GS</sub> =0V, V <sub>DS</sub> =0V, f=1MHz		3	
Total Gate Charge	Q <sub>g</sub>	V <sub>GS</sub> =4.5V, V <sub>DS</sub> =-10V, I <sub>D</sub> =4.2A		6.2		nC
Gate Source Charge	Q <sub>gs</sub>			1.6		nC
Gate Drain Charge	Q <sub>gd</sub>			0.5		nC
Turn-On DelayTime	t <sub>D(on)</sub>		V <sub>GS</sub> =4.5V, V <sub>DS</sub> =10V, R <sub>L</sub> =2.7Ω, R <sub>GEN</sub> =6Ω		5.5	
Turn-On Rise Time	t <sub>r</sub>			6.3		ns
Turn-Off DelayTime	t <sub>D(off)</sub>			40		ns
Turn-Off FallTime	t <sub>f</sub>			12.7		ns
Body Diode Reverse Recovery Time	t <sub>rr</sub>	I <sub>F</sub> =4A, di/dt=100A/μ s			12.3	
Body Diode Reverse Recovery Charge	Q <sub>rr</sub>	I <sub>F</sub> =4A, di/dt=100A/μ s		3.5		nC
Maximum Body-Diode Continuous Current	I <sub>s</sub>				2	A
Diode Forward Voltage	V <sub>SD</sub>	I <sub>s</sub> =1A, V <sub>GS</sub> =0V		0.76	1	V

■ Typical Characteristics

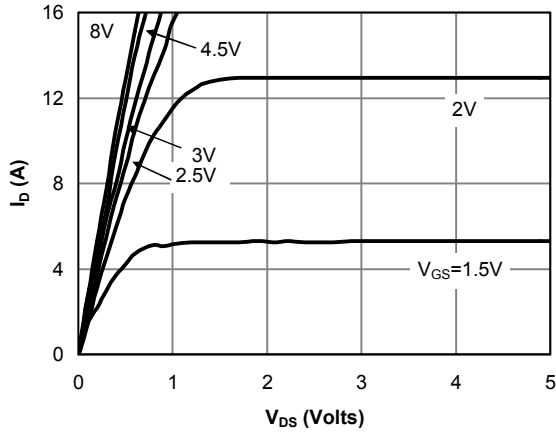

Fig 1: On-Region Characteristics

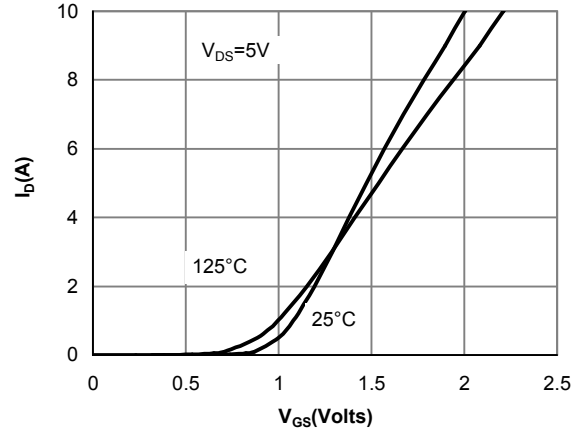

Figure 2: Transfer Characteristics

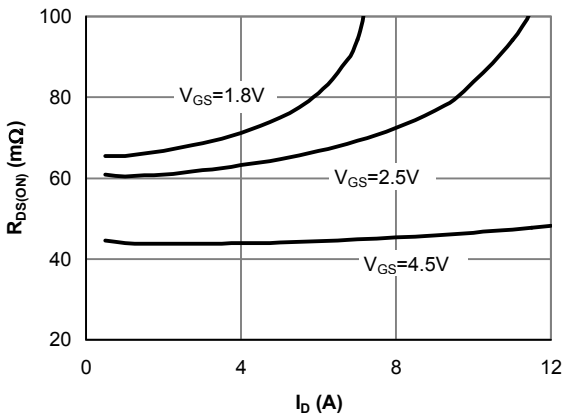

Figure 3: On-Resistance vs. Drain Current and Gate Voltage

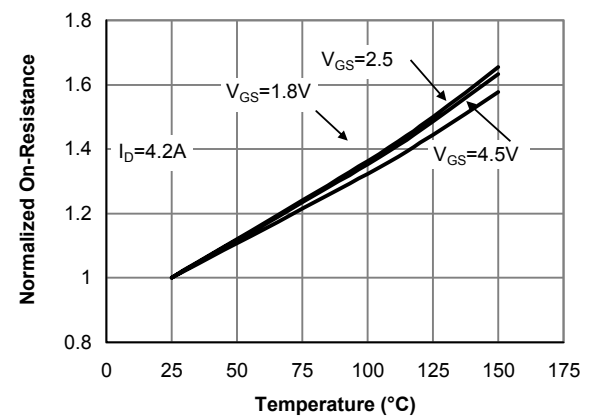

Figure 4: On-Resistance vs. Junction Temperature

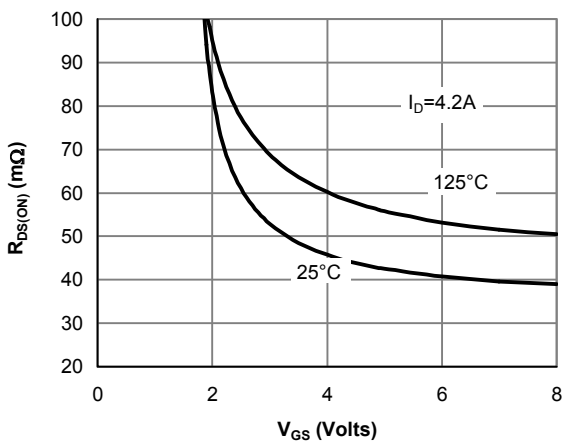

Figure 5: On-Resistance vs. Gate-Source Voltage

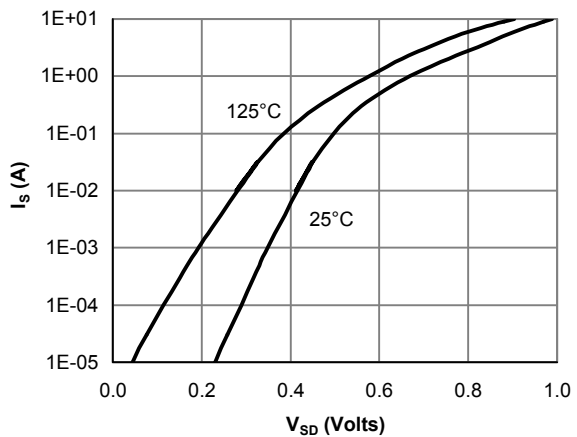

Figure 6: Body-Diode Characteristics

■ Typical Characteristics

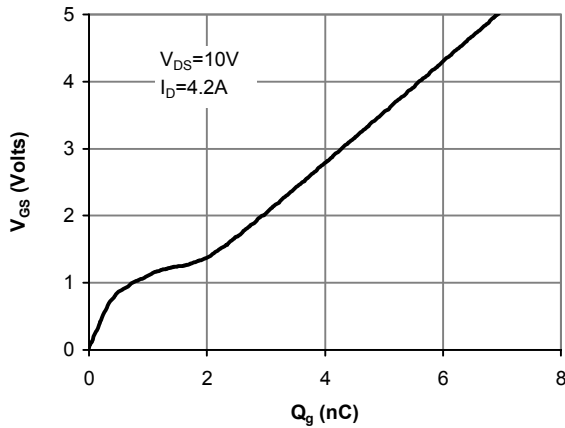

Figure 7: Gate-Charge Characteristics

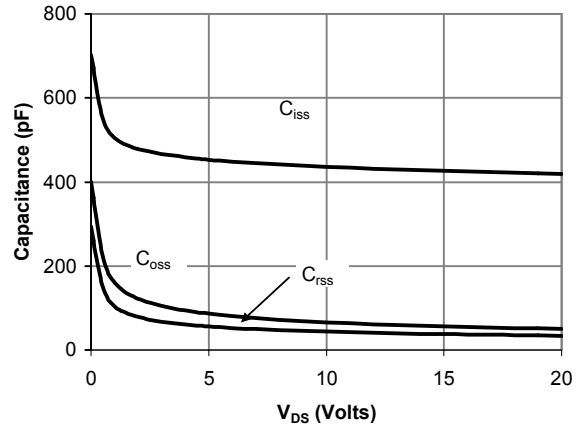

Figure 8: Capacitance Characteristics

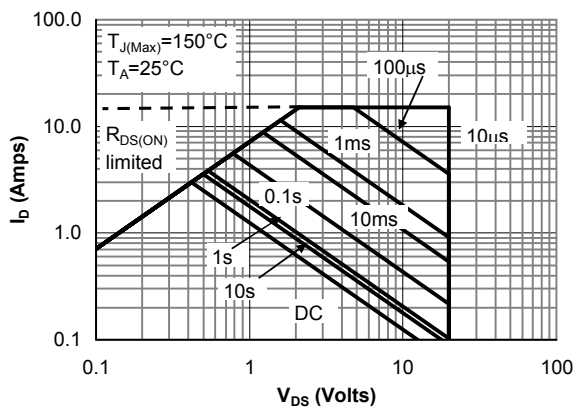

Figure 9: Maximum Forward Biased Safe Operating Area (Note E)

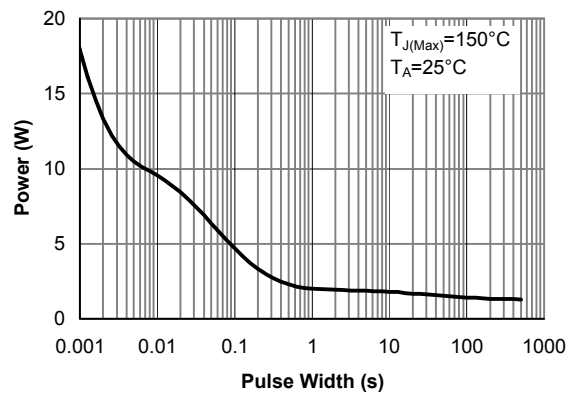

Figure 10: Single Pulse Power Rating Junction-to-Ambient (Note E)

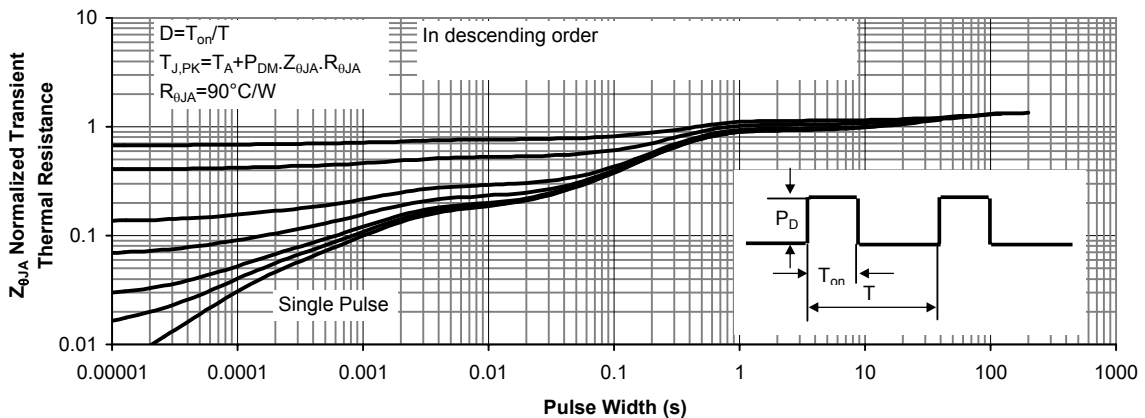
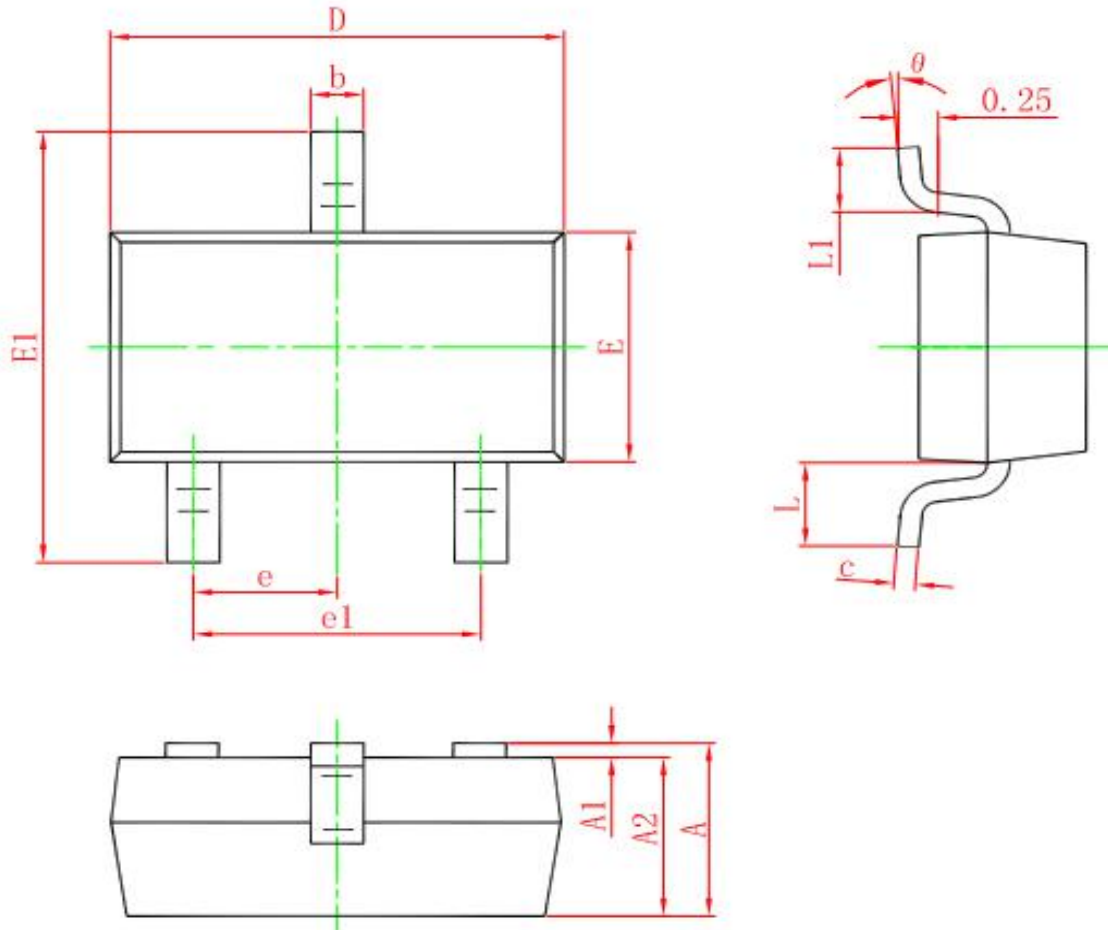

Figure 11: Normalized Maximum Transient Thermal Impedance

**SOT-23 PACKAGE OUTLINE DIMENSIONS**



Symbol	Dimensions In Millimeters		Dimensions In Inches	
	Min.	Max.	Min.	Max.
A	0.900	1.150	0.035	0.045
A1	0.000	0.100	0.000	0.004
A2	0.900	1.050	0.035	0.041
b	0.300	0.500	0.012	0.020
c	0.080	0.150	0.003	0.006
D	2.800	3.000	0.110	0.118
E	1.200	1.400	0.047	0.055
E1	2.250	2.550	0.089	0.100
e	0.950 TYP.		0.037 TYP.	
e1	1.800	2.000	0.071	0.079
L	0.550 REF.		0.022 REF.	
L1	0.300	0.500	0.012	0.020
θ	0°	8°	0°	8°

单击下面可查看定价，库存，交付和生命周期等信息

[>>UMW\(友台半导体\)](#)