

General Description

This Power MOSFET is designed to withstand high energy in the avalanche and commutation modes. Designed for low-voltage, high-speed switching applications in power supplies, converters, and power motor controls, these devices are particularly well suited for bridge circuits where diode speed and commutating safe operating areas are critical and offer an additional safety margin against unexpected voltage transients.

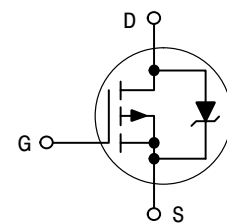
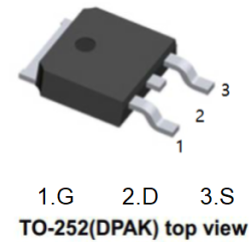

Features

- V_{DS} (V) = -60V
- $R_{DS(on)} = 150\text{ m}\Omega$ ($V_{GS} = -10\text{V}$)
- $I_D = -12\text{A}$ ($V_{GS} = -10\text{V}$)
- Avalanche Energy Specified
- I_{DSS} and $V_{DS(on)}$ Specified at Elevated Temperature
- Designed for Low-Voltage, High-Speed Switching Applications and to Withstand High Energy in the Avalanche and Commutation Modes

MAXIMUM RATINGS ($T_J = 25^\circ\text{C}$ unless otherwise noted)

Rating	Symbol	Value	Unit
Drain-to-Source Voltage	V_{DSS}	-60	Vdc
Gate-to-Source Voltage	V_{GS}	± 20	Vdc
- Continuous	V_{GS}	± 25	Vpk
- Non-repetitive ($t_p \leq 10\text{ ms}$)	V_{GSM}		
Drain Current	I_D	-12	A dc
- Continuous @ $T_a = 25^\circ\text{C}$	I_{DM}	-36	A pk
- Single Pulse ($t_p \leq 10\text{ ms}$)			
Total Power Dissipation @ $T_a = 25^\circ\text{C}$	P_D	55	W
Operating and Storage Temperature Range	T_J, T_{stg}	-55 to 175	$^\circ\text{C}$
Single Pulse Drain-to-Source Avalanche Energy - Starting $T_J = 25^\circ\text{C}$ ($V_{DD} = 25\text{ Vdc}$, $V_{GS} = 10\text{ Vdc}$, Peak $I_L = 12\text{ Apk}$, $L = 3.0\text{ mH}$, $R_G = 25\ \Omega$)	E_{AS}	216	mJ
Thermal Resistance	$R_{\theta JC}$	2.73	$^\circ\text{C/W}$
- Junction-to-Case	$R_{\theta JA}$	71.4	
- Junction-to-Ambient (Note 1)	$R_{\theta JA}$	100	
- Junction-to-Ambient (Note 2)			
Maximum Lead Temperature for Soldering Purposes, 1/8 in. from case for 10 seconds	T_L	260	$^\circ\text{C}$

Maximum ratings are those values beyond which device damage can occur. Maximum ratings applied to the device are individual stress limit values (not normal operating conditions) and are not valid simultaneously. If these limits are exceeded, device functional operation is not implied, damage may occur and reliability may be affected.

1. When surface mounted to an FR4 board using 1 in pad size (Cu area = 1.127 in²).
2. When surface mounted to an FR4 board using the minimum recommended pad size (Cu area = 0.412 in²).

ELECTRICAL CHARACTERISTICS ($T_J = 25^\circ\text{C}$ unless otherwise noted)

Characteristic	Symbol	Min	Typ	Max	Unit
OFF CHARACTERISTICS					
Drain-to-Source Breakdown Voltage (Note 3) ($V_{GS} = 0\text{ Vdc}$, $I_D = -0.25\text{ mA}$) (Positive Temperature Coefficient)	$V_{(BR)DSS}$	-60 -	- 67		Vdc mV/ $^\circ\text{C}$
Zero Gate Voltage Drain Current ($V_{GS} = 0\text{ Vdc}$, $V_{DS} = -60\text{ Vdc}$, $T_J = 25^\circ\text{C}$) ($V_{GS} = 0\text{ Vdc}$, $V_{DS} = -60\text{ Vdc}$, $T_J = 150^\circ\text{C}$)	I_{DSS}			-10 -100	μAdc
Gate-Body Leakage Current ($V_{GS} = \pm 20\text{ Vdc}$, $V_{DS} = 0\text{ Vdc}$)	I_{GSS}			-100	nAdc

ON CHARACTERISTICS (Note 3)

Gate Threshold Voltage ($V_{DS} = V_{GS}$, $I_D = -250\ \mu\text{Adc}$) (Negative Temperature Coefficient)	$V_{GS(th)}$	-1.1	-2.0	-3.0	Vdc mV/ $^\circ\text{C}$
Static Drain-Source On-State Resistance ($V_{GS} = -10\text{ Vdc}$, $I_D = -6.0\text{ Adc}$)	$R_{DS(on)}$		150	170	$\text{m}\Omega$
Drain-to-Source On-Voltage ($V_{GS} = -10\text{ Vdc}$, $I_D = -12\text{ Adc}$) ($V_{GS} = -10\text{ Vdc}$, $I_D = -6.0\text{ Adc}$, $T_J = 150^\circ\text{C}$)	$V_{DS(on)}$		-1.86 -	-2.6 -2.0	Vdc
Forward Transconductance ($V_{DS} = 10\text{ Vdc}$, $I_D = 6.0\text{ Adc}$)	g_{FS}		8.0		Mhos

DYNAMIC CHARACTERISTICS

Input Capacitance	$(V_{DS} = -25\text{ Vdc}$, $V_{GS} = 0\text{ Vdc}$, $F = 1.0\text{ MHz}$)	C_{iss}		500	750	pF
Output Capacitance		C_{oss}		150	250	
Reverse Transfer Capacitance		C_{rss}		50	100	

SWITCHING CHARACTERISTICS (Notes 3 and 4)

Turn-On Delay Time	$(V_{DD} = -30\text{ Vdc}$, $I_D = -12\text{ A}$, $V_{GS} = -10\text{ V}$, $R_G = 9.1\ \Omega$)	$t_{d(on)}$		10	20	ns
Rise Time		t_r		45	85	
Turn-Off Delay Time		$t_{d(off)}$		26	40	
Fall Time		t_f		48	90	
Gate Charge	$(V_{DS} = -48\text{ Vdc}$, $V_{GS} = -10\text{ Vdc}$, $I = -12\text{ A}$)	Q_T		15	30	nC
		Q_{GS}		4.0		
		Q_{GD}		7.0		

DRAIN-SOURCE DIODE CHARACTERISTICS (Note 3)

Diode Forward On-Voltage ($I_S = 12\text{ Adc}$, $V_{GS} = 0\text{ V}$) ($I_S = 12\text{ Adc}$, $V_{GS} = 0\text{ V}$, $T_J = 150^\circ\text{C}$)	V_{SD}		-1.6 -1.3	-2.5 -	Vdc
Reverse Recovery Time ($I_S = 12\text{ A}$, $di_S/dt = 100\text{ A}/\mu\text{s}$, $V_{GS} = 0\text{ V}$)	t_{rr}		50		ns
	t_a		40		
	t_b		10		
Reverse Recovery Stored Charge	Q_{RR}		0.10		μC

3. Indicates Pulse Test: Pulse Width $\leq 300\ \mu\text{s}$, Duty Cycle $\leq 2\%$.

4. Switching characteristics are independent of operating junction temperature.

TYPICAL PERFORMANCE CURVES ($T_J = 25^\circ\text{C}$ unless otherwise noted)

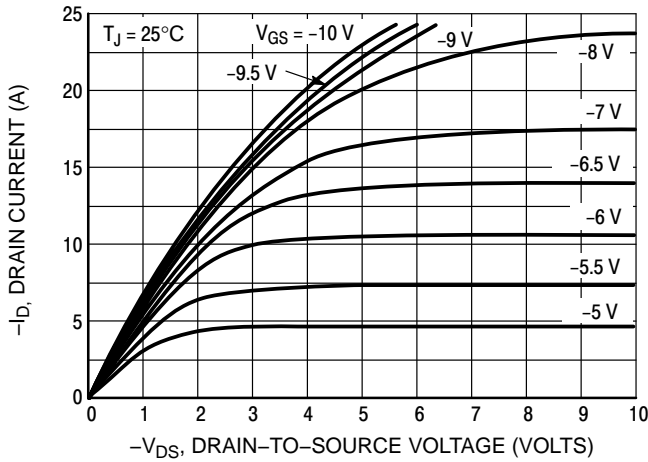

Figure 1. On-Region Characteristics

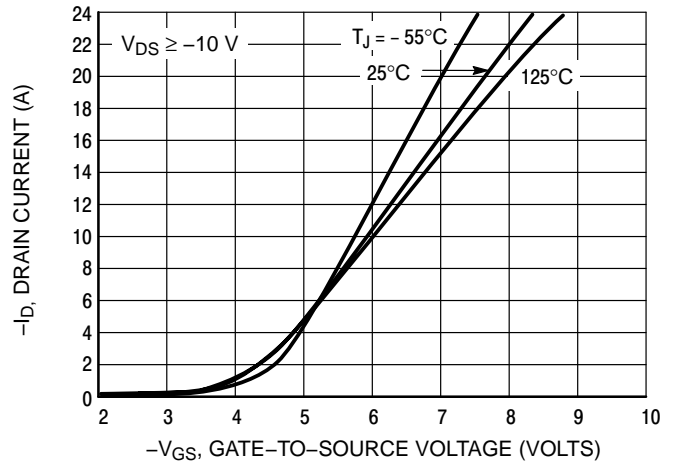

Figure 2. Transfer Characteristics

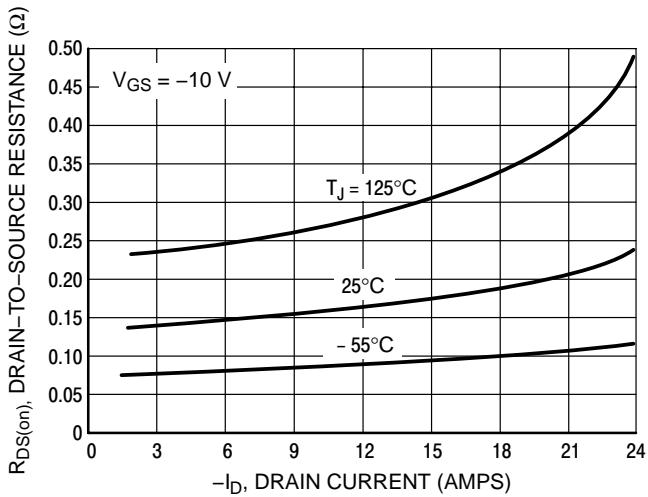

Figure 3. On-Resistance versus Drain Current and Temperature

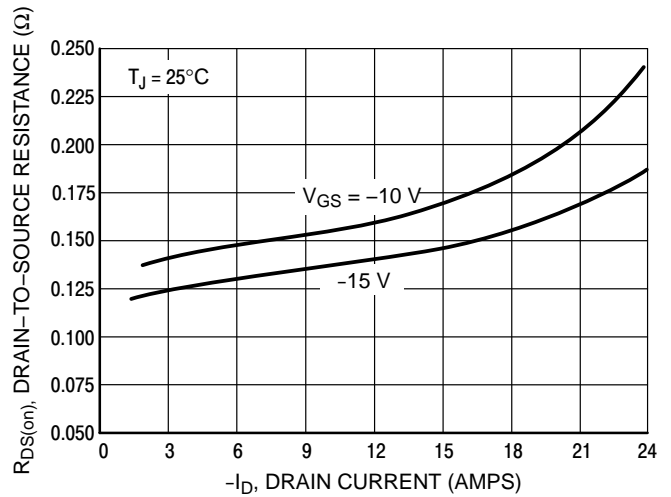

Figure 4. On-Resistance versus Drain Current and Gate Voltage

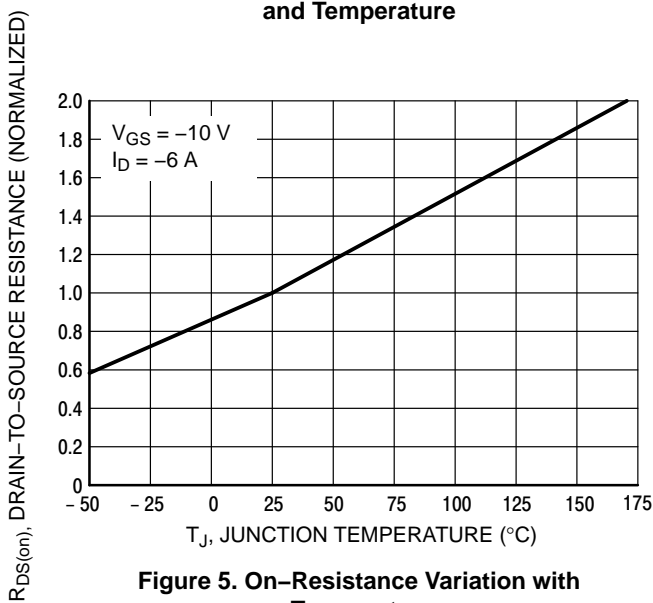

Figure 5. On-Resistance Variation with Temperature

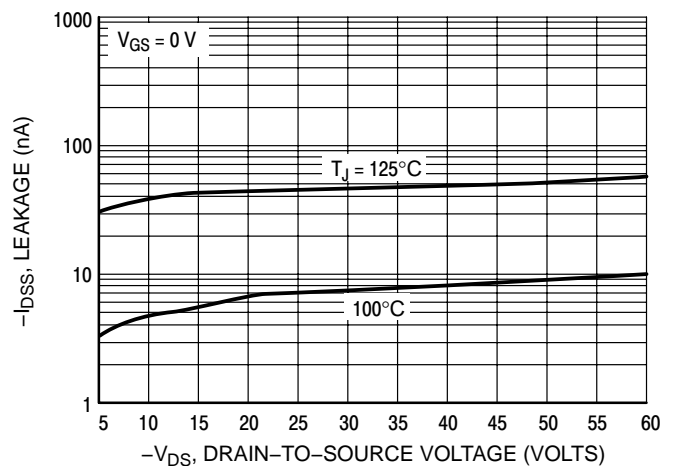

Figure 6. Drain-To-Source Leakage Current versus Voltage

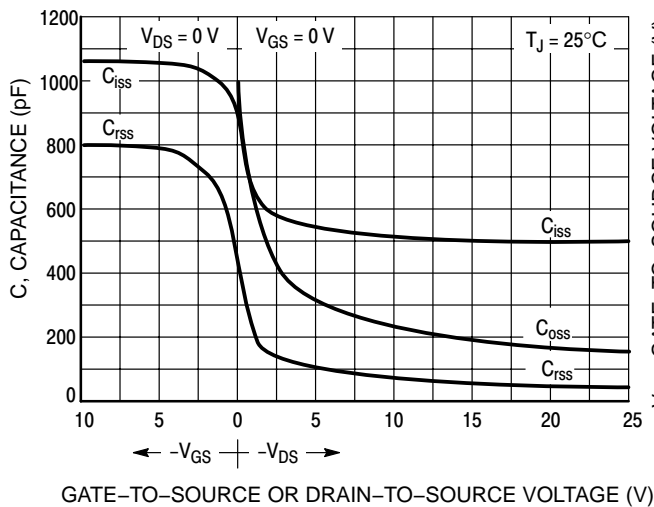

Figure 7. Capacitance Variation

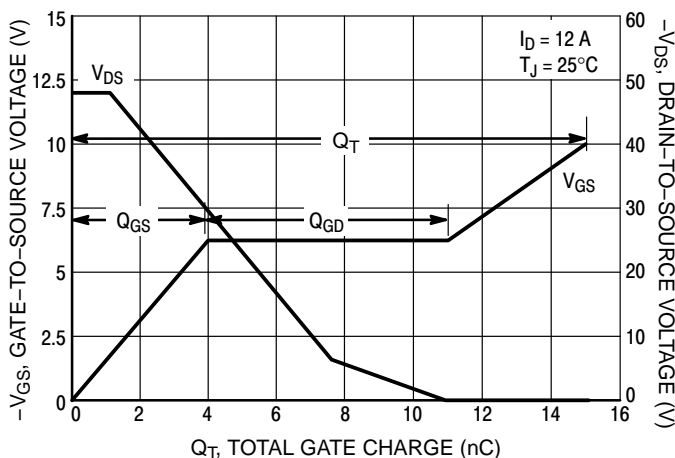

Figure 8. Gate-To-Source and Drain-To-Source Voltage versus Total Charge

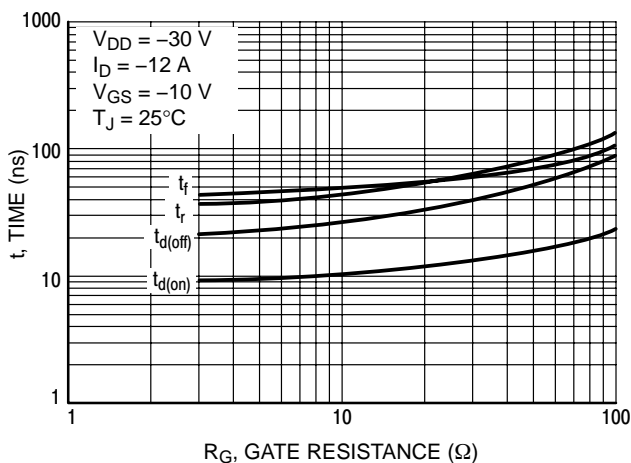

Figure 9. Resistive Switching Time Variation versus Gate Resistance

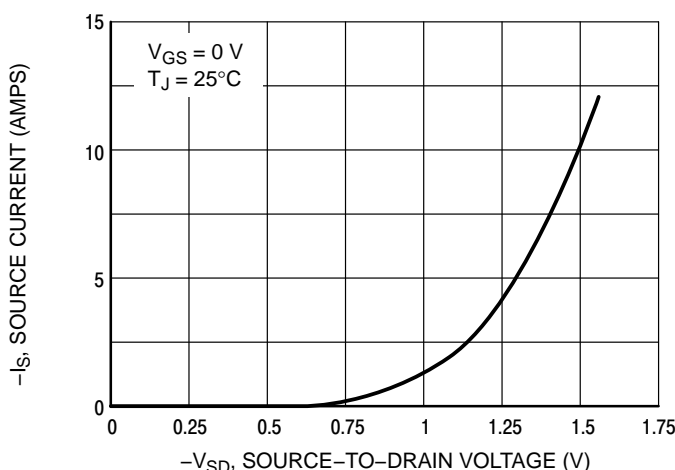

Figure 10. Diode Forward Voltage versus Current

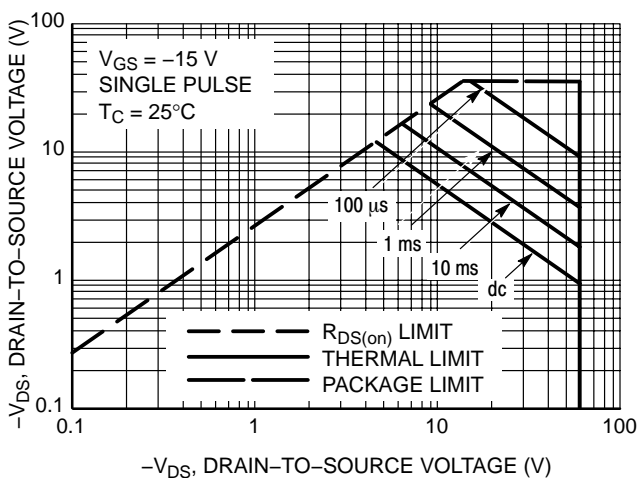

Figure 11. Maximum Rated Forward Biased Safe Operating Area

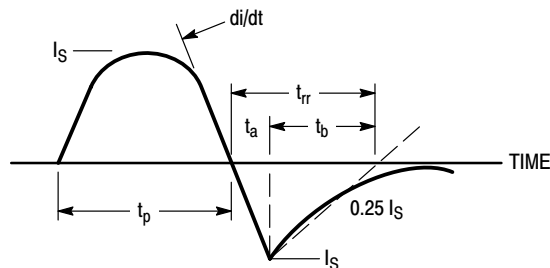

Figure 12. Diode Reverse Recovery Waveform

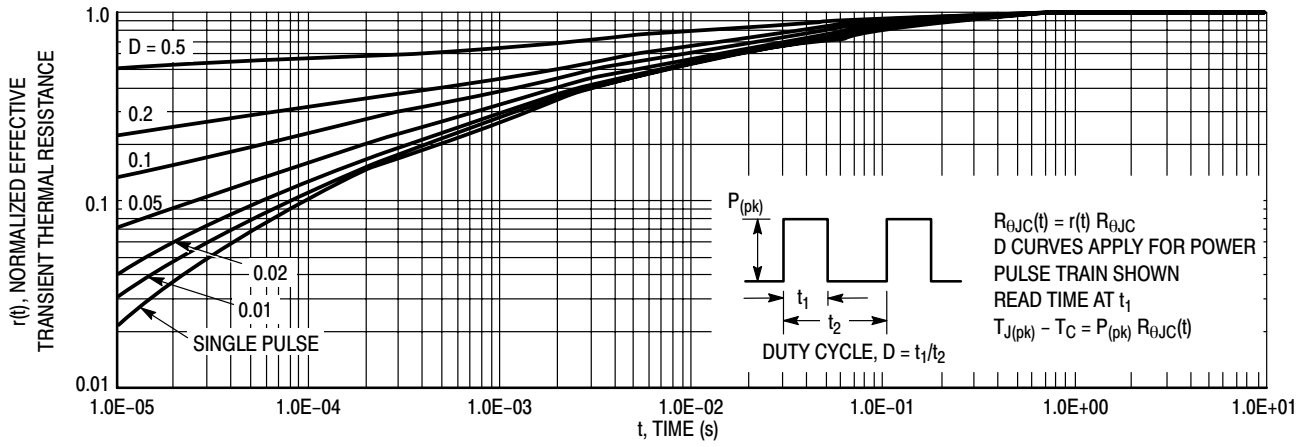
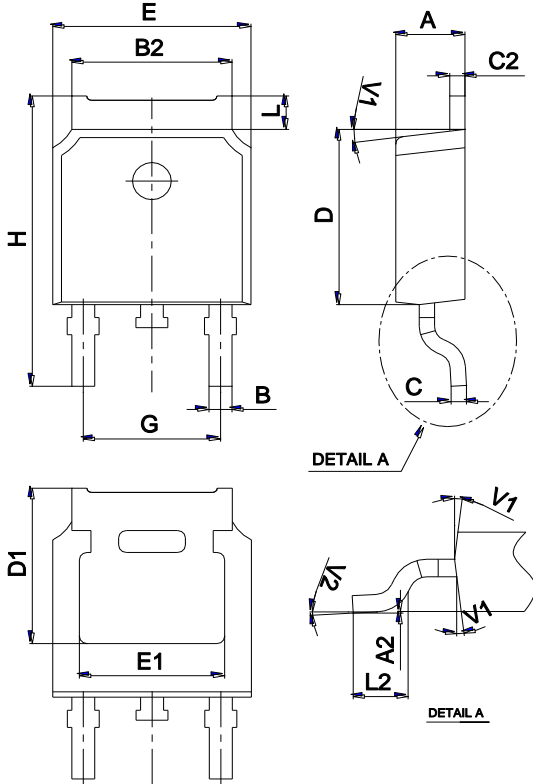

Figure 13. Thermal Response

Package Mechanical Data TO-252



Ref.	Dimensions					
	Millimeters			Inches		
	Min.	Typ.	Max.	Min.	Typ.	Max.
A	2.10		2.50	0.083		0.098
A2	0		0.10	0		0.004
B	0.66		0.86	0.026		0.034
B2	5.18		5.48	0.202		0.216
C	0.40		0.60	0.016		0.024
C2	0.44		0.58	0.017		0.023
D	5.90		6.30	0.232		0.248
D1	5.30REF			0.209REF		
E	6.40		6.80	0.252		0.268
E1	4.63			0.182		
G	4.47		4.67	0.176		0.184
H	9.50		10.70	0.374		0.421
L	1.09		1.21	0.043		0.048
L2	1.35		1.65	0.053		0.065
V1		7°			7°	
V2	0°		6°	0°		6°

Marking

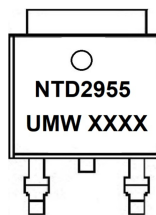

Ordering information

Order code	Package	Baseqty	Deliverymode
UMW NTD2955T4G	TO-252	2500	Tape and reel

单击下面可查看定价，库存，交付和生命周期等信息

[>>UMW\(友台半导体\)](#)