

60V N-Channel Enhancement Mode Power MOSFET

General Description

The UMW IRLR2905TR uses advanced trench technology and design to provide excellent $R_{DS(ON)}$ with low gate charge. It can be used in a wide variety of applications.

Features

- $V_{DS} = 60V, I_D = 30A$
 $R_{DS(ON)}, 23m\Omega$ (Typ) @ $V_{GS} = 10V$
 $R_{DS(ON)}, 29m\Omega$ (Typ) @ $V_{GS} = 4.5V$
- Advanced Trench Technology
- Excellent $R_{DS(ON)}$ and Low Gate Charge
- Lead free product is acquired

Application

- Load Switch
- PWM Application
- Power management

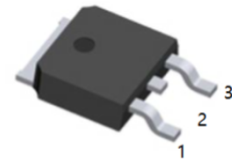

1.G 2.D 3.S
TO-252(DPAK) top view

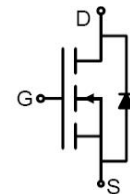

Schematic Diagram

Absolute Maximum Ratings(TA=25°C unless otherwise noted)

Parameter		Symbol	Value	Unit
Drain-Source Voltage		V_{DS}	60	V
Gate-Source Voltage		V_{GS}	±20	V
Drain Current-Continuous ^{Note3}	TC=25°C	I_D	30	A
	TC=100°C		20	A
Drain Current-Pulsed ^{Note1}		I_{DM}	120	A
Avalanche Energy ^{Note4}		E_{AS}	72	mJ
Maximum Power Dissipation	TC=25°C	P_D	55	W
Storage Temperature Range		T_{STG}	-55 to +150	°C
Operating Junction Temperature Range		T_J	-55 to +150	°C

Thermal Resistance

Parameter	Symbol	Min.	Typ.	Max	Unit
Thermal Resistance, Junction-to-Case	$R_{\theta JC}$	-	-	2.7	°C/W

60V N-Channel Enhancement Mode Power MOSFET
Electrical Characteristics(T_J=25°C unless otherwise noted)

OFF CHARACTERISTICS						
Parameter	Symbol	Conditions	Min.	Typ.	Max.	Unit
Drain-Source Breakdown Voltage	BV _{DSS}	V _{GS} =0V, I _{DS} =250uA	60	-	-	V
Zero Gate Voltage Drain Current	I _{DSS}	V _{DS} =60V, V _{GS} =0V	-	-	1	uA
Gate-Body Leakage	I _{GSS}	V _{GS} =±20V, V _{DS} =0V	-	-	±100	nA

ON CHARACTERISTICS						
Parameter	Symbol	Conditions	Min.	Typ.	Max.	Unit
Gate Threshold Voltage	V _{GS(TH)}	V _{DS} =V _{GS} , I _{DS} =250uA	1.0	1.6	2.5	V
Drain-Source On-State Resistance	R _{DS(ON)}	V _{GS} =10V, I _{DS} =15A	-	23	29	mΩ
		V _{GS} =4.5V, I _{DS} =10A	-	29	40	mΩ

DYNAMIC CHARACTERISTICS						
Parameter	Symbol	Conditions	Min.	Typ.	Max.	Unit
Input Capacitance	C _{ISS}	V _{DS} =25V, V _{GS} = 0V, f=1MHz	-	1562	-	pF
Output Capacitance	C _{OSS}		-	75.4	-	
Reverse Transfer Capacitance	C _{rss}		-	66.8	-	

SWITCHING CHARACTERISTICS						
Parameter	Symbol	Conditions	Min.	Typ.	Max.	Unit
Turn-On Delay Time	T _{d(on)}	V _{GS} =10V, V _{DS} =30V, R _{GEN} =1.8Ω I _D =15A	-	7.5	-	ns
Rise Time	t _r		-	21	-	
Turn-Off Delay Time	T _{d(off)}		-	16	-	
Fall Time	t _f		-	23.5	-	
Total Gate Charge at 10V	Q _g	V _{DS} =30V, I _{DS} =15A, V _{GS} =10V	-	25	-	nC
Gate to Source Gate Charge	Q _{gs}		-	4.5	-	
Gate to Drain"Miller"Charge	Q _{gd}		-	6.5	-	

DRAIN-SOURCE DIODE CHARACTERISTICS AND MAXIMUM RATINGS						
Parameter	Symbol	Conditions	Min.	Typ.	Max.	Unit
Drain-Source Diode Forward Voltage	V _{SD}	V _{GS} =0V, I _{DS} =15A	-	-	1.2	V
Reverse Recovery Time	t _{rr}	T _J =25°C, I _F =15A	-	29	-	nS
Reverse Recovery Charge	Q _{rr}		di/dt=100A/us	-	45	-

Notes:

- 1: Repetitive rating, pulse width limited by maximum junction temperature.
- 2: Surface mounted on FR4 Board, t_s≤10sec.
- 3: Pulse width ≤ 300μs, duty cycle ≤ 2%.
- 4: EAS condition: L=0.5mH, V_{DD}=30V, V_G=10V, V_{GATE}=60V, Start T_J=25°C.

60V N-Channel Enhancement Mode Power MOSFET

Typical Performance Characteristics

Figure 1: Output Characteristics

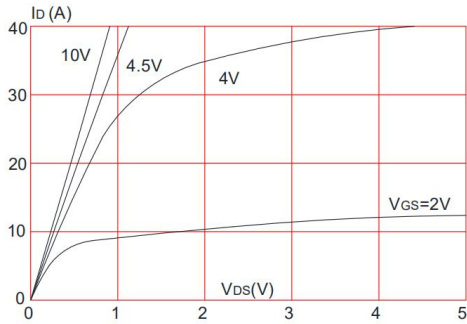

Figure 2: Typical Transfer Characteristics

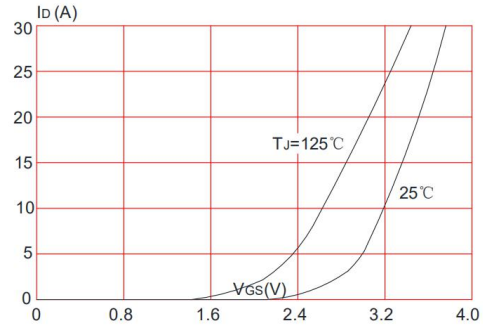

Figure 3: On-resistance vs. Drain Current

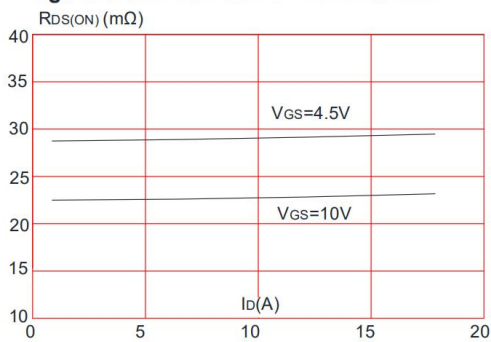

Figure 4: Body Diode Characteristics

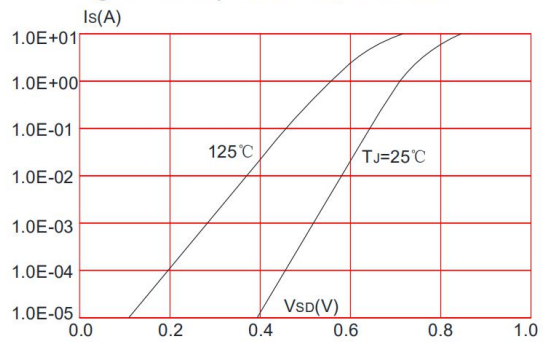

Figure 5: Gate Charge Characteristics

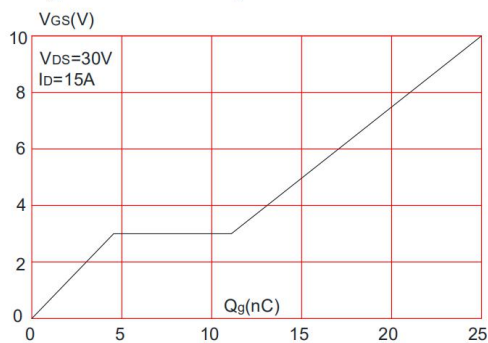
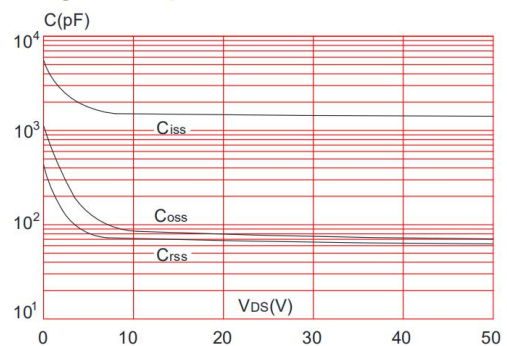

Figure 6: Capacitance Characteristics



60V N-Channel Enhancement Mode Power MOSFET

Figure 7: Normalized Breakdown Voltage vs. Junction Temperature

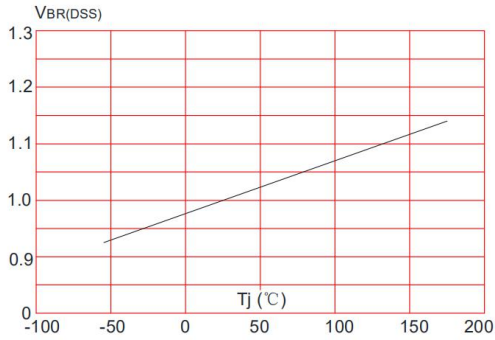

Figure 8: Normalized on Resistance vs. Junction Temperature

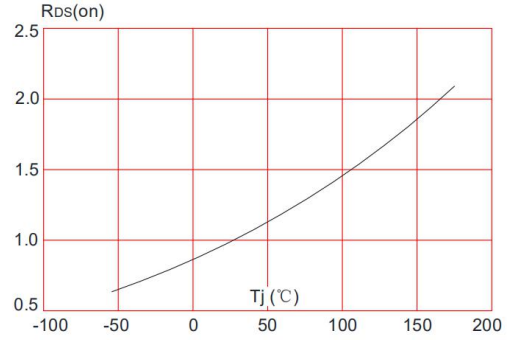

Figure 9: Maximum Safe Operating Area

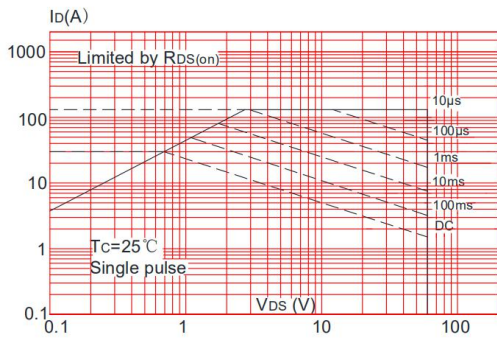

Figure 10: Maximum Continuous Drain Current vs. Case Temperature

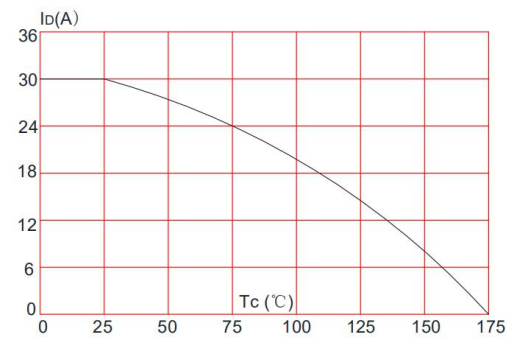
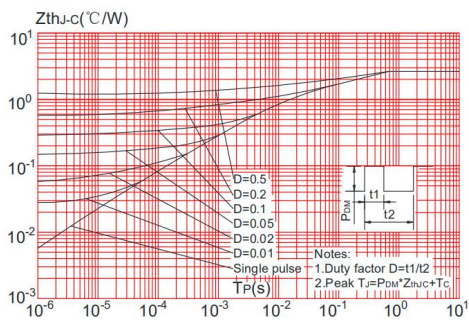

Figure.11: Maximum Effective Transient Thermal Impedance, Junction-to-Case



60V N-Channel Enhancement Mode Power MOSFET

Test Circuit

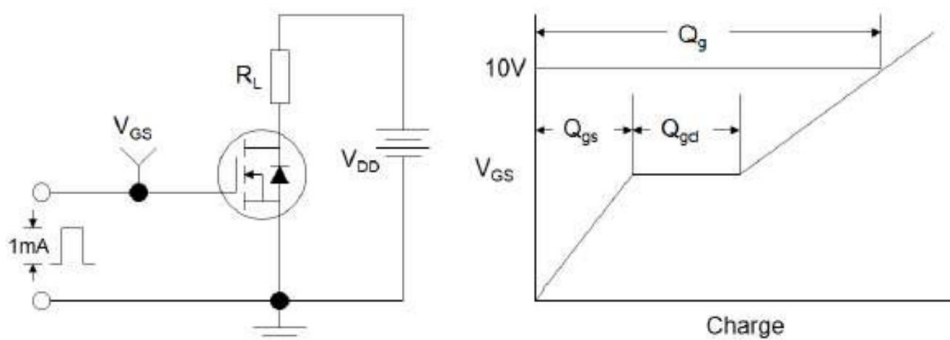

Figure1:Gate Charge Test Circuit & Waveform

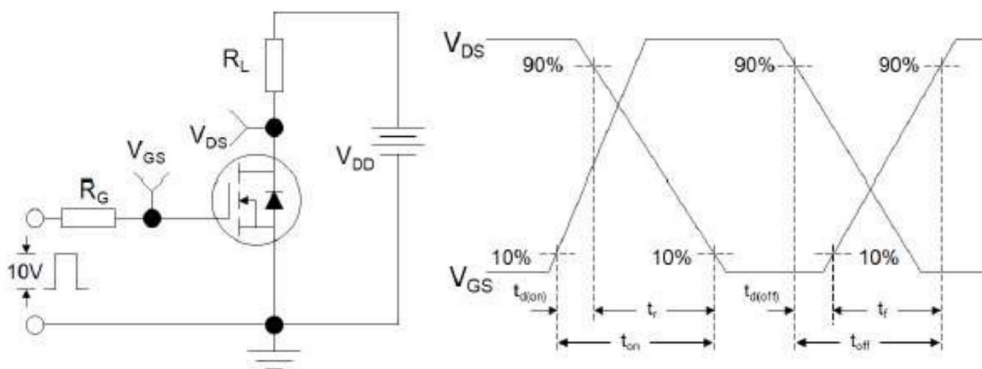

Figure 2: Resistive Switching Test Circuit & Waveforms

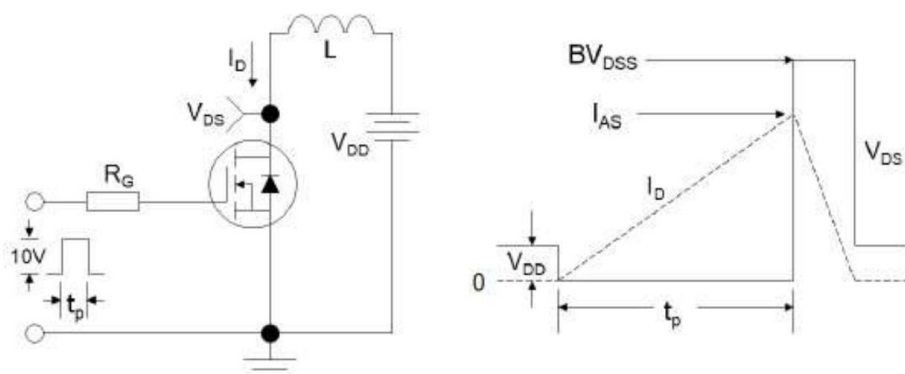
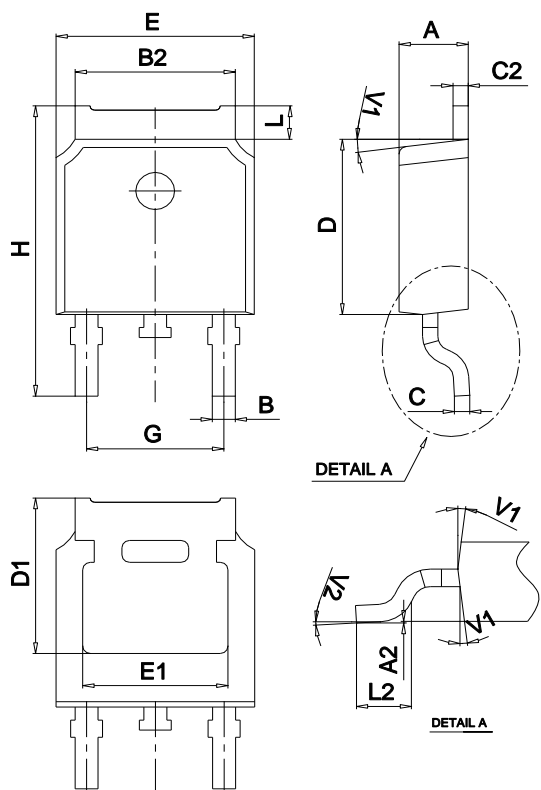

Figure 3:Unclamped Inductive Switching Test Circuit & Waveforms

Package Mechanical Data TO-252



Ref.	Dimensions					
	Millimeters			Inches		
	Min.	Typ.	Max.	Min.	Typ.	Max.
A	2.10		2.50	0.083		0.098
A2	0		0.10	0		0.004
B	0.66		0.86	0.026		0.034
B2	5.18		5.48	0.202		0.216
C	0.40		0.60	0.016		0.024
C2	0.44		0.58	0.017		0.023
D	5.90		6.30	0.232		0.248
D1	5.30REF			0.209REF		
E	6.40		6.80	0.252		0.268
E1	4.63			0.182		
G	4.47		4.67	0.176		0.184
H	9.50		10.70	0.374		0.421
L	1.09		1.21	0.043		0.048
L2	1.35		1.65	0.053		0.065
V1		7°			7°	
V2	0°		6°	0°		6°

Marking

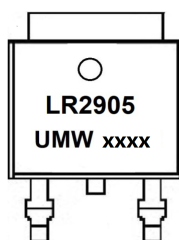

Ordering information

Order code	Package	Baseqty	Deliverymode
UMW IRLR2905TR	TO-252	2500	Tape and reel

单击下面可查看定价，库存，交付和生命周期等信息

[>>UMW\(友台半导体\)](#)