

### Summary

PS2701 is a small patch optoelectronic coupling device, suitable for surface mount production.

PS2701 is a optocoupler composed of a gallium arsenide led and a phototransistor. Its volume is smaller than dip. It is suitable for high-density surface mount applications, such as programmable controllers.

### Characteristic

- Current conversion ratio (CTR) range: 50~300% ( $I_F=5mA, V_{CE}=5V$ )
- Input output isolation voltage ( $V_{iso}=5000 V_{rms}$ )
- Collector Emitter Breakdown Voltage  $BV_{CEO} \geq 80V$
- Working temperature:  $-55 \sim 110^{\circ} C$
- UL -approved : UL 1577, File No .E 492440
- Accord with REACH and RoHS

### Application

- Switching power supply, smart meter
- Industrial control, measuring instruments
- Office equipment, such as photocopiers
- Household appliances, such as air conditioners, fans, water heaters, etc

Structural schematic diagram

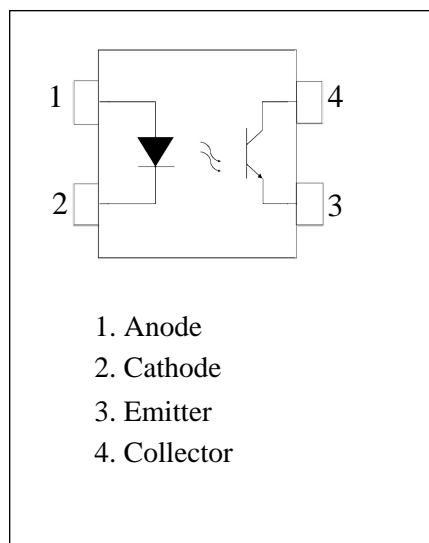

### Limit parameter (Ta=25°C)

Parameter		Symbol	Condion	Unit
Input	Forward current	$I_F$	50	mA
	Forward pulse current	$I_{FP}$	1	A
	Reverse voltage	$V_R$	6	V
	Power derating	$\Delta P_D / ^{\circ} C$	0.8	mW/ $^{\circ}C$
	Power waste	$P_D$	80	mW/ch
	Junction temperature	$T_j$	125	$^{\circ}C$
Output	Collector power consumption	$P_c$	150	mW
	Collector current	$I_c$	50	mA
	Collector Emitter Voltage	$V_{CEO}$	80	V
	Emitter collector voltage	$V_{ECO}$	7	V
	Junction temperature	$T_j$	125	$^{\circ}C$
Total power consumption		$P_{tot}$	200	mW
Isolation voltage		$V_{iso}$	5000	$V_{rms}$
working temperature		$T_{opr}$	$-55 \sim +110$	$^{\circ}C$
Storage temperature		$T_{stg}$	$-55 \sim +150$	$^{\circ}C$
welding temperature		$T_{sol}$	260 (10s)	$^{\circ}C$

Photoelectric characteristics (Ta=25°C)

Parameter		Symbol	Condition	Min.	Typ.	Max.	Unit
Input	Forward voltage	$V_F$	$I_F=5mA$		1.1	1.4	V
	Reverse current	$I_R$	$V_R=5V$			5	$\mu A$
	Input capacitance	$C_{in}$	$V=0, f=1MHz$	-	30		pF
Output	Collector dark current	$I_{CEO}$	$V_{CE}=70V$			100	nA
	Collector Emitter Breakdown Voltage	$BV_{CEO}$	$I_C=0.1mA, I_F=0$	80			V
	Emitter collector breakdown voltage	$BV_{ECO}$	$I_E=0.1mA, I_F=0$	7			V
Transmission characteristics	Current conversion ratio	CTR	$I_F=5mA, V_{CE}=5V$	50	100	300	%
	Collector Emitter Saturation Voltage Drop	$V_{CE(sat)}$	$I_F=10mA, I_C=2mA$			0.3	V
	Isolation resistance	$R_{ISO}$	DC1000V, 40~60%R.H.	$1 \times 10^{11}$			$\Omega$
	Isolation capacitance	$C_f$	$V=0, f=1MHz$		0.6	1.0	pF
	Collector Emitter capacitance	$C_{CE}$	$V=0, f=1MHz$		10		pF
	Input output capacitance	$C_S$	$V=0, f=1MHz$		0.8		pF
	cut-off frequency	$F_c$	$V_{CE}=5V, I_C=2mA, R_L=100\Omega, -3dB$		80		kHz
Switching time	Rise time	$T_r$	$V_{CE}=5V, I_C=2mA, R_L=100\Omega$	-	3		$\mu s$
	Descent time	$T_f$			5		$\mu s$

\*  $CTR = I_C / I_F \times 100\%$

CTR Classification table

Model	Grading standard	Current conversion rate(%)( $I_C/I_F$ )		
		$I_F = 5mA, V_{CE} = 5V, T_a = 25^\circ C$		
		Min	Type	Max
PS2701	M	50	-	150
	P	150	-	300
	L	200	-	350
	K	300	-	450
	LK	400	-	600

Test circuit

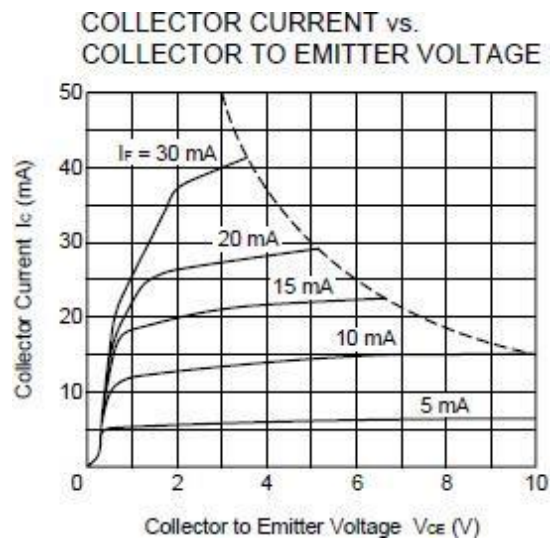
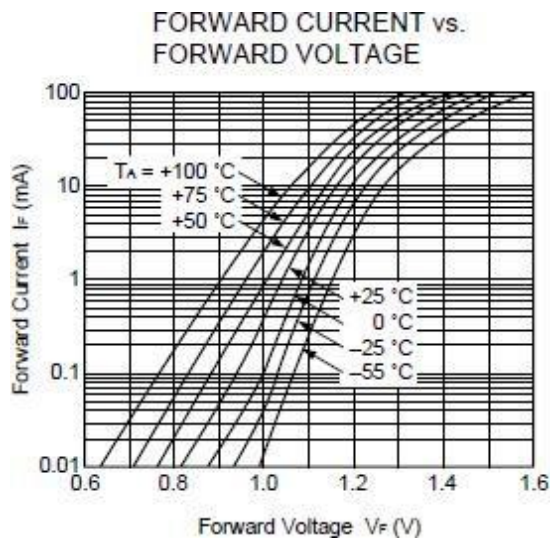
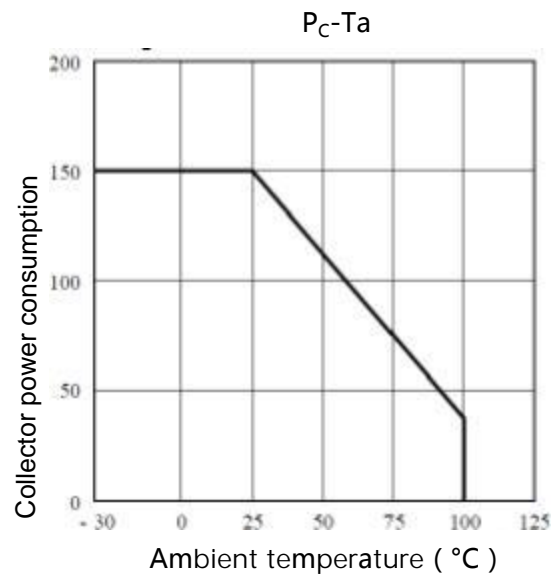
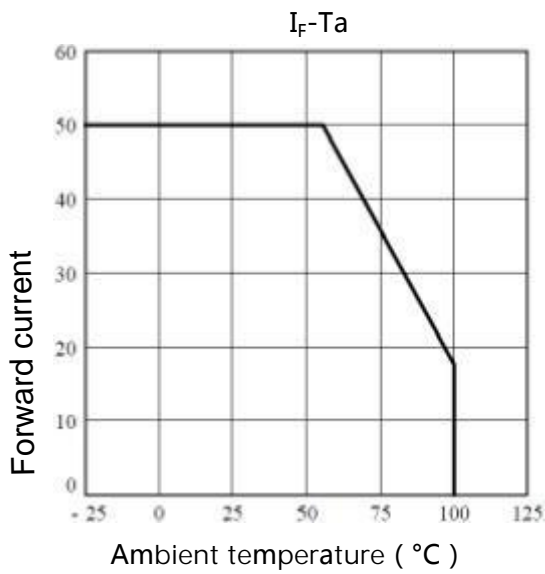
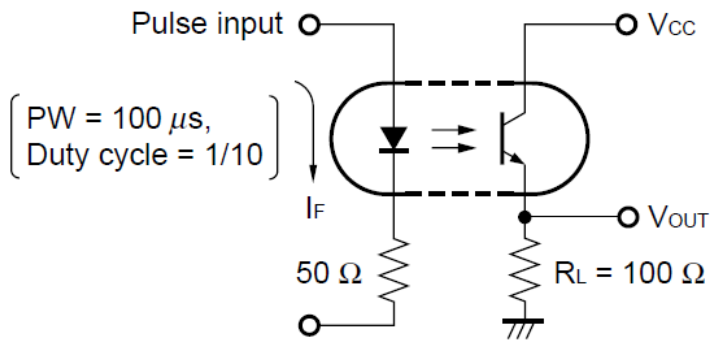

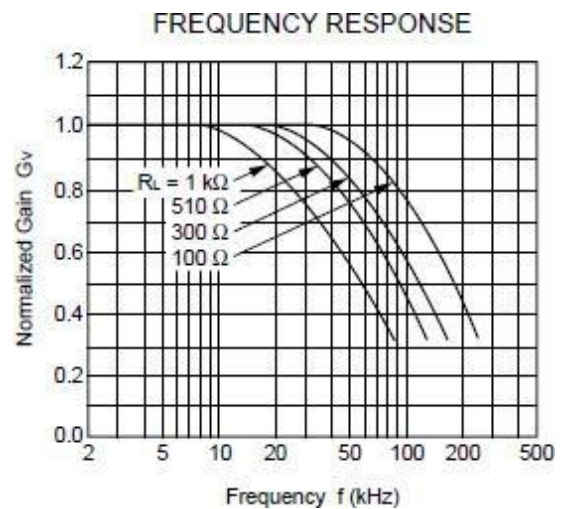
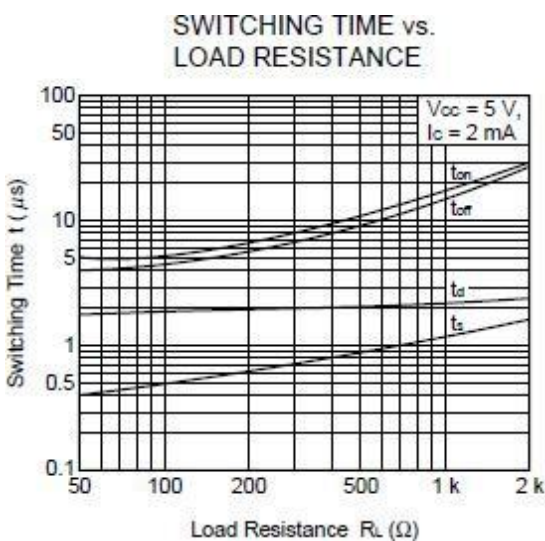
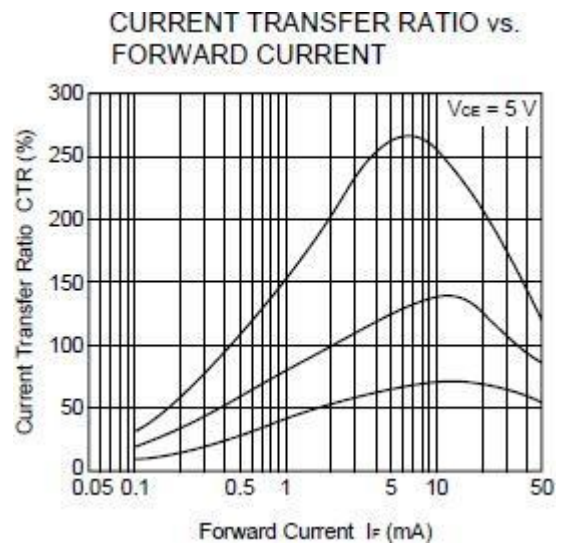
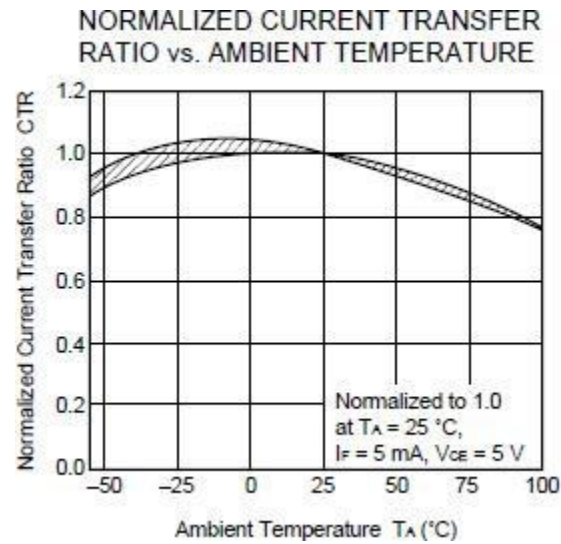
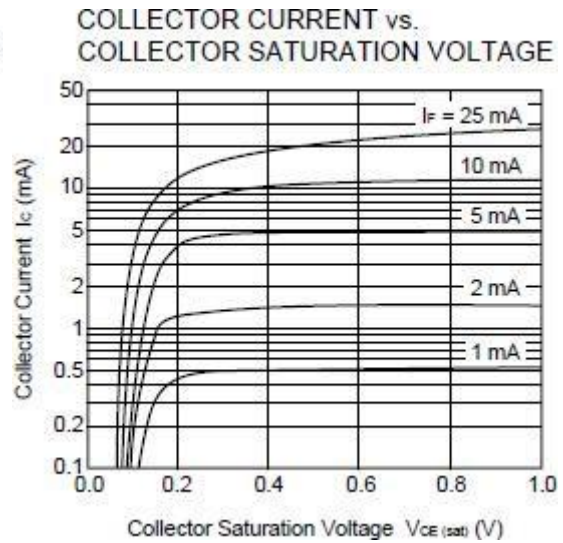
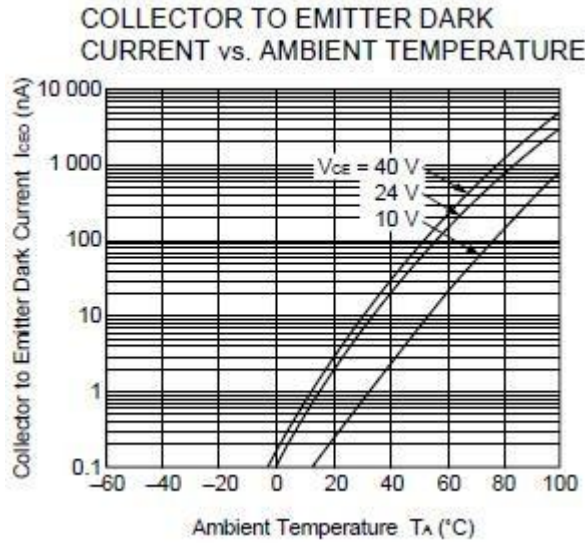

SWITCHING TIME vs. LOAD RESISTANCE

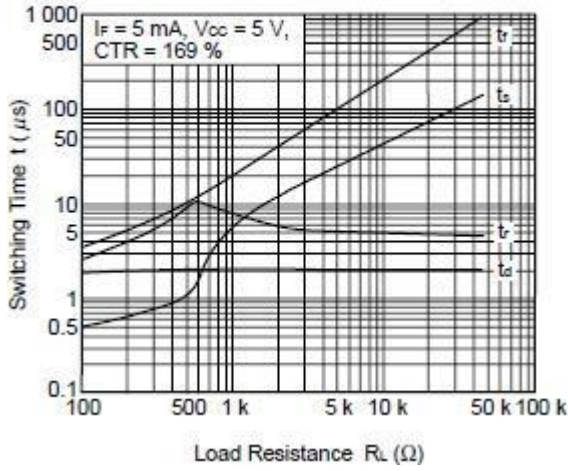

LONG TERM CTR DEGRADATION

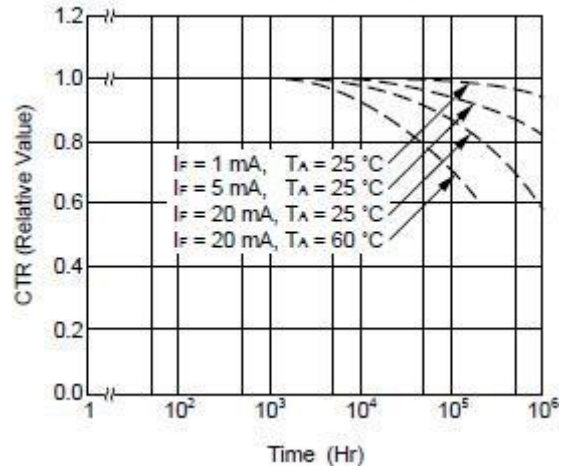

Reflow soldering temperature curve

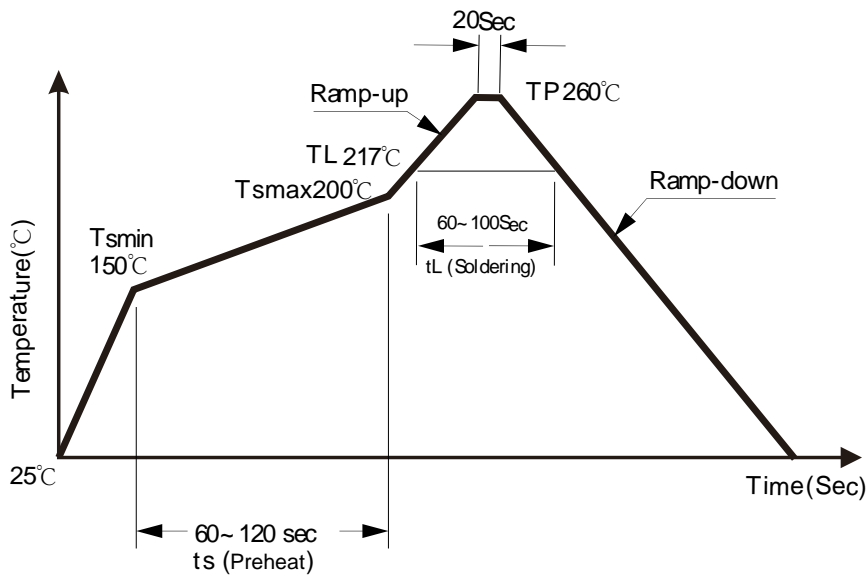

**PACKAGE OUTLINE**

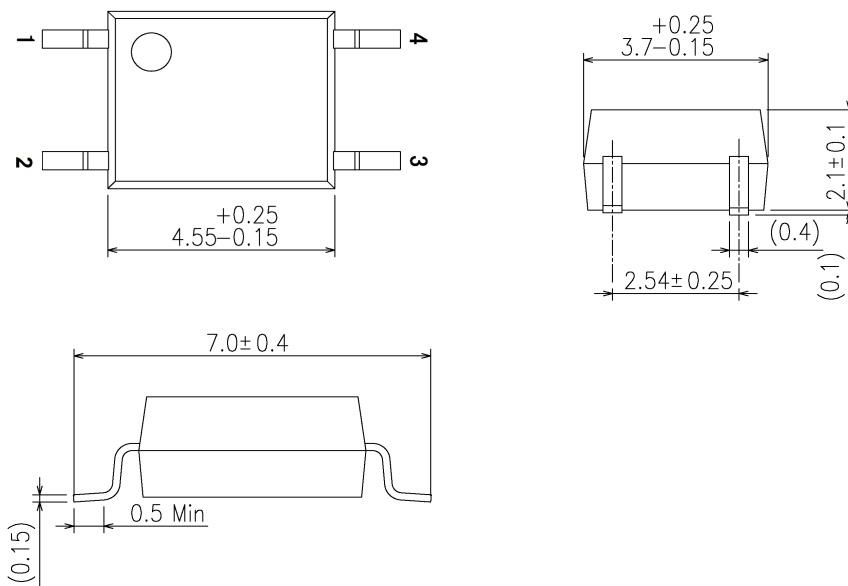

**Marking**

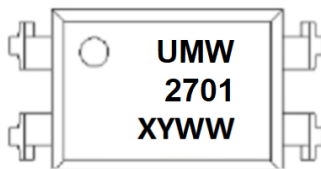

"X" : Grading standard

"YWW" : Year week number

**Ordering information**

Order Code	Package	Baseqty	Deliverymode
UMW PS2701-1-L	SOP-4	3000	Tape and reel

单击下面可查看定价，库存，交付和生命周期等信息

[>>UMW\(友台半导体\)](#)