

P-Channel Enhancement MOSFET

■ Features

- Ultra low on-resistance.
- P-Channel MOSFET.
- Fast switching.

MARKING

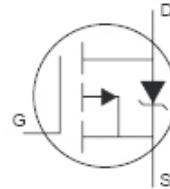
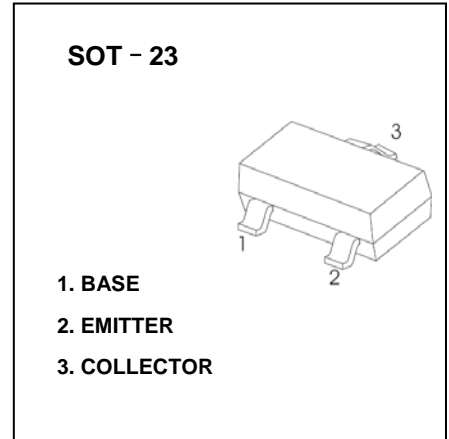
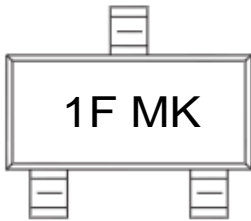

■ Absolute Maximum Ratings Ta = 25°C

Parameter	Symbol	Rating	Unit
Drain-Source Voltage	V _{DS}	-12	V
Gate-Source Voltage	V _{GS}	±8	
Continuous Drain Current V _{GS} =4.5V @ TA=25°C	I _D	-4.3	A
Continuous Drain Current V _{GS} =4.5V @ TA=70°C		-3.4	
Pulsed Drain Current a		I _{DM}	
Power Dissipation @ TA=25°C	P _D	1.3	W
Power Dissipation @ TA=70°C		0.8	
Single Pulse Avalanche Energy b	E _{AS}	33	mJ
Thermal Resistance.Junction- to-Ambient	R _{thJA}	100	°C/W
Linera Derating Factor		0.01	W/°C
Junction Temperature	T _J	150	°C
Junction and Storage Temperature Range	T _{stg}	-55 to 150	

Notes:

a.Repetitive Rating :Pulse width limited by maximum junction temperature

b.Starting T_J=25°C, L=3.5mH, R_G=25Ω, I_{AS}=-4.3A

P-Channel Enhancement MOSFET
■ Electrical Characteristics Ta = 25°C

Parameter	Symbol	Test Conditions	Min	Typ	Max	Unit
Drain-Source Breakdown Voltage	V _{DSS}	I _D =-250 μA, V _{GS} =0V	-12			V
Zero Gate Voltage Drain Current	I _{DSS}	V _{DS} =-12V, V _{GS} =0V			-1	μA
		V _{DS} =-9.6V, V _{GS} =0V, T _J =55°C			-25	
Gate-Body leakage current	I _{GSS}	V _{DS} =0V, V _{GS} =±8V			±100	nA
Gate Threshold Voltage	V _{GS(th)}	V _{DS} =V _{GS} I _D =-250 μA	-0.4	-0.55	-0.95	V
Static Drain-Source On-Resistance	R _{DS(on)}	V _{GS} =-4.5V, I _D =-4.3A			50	mΩ
		V _{GS} =-2.5V, I _D =-2.5A			85	
		V _{GS} =-1.8V, I _D =-2A			125	
Forward Transconductance	g _{FS}	V _{DS} =-10V, I _D =-4.3A	8.6			S
Input Capacitance	C _{iss}	V _{GS} =0V, V _{DS} =-10V, f=1MHz		830		pF
Output Capacitance	C _{oss}			180		
Reverse Transfer Capacitance	C _{rss}			125		
Total Gate Charge	Q _g	V _{GS} =-5.0V, V _{DS} =-10V, I _D =-4.3A		10	15	nC
Gate Source Charge	Q _{gs}			1.4	2.1	
Gate Drain Charge	Q _{gd}			2.6	3.9	
Turn-On DelayTime	t _{d(on)}	I _D =-1.0A, V _{DS} =-6.0V, R _L =6 Ω, R _{GEN} =89 Ω		11		ns
Turn-On Rise Time	t _r			32		
Turn-Off DelayTime	t _{d(off)}			250		
Turn-Off Fall Time	t _f			210		
Body Diode Reverse Recovery Time	t _{rr}	I _F =-1.3A, di/dt=-100A/μs		22	33	
Body Diode Reverse Recovery Charge	Q _{rr}	I _F =-1.3A, di/dt=-100A/μs		8	12	Nc
Maximum Body-Diode Continuous Current	I _S				1.3	A
Diode Forward Voltage	V _{SD}	I _S =-1.3A, V _{GS} =0V			-1.2	V

P-Channel Enhancement MOSFET

■ Typical Characteristics

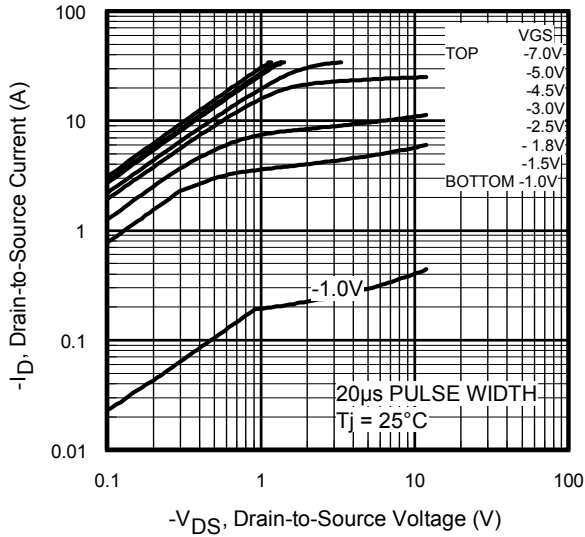

Fig 1. Typical Output Characteristics

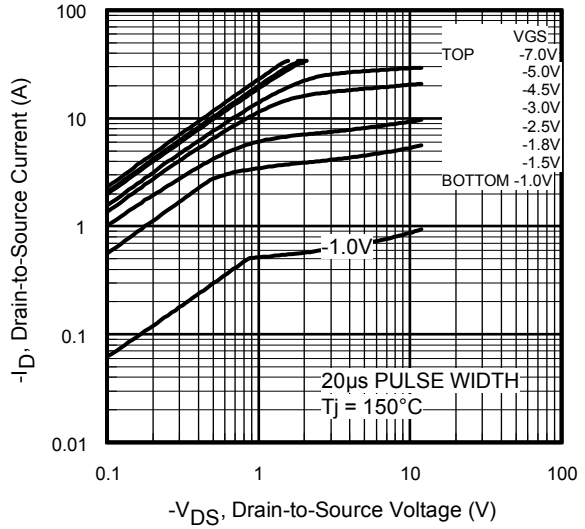

Fig 2. Typical Output Characteristics

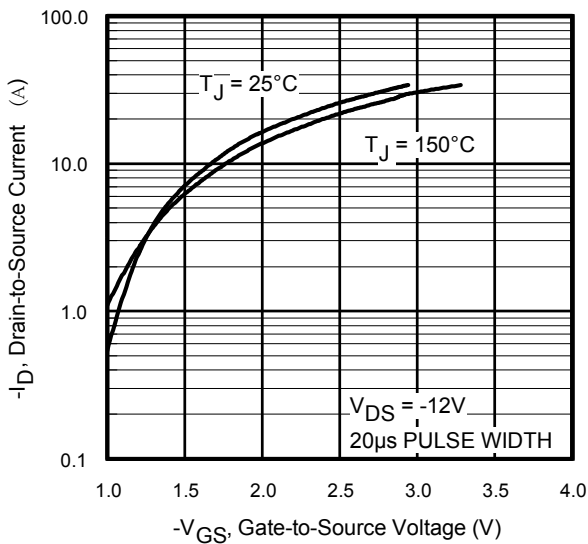

Fig 3. Typical Transfer Characteristics

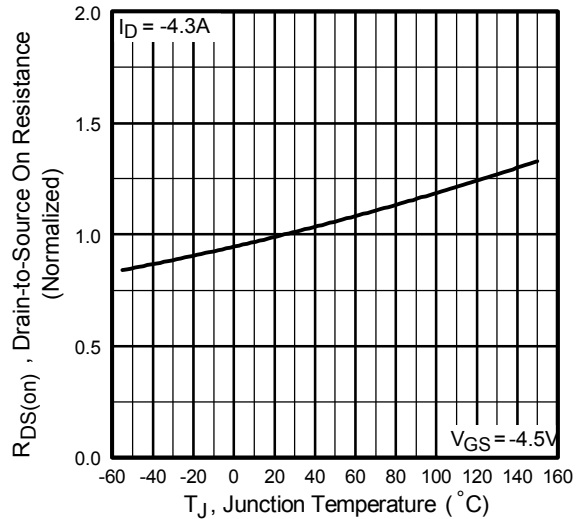

Fig 4. Normalized On-Resistance Vs. Temperature

P-Channel Enhancement MOSFET

■ Typical Characteristics

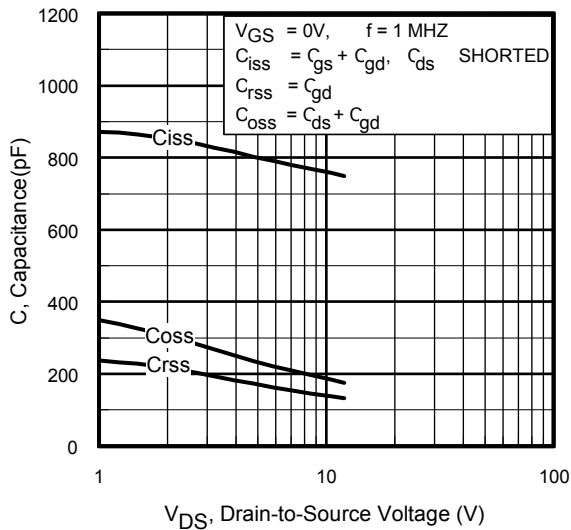

Fig 5. Typical Capacitance Vs. Drain-to-Source Voltage

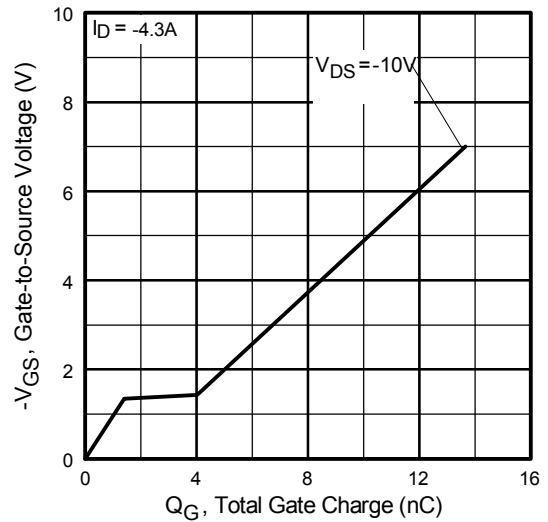

Fig 6. Typical Gate Charge Vs. Gate-to-Source Voltage

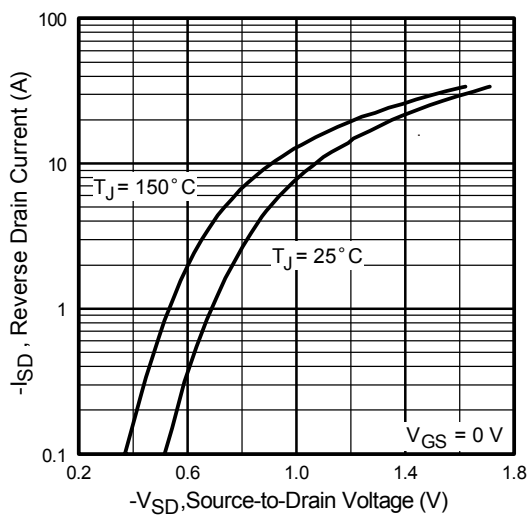

Fig 7. Typical Source-Drain Diode Forward Voltage

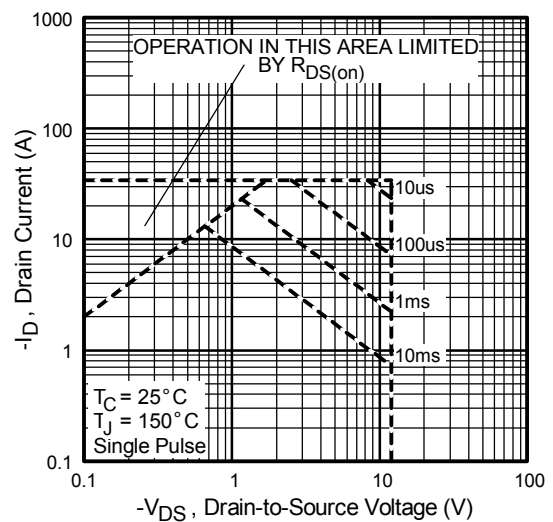

Fig 8. Maximum Safe Operating Area

P-Channel Enhancement MOSFET

■ Typical Characteristics

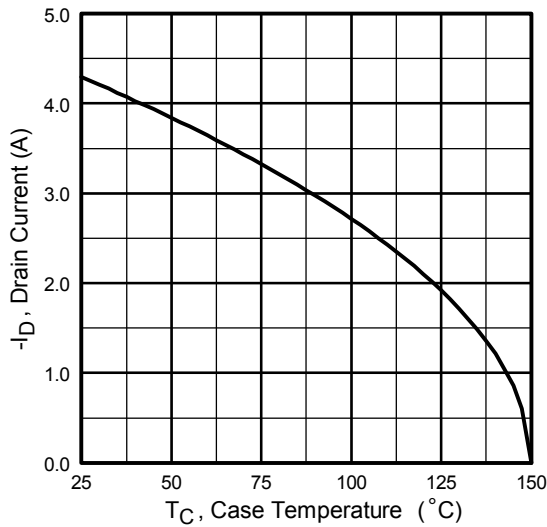

Fig 9. Maximum Drain Current Vs. Case Temperature

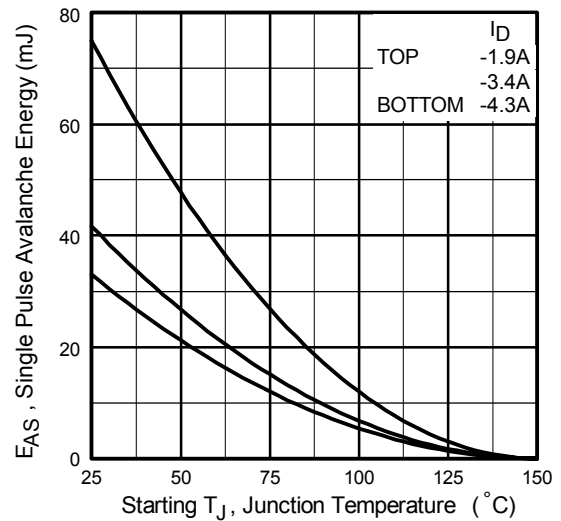

Fig 10. Maximum Avalanche Energy Vs. Drain Current

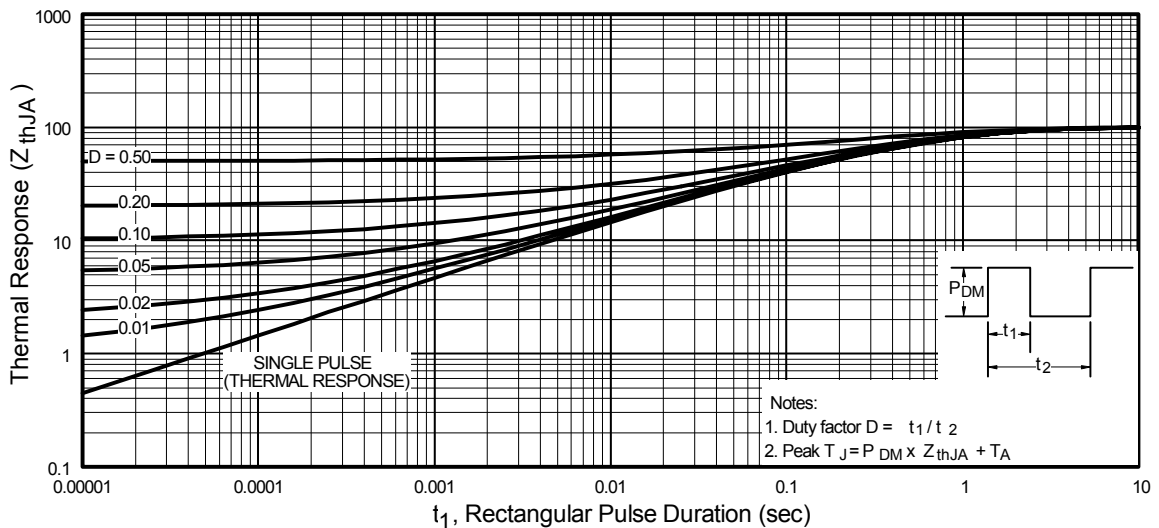

Fig 11. Maximum Effective Transient Thermal Impedance, Junction-to-Ambient

P-Channel Enhancement MOSFET

■ Typical Characteristics

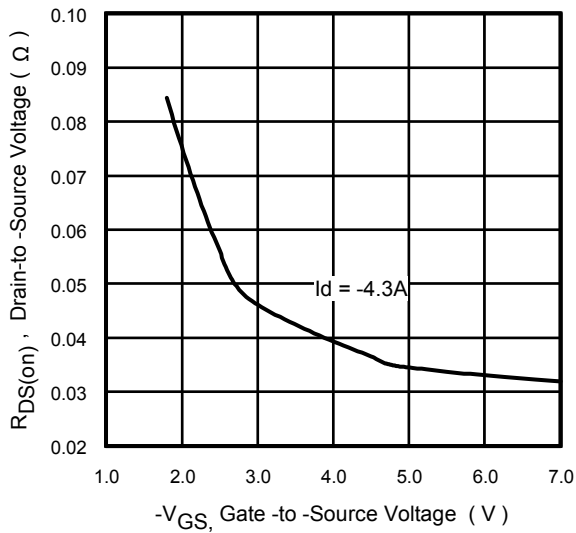

Fig 12. Typical On-Resistance Vs. Gate Voltage

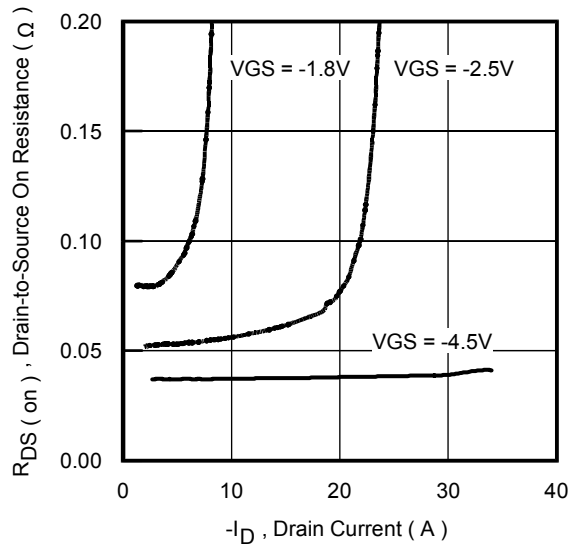

Fig 13. Typical On-Resistance Vs. Drain Current

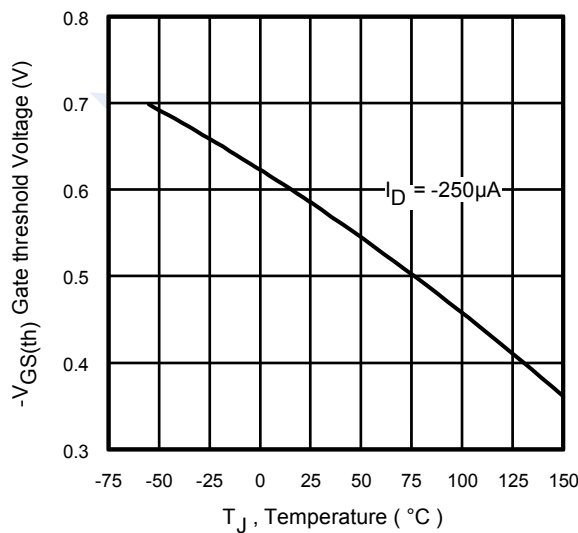

Fig 14. Typical Threshold Voltage Vs. Junction Temperature

单击下面可查看定价，库存，交付和生命周期等信息

[>>UMW\(友台半导体\)](#)