

Description

- Ultra Low On-Resistance
- Fast Switching
- Fully Avalanche Rated
- Lead-Free
- $V_{DS}(V) = 55V$
- $I_D = 27A (V_{GS} = 10V)$
- $R_{DS(ON)} < 45m\Omega (V_{GS} = 10V)$

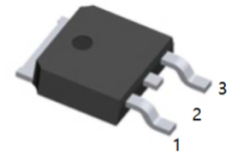

1.G 2.D 3.S
TO-252(DPAK) top view

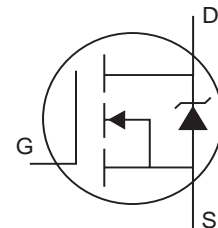

Absolute Maximum Ratings

	Parameter	Max.	Units
$I_D @ T_C = 25^\circ C$	Continuous Drain Current, $V_{GS} @ 10V$	27 [Ⓞ]	A
$I_D @ T_C = 100^\circ C$	Continuous Drain Current, $V_{GS} @ 10V$	19	
I_{DM}	Pulsed Drain Current ^① [Ⓞ]	100	
$P_D @ T_C = 25^\circ C$	Power Dissipation	68	W
	Linear Derating Factor	0.45	W/ [∘] C
V_{GS}	Gate-to-Source Voltage	± 20	V
E_{AS}	Single Pulse Avalanche Energy [Ⓞ] [Ⓞ]	65	mJ
I_{AR}	Avalanche Current ^① [Ⓞ]	16	A
E_{AR}	Repetitive Avalanche Energy ^① [Ⓞ]	6.8	mJ
dv/dt	Peak Diode Recovery dv/dt [Ⓞ]	5.0	V/ns
T_J	Operating Junction and	-55 to + 175	[∘] C
T_{STG}	Storage Temperature Range		
	Soldering Temperature, for 10 seconds	300 (1.6mm from case)	

Thermal Resistance

	Parameter	Typ.	Max.	Units
$R_{\theta JC}$	Junction-to-Case		2.2	[∘] C/W
$R_{\theta JA}$	Junction-to-Ambient (PCB mount) **		50	
$R_{\theta JA}$	Junction-to-Ambient		110	

Electrical Characteristics @ T_J = 25°C (unless otherwise specified)

	Parameter	Min.	Typ.	Max.	Units	Conditions
V _{(BR)DSS}	Drain-to-Source Breakdown Voltage	55			V	V _{GS} = 0V, I _D = 250μA
ΔV _{(BR)DSS} /ΔT _J	Breakdown Voltage Temp. Coefficient		0.052		V/°C	Reference to 25°C, I _D = 1mA
R _{DS(on)}	Static Drain-to-Source On-Resistance		45			V _{GS} = 10V, I _D = 16A ④
V _{GS(th)}	Gate Threshold Voltage	2.0		4.0	V	V _{DS} = V _{GS} , I _D = 250μA
g _{fs}	Forward Transconductance	6.5			S	V _{DS} = 25V, I _D = 16A ⑦
I _{DSS}	Drain-to-Source Leakage Current			25	μA	V _{DS} = 55V, V _{GS} = 0V
				250		V _{DS} = 44V, V _{GS} = 0V, T _J = 150°C
I _{GSS}	Gate-to-Source Forward Leakage			100	nA	V _{GS} = 20V
	Gate-to-Source Reverse Leakage			-100		V _{GS} = -20V
Q _g	Total Gate Charge			34		I _D = 16A
Q _{gs}	Gate-to-Source Charge			6.8	nC	V _{DS} = 44V
Q _{gd}	Gate-to-Drain ("Miller") Charge			14		V _{GS} = 10V, See Fig. 6 and 13 ④ ⑦
t _{d(on)}	Turn-On Delay Time		7.0			V _{DD} = 28V
t _r	Rise Time		49		ns	I _D = 16A R _G = 18Ω R _D = 1.8Ω, See Fig. 10 ④ ⑦
t _{d(off)}	Turn-Off Delay Time		31			
t _f	Fall Time		40			
L _D	Internal Drain Inductance		4.5		nH	Between lead, 6mm (0.25in.) from package and center of die contact ⑥
L _S	Internal Source Inductance		7.5			
C _{iss}	Input Capacitance		700			V _{GS} = 0V
C _{oss}	Output Capacitance		240		pF	V _{DS} = 25V
C _{rss}	Reverse Transfer Capacitance		100			f = 1.0MHz, See Fig. 5 ⑦
	Parameter	Min.	Typ.	Max.	Units	Conditions
I _S	Continuous Source Current (Body Diode)			27 ⑤	A	MOSFET symbol showing the integral reverse p-n junction diode.
I _{SM}	Pulsed Source Current (Body Diode) ① ⑦			100		
V _{SD}	Diode Forward Voltage			1.6	V	T _J = 25°C, I _S = 16A, V _{GS} = 0V ④
t _{rr}	Reverse Recovery Time		57	86	ns	T _J = 25°C, I _F = 16A
Q _{rr}	Reverse Recovery Charge		130	200	nC	di/dt = 100A/μs ④ ⑦
t _{on}	Forward Turn-On Time	Intrinsic turn-on time is negligible (turn-on is dominated by L _S +L _D)				

Notes:

- ① Repetitive rating; pulse width limited by max. junction temperature. (See fig. 11)
- ② V_{DD} = 25V, starting T_J = 25°C, L = 410μH
R_G = 25Ω, I_{AS} = 16A. (See Figure 12)
- ③ I_{SD} ≤ 16A, di/dt ≤ 420A/μs, V_{DD} ≤ V_{(BR)DSS},
T_J ≤ 175°C
- ④ Pulse width ≤ 300μs; duty cycle ≤ 2%
- ⑤ Calculated continuous current based on maximum allowable junction temperature; Package limitation current = 20A

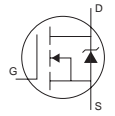
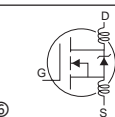

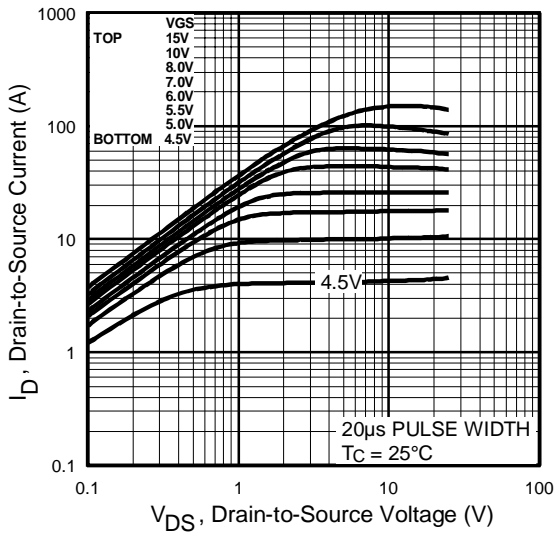

Fig 1. Typical Output Characteristics

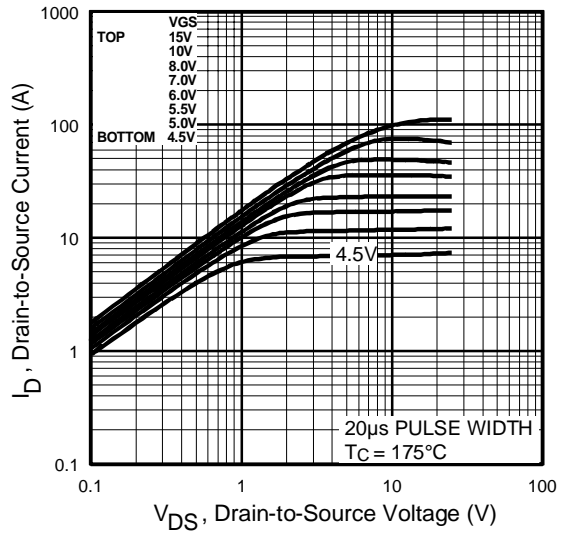

Fig 2. Typical Output Characteristics

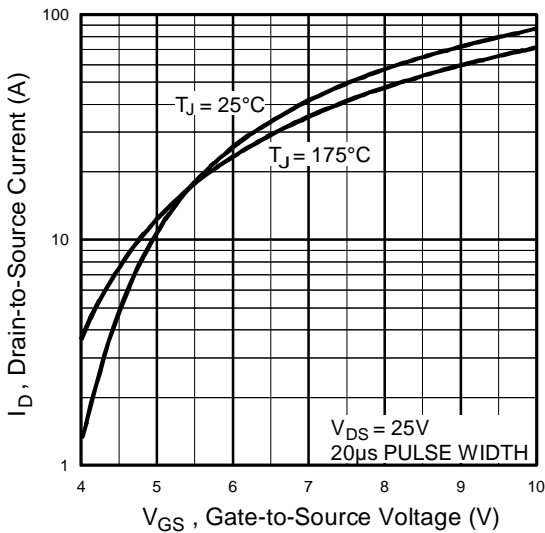

Fig 3. Typical Transfer Characteristics

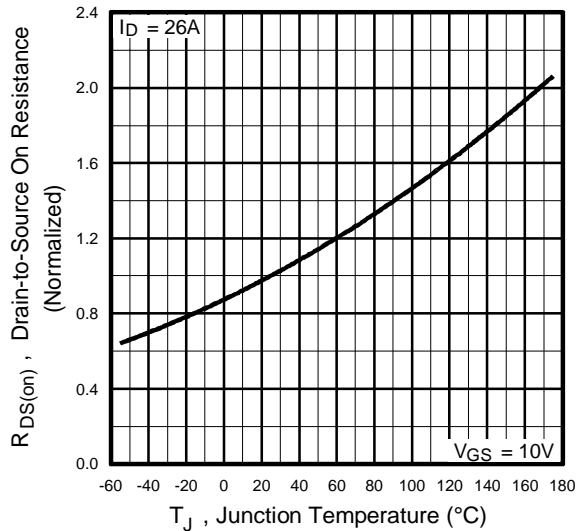

Fig 4. Normalized On-Resistance Vs. Temperature

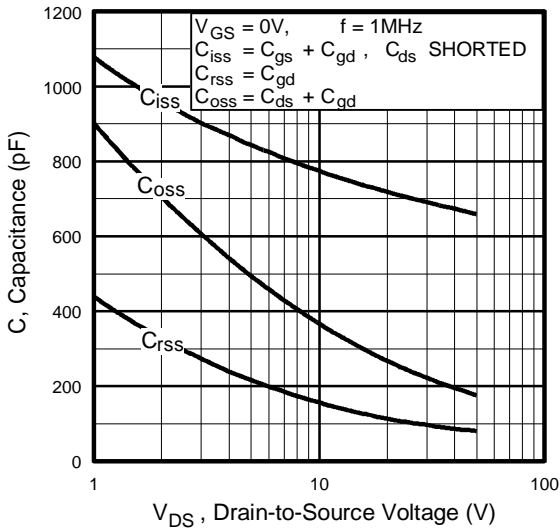

Fig 5. Typical Capacitance Vs. Drain-to-Source Voltage

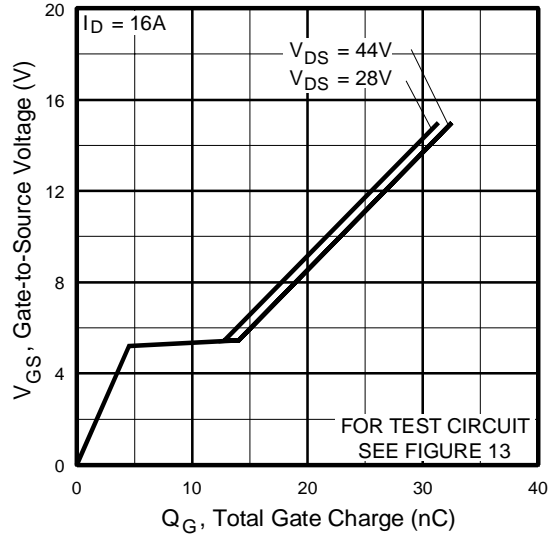

Fig 6. Typical Gate Charge Vs. Gate-to-Source Voltage

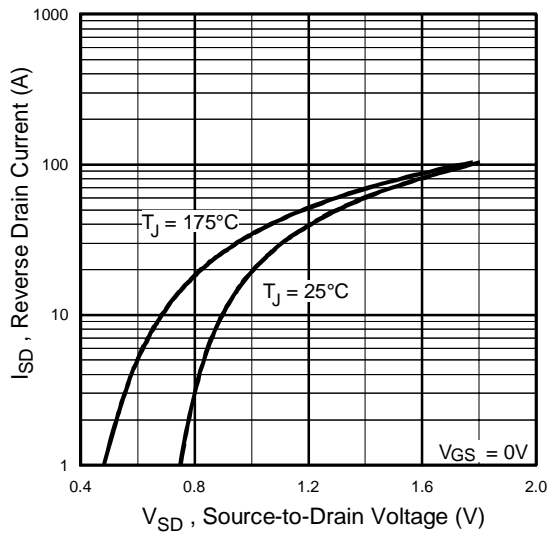

Fig 7. Typical Source-Drain Diode Forward Voltage

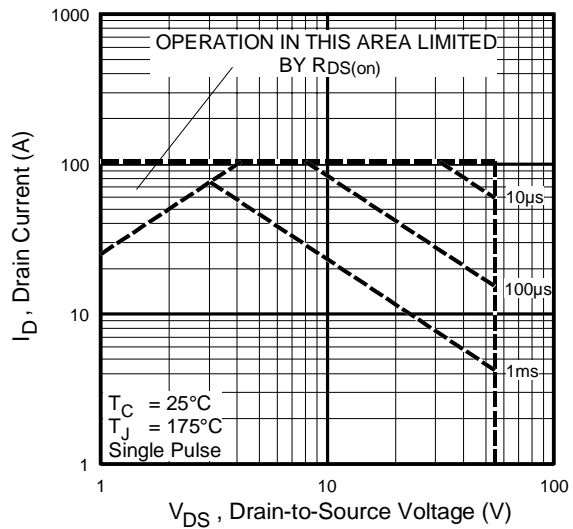

Fig 8. Maximum Safe Operating Area

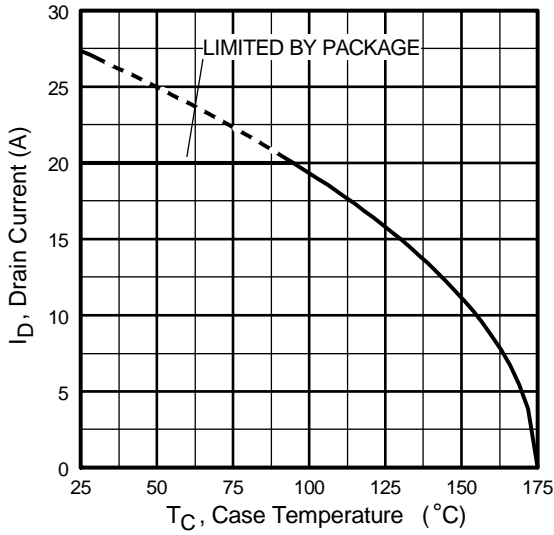

Fig 9. Maximum Drain Current Vs. Case Temperature

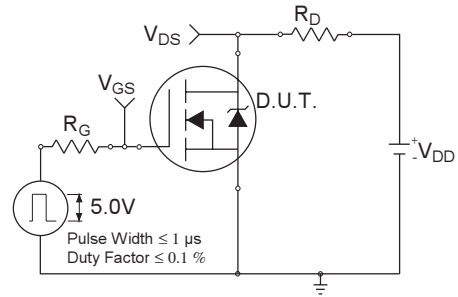

Fig 10a. Switching Time Test Circuit

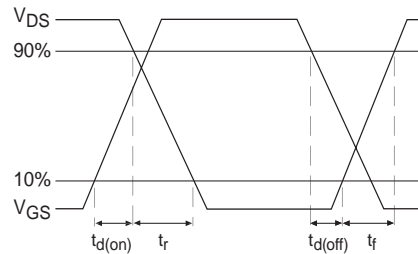

Fig 10b. Switching Time Waveforms

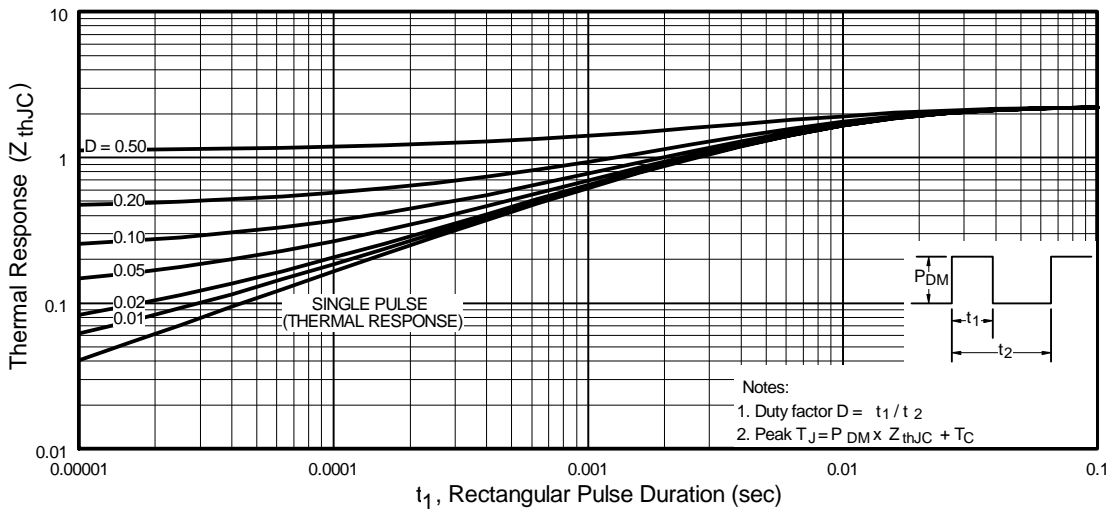

Fig 11. Maximum Effective Transient Thermal Impedance, Junction-to-Case

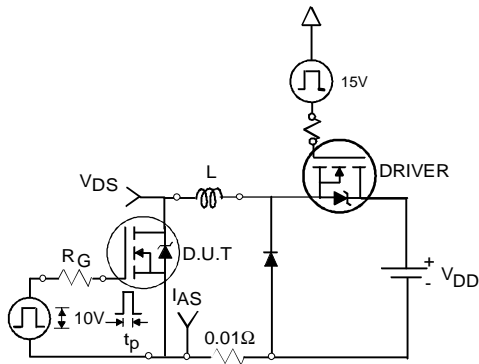

Fig 12a. Unclamped Inductive Test Circuit

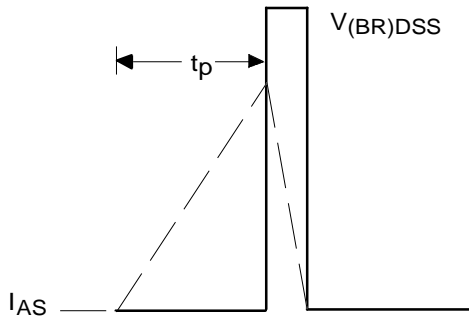

Fig 12b. Unclamped Inductive Waveforms

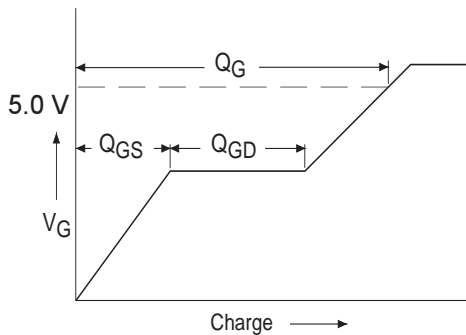

Fig 13a. Basic Gate Charge Waveform

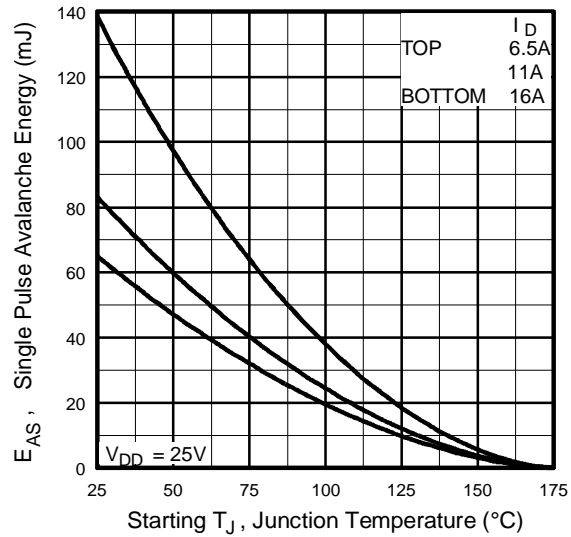

Fig 12c. Maximum Avalanche Energy Vs. Drain Current

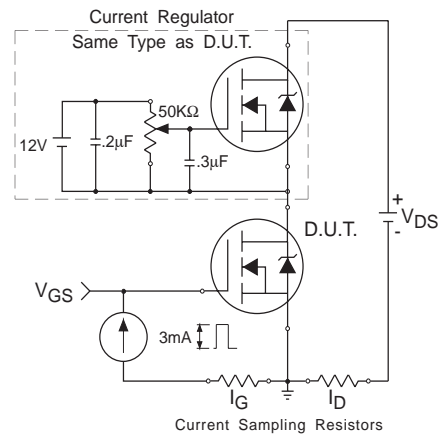
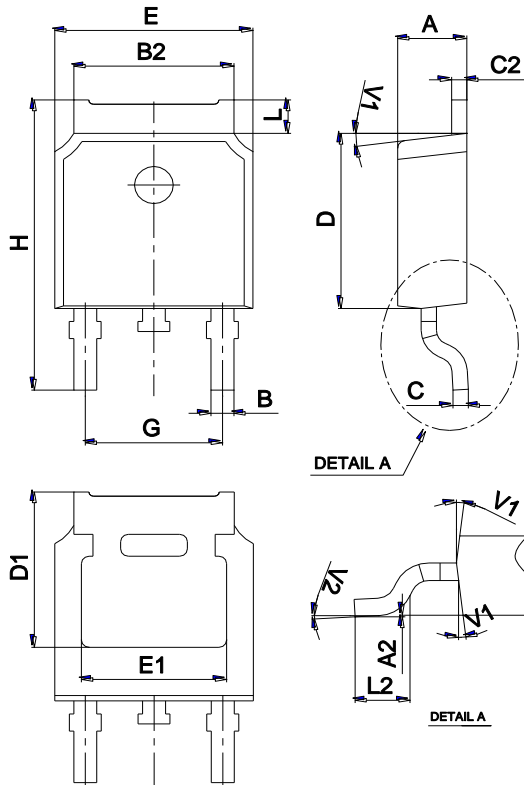

Fig 13b. Gate Charge Test Circuit

Package Mechanical Data TO-252



Ref.	Dimensions					
	Millimeters			Inches		
	Min.	Typ.	Max.	Min.	Typ.	Max.
A	2.10		2.50	0.083		0.098
A2	0		0.10	0		0.004
B	0.66		0.86	0.026		0.034
B2	5.18		5.48	0.202		0.216
C	0.40		0.60	0.016		0.024
C2	0.44		0.58	0.017		0.023
D	5.90		6.30	0.232		0.248
D1	5.30REF			0.209REF		
E	6.40		6.80	0.252		0.268
E1	4.63			0.182		
G	4.47		4.67	0.176		0.184
H	9.50		10.70	0.374		0.421
L	1.09		1.21	0.043		0.048
L2	1.35		1.65	0.053		0.065
V1		7°			7°	
V2	0°		6°	0°		6°

Marking

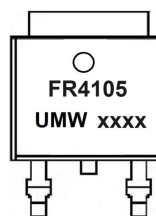

Ordering information

Order code	Package	Baseqty	Deliverymode
UMW IRFR4105TR	TO-252	2500	Tape and reel

单击下面可查看定价，库存，交付和生命周期等信息

[>>UMW\(友台半导体\)](#)