

SOT-23 Plastic-Encapsulate Transistors

MMBT5551 TRANSISTOR (NPN)

FEATURES

- Complementary to MMBT5401
- Ideal for Medium Power Amplification and Switching

MARKING: G1

MAXIMUM RATINGS ($T_a=25^\circ\text{C}$ unless otherwise noted)

Symbol	Parameter	Value	Unit
V_{CBO}	Collector-Base Voltage	180	V
V_{CEO}	Collector-Emitter Voltage	160	V
V_{EBO}	Emitter-Base Voltage	6	V
I_C	Collector Current	600	mA
P_C	Collector Power Dissipation	300	mW
$R_{\theta JA}$	Thermal Resistance From Junction To Ambient	416	$^\circ\text{C}/\text{W}$
T_j	Junction Temperature	150	$^\circ\text{C}$
T_{stg}	Storage Temperature	-55~+150	$^\circ\text{C}$

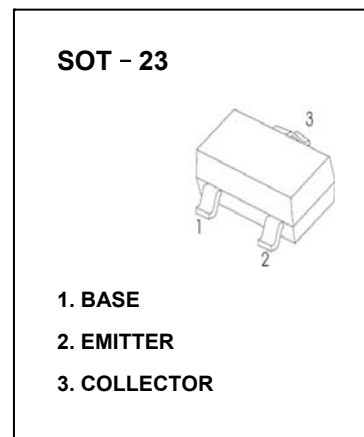

ELECTRICAL CHARACTERISTICS ($T_a=25^\circ\text{C}$ unless otherwise specified)

Parameter	Symbol	Test conditions	Min	Typ	Max	Unit
Collector-base breakdown voltage	$V_{(BR)CBO}$	$I_C=100\mu\text{A}, I_E=0$	180			V
Collector-emitter breakdown voltage	$V_{(BR)CEO}^*$	$I_C=1\text{mA}, I_B=0$	160			V
Emitter-base breakdown voltage	$V_{(BR)EBO}$	$I_E=10\mu\text{A}, I_C=0$	6			V
Collector cut-off current	I_{CBO}	$V_{CB}=120\text{V}, I_E=0$			50	nA
Emitter cut-off current	I_{EBO}	$V_{EB}=4\text{V}, I_C=0$			50	nA
DC current gain	$h_{FE(1)}^*$	$V_{CE}=5\text{V}, I_C=1\text{mA}$	80			
	$h_{FE(2)}^*$	$V_{CE}=5\text{V}, I_C=10\text{mA}$	100		300	
	$h_{FE(3)}^*$	$V_{CE}=5\text{V}, I_C=50\text{mA}$	50			
Collector-emitter saturation voltage	$V_{CE(sat)1}^*$	$I_C=10\text{mA}, I_B=1\text{mA}$			0.15	V
	$V_{CE(sat)2}^*$	$I_C=50\text{mA}, I_B=5\text{mA}$			0.2	V
Base-emitter saturation voltage	$V_{BE(sat)1}^*$	$I_C=10\text{mA}, I_B=1\text{mA}$			1	V
	$V_{BE(sat)2}^*$	$I_C=50\text{mA}, I_B=5\text{mA}$			1	V
Transition frequency	f_T	$V_{CE}=10\text{V}, I_C=10\text{mA}, f=100\text{MHz}$	100		300	MHz
Collector output capacitance	C_{ob}	$V_{CB}=10\text{V}, I_E=0, f=1\text{MHz}$			6	pF

*Pulse test: pulse width $\leq 300\mu\text{s}$, duty cycles $\leq 2.0\%$.

CLASSIFICATION OF $h_{FE(2)}$

RANK	L	H
RANGE	100-200	200-300

SOT-23 Plastic-Encapsulate Transistors

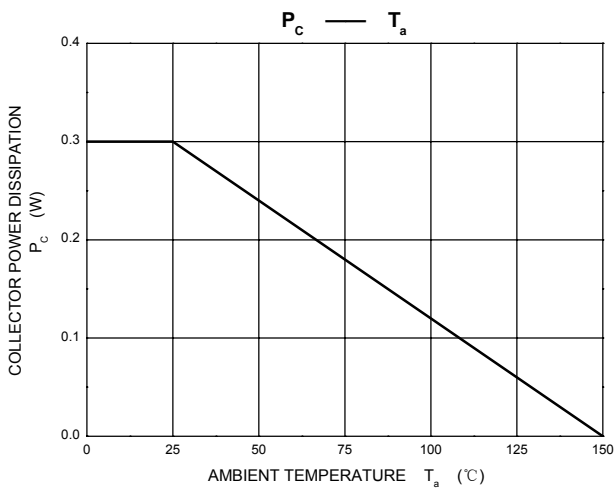
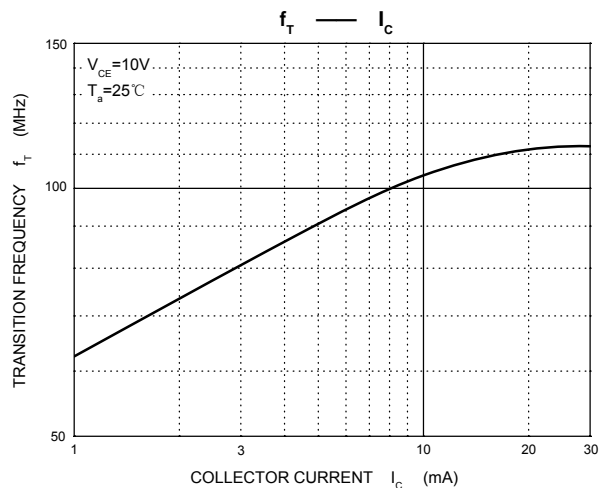
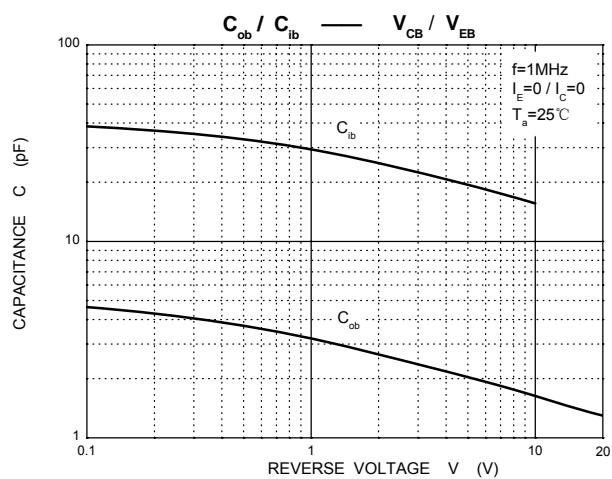
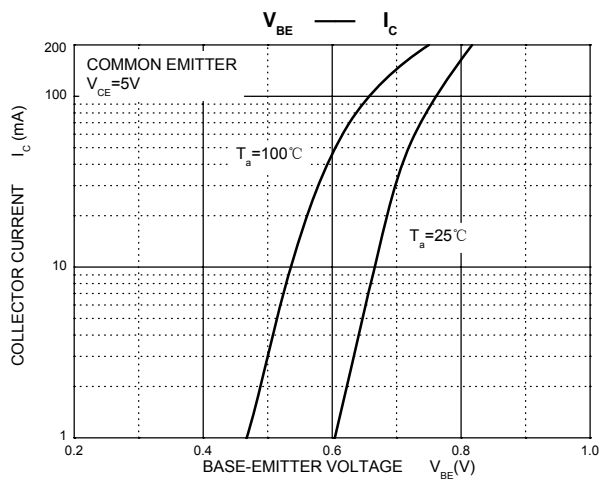
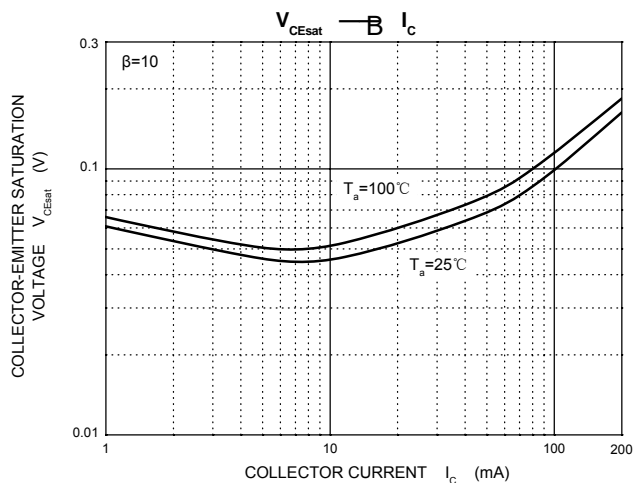
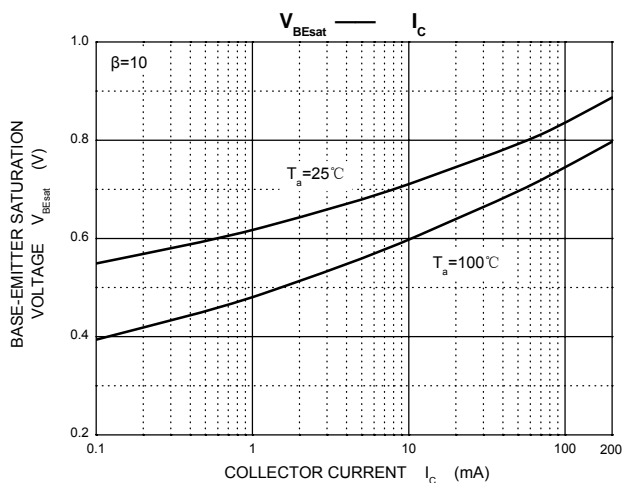
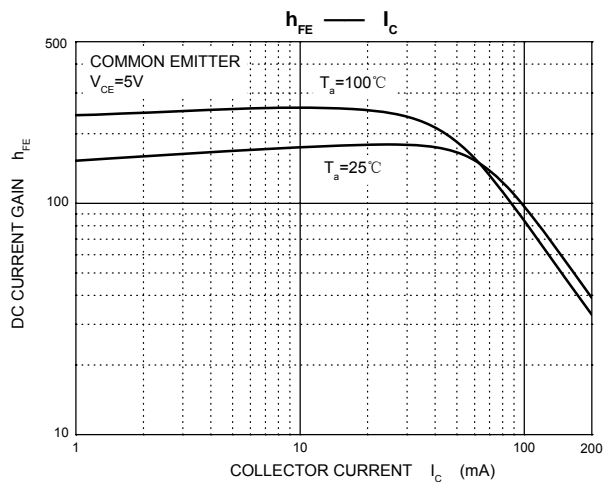
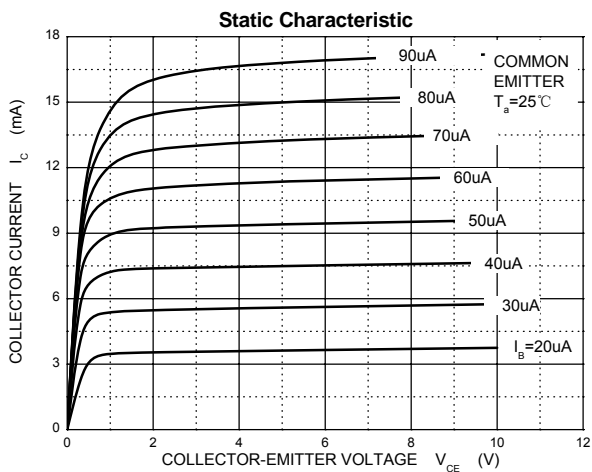

单击下面可查看定价，库存，交付和生命周期等信息

[>>UMW\(友台半导体\)](#)