

Applications

- High Frequency DC-DC Converters with Synchronous Rectification
- Lead-Free

Benefits

- Ultra-Low $R_{DS(on)}$ at 4.5V V_{GS}
- Low Charge and Low Gate Impedance to Reduce Switching Losses
- Fully Characterized Avalanche Voltage and Current

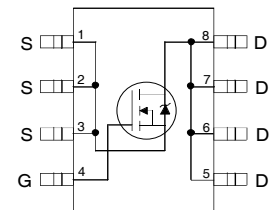

Top View

Features

- $V_{DS(V)} = 30V$
- $I_D = 16 A (V_{GS} = 10V)$
- $R_{DS(ON)} < 6.5m\Omega (V_{GS}=10V)$
- $R_{DS(ON)} < 7.5 m\Omega (V_{GS}=4.5V)$

Absolute Maximum Ratings

Symbol	Parameter	Max.	Units
V_{DS}	Drain-Source Voltage	30	V
V_{GS}	Gate-to-Source Voltage	± 12	V
$I_D @ T_A = 25^\circ C$	Continuous Drain Current, $V_{GS} @ 10V$	16	A
$I_D @ T_A = 70^\circ C$	Continuous Drain Current, $V_{GS} @ 10V$	13	
I_{DM}	Pulsed Drain Current ^①	130	
$P_D @ T_A = 25^\circ C$	Maximum Power Dissipation ^③	2.5	W
$P_D @ T_A = 70^\circ C$	Maximum Power Dissipation ^③	1.6	W
	Linear Derating Factor	0.02	W/ $^\circ C$
T_J, T_{STG}	Junction and Storage Temperature Range	-55 to + 150	$^\circ C$

Thermal Resistance

	Parameter	Max.	Units
$R_{\theta JA}$	Maximum Junction-to-Ambient ^④	50	$^\circ C/W$

Static @ T_J = 25°C (unless otherwise specified)

	Parameter	Min.	Typ.	Max.	Units	Conditions
V _{(BR)DSS}	Drain-to-Source Breakdown Voltage	30			V	V _{GS} = 0V, I _D = 250μA
ΔV _{(BR)DSS} /ΔT _J	Breakdown Voltage Temp. Coefficient		0.024		V/°C	Reference to 25°C, I _D = 1mA
R _{DS(on)}	Static Drain-to-Source On-Resistance		4.7	6.5	mΩ	V _{GS} = 10V, I _D = 16A ③
			5.7	7.5		V _{GS} = 4.5V, I _D = 13A ③
			11	20		V _{GS} = 2.8V, I _D = 3.5A ③
V _{GS(th)}	Gate Threshold Voltage	0.6		2.0	V	V _{DS} = V _{GS} , I _D = 250μA
I _{DSS}	Drain-to-Source Leakage Current			20	μA	V _{DS} = 16V, V _{GS} = 0V
				100		V _{DS} = 16V, V _{GS} = 0V, T _J = 125°C
I _{GSS}	Gate-to-Source Forward Leakage			200	nA	V _{GS} = 12V
	Gate-to-Source Reverse Leakage			-200		V _{GS} = -12V

Dynamic @ T_J = 25°C (unless otherwise specified)

	Parameter	Min.	Typ.	Max.	Units	Conditions
g _{fs}	Forward Transconductance	44			S	V _{DS} = 10V, I _D = 16A
Q _g	Total Gate Charge		41	62	nC	I _D = 16A
Q _{gs}	Gate-to-Source Charge		9.7	15		V _{DS} = 16V
Q _{gd}	Gate-to-Drain ("Miller") Charge		18	27		V _{GS} = 5.0V, ③
t _{d(on)}	Turn-On Delay Time		20			V _{DD} = 10V
t _r	Rise Time		25		ns	I _D = 1.0A
t _{d(off)}	Turn-Off Delay Time		50			R _G = 6.0Ω
t _f	Fall Time		52			V _{GS} = 4.5V ③
C _{iss}	Input Capacitance		3640		pF	V _{GS} = 0V
C _{oss}	Output Capacitance		1570			V _{DS} = 15V
C _{rss}	Reverse Transfer Capacitance		330			f = 1.0MHz

Avalanche Characteristics

	Parameter	Typ.	Max.	Units
E _{AS}	Single Pulse Avalanche Energy②		250	mJ
I _{AR}	Avalanche Current①		16	A
E _{AR}	Repetitive Avalanche Energy①		0.25	mJ

Diode Characteristics

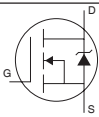
	Parameter	Min.	Typ.	Max.	Units	Conditions
I _S	Continuous Source Current (Body Diode)			2.5	A	MOSFET symbol showing the integral reverse p-n junction diode. 
I _{SM}	Pulsed Source Current (Body Diode) ①			130		
V _{SD}	Diode Forward Voltage			1.2	V	T _J = 25°C, I _S = 2.5A, V _{GS} = 0V ③
t _{rr}	Reverse Recovery Time		48	72	ns	T _J = 25°C, I _F = 2.5A
Q _{rr}	Reverse Recovery Charge		74	110	nC	di/dt = 100A/μs ③

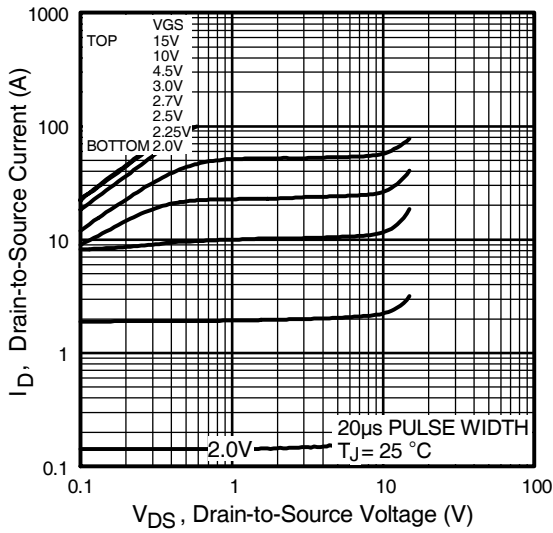

Fig 1. Typical Output Characteristics

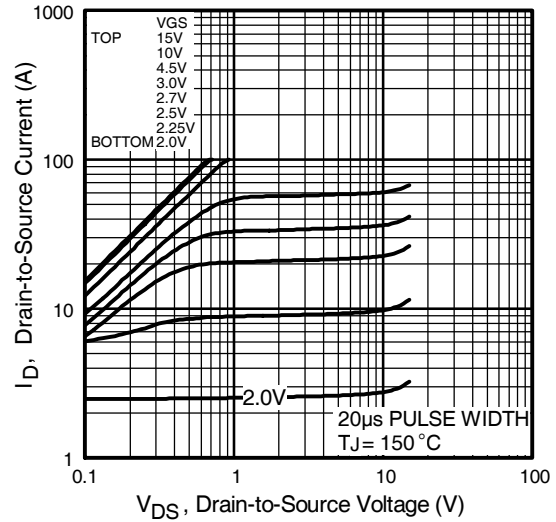

Fig 2. Typical Output Characteristics

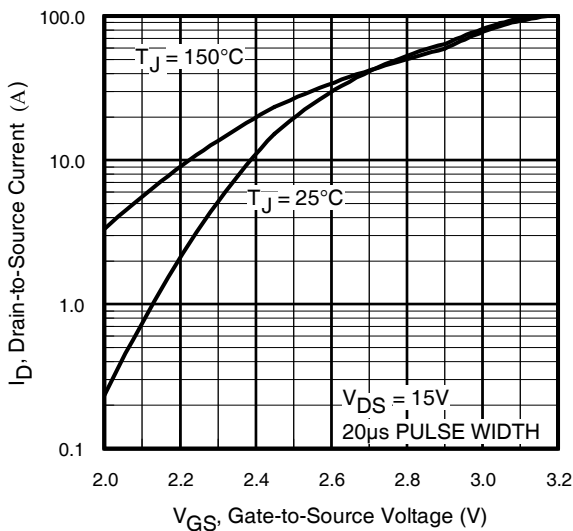

Fig 3. Typical Transfer Characteristics

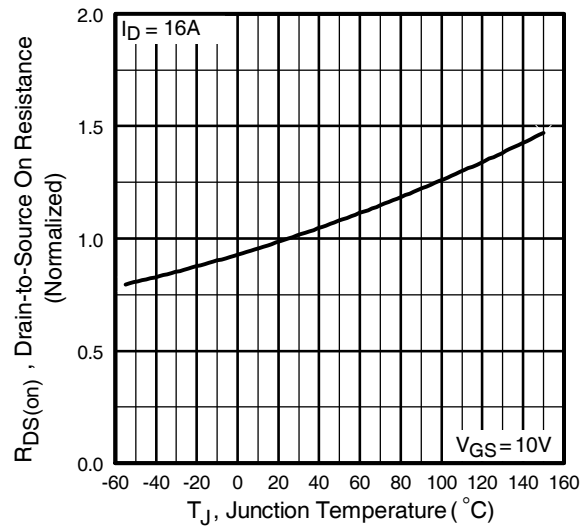

Fig 4. Normalized On-Resistance Vs. Temperature

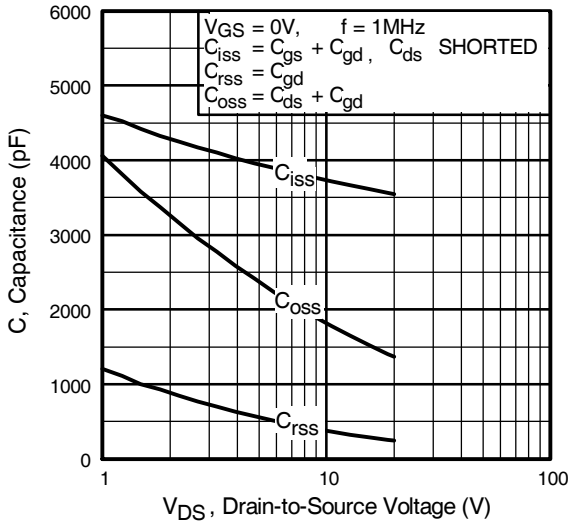

Fig 5. Typical Capacitance Vs. Drain-to-Source Voltage

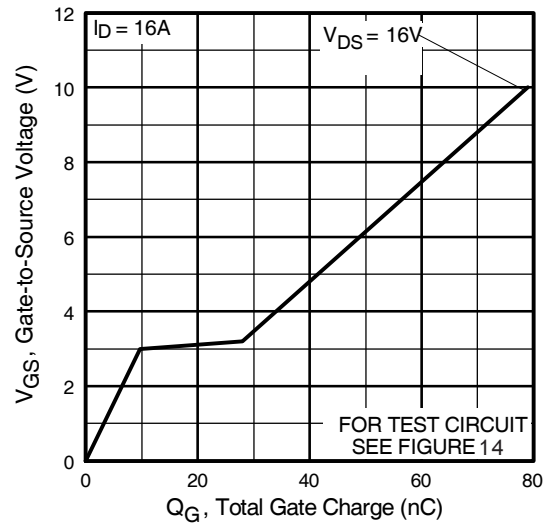

Fig 6. Typical Gate Charge Vs. Gate-to-Source Voltage

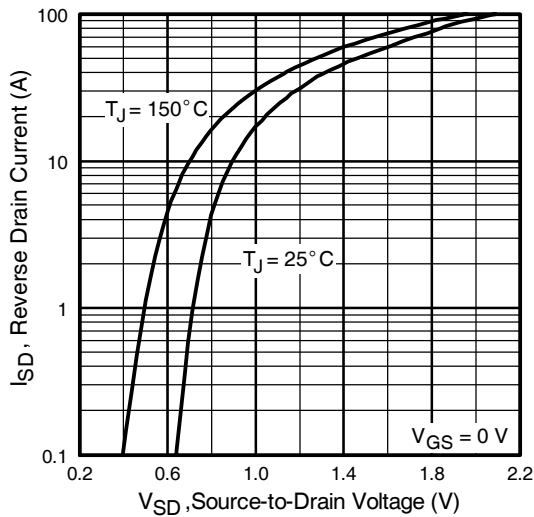

Fig 7. Typical Source-Drain Diode Forward Voltage

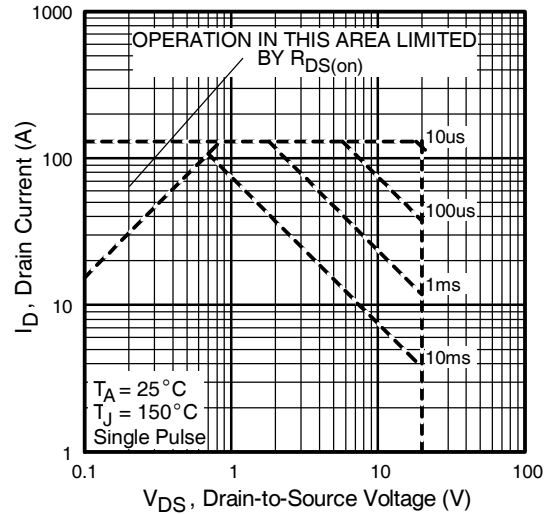

Fig 8. Maximum Safe Operating Area

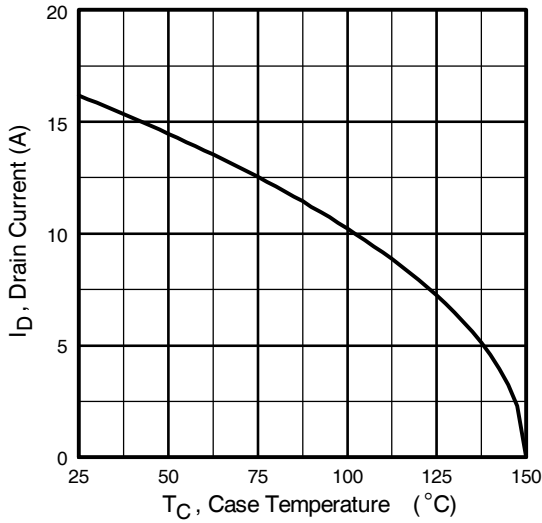

Fig 9. Maximum Drain Current Vs. Case Temperature

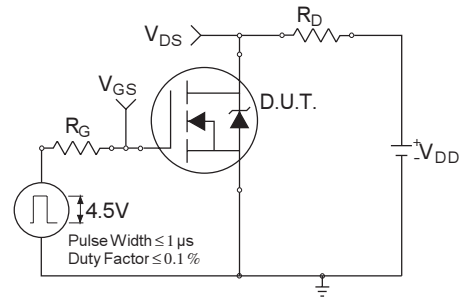

Fig 10a. Switching Time Test Circuit

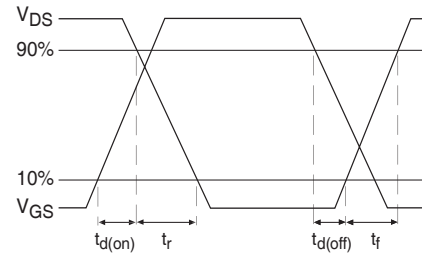

Fig 10b. Switching Time Waveforms

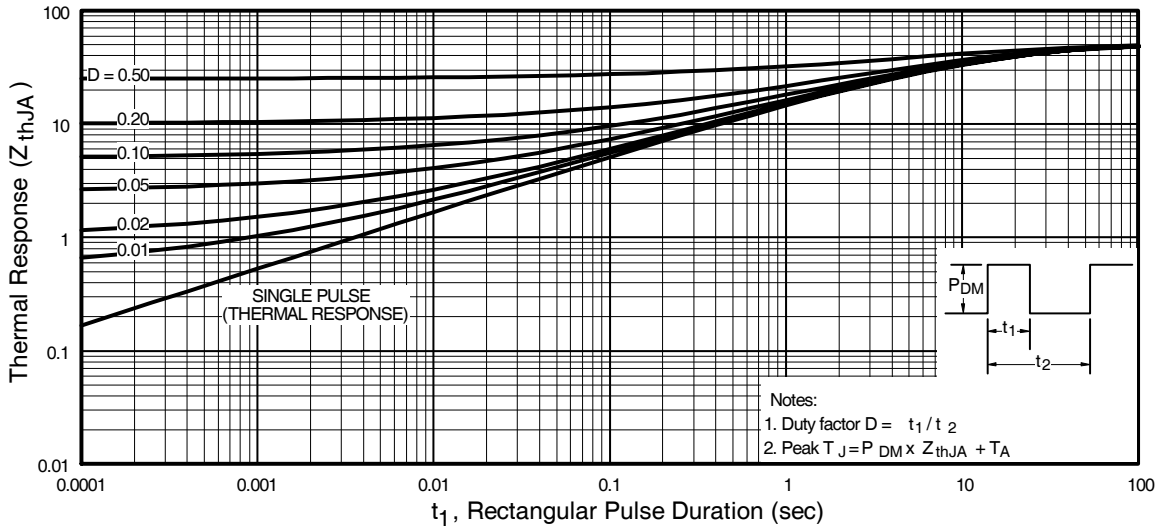

Fig 11. Maximum Effective Transient Thermal Impedance, Junction-to-Case

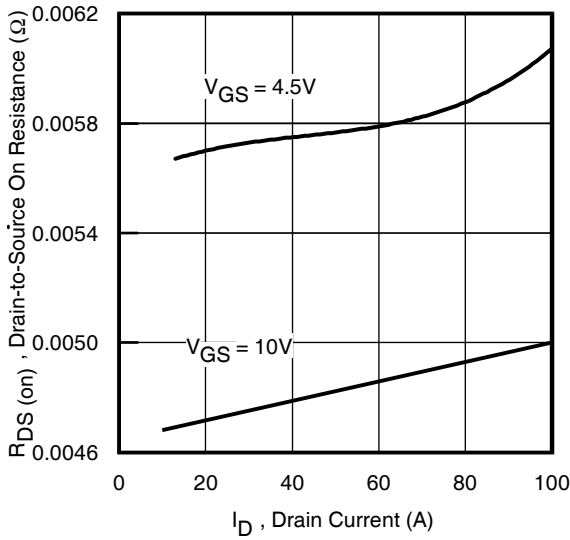

Fig 12. On-Resistance Vs. Drain Current

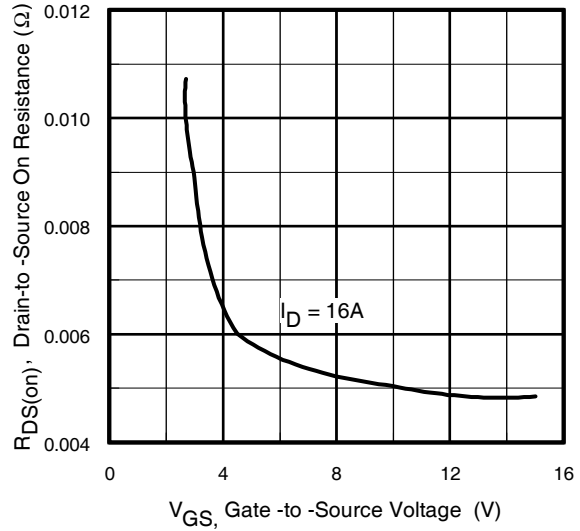

Fig 13. On-Resistance Vs. Gate Voltage

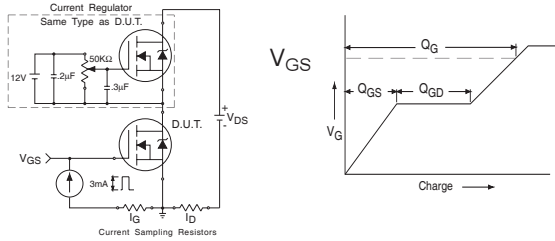

Fig 14a&b. Basic Gate Charge Test Circuit and Waveform

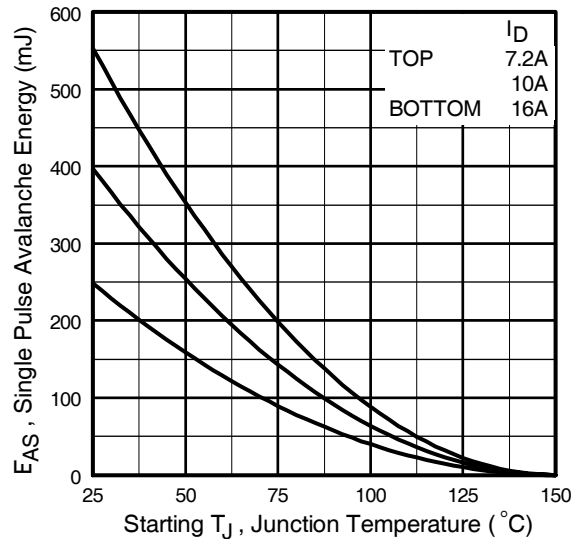

Fig 15c. Maximum Avalanche Energy Vs. Drain Current

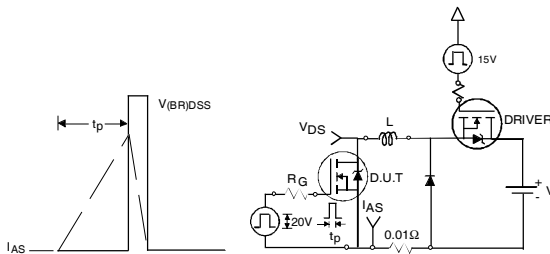
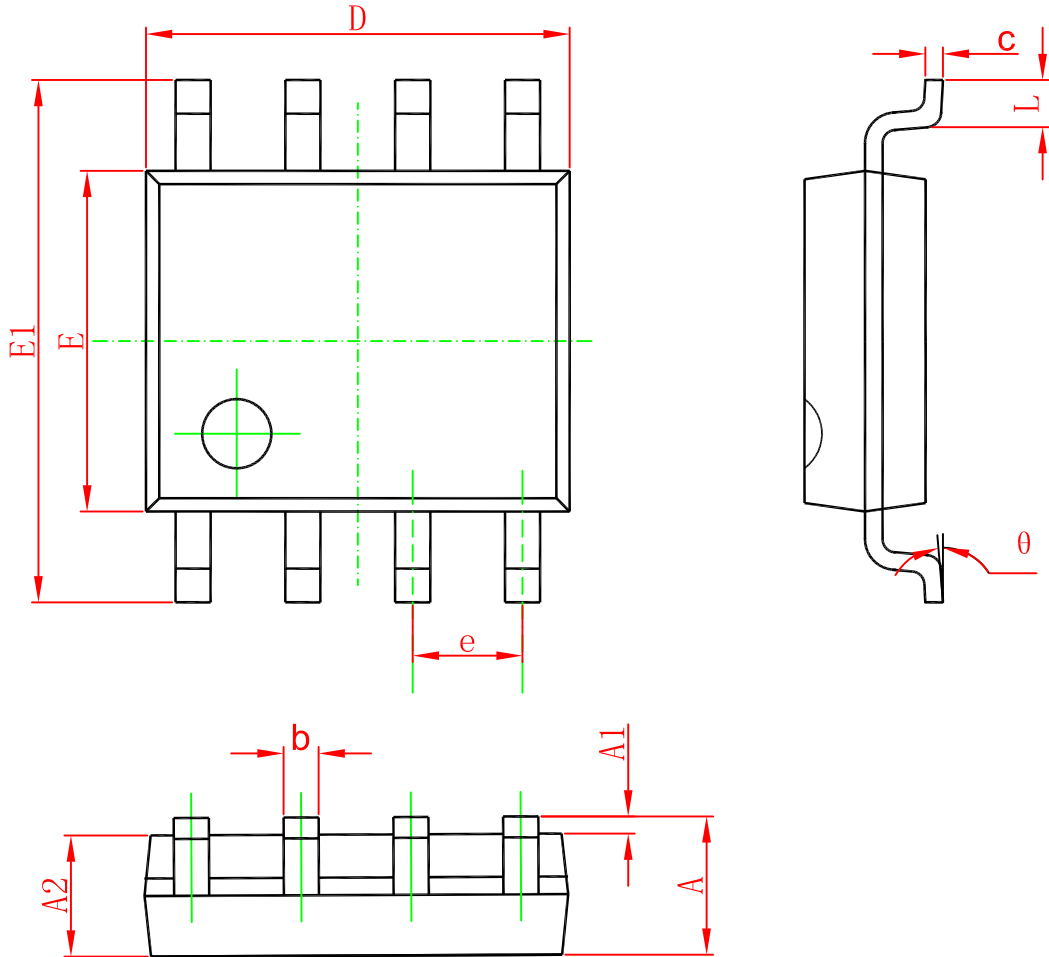

Fig 15a&b. Unclamped Inductive Test circuit and Waveforms

Package Mechanical Data SOP-8



Symbol	Dimensions In Millimeters		Dimensions In Inches	
	Min	Max	Min	Max
A	1.350	1.750	0.053	0.069
A1	0.100	0.250	0.004	0.010
A2	1.350	1.550	0.053	0.061
b	0.330	0.510	0.013	0.020
c	0.170	0.250	0.006	0.010
D	4.700	5.100	0.185	0.200
E	3.800	4.000	0.150	0.157
E1	5.800	6.200	0.228	0.244
e	1.270(BSC)		0.050(BSC)	
L	0.400	1.270	0.016	0.050
θ	0°	8°	0°	8°

Marking

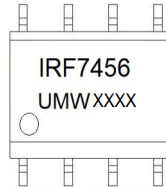

Ordering information

Order code	Package	Baseqty	Deliverymode
UMWIRF7456TR	SOP-8	3000	Tape and reel

单击下面可查看定价，库存，交付和生命周期等信息

[>>UMW\(友台半导体\)](#)