

### Features

- Ultra-Low  $R_{DS(on)}$ , Single Base, Advanced Technology
- SPICE Parameters Available
- Diode is Characterized for use in Bridge Circuits
- $I_{DSS}$  and  $V_{(on)}$  Specified at Elevated Temperatures
- High Avalanche Energy Specified

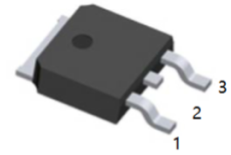

1.G 2.D 3.S  
TO-252(DPAK) top view

### Typical Applications

- Power Supplies
- Inductive Loads
- PWM Motor Controls
  
- $V_{DS}$  (V) = 30V
- $R_{DS(ON)} < 27m\Omega$  ( $V_{GS} = 5V$ )

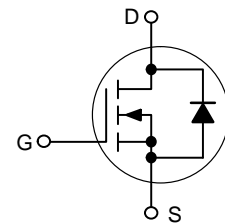

### MAXIMUM RATINGS( $T_C = 25^\circ C$ unless otherwise noted)

Rating	Symbol	Value	Unit
Drain-to-Source Voltage	$V_{DSS}$	30	Vdc
Drain-to-Gate Voltage ( $R_{GS} = 1.0 M\Omega$ )	$V_{DGR}$	30	Vdc
Gate-to-Source Voltage	$V_{GS}$ $V_{GS}$	$\pm 20$	Vdc
- Continuous		$\pm 24$	
- Non-Repetitive ( $t_p \leq 10$ ms)			
Drain Current	$I_D$ $I_D$ $I_{DM}$	20	A dc
- Continuous @ $T_A = 25^\circ C$		16	
- Continuous @ $T_A = 100^\circ C$		60	A pk
- Single Pulse ( $t_p \leq 10 \mu s$ )			
Total Power Dissipation @ $T_A = 25^\circ C$	$P_D$	74	W
Derate above $25^\circ C$		0.6	
Total Power Dissipation @ $T_C = 25^\circ C$ (Note 1)		1.75	
Operating and Storage Temperature Range	$T_J, T_{stg}$	-55 to 150	$^\circ C$
Single Pulse Drain-to-Source Avalanche Energy - Starting $T_J = 25^\circ C$ ( $V_{DD} = 30$ Vdc, $V_{GS} = 5$ Vdc, $L = 1.0$ mH, $I_{L(pk)} = 24$ A, $V_{DS} = 34$ Vdc)	$E_{AS}$	288	mJ
Thermal Resistance	$R_{\theta JC}$ $R_{\theta JA}$ $R_{\theta JA}$	1.67	$^\circ C/W$
- Junction-to-Case		100	
- Junction-to-Ambient (Note 1)		71.4	
Maximum Lead Temperature for Soldering Purposes, 1/8" from case for 10 seconds	$T_L$	260	$^\circ C$

Stresses exceeding those listed in the Maximum Ratings table may damage the device. If any of these limits are exceeded, device functionality should not be assumed, damage may occur and reliability may be affected.

1. When surface mounted to an FR4 board using the minimum recommended pad size and repetitive rating; pulse width limited by maximum junction temperature.

**ELECTRICAL CHARACTERISTICS** ( $T_C = 25^\circ\text{C}$  unless otherwise noted)

Characteristic	Symbol	Min	Typ	Max	Unit
<b>OFF CHARACTERISTICS</b>					
Drain-to-Source Breakdown Voltage (Note 2) ( $V_{GS} = 0\text{ Vdc}$ , $I_D = 250\ \mu\text{Adc}$ ) Temperature Coefficient (Positive)	$V_{(BR)DSS}$	30	43		Vdc mV/°C
Zero Gate Voltage Drain Current ( $V_{DS} = 30\text{ Vdc}$ , $V_{GS} = 0\text{ Vdc}$ ) ( $V_{DS} = 30\text{ Vdc}$ , $V_{GS} = 0\text{ Vdc}$ , $T_J = 150^\circ\text{C}$ )	$I_{DSS}$			10 100	$\mu\text{Adc}$
Gate-Body Leakage Current ( $V_{GS} = \pm 20\text{ Vdc}$ , $V_{DS} = 0\text{ Vdc}$ )	$I_{GSS}$			$\pm 100$	nAdc

**ON CHARACTERISTICS** (Note 2)

Gate Threshold Voltage (Note 2) ( $V_{DS} = V_{GS}$ , $I_D = 250\ \mu\text{Adc}$ ) Threshold Temperature Coefficient (Negative)	$V_{GS(th)}$	1.0	1.7 5.0	2.5	Vdc mV/°C
Static Drain-to-Source On-Resistance (Note 2) ( $V_{GS} = 4.0\text{ Vdc}$ , $I_D = 10\text{ Adc}$ ) ( $V_{GS} = 5.0\text{ Vdc}$ , $I_D = 10\text{ Adc}$ )	$R_{DS(on)}$		28 23	31 27	m $\Omega$
Static Drain-to-Source On-Voltage (Note 2) ( $V_{GS} = 5.0\text{ Vdc}$ , $I_D = 20\text{ Adc}$ ) ( $V_{GS} = 5.0\text{ Vdc}$ , $I_D = 10\text{ Adc}$ , $T_J = 150^\circ\text{C}$ )	$V_{DS(on)}$		0.48 0.40	0.54	Vdc
Forward Transconductance (Note 2) ( $V_{DS} = 5.0\text{ Vdc}$ , $I_D = 10\text{ Adc}$ )	$g_{FS}$		21		mhos

**DYNAMIC CHARACTERISTICS**

Input Capacitance	$(V_{DS} = 25\text{ Vdc}$ , $V_{GS} = 0\text{ Vdc}$ , $f = 1.0\text{ MHz}$ )	$C_{iss}$	1005	1260	pF
Output Capacitance		$C_{oss}$	271	420	
Transfer Capacitance		$C_{rss}$	87	112	

**SWITCHING CHARACTERISTICS** (Note 3)

Turn-On Delay Time	$(V_{DD} = 20\text{ Vdc}$ , $I_D = 20\text{ Adc}$ , $V_{GS} = 5.0\text{ Vdc}$ , $R_G = 9.1\ \Omega$ ) (Note 2)	$t_{d(on)}$	17	25	ns
Rise Time		$t_r$	137	160	
Turn-Off Delay Time		$t_{d(off)}$	38	45	
Fall Time		$t_f$	31	40	
Gate Charge	$(V_{DS} = 48\text{ Vdc}$ , $I_D = 15\text{ Adc}$ , $V_{GS} = 10\text{ Vdc}$ ) (Note 2)	$Q_T$	13.8	18.9	nC
		$Q_1$	2.8		
		$Q_2$	6.6		

**SOURCE-DRAIN DIODE CHARACTERISTICS**

Forward On-Voltage	$(I_S = 20\text{ Adc}$ , $V_{GS} = 0\text{ Vdc}$ ) (Note 2) $(I_S = 20\text{ Adc}$ , $V_{GS} = 0\text{ Vdc}$ , $T_J = 125^\circ\text{C}$ )	$V_{SD}$	1.0 0.9	1.15	Vdc
Reverse Recovery Time		$(I_S = 15\text{ Adc}$ , $V_{GS} = 0\text{ Vdc}$ , $di/dt = 100\text{ A}/\mu\text{s}$ ) (Note 2)	$t_{rr}$	23	
	$t_a$		13		
	$t_b$		10		
Reverse Recovery Stored Charge		$Q_{RR}$	0.017		$\mu\text{C}$

Product parametric performance is indicated in the Electrical Characteristics for the listed test conditions, unless otherwise noted. Product performance may not be indicated by the Electrical Characteristics if operated under different conditions.

2. Pulse Test: Pulse Width  $\leq 300\ \mu\text{s}$ , Duty Cycle  $\leq 2\%$ .

3. Switching characteristics are independent of operating junction temperature.

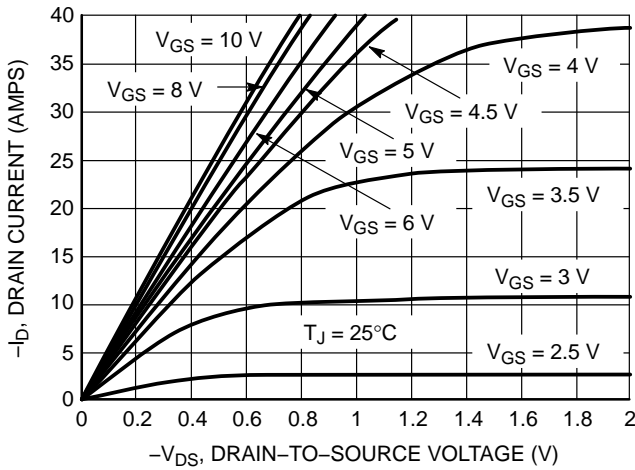

Figure 1. On-Region Characteristics

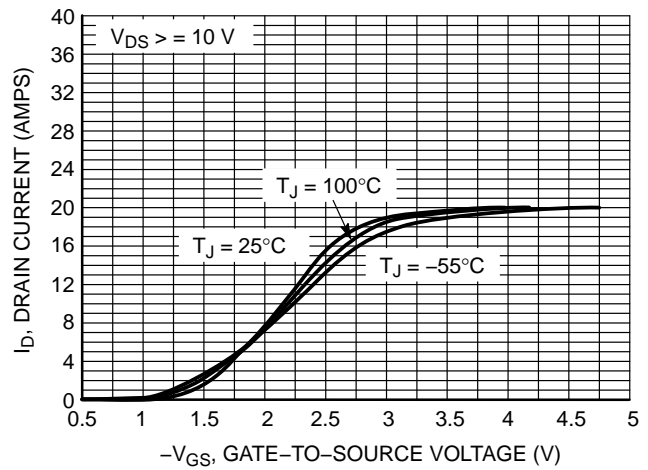

Figure 2. Transfer Characteristics

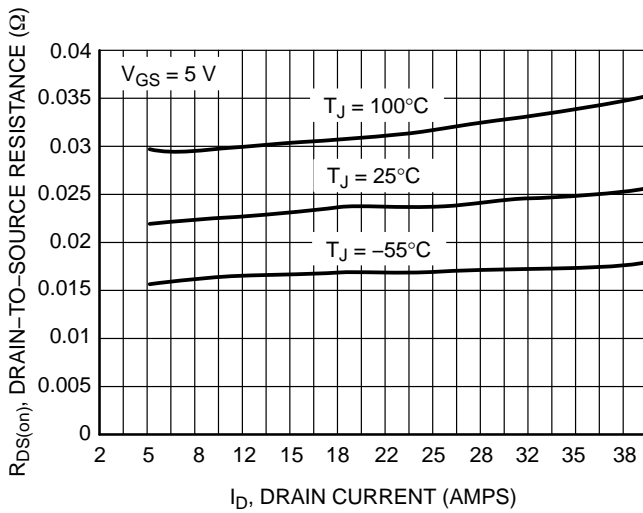

Figure 3. On-Resistance vs. Drain Current and Temperature

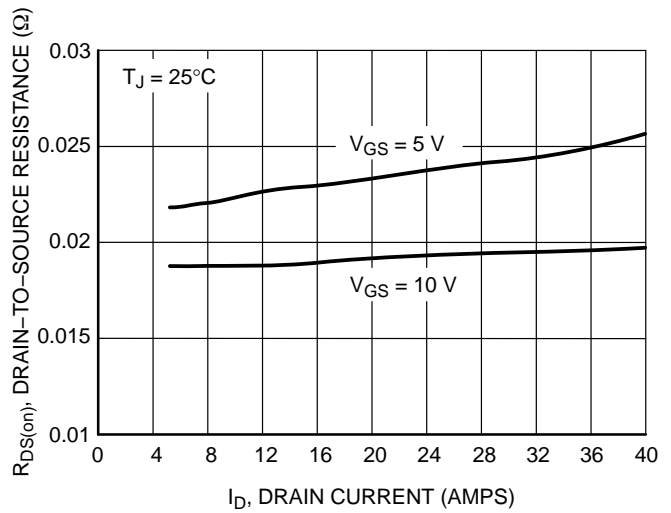

Figure 4. On-Resistance vs. Drain Current and Gate Voltage

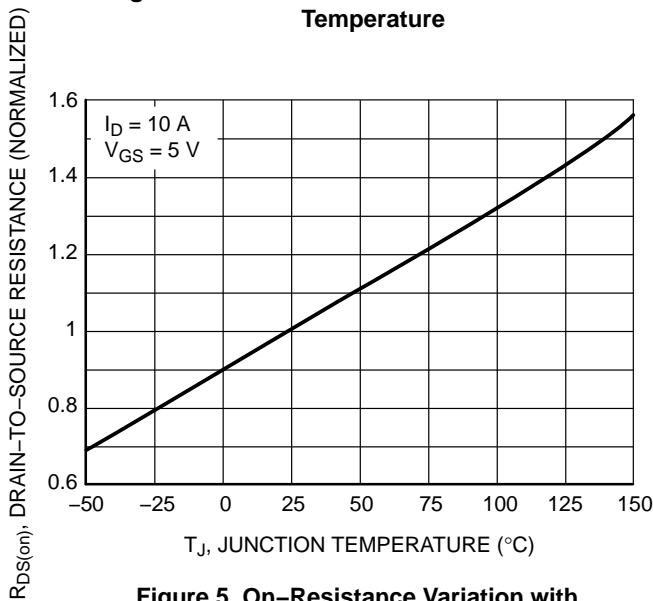

Figure 5. On-Resistance Variation with Temperature

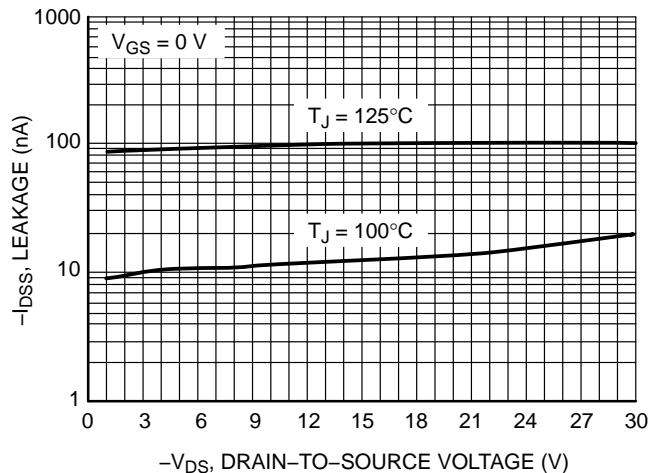

Figure 6. Drain-to-Source Leakage Current vs. Voltage

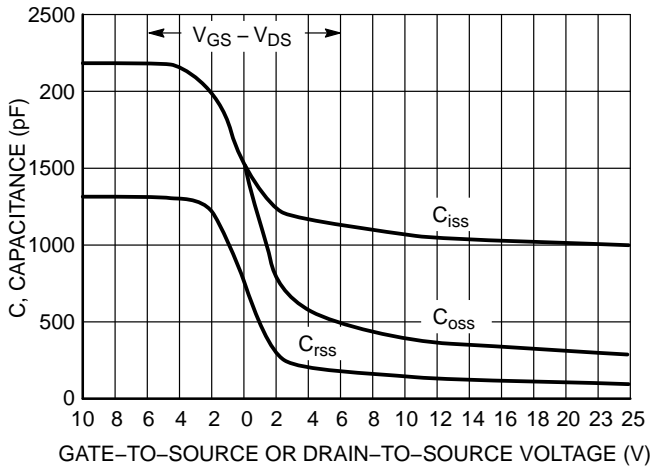

Figure 7. Capacitance Variation

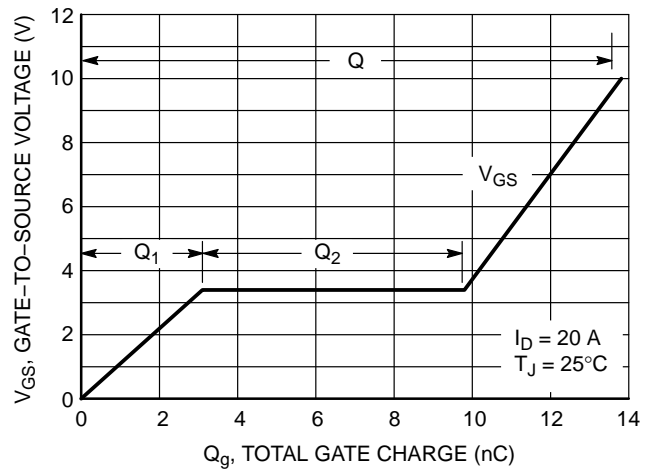

Figure 8. Gate-to-Source and Drain-to-Source Voltage vs. Total Charge

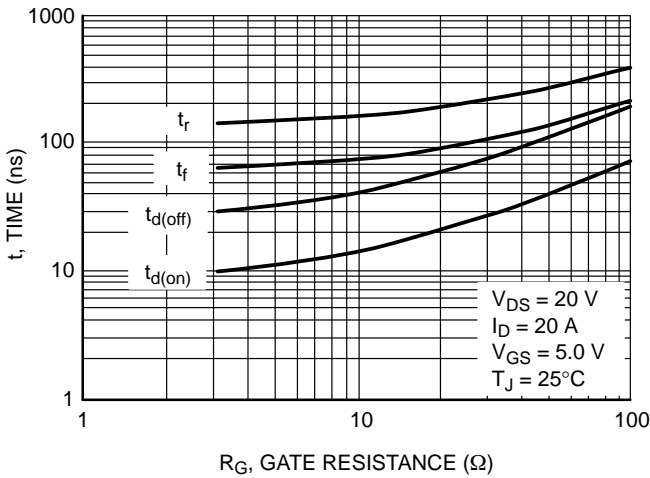

Figure 9. Resistive Switching Time Variation vs. Gate Resistance

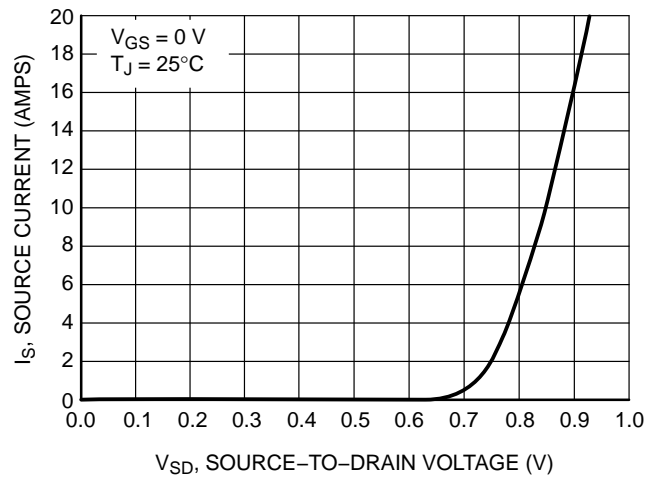

Figure 10. Diode Forward Voltage vs. Current

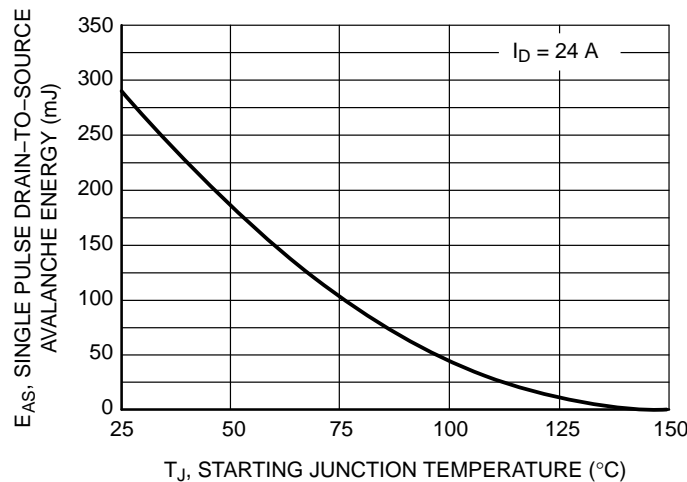
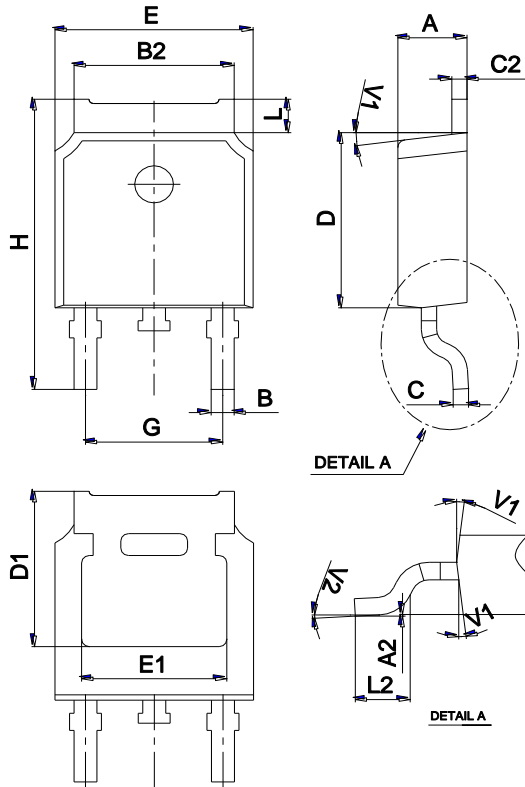

Figure 11. Maximum Avalanche Energy vs. Starting Junction Temperature

Package Mechanical Data TO-252



Ref.	Dimensions					
	Millimeters			Inches		
	Min.	Typ.	Max.	Min.	Typ.	Max.
A	2.10		2.50	0.083		0.098
A2	0		0.10	0		0.004
B	0.66		0.86	0.026		0.034
B2	5.18		5.48	0.202		0.216
C	0.40		0.60	0.016		0.024
C2	0.44		0.58	0.017		0.023
D	5.90		6.30	0.232		0.248
D1	5.30REF			0.209REF		
E	6.40		6.80	0.252		0.268
E1	4.63			0.182		
G	4.47		4.67	0.176		0.184
H	9.50		10.70	0.374		0.421
L	1.09		1.21	0.043		0.048
L2	1.35		1.65	0.053		0.065
V1		7°			7°	
V2	0°		6°	0°		6°

Marking

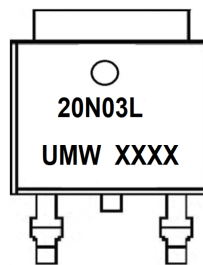

Ordering information

Order code	Package	Baseqty	Deliverymode
UMW NTD20N03L27T4G	TO-252	2500	Tape and reel

单击下面可查看定价，库存，交付和生命周期等信息

[>>UMW\(友台半导体\)](#)