

■ Features

- $V_{DS} (V) = 30V$
- $R_{DS(ON)} < 57m\Omega (V_{GS} = -10V)$
- $R_{DS(ON)} < 94 m\Omega (V_{GS} = -4.5V)$

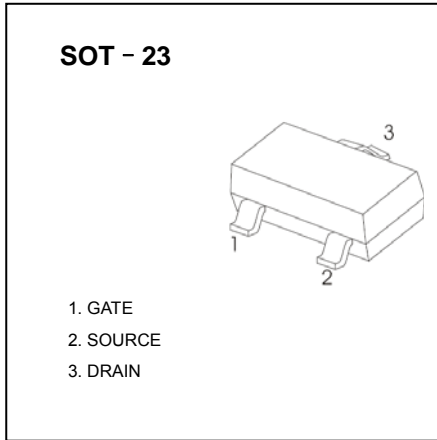

Equivalent Circuit

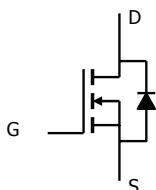

■ Absolute Maximum Ratings $T_a = 25$

Parameter	Symbol	Rating	Unit
Drain-Source Voltage	V_{DS}	30	V
Gate-Source Voltage	V_{GS}	± 20	
Continuous Drain Current $T_j = 150^\circ C$ *1	I_D	$T_a = 25^\circ C$	3.5
		$T_a = 70^\circ C$	2.8
Pulsed Drain Current	I_{DM}	16	A
Power Dissipation *1	P_D	$T_a = 25^\circ C$	1.25
		$T_a = 70^\circ C$	0.8
Thermal Resistance. Junction- to-Ambient	R_{thJA}	$t \leq 5 \text{ sec}$	100
		Steady State	130
Junction Temperature	T_J	150	$^\circ C$
Storage Temperature Range	T_{stg}	-55 to 150	

*1. Surface Mounted on FR4 Board, $t \leq 5 \text{ sec}$

■ Electrical Characteristics Ta = 25°C

Parameter	Symbol	Testconditions	Min	Typ	Max	Unit
Drain-source breakdown voltage	$V_{(BR)DSS}$	$V_{GS} = 0\text{ V}, I_D = 250\text{ }\mu\text{A}$	30			V
Gate threshold voltage	$V_{GS(th)}$	$V_{DS} = V_{GS}, I_D = 250\text{ }\mu\text{A}$	1		3	
Gate-body leakage	I_{GSS}	$V_{DS} = 0\text{ V}, V_{GS} = \pm 20\text{ V}$			± 100	nA
Zero gate voltage drain current	I_{DSS}	$V_{DS} = 30\text{ V}, V_{GS} = 0\text{ V}$			0.5	uA
		$V_{DS} = 30\text{ V}, V_{GS} = 0\text{ V}, T_J = 55\text{ }^\circ\text{C}$			10	
On-state drain current	$I_{D(on)}$	$V_{DS} \geq 4.5\text{ V}, V_{GS} = 10\text{ V}$	6			A
		$V_{DS} \geq 4.5\text{ V}, V_{GS} = 4.5\text{ V}$	4			
Drain-source on-state resistance	$r_{DS(on)}$	$V_{GS} = 10\text{ V}, I_D = 3.5\text{ A}$		0.046	0.057	Ω
		$V_{GS} = 4.5\text{ V}, I_D = 2.8\text{ A}$		0.070	0.094	
Forward transconductance	g_{fs}	$V_{DS} = 4.5\text{ V}, I_D = 3.5\text{ A}$		6.9		S
Diode forward voltage	V_{SD}	$I_S = 1.25\text{ A}, V_{GS} = 0\text{ V}$		0.8	1.2	V
gate charge *	Q_g	$V_{DS} = 15\text{ V}, V_{GS} = 5\text{ V}, I_D = 3.5\text{ A}$		4.2	7	nC
Total gate charge *	Q_{gt}	$V_{DS} = 15\text{ V}, V_{GS} = 10\text{ V}, I_D = 3.5\text{ A}$		8.5	20	nC
Gate-source charge *	Q_{gs}			1.9		
Gate-drain charge *	Q_{gd}			1.35		
Gate Resistance	R_g			0.5		
Input capacitance *	C_{iss}	$V_{DS} = 15\text{ V}, V_{GS} = 0, f = 1\text{ MHz}$		555		pF
Output capacitance *	C_{oss}			120		
Reverse transfer capacitance *	C_{rss}			60		
Turn-on time	$t_{d(on)}$		$V_{DD} = 15\text{ V}, R_L = 15\text{ }\Omega,$ $I_D = 1\text{ A}, V_{GEN} = -10\text{ V}, R_G = 6\text{ }\Omega$		9	
	t_r			7.5	18	
Turn-off time	$t_{d(off)}$			17	35	
	t_f			5.2	12	

* Pulse test: $PW \leq 300\text{ }\mu\text{s}$ duty cycle $\leq 2\%$.

Typical Characteristics

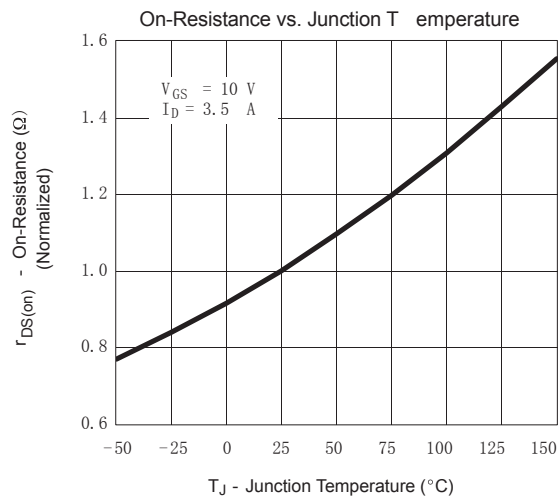
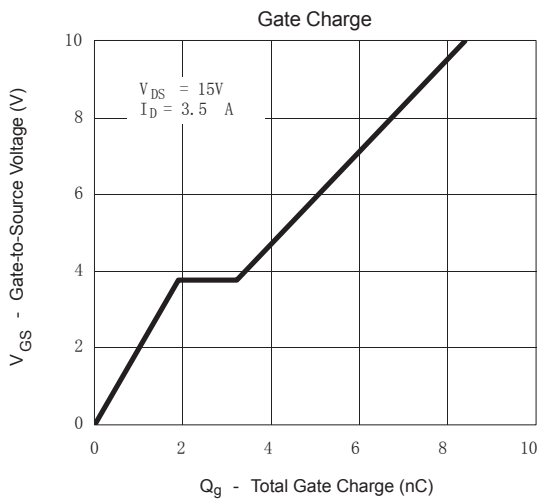
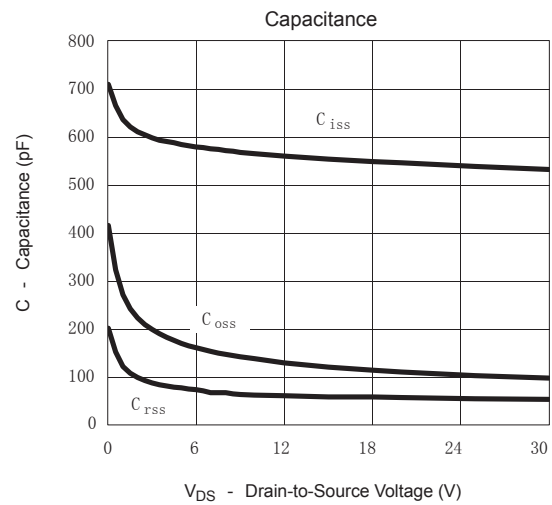
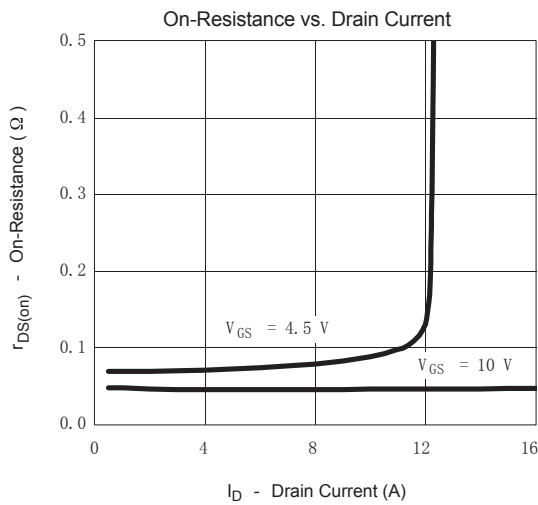
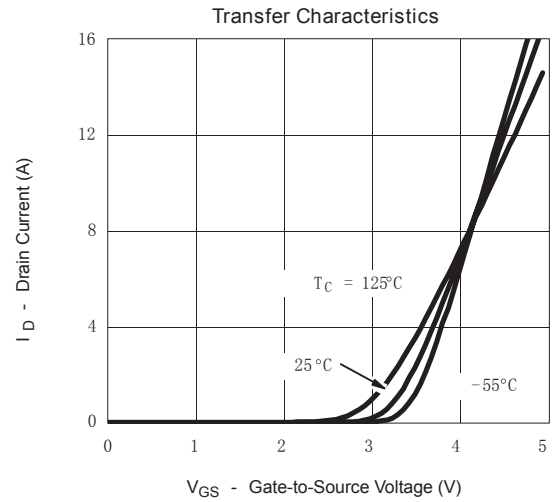
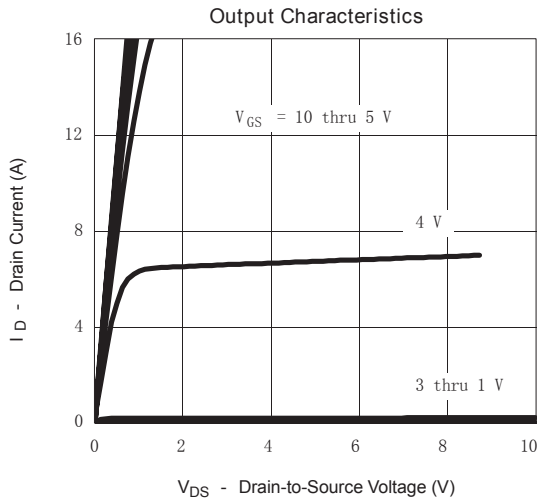

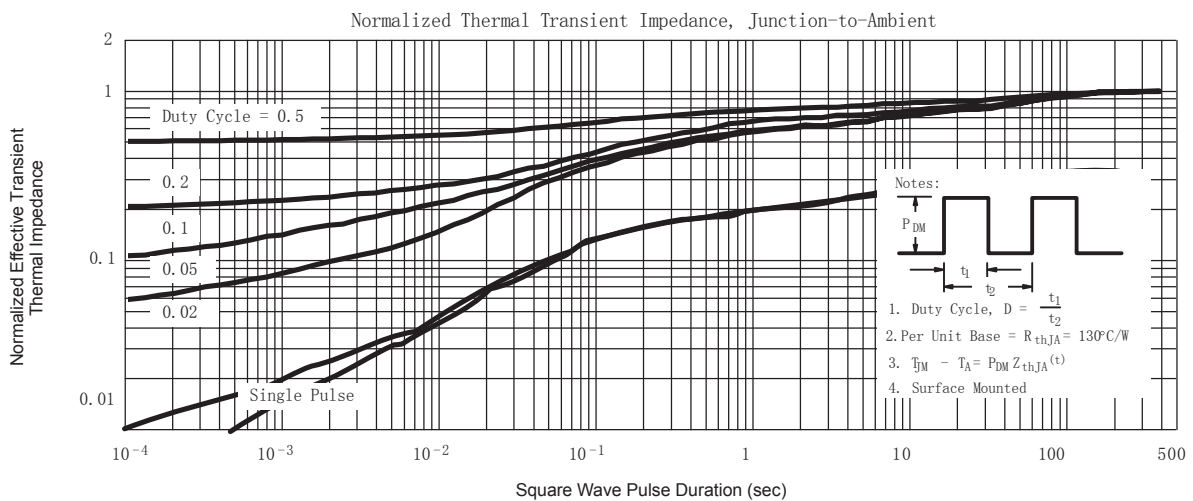
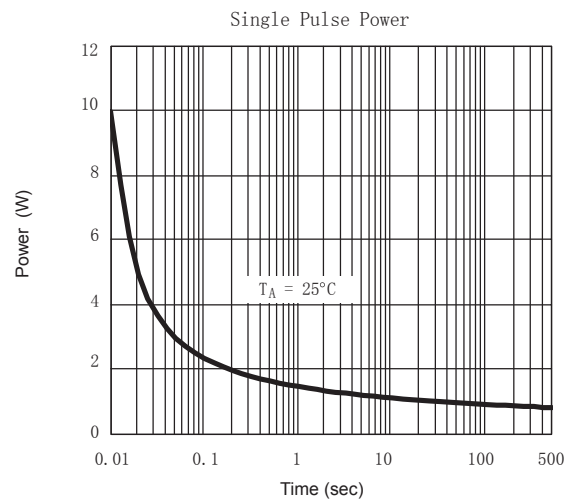
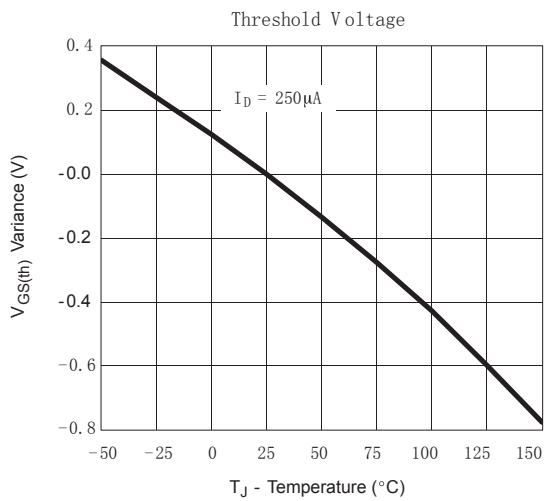
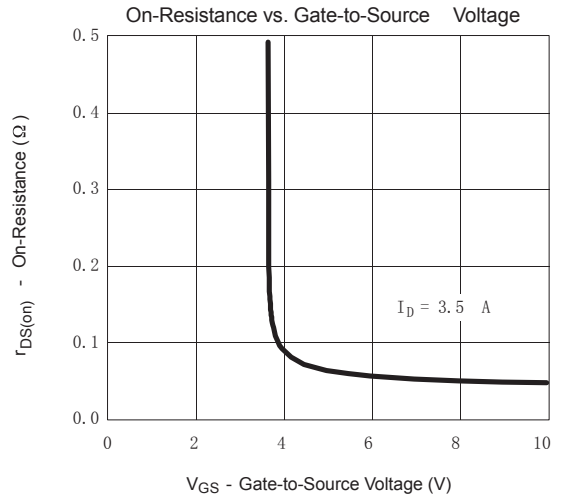
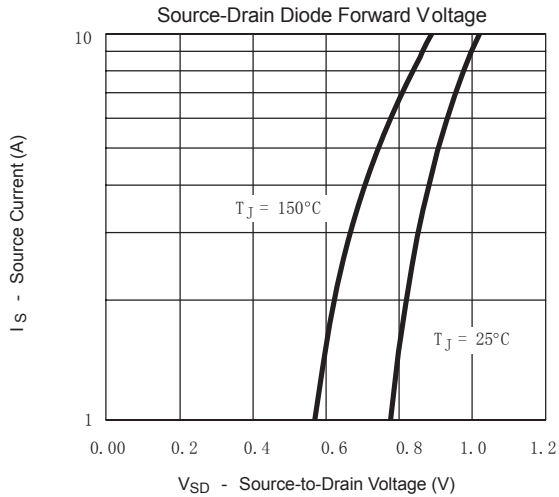

SOT-23 PACKAGE OUTLINE DIMENSIONS

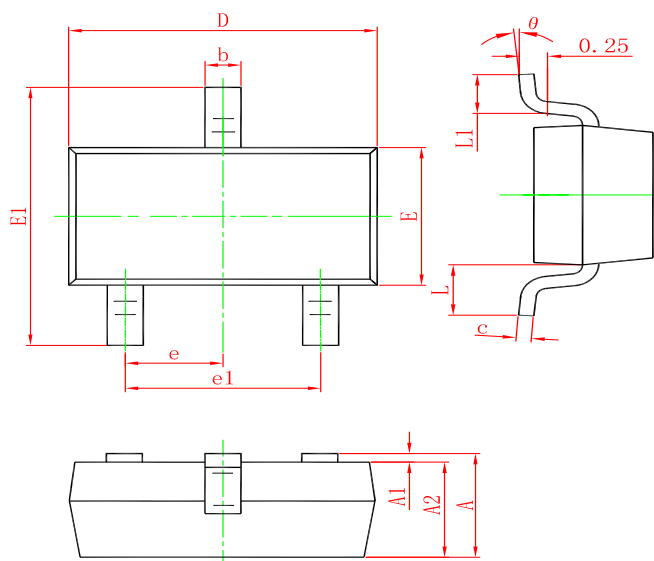

Symbol	Dimensions In Millimeters		Dimensions In Inches	
	Min.	Max.	Min.	Max.
A	0.900	1.150	0.035	0.045
A1	0.000	0.100	0.000	0.004
A2	0.900	1.050	0.035	0.041
b	0.300	0.500	0.012	0.020
c	0.080	0.150	0.003	0.006
D	2.800	3.000	0.110	0.118
E	1.200	1.400	0.047	0.055
E1	2.250	2.550	0.089	0.100
e	0.950 TYP.		0.037 TYP.	
e1	1.800	2.000	0.071	0.079
L	0.550 REF.		0.022 REF.	
L1	0.300	0.500	0.012	0.020
θ	0°	8°	0°	8°

Marking

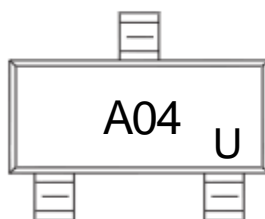

Ordering information

Order code	Package	Baseqty	Deliverymode
UMW SI2304A	SOT-23	3000	Tape and reel

单击下面可查看定价，库存，交付和生命周期等信息

[>>UMW\(友台半导体\)](#)