

■ Features

- Extremely Fast Switching Speed
- Low forward voltage

■ Simplified outline(SOT-323)

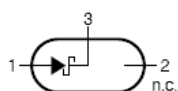
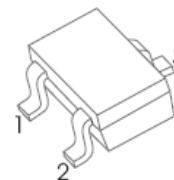

**BAT54W**

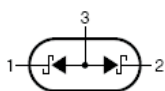

**BAT54AW**

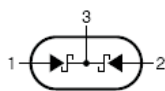

**BAT54CW**

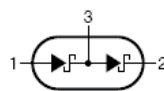

**BAT54SW**

■ Absolute Maximum Ratings  $T_a = 25^\circ\text{C}$

Parameter	Symbol	Rating	Unit
Peak Repetitive Reverse Voltage	$V_{RRM}$	30	V
Working Peak Reverse Voltage	$V_{RWM}$		
DC Blocking Voltage	$V_R$		
Forward Continuous Current	$I_{FM}$	200	mA
Non-repetitive Peak Forward Surge Current @ $t=8.3\text{ms}$	$I_{FSM}$	600	
Repetitive Peak Forward Current @ $t \leq 1\text{s}, \delta \leq 0.5$	$I_{FRM}$	300	
Power Dissipation	$P_D$	200	mW
Thermal Resistance Junction to Ambient	$R_{\theta JA}$	500	$^\circ\text{C}/\text{W}$
Junction Temperature	$T_J$	125	$^\circ\text{C}$
Storage Temperature range	$T_{stg}$	-55 to 150	

■ Electrical Characteristics  $T_a = 25^\circ\text{C}$

Parameter	Symbol	Test Conditions	Min	Typ	Max	Unit
Reverse Voltage	$V_{(BR)}$	$I_R = 100 \mu\text{A}$	30			V
Forward Voltage	$V_{F1}$	$I_F = 0.1 \text{ mA}$			0.24	
	$V_{F2}$	$I_F = 1 \text{ mA}$			0.32	
	$V_{F3}$	$I_F = 10 \text{ mA}$			0.40	
	$V_{F4}$	$I_F = 30 \text{ mA}$			0.50	
	$V_{F5}$	$I_F = 100 \text{ mA}$			1	
Leakage Current	$I_R$	$V_R = 25 \text{ V}$			2	$\mu\text{A}$
Diode Capacitance	$C_D$	$V_R = 0 \text{ V}, f = 1 \text{ MHz}$			10	pF
Reverse Recovery Time	$t_{rr}$	$I_F = I_R = 10 \text{ mA}, I_{rr} = 0.1 \times I_R, R_L = 100 \Omega$			5	ns

■ Typical Characteristics

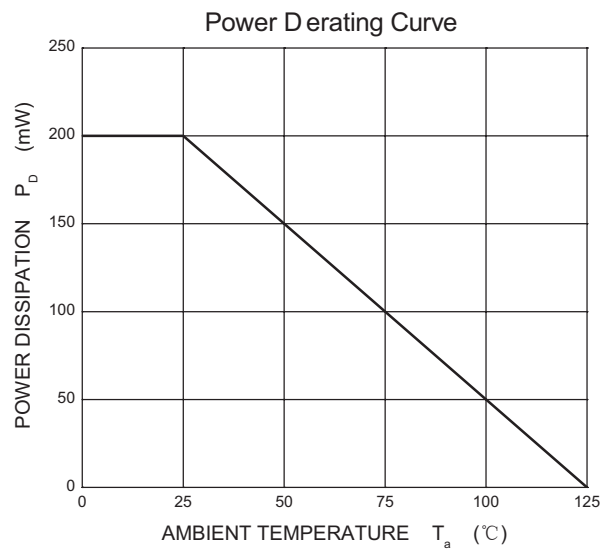
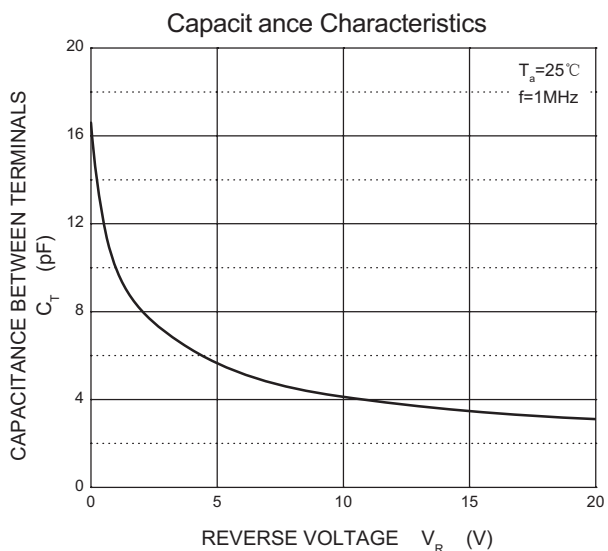
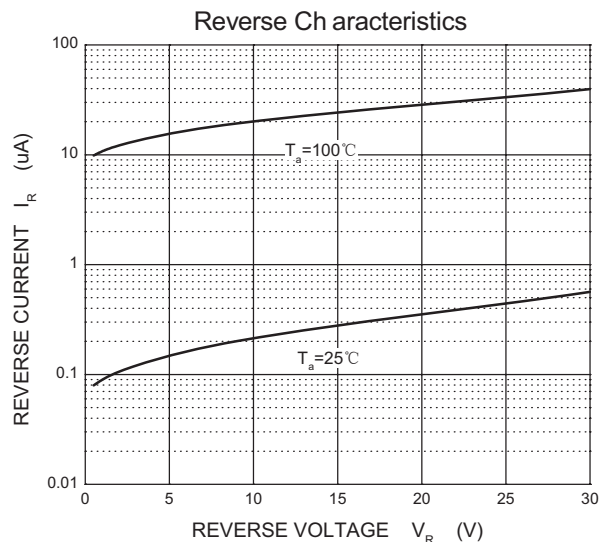
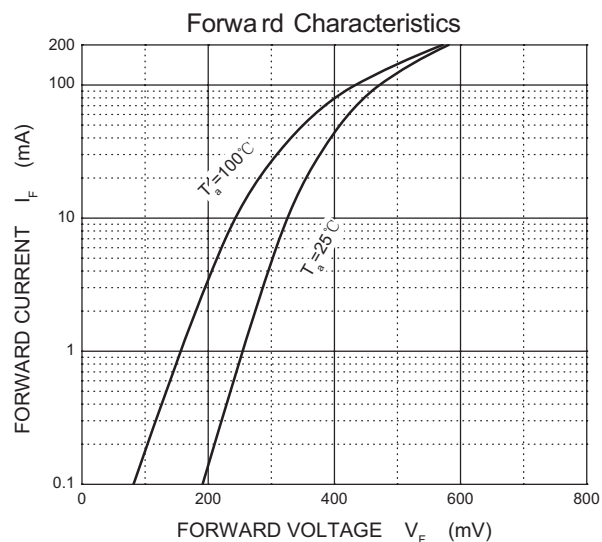

■ SOT-323

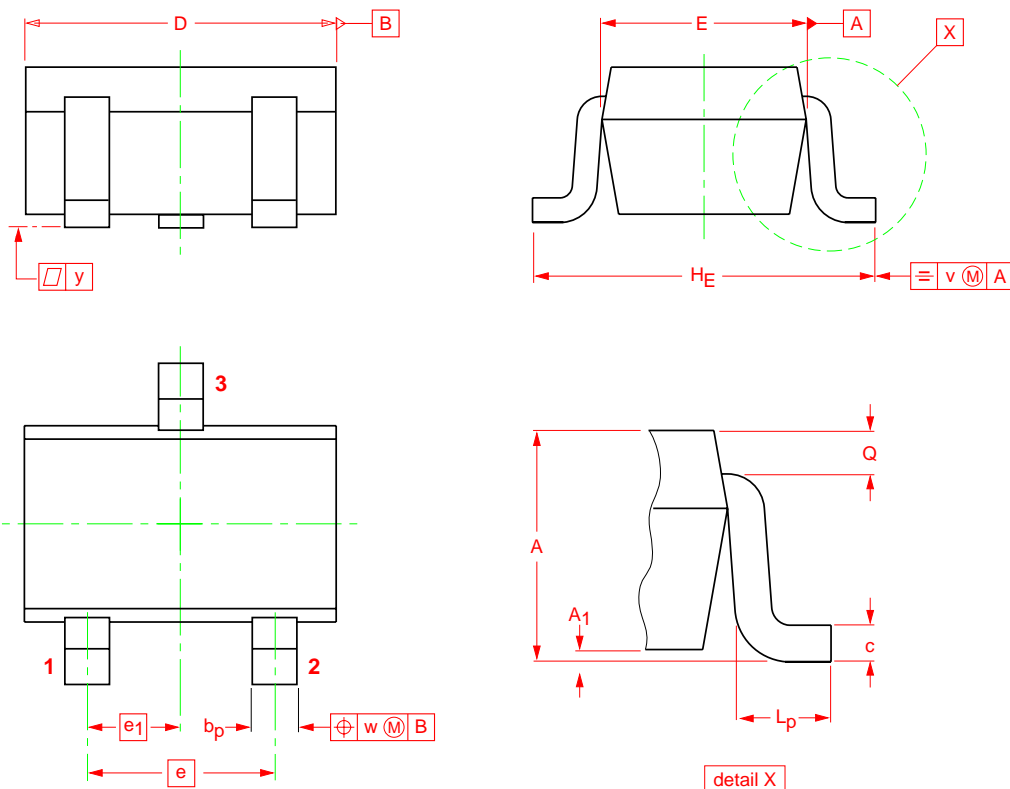

DIMENSIONS (mm are the original dimensions)

UNIT	A	A <sub>1</sub> max	b <sub>p</sub>	c	D	E	e	e <sub>1</sub>	H <sub>E</sub>	L <sub>p</sub>	Q	v	w
mm	1.1 0.8	0.1	0.4 0.3	0.25 0.10	2.2 1.8	1.35 1.15	1.3	0.65	2.2 2.0	0.45 0.15	0.23 0.13	0.2	0.2

■ Ordering information

Order Code	Package	Baseqty	Marking	Deliverymode
UMW BAT54W	SOT-323	3000	KL5 or L4	Tape and reel
UMW BAT54AW	SOT-323	3000	KL6 or L42	Tape and reel
UMW BAT54CW	SOT-323	3000	KL7 or L43	Tape and reel
UMW BAT54SW	SOT-323	3000	KL8 or L44	Tape and reel

单击下面可查看定价，库存，交付和生命周期等信息

[>>UMW\(友台半导体\)](#)